



Tools Equipment and Metals 2016-2017



Tools, Equipment and Metals
2016-2017



Tools, Equipment and Metals

Published by Stuller, Inc. ©2015

302 Rue Louis XIV

Lafayette, LA 70508 USA

Phone 337 262 7700

Stuller.com

When Stuller was founded in 1970, Matt Stuller set out to satisfy the customer. Today, 45 years later, that same vision holds true.

Stuller has been beside you over the years, growing product lines tailored to your needs and creating more ways to help you succeed. We have an extensive inventory that includes fashion jewelry, bridal jewelry, diamonds, gemstones, mountings, findings, tools, metals, packaging and displays. You are sure to find everything you need, every time.

Often, you need more than stylish products. So, we design sales aids for just this purpose. Use Stuller.com to get real-time product information available 24/7. Enhancing your tried and true selling techniques with digital solutions is the new world of doing business.

Your success is our ultimate goal.



Table of Contents

IMPORTANT SYMBOLS



Safety Glasses



Safety Mask



Respirator Recommended



Proper Ventilation



First Aid



Eye Wash Station



Flammable



Recommended RPMs



Lift Gate Required



Hazardous Shipping



Hazardous Shipping Does Not Apply



Number of Pieces Sold by Unit



Weight



Video Available Online



Stuller Exclusive Product



Tried, Tested & Used by Stuller

4	Abrasives
36	Adhesives
40	Bags and Envelopes
44	Batteries
53	Beading and Stringing Supplies
78	Benches and Bench Tools
99	Brushes
108	Burs
134	Casting
192	Cleaning
210	Drills and Punches
220	Engraving
252	Files
266	Flex Shafts
280	Gauges and Mandrels
293	Gemological Instruments
304	Hammers
312	Lamps
318	Loupes and Magnifiers
330	Metals
374	Metal Drawing and Forming
387	Plating Supplies
403	Pliers, Cutters and Shears
430	Polishing
472	Ring Sizers and Stretchers
474	Safety Supplies
482	Saw Blades and Frames
488	Scales
496	Screwdrivers
500	Soldering Supplies and Torches
530	Testers
538	Tweezers
549	Videos and Books
554	Watch Tools and Supplies
580	Ordering Information
582	Safety Information
584	Conversion Charts
587	Product Index
590	Numerical Index

Abrasives

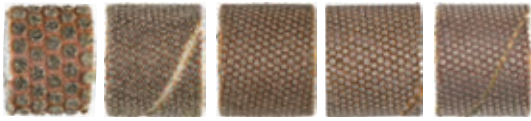

FLEX DIAMOND BANDS

Excellent for inside ring cleaning, shaping, and carving. They can be used wet or dry on both metals and stones. Cuts sanding time in half. These bands should be used on the expanding drum mandrels 43-1262 or 43-1266.



Order #	Grit	OD x Length	Micron	12+	6+	1+
10-8090	60	1/2" x 1/2"	250 μ	\$5.43	\$5.66	\$5.90
10-8091	120	1/2" x 1/2"	125 μ	\$5.43	\$5.66	\$5.90
10-8092	200	1/2" x 1/2"	74 μ	\$5.43	\$5.66	\$5.90
10-8093	400	1/2" x 1/2"	40 μ	\$5.43	\$5.66	\$5.90
10-8094	800	1/2" x 1/2"	20 μ	\$5.43	\$5.66	\$5.90



CUBITRON CERAMIC ABRASIVES

These purple bands are coated with a ceramic aluminum-oxide mineral, which is very aggressive and the toughest on the market. They provide longer life, great finish, and dust control all wrapped into one. These bands should be used on the drum mandrels 43-1262 or 43-1266.



Order #	Grit	OD x Length	12+	6+	1+
10-6000	42-Piece Assortment with Mandrel		\$25.97	\$27.50	\$30.55
10-6100	60	1/2" x 1/2"	\$13.57	\$14.16	\$14.75
10-6102	80	1/2" x 1/2"	\$13.57	\$14.16	\$14.75
10-6103	120	1/2" x 1/2"	\$13.57	\$14.16	\$14.75
10-6104	220	1/2" x 1/2"	\$13.57	\$14.16	\$14.75



DIAMOND MICRO-FINISHING POLISHING BANDS

The Diamond Micro bands are designed to improve productivity and reduce the cost of finishing. Durable yet flexible due to its unique film design.

Order #	Grit	OD x Length	12+	6+	1+
10-8420	21-Piece Assortment with Mandrel (5 of each grit)		\$43.84	\$45.74	\$47.65
10-8407	220	1/2" x 1/2"	\$2.84	\$3.20	\$3.55
10-8408	320	1/2" x 1/2"	\$2.84	\$3.20	\$3.55
10-8409	400	1/2" x 1/2"	\$2.84	\$3.20	\$3.55
10-8410	600	1/2" x 1/2"	\$2.84	\$3.20	\$3.55



SILICONE-CARBIDE SANDING BANDS

Excellent for miniature sanding. These high-quality, bands outlast most other silicon carbide abrasive bands on the market and use special rubber, expanding head mandrels.



Order #	Grit	OD x Length	12+	6+	1+
10-8075	80	1/2" x 1/2"	\$7.82	\$8.16	\$8.50
10-8076	120	1/2" x 1/2"	\$7.82	\$8.16	\$8.50
10-8077	180	1/2" x 1/2"	\$7.82	\$8.16	\$8.50
10-8078	240	1/2" x 1/2"	\$7.82	\$8.16	\$8.50
10-8079	320	1/2" x 1/2"	\$7.82	\$8.16	\$8.50
10-8081	120	1/2" x 1/2"	\$7.82	\$8.16	\$8.50
10-8082	180	1/2" x 1/2"	\$7.82	\$8.16	\$8.50

ALUMINUM-OXIDE SANDING BANDS

Aluminum-oxide sanding bands provide a fast and smooth cut rate and can be used for cleanup and pre-polish work. These sanding bands are durable and last longer than most other bands.



Order #	Grit	OD x Length	12+	6+	1+
10-8100	80	1/2" x 1"	\$8.14	\$8.50	\$8.85
10-8101	120	1/2" x 1"	\$8.14	\$8.50	\$8.85
10-8102	180	1/2" x 1"	\$8.14	\$8.50	\$8.85
10-8103	240	1/2" x 1"	\$8.14	\$8.50	\$8.85
10-8104	320	1/2" x 1"	\$8.14	\$8.50	\$8.85
10-8105	80	1/2" x 1/2"	\$8.23	\$8.59	\$8.95
10-8106	120	1/2" x 1/2"	\$8.23	\$8.59	\$8.95
10-8107	180	1/2" x 1/2"	\$8.23	\$8.59	\$8.95
10-8108	240	1/2" x 1/2"	\$8.23	\$8.59	\$8.95
10-8109	320	1/2" x 1/2"	\$8.23	\$8.59	\$8.95
10-8110	80	1/4" x 1/2"	\$8.14	\$8.50	\$8.85
10-8111	120	1/4" x 1/2"	\$8.23	\$8.59	\$8.95
10-8112	180	1/4" x 1/2"	\$8.23	\$8.59	\$8.95
10-8113	240	1/4" x 1/2"	\$8.23	\$8.59	\$8.95
10-8114	320	1/4" x 1/2"	\$8.14	\$8.50	\$8.85
10-8115	80	3/8" x 1/2"	\$8.14	\$8.50	\$8.85
10-8116	120	3/8" x 1/2"	\$8.23	\$8.59	\$8.95
10-8117	240	3/8" x 1/2"	\$8.23	\$8.59	\$8.95

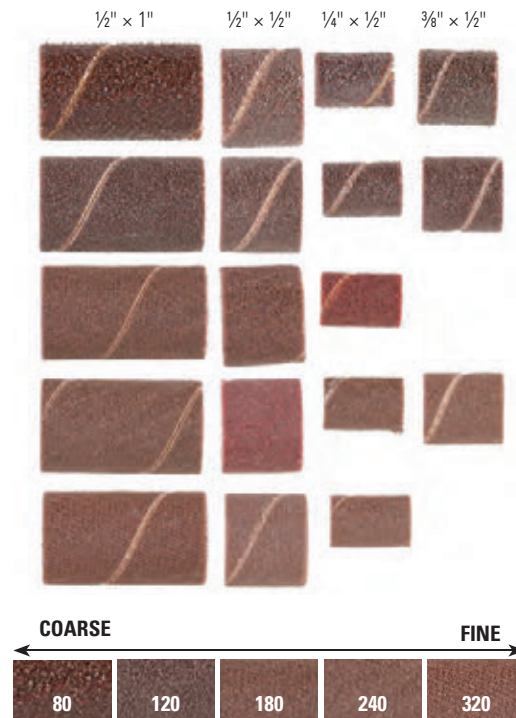

DRUM ARBORS FOR ABRASIVE BANDS

Solid, rubber drums mounted on steel arbors expand to hold abrasive bands snugly. The cushioned drum allows the abrasive band to leave an even cut and a smooth finish.

Item	Order #	OD x Length	Shank Size	12+	6+	1+
A	43-1260	1/2" x 1/4"	3/32"	\$1.98	\$2.06	\$2.15
B	43-1261	1/2" x 3/8"	3/32"	\$2.07	\$2.16	\$2.25
C	43-1262	1/2" x 1/2"	3/32"	\$2.07	\$2.16	\$2.25
	43-1264	1/2" x 1/4"	1/8"	\$2.07	\$2.16	\$2.25
43-1265	1/2" x 3/8"	1/8"	\$2.07	\$2.16	\$2.25	
43-1266	1/2" x 1/2"	1/8"	\$2.21	\$2.30	\$2.40	
43-1267	1" x 1/2"	1/8"	\$4.14	\$4.32	\$4.50	



RUBBER SANDING DRUM MANDRELS

Solid drum mandrels expand to hold abrasive bands tightly.

Order #	OD x Length	Shank Size	12+	6+	1+	
D	43-1272	1/4" x 1/2"	3/32"	\$3.83	\$4.05	\$4.50
E	43-1273	3/8" x 1/2"	3/32"	\$3.83	\$4.05	\$4.50
F	43-1274	1/2" x 1/2"	3/32"	\$3.83	\$4.05	\$4.50
	43-1275	1/4" x 1/2"	1/8"	\$3.83	\$4.05	\$4.50
43-1276	3/8" x 1/2"	1/8"	\$3.83	\$4.05	\$4.50	
43-1277	1/2" x 1/2"	1/8"	\$3.83	\$4.05	\$4.50	

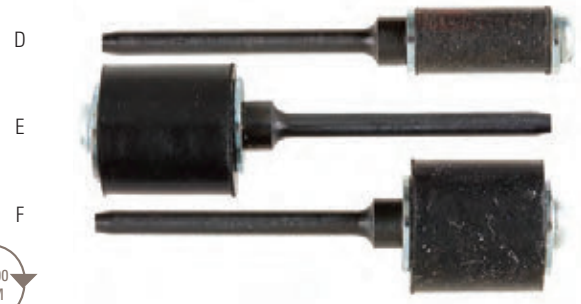

Left-hand threaded for running in reverse operation.

43-1279	1/2" x 1/2"	3/32"	\$7.22	\$7.54	\$7.85
---------	-------------	-------	--------	--------	--------

Abrasives



3M® ALUMINUM-OXIDE CARTRIDGE ROLLS

Achieve consistent, uniform surface finishes with these aluminum-oxide abrasive paper rolls. Simply cut away the used abrasive material to expose a new sanding surface. Rolls are conveniently mounted on a 3/32" mandrel.



Order #	Grit	OD x Length	12+	6+	1+
10-6090	240	1/2" x 2 3/8"	\$6.04	\$6.39	\$7.10
10-6091	320	1/2" x 2 3/8"	\$6.04	\$6.39	\$7.10
10-6092	400	1/2" x 2 3/8"	\$6.04	\$6.39	\$7.10
10-6093	600	1/2" x 2 3/8"	\$6.04	\$6.39	\$7.10
10-6094	800	1/2" x 2 3/8"	\$6.04	\$6.39	\$7.10
10-6095	1000	1/2" x 2 3/8"	\$5.87	\$6.21	\$6.90



3M® ALUMINUM-OXIDE CARTRIDGE ROLLS

These cartridge rolls, available in regular and full tapered, provide an economical way of sanding. Layers of the cartridge roll break down, exposing a new sanding surface while sanding.



Order #	Grit	OD x Length	12+	6+	1+
10-8150	60	1/2" x 3/4"	\$13.66	\$14.26	\$14.85
10-8122	80	1/2" x 3/4"	\$13.48	\$14.06	\$14.65
10-8123	120	1/2" x 3/4"	\$13.62	\$14.21	\$14.80
10-8124	180	1/2" x 3/4"	\$13.62	\$14.21	\$14.80
10-8125	240	1/2" x 3/4"	\$13.62	\$14.21	\$14.80
10-8126	320	1/2" x 3/4"	\$13.62	\$14.21	\$14.80
10-8151	60	1/2" x 1"	\$15.59	\$16.27	\$16.95
10-8152	80	1/2" x 1"	\$15.59	\$16.27	\$16.95
10-8153	120	1/2" x 1"	\$15.59	\$16.27	\$16.95
10-8155	180	1/2" x 1"	\$15.59	\$16.27	\$16.95
10-8131	240	1/2" x 1"	\$15.50	\$16.18	\$16.85
10-8132	320	1/2" x 1"	\$15.50	\$16.18	\$16.85

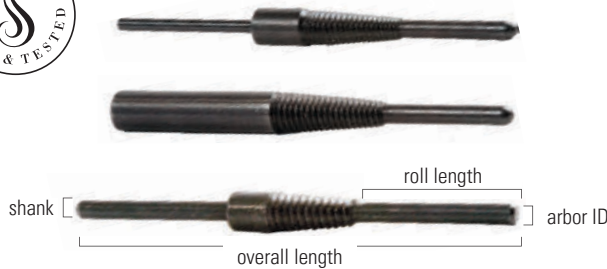

CARTRIDGE-ROLL MANDRELS

Specially made mandrel to accommodate abrasive cartridge rolls.

Order #	Arbor ID	Roll Length	Length	Shank	12+	6+	1+
11-2205	1/8"	2 3/4"	1 1/2"	1/8"	\$3.17	\$3.31	\$3.45
11-2204	1/8"	2 1/2"	1 1/2"	1/4"	\$3.17	\$3.31	\$3.45
11-2203	1/8"	2 3/4"	1 1/2"	3/32"	\$3.17	\$3.31	\$3.45

SANDING MANDRELS

Developed by Kate Wolf for sanding and finishing the inside of rings and made of stainless steel. These mandrels are machined true and come with rubber bands to hold the emery paper in place.



Order #	OD x Length	Shank Size	Assortment Quantity	12+	6+	1+
21-0498		5/8"	Set of 3	\$8.59	\$9.09	\$10.10
21-0452	3mm x 1/4"	5/8"	Each	\$2.47	\$2.61	\$2.90
21-0453	3mm x 3/8"	5/8"	Each	\$2.72	\$2.88	\$3.20
21-0003	4mm x 1/2"	5/8"	Each	\$3.78	\$4.01	\$4.45

EMERY PAPER OR CLOTH, INSIDE RING SHELLS

Drilled for a tapered spindle and used to polish and smooth ring insides. Fits over wood mandrel.



Order #	Grade	Material	12+	6+	1+
11-3200	4/0 (Finest)	Paper	\$16.10	\$16.80	\$17.50
11-3201	3/0	Paper	\$16.10	\$16.80	\$17.50
11-3202	2/0	Paper	\$16.10	\$16.80	\$17.50
11-3203	1/0	Paper	\$16.10	\$16.80	\$17.50
11-3204	1	Paper	\$16.10	\$16.80	\$17.50
11-3205	2	Paper	\$16.10	\$16.80	\$17.50
11-3206	3 (Coarsest)	Paper	\$16.10	\$16.80	\$17.50
11-3100	4/0	Cloth	\$14.67	\$15.31	\$15.95
11-3101	2/0	Cloth	\$14.67	\$15.31	\$15.95
11-3102	1	Cloth	\$14.67	\$15.31	\$15.95
11-3103	3	Cloth	\$14.67	\$15.31	\$15.95



EMERY SHELL KIT

Assorted grits with wooden cone mandrel. Grits are 4/0, 3/0, 2/0, 1/0, 1, 2.

Order #	Description	12+	6+	1+
11-3110	Emery Shell Kit (pack of 6)	\$5.50	\$6.28	\$7.85



WOOD ARBOR

A. Can be used as a 6" polishing stick once coated with adhesive and rolled in abrasive. Arbor hole measures 1/4" for tapered spindle mounting. Made of birch wood.

WOOD MANDREL

B. Used with emery shells that are held by friction. Can also be used as a holder for rings, chains, and other items when polishing.

SPLIT WOOD MANDREL - SPINDLE

C. Insert into the slot of the wood mandrel to create an emery flat wheel. Mandrel fits any tapered shaft. Made of birch wood.

Item	Order #	Description	OD	Length	12+	6+	1+
A	11-2660	Wood Arbor	1/4"	7"	\$1.66	\$1.73	\$1.80
B	11-3330	Wood Mandrel		4"	\$1.01	\$1.06	\$1.10
C	11-3060	Split Wood Mandrel	1/8"	4 1/4"	\$1.29	\$1.34	\$1.40

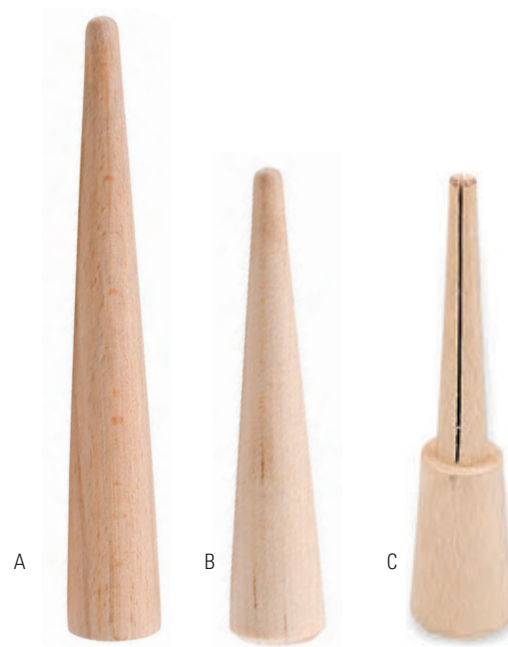

Abrasives

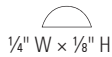

Half-Round



Triangle



Round



SHAPED SANDING STICKS

Sanding sticks can be used before you buff or polish a piece to help smooth out deep scratches and surface marring. They can be used to remove corrosion, rust, or other build-up. Many jewelers like them for use on unfired metal clay as well. They are designed so the emery paper is glued to wooden handles to make them easy to hold and easy to use. The wooden handles measure 9/4" and are approximately 7/16" diameter. These emery sanding sticks come in three different grits running from 2/0 (finest) to 3 (coarsest) and three different shapes with so many uses. Sets of 3 also available. Set pricing not shown.

Item	Order #	Grit	Grade	12+	6+	1+
A	11-3390	180	3 Coarse	\$2.10	\$2.40	\$3.00
	11-3390	280	0 Medium	\$2.10	\$2.40	\$3.00
	11-3390	1000	2/0 Fine	\$2.10	\$2.40	\$3.00
B	11-3391	180	3 Coarse	\$2.10	\$2.40	\$3.00
	11-3391	280	0 Medium	\$2.10	\$2.40	\$3.00
	11-3391	1000	2/0 Fine	\$2.10	\$2.40	\$3.00
C	11-3392	1000	2/0 Fine	\$2.55	\$2.70	\$3.00
	11-3392	280	0 Medium	\$2.55	\$2.70	\$3.00
	11-3392	180	3 Coarse	\$2.55	\$2.70	\$3.00



SANDING STICKS

Handy sanding sticks with molded plastic handles. Both sizes sold with 120 (medium) grit cloth-back sandpaper strips (11" long).

Item	Order #	Description	Grit	Width	12+	6+	1+
D	11-3502	Sanding Stick (Set)	120	1/2"	\$8.33	\$8.82	\$9.80
E	11-3503	Sanding Stick (Set)	120	1"	\$8.33	\$8.82	\$9.80
	11-3504	Refill Pack (pack of 10)	120	1/2"	\$5.14	\$5.45	\$6.05
	11-3505	Refill Pack (pack of 10)	120	1"	\$5.10	\$5.40	\$6.00
F	11-3500	Sanding Stick: 1 of each	120, 240	1"	\$13.89	\$14.50	\$15.10
	11-3501	Refill Pack: 1 of each	80, 120, 240	1"	\$7.08	\$7.39	\$7.70



EMERY STICK

Emery paper adhered to wood handles for convenient sanding.

Item	Order #	Grade	W x L	12+	6+	1+
G	11-3400	4/0	3/4" x 9 1/2"	\$0.92	\$1.03	\$1.15
H	11-3401	3/0	3/4" x 9 1/2"	\$0.92	\$1.03	\$1.15
J	11-3402	2/0	3/4" x 9 1/2"	\$0.92	\$1.03	\$1.15
K	11-3403	0	3/4" x 9 1/2"	\$0.92	\$1.03	\$1.15
L	11-3404	1	3/4" x 9 1/2"	\$0.92	\$1.03	\$1.15
M	11-3405	2	3/4" x 9 1/2"	\$0.92	\$1.03	\$1.15
N	11-3406	3	3/4" x 9 1/2"	\$0.92	\$1.03	\$1.15



ABRASIVE BOARDS

Quality abrasive sanding paper is mounted on both sides of this flexible foam board. Ideal for filing, shaping and smoothing, this file is designed to reach easily into confined areas and in or around contours. Use wet or dry on metal and metal clay. This assortment includes six boards, one each of six grits: 3000, 2500, 2000, 1200, 800 and 400.



Order #	Description	Grit	12+	6+	1+
11-3430	Abrasive Board Kit (Assorted Colors)		\$7.32	\$8.24	\$9.15
11-3431	Red Abrasive Board	400	\$1.60	\$1.80	\$2.00
11-3431	Green Abrasive Board	800	\$1.60	\$1.80	\$2.00
11-3431	Blue Abrasive Board	1200	\$1.60	\$1.80	\$2.00
11-3431	Orange Abrasive Board	2000	\$1.60	\$1.80	\$2.00
11-3431	Yellow Abrasive Board	2500	\$1.60	\$1.80	\$2.00
11-3431	White Abrasive Board	3000	\$1.60	\$1.80	\$2.00

SANDPAPER STICKS

Provides a fast, easy, and economical way to access detailed, hard-to-reach areas. The 6¼" long, tapered, plastic sticks hold a replaceable ¼" (6.4mm) wide sanding belt. The aluminum-oxide belt is held in place by a patented, spring-loaded mechanism that allows the belt to be rotated 360°, exposing a new sanding surface.



Order #	Description	Grit	Per Pack	12+	6+	1+
11-3520	Red Stick	120	Each	\$2.07	\$2.16	\$2.25
11-3521	Blue Stick	240	Each	\$2.07	\$2.16	\$2.25
11-3522	Green Stick	320	Each	\$2.07	\$2.16	\$2.25
11-3523	Yellow Stick	400	Each	\$2.07	\$2.16	\$2.25
11-3524	Black Stick	600	Each	\$2.07	\$2.16	\$2.25
11-3525	Belt for Red	120	Pack of 10	\$8.56	\$8.93	\$9.30
11-3526	Belt for Blue	240	Pack of 10	\$8.56	\$8.93	\$9.30
11-3527	Belt for Green	320	Pack of 10	\$8.56	\$8.93	\$9.30
11-3528	Belt for Yellow	400	Pack of 10	\$8.56	\$8.93	\$9.30
11-3529	Belt for Black	600	Pack of 10	\$7.91	\$8.37	\$9.30





120	320	240	180
-----	-----	-----	-----

UTILITY CLOTH ROLL

Professional shop rolls feature high-quality, aluminum-oxide mineral and bonded cloth backings for long abrasive life. A full, resin-over-resin bond construction gives an aggressive cut while providing improved mineral anchorage. 320 grit suitable for applications of ferrous metals.



Order #	Grit	W x L	12+	6+	1+
10-4551	120	1" x 50 yards	\$21.63	\$22.91	\$25.45
10-4554	320	1" x 50 yards	\$40.99	\$42.77	\$44.55
10-4553	240	1" x 50 yards	\$21.63	\$22.91	\$25.45
10-4552	180	1" x 50 yards	\$21.63	\$22.91	\$25.45

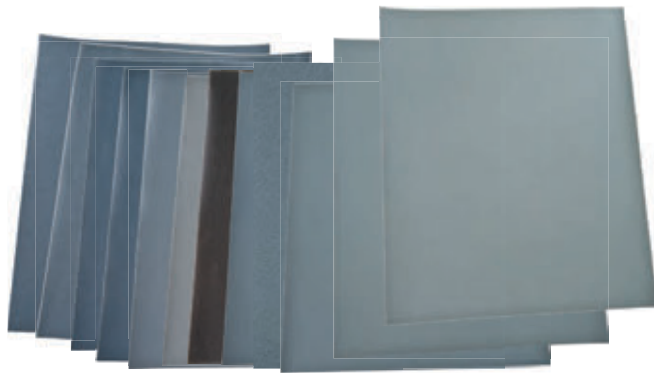

180	220	280	320	400	600
800	1000	1200	1500	2000	2500

3M® IMPERIAL ABRASIVE SHEETS

Abrasive sheets use a special bonding technique that allows more uniform cutting and is highly wear-resistant. These sheets feature a water-proof, resin-over-resin bond that resists heat and holds abrasive particles. All sheets are silicon carbide and can be used wet or dry. Can be used with split wood mandrel 11-3060 or split mandrels for handpieces 11-3008 and 11-3009.

Order #	Grit	W x L	12+	6+	1+
11-0700	180	9" x 11"	\$1.11	\$1.17	\$1.30
11-0701	220	9" x 11"	\$1.11	\$1.17	\$1.30
11-0702	280	9" x 11"	\$1.11	\$1.17	\$1.30
11-0703	320	9" x 11"	\$1.11	\$1.17	\$1.30
11-0704	400	9" x 11"	\$1.11	\$1.17	\$1.30
11-0705	600	9" x 11"	\$1.11	\$1.17	\$1.30
11-0706	800	9" x 11"	\$1.91	\$2.03	\$2.25
11-0707	1000	9" x 11"	\$1.91	\$2.03	\$2.25
11-0708	1200	9" x 11"	\$1.91	\$2.03	\$2.25
11-0709	1500	9" x 11"	\$1.91	\$2.03	\$2.25
11-0710	2000	9" x 11"	\$1.91	\$2.03	\$2.25
11-0711	2500	9" x 11"	\$1.91	\$2.03	\$2.25



180	220	240	280	400
500	600	800	1000	1200

WATERPROOF EMERY PAPER

Powerful small particle adhesion provides superior surface finishing. Specially processed micro-grains provide additional cutting surface for fast material removal.

Order #	Grit	W x L	12+	6+	1+
11-3420	180	9" x 13¾"	\$0.76	\$0.86	\$0.95
11-3427	220	9" x 13¾"	\$0.76	\$0.86	\$0.95
11-3421	240	9" x 13¾"	\$0.76	\$0.86	\$0.95
11-3422	280	9" x 13¾"	\$0.76	\$0.86	\$0.95
11-3423	400	9" x 13¾"	\$0.76	\$0.86	\$0.95
11-3424	500	9" x 13¾"	\$0.76	\$0.86	\$0.95
11-3425	600	9" x 13¾"	\$0.76	\$0.86	\$0.95
11-3426	800	9" x 13¾"	\$0.76	\$0.86	\$0.95
11-3428	1000	9" x 13¾"	\$0.76	\$0.86	\$0.95
11-3429	1200	9" x 13¾"	\$0.76	\$0.86	\$0.95



SLURRY COATED POLISHING CLOTH

Cotton and Rayon material combination, the minerals are micron particles with a unique blend of various types of minerals applied in a slurry coating process. G-Tac slurry coated polishing cloths and strips provide strength and durability provided by a unique backing material which sets them apart from traditional polishing paper, while giving a constant uniform finish. *Colors may vary.

Order #	Grit	Color	W x L	12+	6+	1+
10-8340	360	Dark Gray	4" x 7½"	\$11.22	\$11.71	\$12.20
10-8340	400	Sky blue	4" x 7½"	\$11.22	\$11.71	\$12.20
10-8340	600	Coral blue	4" x 7½"	\$11.22	\$11.71	\$12.20
10-8340	800	Egg shell	4" x 7½"	\$11.22	\$11.71	\$12.20
10-8340	1000	Vibrant Pink	4" x 7½"	\$11.22	\$11.71	\$12.20
10-8340	1200	Dark Blue	4" x 7½"	\$11.22	\$11.71	\$12.20
10-8340	1500	Lavender	4" x 7½"	\$11.22	\$11.71	\$12.20
10-8340	2000	Blue	4" x 7½"	\$11.22	\$11.71	\$12.20
10-8340	4000	Light Blue	4" x 7½"	\$11.22	\$11.71	\$12.20
10-8342	Solid Assortment (10 sheets/box)			\$16.88	\$17.62	\$18.35



SLURRY COATED POLISHING STRIPS

Cotton and Rayon material combination, the minerals are micron particles with a unique blend of various types of minerals applied in a slurry coating process. G-Tac slurry coated polishing cloths and strips provide strength and durability provided by a unique backing material which sets them apart from traditional polishing paper, while giving a constant uniform finish.

Order #	Grit	Color	W x L	12+	6+	1+
10-8344	360	Black	4" x 7"	\$12.19	\$12.72	\$13.25
10-8344	400	Sky blue	4" x 7"	\$12.19	\$12.72	\$13.25
10-8344	600	Coral blue	4" x 7"	\$0.00	\$0.00	\$0.00
10-8344	800	Egg shell	4" x 7"	\$12.19	\$12.72	\$13.25
10-8344	1000	Vibrant Pink	4" x 7"	\$12.19	\$12.72	\$13.25
10-8344	1200	Dark Blue	4" x 7"	\$12.19	\$12.72	\$13.25
10-8344	1500	Lavender	4" x 7"	\$12.19	\$12.72	\$13.25
10-8344	2000	Blue	4" x 7"	\$12.19	\$12.72	\$13.25
10-8344	4000	Light Blue	4" x 7"	\$12.19	\$12.72	\$13.25
10-8343	Strip Assortment (120 perforated/box)			\$18.58	\$19.35	\$19.35

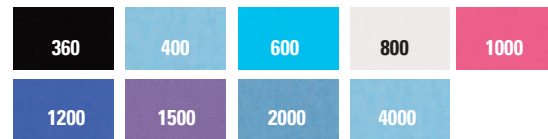

MICRO-POLINET SANDPAPER

- Micro-Polinet is a very flexible sanding cloth using ultra fine screen-mesh cloth (100 mesh), designed to prevent clogging.
- Both sides are coated with grains.
- Waterproof and oil resistant; can be used for both wet and dry operations.
- Constant sanding ability lasts till the end of its longer life.
- You can cut into any size to meet your purpose.
- Standard size: 210mm x 280mm

Order #	Grit	Color	Grain Diameter	12+	6+	1+
11-0758	600	Blue	20 μ	\$3.92	\$4.41	\$4.90
11-0758	800	Yellow	14 μ	\$3.68	\$4.14	\$4.60
11-0758	1000	Red	11.5 μ	\$3.92	\$4.41	\$4.90
11-0758	2000	Blue	6.7 μ	\$3.68	\$4.14	\$4.60
11-0758	3000	Orange	4 μ	\$3.68	\$4.14	\$4.60
11-0758	4000	Green	3 μ	\$3.68	\$4.14	\$4.60



Abrasives



EMERY CLOTH

Traditional cloth sheets provide consistent finish and extra long life. Can be used with split wood mandrel 11-3060 or split mandrels for handpieces 11-3008 and 11-3009.

Order #	Grit	Grade	W x L	12+	6+	1+
11-0730	180	Coarse	9" x 11"	\$1.19	\$1.26	\$1.40
11-0731	220-240	Medium	9" x 11"	\$1.19	\$1.26	\$1.40
11-0732	280	Fine	9" x 11"	\$1.19	\$1.26	\$1.40



WET OR DRY POLISHING PAPER

The non-woven backing allows easy polishing of interior shapes and contours. Precision, micron grading provides a unique, consistent finish. Can be used with split wood mandrel 11-3060 or split mandrels for handpieces 11-3008 and 11-3009. Kit contains six sheets, one grit each.

Order #	Grit	Micron	Color	W x L	12+	6+	1+
11-0720	400	30 μ	Green	8" x 10"	\$1.66	\$1.73	\$1.80
11-0721	600	15 μ	Gray	8" x 10"	\$1.66	\$1.73	\$1.80
11-0722	1200	9 μ	Blue	8" x 10"	\$1.66	\$1.73	\$1.80
11-0723	4000	3 μ	Pink	8" x 10"	\$1.66	\$1.73	\$1.80
11-0724	6000	2 μ	Mint Green	8" x 10"	\$1.66	\$1.73	\$1.80
11-0725	8000	1 μ	Pale Green	8" x 10"	\$1.66	\$1.73	\$1.80
11-0726	Kit (6 sheets) 1 each				\$5.20	\$5.42	\$5.65



PLATINUM ABRASIVE PAPER

Used exclusively for platinum, this abrasive paper is an excellent pre-polish step when working with this precious metal.

Order #	Grit	Micron	Color	W x L	12+	6+	1+
11-0745	360	35 μ	Gray	9" x 11"	\$1.06	\$1.10	\$1.15
11-0746	400	30 μ	Gray	9" x 11"	\$1.06	\$1.10	\$1.15
11-0747	500	20 μ	Gray	9" x 11"	\$1.06	\$1.10	\$1.15



MICRO-FINISHING FILM SHEETS

Use on large surface areas. These special film sheets are micro-graded abrasive, which provides a consistent cut rate and finish. Micro-graded film sheets reduce sanding steps and provide an easy-to-buff finish. Long lasting, these micro-grade films can replace emery papers.

Order #	Grit	Micron	W x L	12+	6+	1+
11-0736	220	60 μ	8½" x 11"	\$2.02	\$2.11	\$2.20
11-0737	320	40 μ	8½" x 11"	\$2.02	\$2.11	\$2.20
11-0739	500	20 μ	8½" x 11"	\$2.02	\$2.11	\$2.20
11-0740	600	15 μ	8½" x 11"	\$2.02	\$2.11	\$2.20
11-0741	1200	9 μ	8½" x 11"	\$2.02	\$2.11	\$2.20

LAPPING FILM

Finishing films designed by to reduce the buffing process for platinum and gold. Available in three grits for a three-step finishing process for platinum and a one-step process for gold finishing. The 12 micron (yellow) sheet is used for pre-polish, the five micron (brown) is used to impart a bright finish on platinum, and the three micron (pink) sheet is used to produce an extra bright finish on platinum before the final buffing. Use with a 11-3060 split wood mandrel or split mandrels for handpiece 11-3008 and 11-3009.



Order #	Micron	Color	W x L	12+	6+	1+
11-0750	12 μ	Yellow	8½" x 11"	\$1.52	\$1.58	\$1.65
11-0751	5 μ	Brown	8½" x 11"	\$1.52	\$1.58	\$1.65
11-0752	3 μ	Pink	8½" x 11"	\$1.52	\$1.58	\$1.65

DIAMOND LAPPING FILM 668X

Use on extremely hard materials for a repeatable, precision finish. Combines micron-graded diamond particles, resin bonding, and highly uniformed polyester film (self-adhesive) backing for a consistent, cleaner alternative to diamond compounds or slurries.



Item	Order #	Micron	OD	12+	6+	1+
A	11-0753	0.05 μ	6"	\$13.62	\$14.21	\$14.80
B	11-0754	3 μ	6"	\$13.89	\$14.50	\$15.10
C	11-0755	6 μ	6"	\$13.89	\$14.50	\$15.10
D	11-0756	9 μ	6"	\$13.89	\$14.50	\$15.10
E	11-0757	15 μ	6"	\$13.89	\$14.50	\$15.10



MICRO-FINISHING DISC

Superior graded aluminum oxide pressure sensitive discs that ensure consistent surface finish. Must be used with a 6" aluminum back plate.

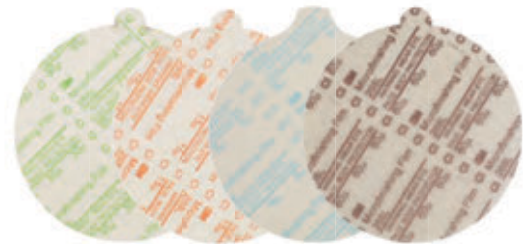

Item	Order #	Micron	OD	12+	6+	1+
F	11-0800	30 μ	6"	\$1.86	\$2.12	\$2.65
G	11-0800	15 μ	6"	\$1.86	\$2.12	\$2.65
H	11-0800	9 μ	6"	\$1.86	\$2.12	\$2.65
J	11-0800	60 μ	6"	\$1.86	\$2.12	\$2.65



F G H J

SANDING SPONGES

These sanding sponges provide flexibility and will conform to almost any surface and contour. The sponges are coated with a unique slurry that provides a quick, smooth cut in medium and a pre-polish finish in micro-fine. These unique pads can be folded or trimmed to fit in most details and will not gouge surfaces.



Order #	Grade	W x L	12+	6+	1+
11-8042	Extra Fine	4½" x 5½"	\$3.96	\$4.13	\$4.30
11-8041	Ultra-Fine	4½" x 5½"	\$3.96	\$4.13	\$4.30
11-8043	Fine	4½" x 5½"	\$3.96	\$4.13	\$4.30
11-8040	Micro Fine	4½" x 5½"	\$3.96	\$4.13	\$4.30
11-8044	Medium	4½" x 5½"	\$3.96	\$4.13	\$4.30
11-8045	Assortment (set of 5: one of each grade)		\$20.65	\$21.55	\$22.45



Abrasives

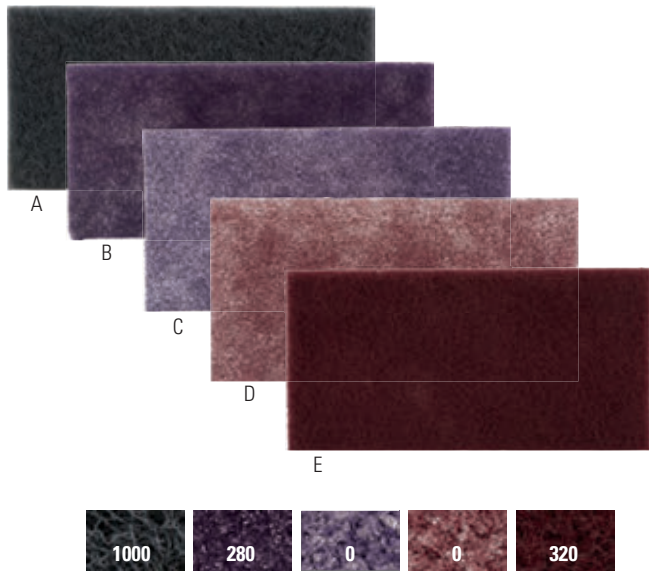

PRIMO® NON-WOVEN ABRASIVE PADS

Quality non-hand woven abrasive pad ideal for cleaning, deburring, and creating satin finishes

Item	Order #	Grit	Color	W x L	12+	6+	1+
A	10-8320	1000	Gray	6" x 9"	\$1.56	\$1.63	\$1.70
B	10-8320	280	Purple	6" x 9"	\$1.56	\$1.63	\$1.70
C	10-8320	0	Light Purple	6" x 9"	\$1.56	\$1.63	\$1.70
D	10-8320	0	Light Maroon	6" x 9"	\$1.56	\$1.63	\$1.70
E	10-8320	320	Maroon	6" x 9"	\$1.56	\$1.63	\$1.70



MOUNTED MIDGET BUFFS

Mounted on a 3/32" shank.

Order #	Grade	OD	Thickness	12+	6+	1+
11-8281	Coarse	7/8"	1/4"	\$1.27	\$1.35	\$1.50
11-8280	Medium	7/8"	1/4"	\$1.27	\$1.35	\$1.50
11-8279	Fine	7/8"	1/4"	\$1.27	\$1.35	\$1.50
11-8278	Luster Bright	7/8"	1/4"	\$1.27	\$1.35	\$1.50

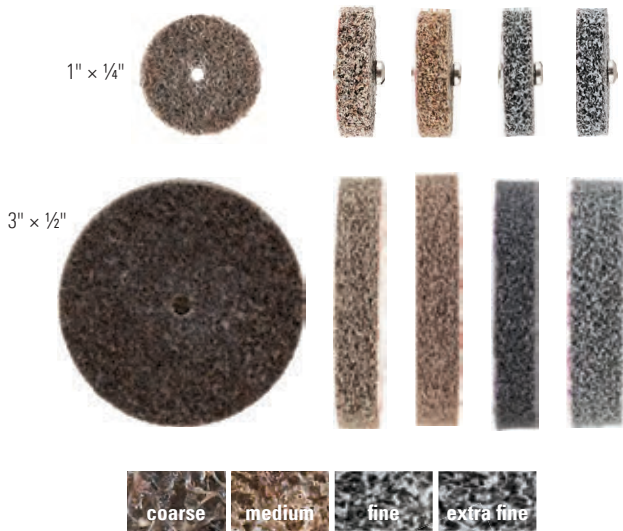

UNITIZED WHEELS

Unitized wheels provide a faster cut rate and longer life. Made from a unique construction, they resist loading while providing a smooth-running, chatter-free feeling. Non-woven technology also allows these wheels to run cool and discourages undercutting and gouging. Unitized wheels are long wearing and have a unique, spring-like action.

Order #	Grade	OD	Width	Hole ID	12+	6+	1+
10-8176	Coarse	1"	1/4"	1/4"	\$2.25	\$2.35	\$2.45
10-8175	Medium	1"	1/4"	1/4"	\$2.25	\$2.35	\$2.45
10-8174	Fine	1"	1/4"	1/4"	\$2.07	\$2.16	\$2.25
10-8173	Extra Fine	1"	1/4"	1/4"	\$2.07	\$2.16	\$2.25
10-8168	Coarse	3"	1/2"	1/2"	\$12.51	\$13.06	\$13.60
10-8167	Medium	3"	1/2"	1/2"	\$12.51	\$13.06	\$13.60
10-8166	Fine	3"	1/2"	1/2"	\$11.73	\$12.24	\$12.75
10-8165	Extra Fine	3"	1/2"	1/2"	\$11.73	\$12.24	\$12.75
43-1283	1/8" Mandrel (1/8" shank with one silver cap for 1/8" and 1/4" thick wheels)				\$1.44	\$1.62	\$1.80





A



B



C



D



BRISTLE DISCS

Kit contains 12 each of the following 3/16" discs: 120, 220, 400, pumice, polish I, and polish II grits. Along with two mandrels, 43-1281.



Item	Order #	Description	12+	6+	1+
A	10-9115	74-Piece, 3/16"	\$57.64	\$60.14	\$62.65

Contains 8 each of all sizes and grits along with 4 mandrels, 43-1281. Discs are molded abrasive-filled bristle discs used for deburring, blending, finishing, and polishing.

Item	Order #	Description	12+	6+	1+
B	10-9117	116-Piece Assorted Grits and Sizes	\$78.11	\$81.50	\$84.90

Kit contains 12 each of the following 1" discs: 36, 50, 80, and 120 grits. Along with two mandrels, 43-1281.

Item	Order #	Description	12+	6+	1+
C	10-9116	50-Piece, 1"	\$40.99	\$42.77	\$44.55

Kit contains 10 each of the following 3/4" discs: 80, 220, 400, and pumice grits. Along with two mandrels, 43-1282.

Item	Order #	Description	12+	6+	1+
D	10-9104	42-Piece Kit, 3/4"	\$36.06	\$37.63	\$39.20

MICRO FIBER DISC

These new micro-fiber, reinforced separating discs are superior in their cutting ability and are more economical due to their durability. Unlike most ultra-thin separating discs, these do not break easily even when bent. The quality and performance are unmatched by most cutting products.

Order #	Material	OD	Thickness	Per Pack	12+	6+	1+
11-8206	Silicone-Carbide	7/8"	.01mm	Pack of 10	\$12.12	\$13.14	\$14.60
11-8206	Silicone-Carbide	7/8"	.01mm	Pack of 100	\$94.65	\$100.22	\$111.35
11-8207	Aluminum-Oxide	7/8"	.01mm	Pack of 10	\$12.12	\$13.14	\$14.60
11-8207	Aluminum-Oxide	7/8"	.01mm	Pack of 100	\$94.65	\$100.22	\$111.35



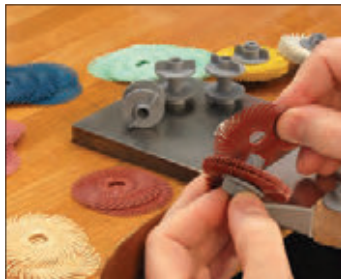
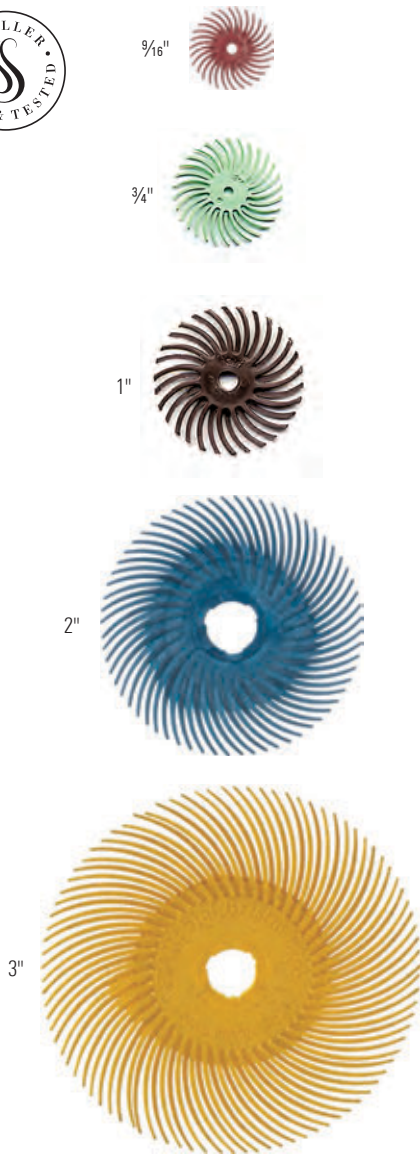

RADIAL BRISTLE DISCS

The small radial bristle discs have a flexible bristle design that can be used for cleaning, pre-polishing, semi-finishing, blending, and texturing. Excellent for gold, silver, copper, pewter, and brass applications. Removes the oxidation from jewelry without messy compounds. Great for cleaning and maintaining tiny, hard-to-reach areas and fine detail. Recommended speed for most applications: 15,000 RPMs, Maximum (MOS) 30,000 RPM. Applications/Recommendations:

- Fire-scale removal: Yellow (80X) 15,000 to 20,000 RPMs.
- Light oxide removal: Red or Blue (220X/400X) 10,000 to 15,000 RPMs.
- Heavy cleaning: Yellow (80X) 10,000 to 15,000 RPMs.
- Light cleaning: Red or Blue (220X/400X) 10,000 to 15,000 RPMs.
- Pre-Polishing: Blue or Light Gray (400X/Pumice) 12,000 to 18,000 RPMs.
- Semi-Finishing: Blue or Light Gray (400X/Pumice) 5,000 to 10,000 RPMs.
- Blending: Red or Blue (220X/400X) 8,000 to 15,000 RPMs.
- Texturing: Yellow or Red (80X/220X) 5,000 to 8,000 RPMs.

Order #	Material	Grit	Micron	OD	Color	12+	6+	1+
10-9100	Plastic	80	—	3/4"	Yellow	\$1.20	\$1.25	\$1.30
10-9101	Plastic	220	—	3/4"	Red	\$1.20	\$1.25	\$1.30
10-9102	Plastic	400	—	3/4"	Blue	\$1.20	\$1.25	\$1.30
10-9103	Pumice	—	—	3/4"	Pink	\$1.20	\$1.25	\$1.30
10-9098	Plastic	—	1 μ	3/4"	Light Green	\$1.20	\$1.25	\$1.30
10-9099	Plastic	—	6 μ	3/4"	Peach	\$1.20	\$1.25	\$1.30
10-9105	Plastic	120	—	1/16"	White	\$1.32	\$1.40	\$1.55
10-9106	Plastic	220	—	1/16"	Red	\$1.32	\$1.40	\$1.55
10-9107	Plastic	400	—	1/16"	Blue	\$1.32	\$1.40	\$1.55
10-9108	Pumice	—	—	1/16"	Pink	\$1.27	\$1.35	\$1.50
10-9109	Plastic	—	1 μ	1/16"	Light Green	\$1.32	\$1.40	\$1.55
10-9110	Plastic	—	6 μ	1/16"	Peach	\$1.27	\$1.35	\$1.50
10-9111	Plastic	36	—	1"	Brown	\$1.27	\$1.35	\$1.50
10-9112	Plastic	50	—	1"	Light Green	\$1.32	\$1.40	\$1.55
10-9113	Plastic	80	—	1"	Yellow	\$1.32	\$1.40	\$1.55
10-9114	Plastic	120	—	1"	White	\$1.32	\$1.40	\$1.55
10-9130	Plastic	80	—	2"	Yellow	\$2.16	\$2.26	\$2.35
10-9131	Plastic	120	—	2"	White	\$2.16	\$2.26	\$2.35
10-9132	Plastic	220	—	2"	Red	\$2.16	\$2.26	\$2.35
10-9133	Plastic	400	—	2"	Blue	\$2.16	\$2.26	\$2.35
10-9134	Pumice	—	—	2"	Pink	\$2.16	\$2.26	\$2.35
10-9135	Plastic	—	1 μ	2"	Light Green	\$2.07	\$2.16	\$2.25
10-9136	Plastic	—	6 μ	2"	Peach	\$2.16	\$2.26	\$2.35
10-9140	Plastic	80	—	3"	Yellow	\$3.04	\$3.17	\$3.30
10-9141	Plastic	120	—	3"	White	\$2.94	\$3.07	\$3.20
10-9142	Plastic	220	—	3"	Red	\$3.04	\$3.17	\$3.30
10-9143	Plastic	400	—	3"	Blue	\$3.04	\$3.17	\$3.30
10-9144	Pumice	—	—	3"	Pink	\$3.04	\$3.17	\$3.30
10-9145	Plastic	—	1 μ	3"	Light Green	\$3.04	\$3.17	\$3.30
10-9146	Plastic	—	6 μ	3"	Peach	\$3.04	\$3.17	\$3.30

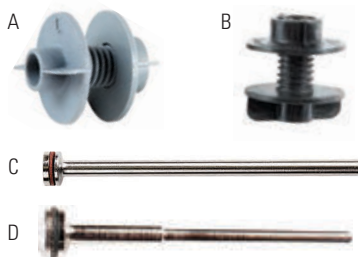

TAPERED WHEEL ADAPTER

Item	Order #	Description	Color	ID	12+	6+	1+
A	10-9163	Left Adapter	Gray	3/8"	\$2.17	\$2.30	\$2.55
B	10-9162	Right Adapter	Black	3/8"	\$2.17	\$2.30	\$2.55
C	43-1302	Mandrel		3/32"	\$1.41	\$1.53	\$1.70
D	43-1282	Heavy Duty Mandrel		1/8"	\$1.47	\$1.68	\$2.10

HIGH-QUALITY CUT-OFF DISCS

Silicon carbide non-contaminating, extra durable. Extra thin cutting for gold. Use reinforced mandrel 43-1282.

Order #	OD	Thickness	Per Pack	12+	6+	1+
11-8190	7/8"	0.009"	Box of 25	\$8.92	\$9.31	\$9.70
11-8192	7/8"	0.009"	Box of 100	\$31.60	\$32.98	\$34.35
11-8194	7/8"	0.006"	Box of 25	\$8.92	\$9.31	\$9.70
11-8196	7/8"	0.006"	Box of 100	\$31.60	\$32.98	\$34.35



Side

ALUMINUM-OXIDE CUT-OFF WHEELS

Wheels for cutting and finishing cobalt and hard metals. Fast, cool, and odor-free.



Item	Order #	Color	OD	Thickness	12+	6+	1+
A	11-8240	Light Brown	1 1/4"	1/4"	\$27.71	\$29.34	\$32.60
B	11-8242	Brown	1 1/4"	3/8"	\$27.71	\$29.34	\$32.60
C	11-8244	Red	1 1/2"	1/4"	\$27.71	\$29.34	\$32.60
D	11-8246	Ruby	1 1/2"	3/8"	\$31.05	\$32.40	\$33.75

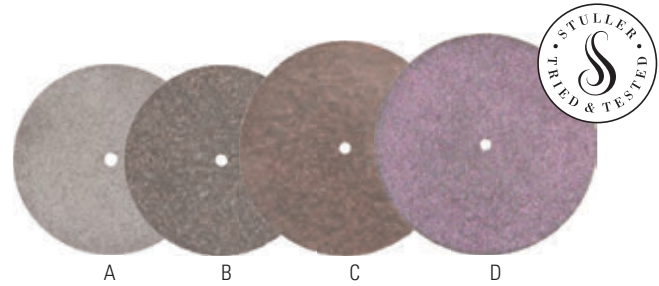

A B C D

SEPARATING DISCS

High-speed, resin-bonded, aluminum-oxide and silicone-carbide separating discs. Fast-cutting, precise, and long-lasting.



Order #	Material	OD	Thickness	12+	6+	1+
11-8197	Aluminum-Oxide	7/8"	1/8"	\$40.34	\$42.10	\$43.85
11-8198	Aluminum-Oxide	7/8"	1/4"	\$10.35	\$10.80	\$11.25
11-8204	Silicone-Carbide	7/8"	1/8"	\$40.34	\$42.10	\$43.85
11-8205	Silicone-Carbide	7/8"	1/4"	\$11.36	\$11.86	\$12.35
11-8206	Silicone-Carbide	7/8"	.01mm	\$94.65	\$100.22	\$111.35
11-8206	Silicone-Carbide	7/8"	.01mm	\$12.12	\$13.14	\$14.60



Side

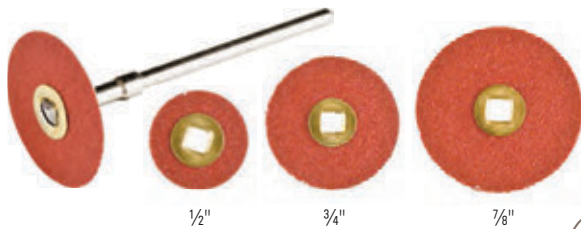

1/2" 3/4" 7/8"



ADALOX® SNAP-ON DISCS: ALUMINUM-OXIDE

Aluminum-oxide discs are a reddish-brown color. Thin, resin bonded flexible paper. Aluminum-oxide is less aggressive than emery. Use with snap-on mandrel 10-7050.



Order #	Grade	OD	12+	6+	1+
10-7000	Coarse	1/2"	\$4.14	\$4.32	\$4.50
10-7001	Medium	1/2"	\$4.14	\$4.32	\$4.50
10-7002	Fine	1/2"	\$4.14	\$4.32	\$4.50
10-7005	Coarse	3/4"	\$4.19	\$4.37	\$4.55
10-7006	Medium	3/4"	\$4.19	\$4.37	\$4.55
10-7007	Fine	3/4"	\$4.19	\$4.37	\$4.55
10-7010	Coarse	7/8"	\$4.19	\$4.37	\$4.55
10-7011	Medium	7/8"	\$4.19	\$4.37	\$4.55
10-7012	Fine	7/8"	\$4.19	\$4.37	\$4.55

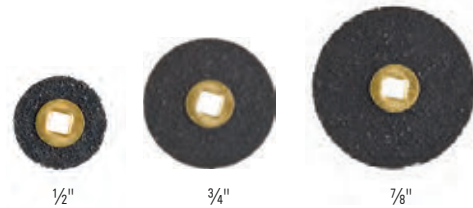

1/2" 3/4" 7/8"



SILICONE-CARBIDE DISCS

Silicon carbide discs are a black color. Thin, resin bonded flexible paper. Silicone-carbide is less aggressive than emery. Use with snap-on mandrel 10-7050.



Order #	Grade	OD	12+	6+	1+
10-7015	Coarse	1/2"	\$4.14	\$4.32	\$4.50
10-7016	Medium	1/2"	\$4.14	\$4.32	\$4.50
10-7017	Fine	1/2"	\$4.14	\$4.32	\$4.50
10-7020	Coarse	3/4"	\$4.14	\$4.32	\$4.50
10-7021	Medium	3/4"	\$4.14	\$4.32	\$4.50
10-7025	Coarse	7/8"	\$4.14	\$4.32	\$4.50
10-7026	Medium	7/8"	\$4.19	\$4.37	\$4.55
10-7027	Fine	7/8"	\$4.14	\$4.32	\$4.50
10-7022	Fine	3/4"	\$4.14	\$4.32	\$4.50

Abrasives

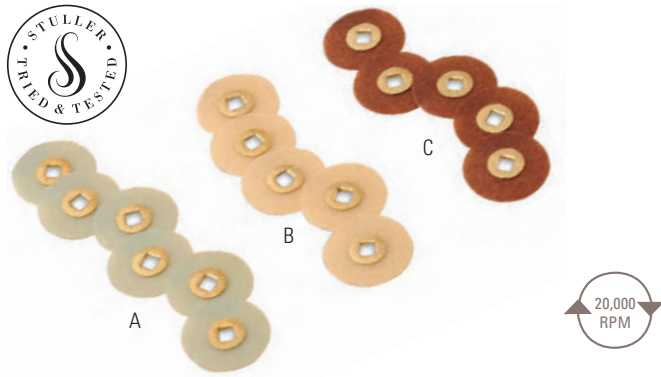

MAGNUM SANDING SNAP-ON DISCS

The aluminum-oxide discs work similarly to the Moor plastic and Adalox® discs. They are designed with a special reinforced, waterproof backing. This disc is recommended for fast cutting of acrylics and is excellent for polishing non-precious alloys. Use with snap-on mandrel 10-7050.



Item	Order #	Grade	Color	OD	12+	6+	1+
A	10-7122	Coarse	Reddish Brown	7/8"	\$11.50	\$12.00	\$12.50
B	10-7121	Medium	White	7/8"	\$11.50	\$12.00	\$12.50
C	10-7120	Fine	Green	7/8"	\$11.50	\$12.00	\$12.50

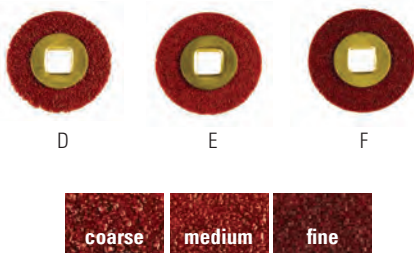

ALUMINUM-OXIDE SANDING DISCS

Aluminum-oxide grit provides excellent results in sanding and smoothing operations. The flexible backing allows access to hard-to-reach areas. Use with snap-on mandrel 10-7050.



Item	Order #	Grade	Color	OD	12+	6+	1+
D	10-1077	Coarse	Brown	1/2"	\$12.92	\$13.68	\$15.20
E	10-1078	Medium	Brown	1/2"	\$12.92	\$13.68	\$15.20
F	10-1079	Fine	Brown	1/2"	\$12.92	\$13.68	\$15.20
	10-7050	Snap-On Mandrel (3/32" shank)			\$1.70	\$1.85	\$2.05

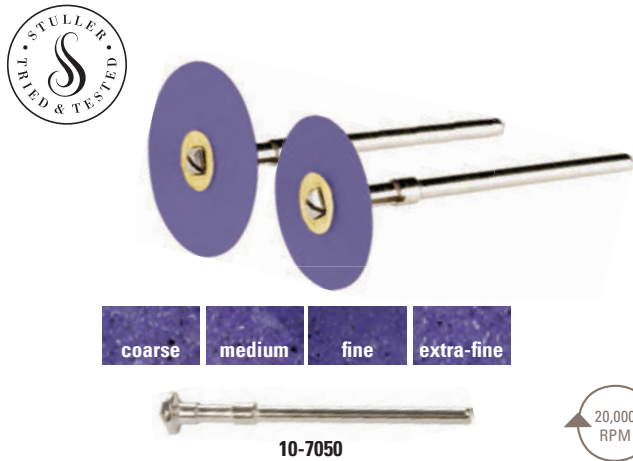

ALUMINUM-OXIDE SANDING DISCS

Nickel-plated small wheel mandrels.



Order #	Grade	OD	12+	6+	1+	
10-7100	Coarse	7/8"	\$5.87	\$6.21	\$6.90	
10-7101	Medium	7/8"	\$5.87	\$6.21	\$6.90	
10-7102	Fine	7/8"	\$5.87	\$6.21	\$6.90	
10-7103	Extra Fine	7/8"	\$5.87	\$6.21	\$6.90	
10-7104	Coarse	3/4"	\$5.87	\$6.21	\$6.90	
10-7105	Medium	3/4"	\$5.87	\$6.21	\$6.90	
10-7106	Fine	3/4"	\$5.87	\$6.21	\$6.90	
10-7107	Extra Fine	3/4"	\$5.87	\$6.21	\$6.90	
10-7050	Snap-On Mandrel (3/32" shank)			\$1.70	\$1.85	\$2.05



Contains: 25 Coarse, 50 Medium, 25 Fine, and Snap-on Mandrels.

YELLOW SANDING DISCS

Yellow abrasive disc with snap-on feature used in the pre-finishing process. Exclusive aluminum-oxide grit provides excellent results in sanding and smoothing operations. Hard-to-reach places are accessible with the flexible backing.



Order #	Grade	OD	12+	6+	1+	
10-7125	103-Piece Sanding Disc Kit			\$12.45	\$13.19	\$14.65
10-7030	Coarse	3/4"	\$8.42	\$8.78	\$9.15	
10-7031	Medium	3/4"	\$8.42	\$8.78	\$9.15	
10-7032	Fine	3/4"	\$8.33	\$8.69	\$9.05	
10-7033	Coarse	7/8"	\$8.33	\$8.69	\$9.05	
10-7034	Medium	7/8"	\$8.33	\$8.69	\$9.05	
10-7035	Fine	7/8"	\$8.33	\$8.69	\$9.05	
10-7050	Snap-On Mandrel (3/32" shank)			\$1.70	\$1.85	\$2.05

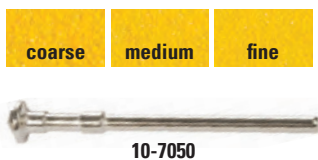

ZIRCONIA PIN HOLE SANDING DISCS

Zirconia sanding discs are superior to other conventional abrasives. Aggressively cuts and grinds metals with uniform file-like finish. Ideal for platinum use. Prolong life by using water as a lubricant. Mandrels sold separately.



Order #	Grade	OD	12+	6+	1+
10-7036	Coarse	3/4"	\$8.18	\$8.87	\$9.85
10-7037	Medium	3/4"	\$8.18	\$8.87	\$9.85
10-7038	Fine	3/4"	\$8.18	\$8.87	\$9.85
10-7039	Coarse	7/8"	\$8.18	\$8.87	\$9.85
10-7040	Medium	7/8"	\$8.18	\$8.87	\$9.85
10-7041	Fine	7/8"	\$8.18	\$8.87	\$9.85
43-1280	Reinforced Screw Mandrel (3/32")		\$0.89	\$0.95	\$1.05



SNAP-ON SANDING DISCS

Mandrels sold separately.



Order #	Grade	OD	12+	6+	1+
10-7044	Coarse	7/8"	\$8.26	\$8.96	\$9.95
10-7043	Medium	7/8"	\$8.26	\$8.96	\$9.95
10-7042	Fine	7/8"	\$8.26	\$8.96	\$9.95
10-7050	Snap-On Mandrel (3/32" shank)		\$1.70	\$1.85	\$2.05

MOORE'S MAGNUM POLISHERS

Moore's Magnum Polishers feature unique "felt-like" surfaces specially designed for working with all polishing parts.



Order #	Grade	OD	12+	6+	1+
10-7108	Fine	7/8"	\$24.70	\$25.78	\$26.85
10-7140	Fine	7/8"	\$24.70	\$25.78	\$26.85
10-7120	Fine	7/8"	\$11.50	\$12.00	\$12.50



PINK ALUMINUM-OXIDE POINTS

Long-lasting pink aluminum-oxide points are ideal for fine finishing of non-precious and semi-precious metals. Non-contaminating.



Item	Order #	Shape	12+	6+	1+
A	11-5100	Point	\$21.17	\$22.41	\$24.90
B	11-5102	Cylinder	\$21.17	\$22.41	\$24.90
C	11-5103	Cone	\$21.17	\$22.41	\$24.90
D	11-5104	Inverted Cone	\$21.17	\$22.41	\$24.90
E	11-5105	Wheel	\$21.17	\$22.41	\$24.90



KONTOUR-DIAMOND IMPREGNATED STONES

Diamond-impregnated stones give off very little heat and will cut time when working with harder metals. Medium grit stones used for shaping and contouring. Mounted on 3/32" shanks.

Item	Order #	Shape	OD	Thickness	12+	6+	1+
F	28-6001	Square	5/8"	1/8"	\$39.84	\$41.57	\$43.30
G	28-6006	Square	7/8"	1/8"	\$39.84	\$41.57	\$43.30
H	28-6005	Knife-Edge	7/8"	1/8"	\$39.84	\$41.57	\$43.30





Contains 4 square-edge, 4 knife-edge, 1 cylinder of each grit and size with mandrels.

UNMOUNTED SILICONE POLISHING WHEELS

Premium unmounted, silicone polishing wheels. Silicone rubber for flexibility and smooth finishing. Each wheel is impregnated with carefully graded silicone-carbide abrasive. These wheels provide a superior finish without messy compounds at a great price. Unmounted wheels have a 1/16" arbor hole. Imported from Germany. Use mandrels: 43-1288 or 43-1289

Order #	Description	12+	6+	1+
11-6052	117-Piece Kit Assortment	\$45.05	\$47.70	\$53.00

STEP 1

White
100 Grit
Coarse



Order #	11-6000	11-6001	11-6002	11-6003	11-6004	11-6005	11-6006	11-6007	11-6008	11-6009
OD	7/8"	7/8"	5/8"	7/8"	7/8"	5/8"	5/16"	3/8"	1/2"	9/16"
Thickness	1/8"	1/4"	1/8"	1/16"	1/8"	1/8"	13/16"	7/8"	7/8"	1"
Shape	Square	Square	Square	Square	Knife-Edge	Knife-Edge	Cylinder	Cylinder	Cylinder	Cylinder
12+	\$0.58	\$0.87	\$0.58	\$0.58	\$0.58	\$0.58	\$0.58	\$0.71	\$0.87	\$1.37
6+	\$0.63	\$0.95	\$0.63	\$0.63	\$0.63	\$0.63	\$0.63	\$0.77	\$0.95	\$1.49
1+	\$0.70	\$1.05	\$0.70	\$0.70	\$0.70	\$0.70	\$0.70	\$0.85	\$1.05	\$1.65

STEP 2

Black
220 Grit
Medium



Order #	11-6012	11-6013	11-6014	11-6015	11-6016	11-6017	11-6018	11-6019	11-6020	11-6021
OD	7/8"	7/8"	5/8"	7/8"	7/8"	5/8"	5/16"	3/8"	1/2"	9/16"
Thickness	1/8"	1/4"	1/8"	1/16"	1/8"	1/8"	13/16"	7/8"	7/8"	1"
Shape	Square	Square	Square	Square	Knife-Edge	Knife-Edge	Cylinder	Cylinder	Cylinder	Cylinder
12+	\$0.58	\$0.87	\$0.58	\$0.58	\$0.58	\$0.58	\$0.58	\$0.71	\$0.87	\$1.37
6+	\$0.63	\$0.95	\$0.63	\$0.63	\$0.63	\$0.63	\$0.63	\$0.77	\$0.95	\$1.49
1+	\$0.70	\$1.05	\$0.70	\$0.70	\$0.70	\$0.70	\$0.70	\$0.85	\$1.05	\$1.65

STEP 3

Blue
800 Grit
Fine



Order #	11-6025	11-6026	11-6027	11-6028	11-6029	11-6030	11-6031	11-6032	11-6033	11-6034
OD	7/8"	7/8"	5/8"	7/8"	7/8"	5/8"	5/16"	3/8"	1/2"	9/16"
Thickness	1/8"	1/4"	1/8"	1/16"	1/8"	1/8"	13/16"	7/8"	7/8"	1"
Shape	Square	Square	Square	Square	Knife-Edge	Knife-Edge	Cylinder	Cylinder	Cylinder	Cylinder
12+	\$0.64	\$0.97	\$0.64	\$0.64	\$0.64	\$0.64	\$0.64	\$0.78	\$0.97	\$1.52
6+	\$0.67	\$1.01	\$0.67	\$0.67	\$0.67	\$0.67	\$0.67	\$0.82	\$1.01	\$1.58
1+	\$0.70	\$1.05	\$0.70	\$0.70	\$0.70	\$0.70	\$0.70	\$0.85	\$1.05	\$1.65

STEP 4

Pink
1200 Grit
Extra Fine



Order #	11-6040	11-6041	11-6042	11-6043	11-6044	11-6045	11-6046	11-6047	11-6048	11-6049
OD	7/8"	7/8"	5/8"	7/8"	7/8"	5/8"	5/16"	3/8"	1/2"	9/16"
Thickness	1/8"	1/4"	1/8"	1/16"	1/8"	1/8"	13/16"	7/8"	7/8"	1"
Shape	Square	Square	Square	Square	Knife-Edge	Knife-Edge	Cylinder	Cylinder	Cylinder	Cylinder
12+	\$0.58	\$0.87	\$0.58	\$0.58	\$0.58	\$0.58	\$0.58	\$0.71	\$0.87	\$1.37
6+	\$0.63	\$0.95	\$0.63	\$0.63	\$0.63	\$0.63	\$0.63	\$0.77	\$0.95	\$1.49
1+	\$0.70	\$1.05	\$0.70	\$0.70	\$0.70	\$0.70	\$0.70	\$0.85	\$1.05	\$1.65



MOUNTED SILICONE POLISHING WHEELS

Premium, ready-to-use, mounted silicone polishers. Get a superior finish without the messy compounds. Excellent for karat golds, platinum, and palladium. 3/32" shanks.



Order #	Description	12+	6+	1+
11-6120	32-Piece Kit: 2 of each	\$25.80	\$27.32	\$30.35



STEP 1

Aggressive
Pre-Finish
White / 100 Grit
Coarse



Order #	11-6100	11-6101	11-6102	11-6103
OD	1/4"	1/4"	7/16"	7/16"
Thickness	3/8"	1 1/16"	1/8"	1/8"
Shape	Point	Bullet	Square	Knife-Edge
12+	\$0.92	\$0.92	\$0.92	\$0.92
6+	\$1.03	\$1.03	\$1.03	\$1.03
1+	\$1.15	\$1.15	\$1.15	\$1.15

STEP 2

Pre-Finish
Black / 220 Grit
Medium



Order #	11-6105	11-6106	11-6107	11-6108
OD	1/4"	1/4"	7/16"	7/16"
Thickness	3/8"	1 1/16"	1/8"	1/8"
Shape	Point	Bullet	Square	Knife-Edge
12+	\$0.92	\$0.92	\$0.92	\$0.92
6+	\$1.03	\$1.03	\$1.03	\$1.03
1+	\$1.15	\$1.15	\$1.15	\$1.15

STEP 3

Finish
Blue / 800 Grit
Fine



Order #	11-6110	11-6111	11-6112	11-6113
OD	1/4"	1/4"	7/16"	7/16"
Thickness	3/8"	1 1/16"	1/8"	1/8"
Shape	Point	Bullet	Square	Knife-Edge
12+	\$0.92	\$0.92	\$0.92	\$0.92
6+	\$1.03	\$1.03	\$1.03	\$1.03
1+	\$1.15	\$1.15	\$1.15	\$1.15

STEP 4

High Polish
Pink / 1200 Grit
Extra Fine



Order #	11-6115	11-6116	11-6117	11-6118
OD	1/4"	1/4"	7/16"	7/16"
Thickness	3/8"	1 1/16"	1/8"	1/8"
Shape	Point	Bullet	Square	Knife-Edge
12+	\$0.92	\$0.92	\$0.92	\$0.92
6+	\$1.03	\$1.03	\$1.03	\$1.03
1+	\$1.15	\$1.15	\$1.15	\$1.15



GOLD POLISHING KIT

An introductory kit with a generous amount of our standard sized silicone pre-polished, high shine, and long life wheels along with mini-point cylinders and mandrels.



Order #	Description	12+	6+	1+
11-8100	44-Piece Gold Kit	\$40.80	\$42.58	\$44.35



PLATINUM/GOLD POLISHING KIT

The most complete kit available! A wide range of silicone pre-polish and high shine wheels. Cutting discs for gold in two sizes. Mini-points, mandrels, and cylinders for inside rings. Silipum wheels that won't scratch the stones. Wheels come in square-edge, knife-edge, 7/8", and 9/8". This kit will handle all your polishing needs.



Order #	Description	12+	6+	1+
11-8110	70-Piece Platinum/Gold Polishing Kit	\$47.52	\$49.58	\$51.65

Abrasives

STULLER PREMIUM SILICONE POLISHERS

The ultimate silicone-carbide polishers for gold and all precious metal alloys in an easy three-step process. Made in Switzerland.

GREEN Finish



Order #	11-6324	11-6325	11-6326	11-6327
OD	1/8"	7/32"	7/8"	7/8"
Thickness	7/8"	5/8"	1/8"	1/8"
Shape	Cylinder	Point	Knife-Edge	Square
12+	\$0.69	\$1.06	\$0.69	\$0.69
6+	\$0.72	\$1.10	\$0.72	\$0.72
1+	\$0.75	\$1.15	\$0.75	\$0.75

YELLOW Pre-Polish



Order #	11-6328	11-6329	11-6330	11-6331
OD	1/8"	7/32"	7/8"	7/8"
Thickness	7/8"	5/8"	1/8"	1/8"
Shape	Cylinder	Point	Knife-Edge	Square
12+	\$0.69	\$1.06	\$0.69	\$0.69
6+	\$0.72	\$1.10	\$0.72	\$0.72
1+	\$0.75	\$1.15	\$0.75	\$0.75

PINK High Gloss



Order #	11-6333	11-6334	11-6335	11-6336
OD	1/8"	7/32"	7/8"	7/8"
Thickness	7/8"	5/8"	1/8"	1/8"
Shape	Cylinder	Point	Knife-Edge	Square
12+	\$0.69	\$1.06	\$0.69	\$0.69
6+	\$0.72	\$1.10	\$0.72	\$0.72
1+	\$0.75	\$1.15	\$0.75	\$0.75

SILICONE PRE-POLISH WHEELS

A coarse wheel for fast cutting and leaving a very smooth surface. Slightly harder and longer lasting than the flexible gray.



BLUE 120 Grit Firm



Order #	11-8114	11-8116	11-8118
OD	7/8"	7/8"	1/4"
Thickness	1/8"	1/8"	7/8"
Shape	Square	Knife-Edge	Cylinder
12+	\$5.47	\$5.47	\$5.47
6+	\$5.71	\$5.71	\$5.71
1+	\$5.95	\$5.95	\$5.95

A dark gray coarse polisher for precious and semi-precious. Leaves a brilliant satin finish that removes scratches and prepares the material for a high-shine gloss.

GRAY 180 Grit Flexible



Order #	11-8120	11-8122	11-8124	11-8126	11-8134
OD	7/8"	5/8"	7/8"	5/8"	1/4"
Thickness	1/8"	1/8"	1/8"	1/8"	7/8"
Shape	Square	Square	Knife-Edge	Knife-Edge	Cylinder
12+	\$5.47	\$5.47	\$5.47	\$5.47	\$5.47
6+	\$5.71	\$5.71	\$5.71	\$5.71	\$5.71
1+	\$5.95	\$5.95	\$5.95	\$5.95	\$5.95

One step harder than the dark gray, this wheel is more coarse and aggressive. Used for precious and non-precious. Excellent for deep scratches.

WHITE 180 Grit Hard



Order #	11-8136	11-8138	11-8140	11-8142
OD	7/8"	5/8"	7/8"	5/8"
Thickness	1/8"	1/8"	1/8"	1/8"
Shape	Square	Square	Knife-Edge	Knife-Edge
12+	\$5.47	\$5.47	\$5.47	\$5.47
6+	\$5.71	\$5.71	\$5.71	\$5.71
1+	\$5.95	\$5.95	\$5.95	\$5.95

A wheel made specifically for platinum and softer materials. Pre-polisher that leaves an extremely smooth finish and prepares for the final high-shine.

LIGHT GREEN 200 Grit



Order #	11-8144	11-8146	11-8148	11-8150
OD	7/8"	5/8"	7/8"	5/8"
Thickness	1/8"	1/8"	1/8"	1/8"
Shape	Square	Square	Knife-Edge	Knife-Edge
12+	\$5.47	\$5.47	\$5.47	\$5.47
6+	\$5.71	\$5.71	\$5.71	\$5.71
1+	\$5.95	\$5.95	\$5.95	\$5.95



UNMOUNTED SILICONE PRE-POLISH WHEELS

A soft silicone wheel for high gloss. Very smooth, leaving a brilliant glossy coat.



LIGHT BLUE
800 Grit



Order #	11-8172	11-8174
OD	7/8"	7/8"
Thickness	1/8"	1/8"
Shape	Square	Knife-Edge
12+	\$6.21	\$6.21
6+	\$6.48	\$6.48
1+	\$6.75	\$6.75



See page 32 for mandrels.

Final high shine polisher. Creates an incredible high gloss after the pre-polish stage. Very soft and extremely smooth. Unmatched performance with no need for rouge or compound.

PINK
1200 Grit



Order #	11-8152	11-8154	11-8156	11-8158	11-8162
OD	5/8"	5/8"	7/8"	5/8"	1/8"
Thickness	1/8"	1/8"	1/8"	1/8"	7/8"
Shape	Square	Square	Knife-Edge	Knife-Edge	Cylinder
12+	\$6.21	\$6.21	\$6.21	\$6.21	\$6.21
6+	\$6.48	\$6.48	\$6.48	\$6.48	\$6.48
1+	\$6.75	\$6.75	\$6.75	\$6.75	\$6.75

Used to remove light scratches quickly, leaving a smooth, even finish. Silicone-carbide abrasive allows medium fast cutting while the silicone rubber bond produces a smooth finish. Soft, flexible polishers for satin finishes. Made in Germany.

BLUE
Medium Flexible



Order #	11-6060	11-6061	11-6062	11-6063	11-6064
OD	5/8"	7/8"	5/8"	7/8"	5/16"
Thickness	1/8"	1/8"	1/8"	1/8"	13/16"
Shape	Square	Square	Knife-Edge	Knife-Edge	Cylinder
12+	\$0.60	\$0.60	\$0.60	\$0.60	\$0.60
6+	\$0.62	\$0.62	\$0.62	\$0.62	\$0.62
1+	\$0.65	\$0.65	\$0.65	\$0.65	\$0.65

Revolutionary green wheel for long-lasting and highly flexible polishers for precious metals. Made from the highest quality raw materials available. Soft, extremely flexible for a matte finish. Made in Germany.

GREEN
Medium



Order #	11-6080	11-6081	11-6082	11-6083	11-6084	11-6085	11-6086	11-6087	11-6088
OD	7/8"	5/8"	1/2"	5/16"	1/4"	7/8"	3/4"	5/8"	1/2"
Thickness	1/8"	1/8"	1/8"	13/16"	1"	1/8"	1/8"	1/8"	1/16"
Shape	Square	Square	Square	Cylinder	Bullet	Knife-Edge	Knife-Edge	Knife-Edge	Knife-Edge
12+	\$0.55	\$0.55	\$0.55	\$0.55	\$0.55	\$0.55	\$0.55	\$0.55	\$0.55
6+	\$0.59	\$0.59	\$0.59	\$0.59	\$0.59	\$0.59	\$0.59	\$0.59	\$0.59
1+	\$0.65	\$0.65	\$0.65	\$0.65	\$0.65	\$0.65	\$0.65	\$0.65	\$0.65



MOUNTED STULLER SELECT SYNTHETIC RUBBER POLISHERS

These flexible polishes are excellent for precious metals but also work well on brass, bronze, and other non-precious metals. Mounted acrylic, rubber polishes are slightly harder than silicone rubber and longer lasting. Safe for use with stones. These ready-to-use polishes are all mounted on 3/32" shank mandrels. Kit excludes smallest point.



Order #	Description	12+	6+	1+
11-6124	24-Piece Kit: 1 of each	\$30.59	\$31.92	\$33.25

BLUE Coarse



Order #	11-6121	11-6125	11-6126	11-6127	11-6128	11-6129	11-6130
OD	1/8"	1/4"	1/4"	5/8"	3/4"	5/8"	5/8"
Thickness	3/8"	3/4"	1 1/16"	1/8"	1/16"	1/8"	1/2"
Shape	Point	Point	Bullet	Knife-Edge	Knife-Edge	Square	Cylinder
12+	\$1.20	\$1.20	\$1.20	\$1.45	\$1.45	\$2.39	\$2.16
6+	\$1.35	\$1.35	\$1.35	\$1.53	\$1.53	\$2.50	\$2.34
1+	\$1.50	\$1.50	\$1.50	\$1.70	\$1.70	\$2.60	\$2.60

GRAY Medium



Order #	11-6131	11-6135	11-6136	11-6137	11-6138	11-6139	11-6140
OD	1/8"	1/4"	1/4"	5/8"	3/4"	5/8"	5/8"
Thickness	3/8"	3/4"	1 1/16"	1/8"	1/16"	1/8"	1/2"
Shape	Point	Point	Bullet	Knife-Edge	Knife-Edge	Square	Cylinder
12+	\$1.20	\$1.27	\$1.38	\$1.45	\$1.45	\$2.16	\$2.16
6+	\$1.35	\$1.35	\$1.44	\$1.53	\$1.53	\$2.34	\$2.34
1+	\$1.50	\$1.50	\$1.50	\$1.70	\$1.70	\$2.60	\$2.60

REDDISH BROWN Fine



Order #	11-6141	11-6145	11-6146	11-6147	11-6148	11-6149	11-6150
OD	1/8"	1/4"	1/4"	5/8"	3/4"	5/8"	5/8"
Thickness	3/8"	3/4"	1 1/16"	1/8"	1/16"	1/8"	1/2"
Shape	Point	Point	Bullet	Knife-Edge	Knife-Edge	Square	Cylinder
12+	\$1.20	\$1.20	\$1.20	\$1.36	\$1.36	\$2.16	\$2.16
6+	\$1.35	\$1.35	\$1.35	\$1.53	\$1.53	\$2.34	\$2.34
1+	\$1.50	\$1.50	\$1.50	\$1.70	\$1.70	\$2.60	\$2.60

GREEN Extra Fine



Order #	11-6151	11-6155	11-6156	11-6157	11-6158	11-6159	11-6160
OD	1/8"	1/4"	1/4"	5/8"	3/4"	5/8"	5/8"
Thickness	3/8"	3/4"	1 1/16"	1/8"	1/16"	1/8"	1/2"
Shape	Point	Point	Bullet	Knife-Edge	Knife-Edge	Square	Cylinder
12+	\$1.20	\$1.20	\$1.20	\$1.19	\$1.36	\$2.16	\$2.16
6+	\$1.35	\$1.35	\$1.35	\$1.36	\$1.53	\$2.34	\$2.34
1+	\$1.50	\$1.50	\$1.50	\$1.70	\$1.70	\$2.60	\$2.60



UNMOUNTED ACRYLIC POLISHERS

Unmounted acrylic polishers. Square wheels use mandrel 43-1280 or 43-1282. Cylinders use mandrel 43-1280 or 43-1286.

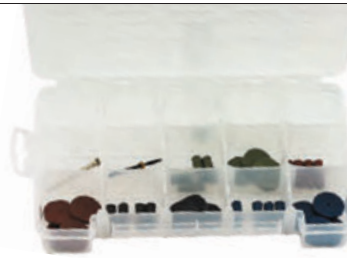

Order #	Description	12+	6+	1+
11-6194	33-Piece Acrylic Polishing Kit	\$14.90	\$15.55	\$16.20

SQUARE-EDGE WHEEL
7/8" x 1/8"

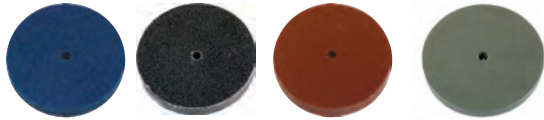

CYLINDER
5/16" x 13/16"



Order #	11-6185	11-6187	11-6189	11-6191
Grade	Coarse	Medium	Fine	Extra Fine
Color	Blue	Gray	Reddish Brown	Green
12+	\$0.64	\$0.64	\$0.64	\$0.64
6+	\$0.67	\$0.67	\$0.67	\$0.67
1+	\$0.70	\$0.70	\$0.70	\$0.70

Order #	11-6186	11-6188	11-6190	11-6192
Grade	Coarse	Medium	Fine	Extra Fine
Color	Blue	Gray	Reddish Brown	Green
12+	\$0.64	\$0.64	\$0.64	\$0.64
6+	\$0.67	\$0.67	\$0.67	\$0.67
1+	\$0.70	\$0.70	\$0.70	\$0.70

EVEFLEX TECHNIK SERIES 400

Hard and long-lasting polishers for non-precious alloys and model casting material. Use for grinding and pre-polishing, removing casting skin, non-precious metals and model casting. Very hard wear-resistant polishers offering a high level of material removal. Featuring a hard, flexible synthetic rubber binder.



BROWN
Medium

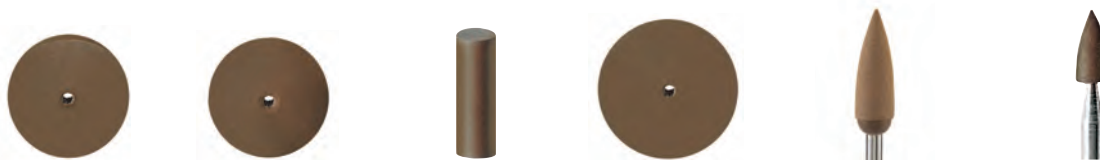

Order #	11-6520	11-6521	11-6522	11-6523	11-6524	11-6525
OD	7/8"	7/8"	5/16"	1 1/16"	1/4"	1/8"
Thickness	1/8"	3/16"	13/16"	1/16"	3/4"	3/8"
Shape	Square	Square	Cylinder	Square	Point	Point
12+	\$0.60	\$0.60	\$0.60	\$0.60	\$1.08	\$1.08
6+	\$0.68	\$0.68	\$0.68	\$0.68	\$1.22	\$1.22
1+	\$0.85	\$0.85	\$0.85	\$0.85	\$1.35	\$1.35

POLISHING RODS

Long-lasting, acrylic polishing rods give you a smooth finish in all of your hard-to-reach places. Excellent for use on non-precious and precious metals. Available in 2mm and 3mm diameters and five abrasive grades. Kits include 10 of each rod and a mandrel.



Order #	Grade	Color	OD	Length	12+	6+	1+
11-6165	Extra Coarse	Brown	2mm	20mm	\$0.83	\$0.86	\$0.90
11-6166	Hard	Blue	2mm	20mm	\$0.83	\$0.86	\$0.90
11-6167	Medium	Gray	2mm	20mm	\$0.83	\$0.86	\$0.90
11-6168	Fine	Reddish Brown	2mm	20mm	\$0.83	\$0.86	\$0.90
11-6169	Extra Fine	Green	2mm	20mm	\$0.83	\$0.86	\$0.90
11-6175	Extra Coarse	Brown	3mm	23mm	\$0.83	\$0.86	\$0.90
11-6176	Hard	Blue	3mm	23mm	\$0.83	\$0.86	\$0.90
11-6177	Medium	Gray	3mm	23mm	\$0.83	\$0.86	\$0.90
11-6178	Fine	Reddish Brown	3mm	23mm	\$0.83	\$0.86	\$0.90
11-6179	Extra Fine	Green	3mm	23mm	\$0.83	\$0.86	\$0.90
11-6171	51-Piece Kit Assortment				\$23.60	\$24.62	\$25.65
11-6181	51-Piece Kit Assortment				\$23.60	\$24.62	\$25.65
43-1300	2mm Mandrel (1/8" Arbor hole)				\$4.42	\$4.61	\$4.80
43-1301	3mm Mandrel (1/8" Arbor hole)				\$4.69	\$5.09	\$5.65



43-1300

43-1301

Abrasives



UNMOUNTED AIRFLEX POLISHERS

Excellent for all types of metal including titanium. Unmounted Airflex polishers provide a more flexible wheel than standard, heatless wheels. These new wheels are made with tiny air voids uniformly distributed through the wheel, providing a cool-running, flexible polishing wheel. These Airflex wheels aggressively remove material. Use mandrel 43-1280 or 43-1282.



Order #	Description	12+	6+	1+
11-6172	31-Piece Airflex Kit	\$20.52	\$21.41	\$22.30

SQUARE WHEEL

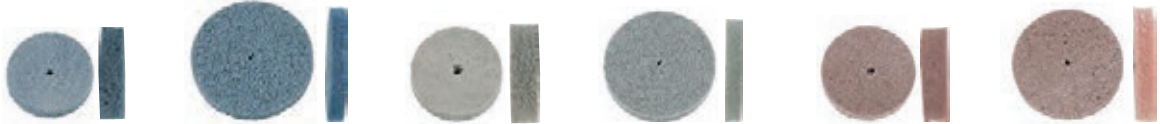

Order #	11-6193	11-6195	11-6196	11-6197	11-6198	11-6199
OD	5/8"	7/8"	5/8"	7/8"	5/8"	7/8"
Thickness	1 1/16"	1/8"	1/8"	1/8"	1/8"	1/8"
Grade	Coarse	Coarse	Medium	Medium	Fine	Fine
Shape	Square	Square	Square	Square	Square	Square
12+	\$0.74	\$0.74	\$0.68	\$0.68	\$0.68	\$0.68
6+	\$0.77	\$0.77	\$0.72	\$0.72	\$0.72	\$0.72
1+	\$0.80	\$0.80	\$0.80	\$0.80	\$0.80	\$0.80

CERAMIC POLISHING WHEELS

Ceramic-infused polishing wheels for smoothing and polishing precious metals, including platinum, gold, silver, and titanium. Available in six color-coded grits, these wheels work faster and last longer than other polishers. Use with mandrel 43-1280.



Order #	Grit	Color	OD x Thickness	12+	6+	1+
11-6090	10-Piece Kit: 2 of each			\$11.27	\$11.76	\$12.25
11-6091	1500	White	7/8" x 1/8"	\$11.27	\$11.76	\$12.25
11-6092	1000	Gray	7/8" x 1/8"	\$11.27	\$11.76	\$12.25
11-6093	500	Orange	7/8" x 1/8"	\$11.27	\$11.76	\$12.25
11-6094	320	Violet	7/8" x 1/8"	\$11.27	\$11.76	\$12.25
11-6095	180	Green	7/8" x 1/8"	\$11.27	\$11.76	\$12.25
11-6096	120	Blue	7/8" x 1/8"	\$11.27	\$11.76	\$12.25

UNMOUNTED STULLER PREMIUM SWISS STEEL POLISHERS

The most abrasive and toughest polishers for stainless steel and chrome-cobalt alloys. Available in three grits: coarse, medium, and fine. Available in unmounted only. Made in Switzerland.



Order #	11-6350	11-6351	11-6353	11-6354	11-6356	11-6357
OD	1/4"	7/8"	1/4"	7/8"	1/4"	7/8"
Thickness	7/8"	1/8"	7/8"	1/8"	7/8"	1/8"
Grade	Coarse	Coarse	Medium	Medium	Fine	Fine
Shape	Cylinder	Square	Cylinder	Square	Cylinder	Square
12+	\$0.69	\$0.69	\$0.69	\$0.69	\$0.69	\$0.69
6+	\$0.72	\$0.72	\$0.72	\$0.72	\$0.72	\$0.72
1+	\$0.75	\$0.75	\$0.75	\$0.75	\$0.75	\$0.75

STULLER PREMIUM PLATINUM AND GEMSTONE POLISHERS

Premium polishers for platinum and gemstones. Three-step process produces a high gloss luster on platinum. Made in Switzerland.

WHITE
Eliminates Scratches



Order #	11-6360	11-6361	11-6362	11-6363	11-6364
OD	1/4"	1/4"	1/4"	7/8"	7/8"
Thickness	7/8"	5/8"	1 1/16"	1/8"	1/8"
Shape	Cylinder	Point	Bullet	Knife-Edge	Square
12+	\$0.87	\$1.66	\$1.66	\$0.87	\$0.87
6+	\$0.91	\$1.73	\$1.73	\$0.91	\$0.91
1+	\$0.95	\$1.80	\$1.80	\$0.95	\$0.95

PINK
Repair Structure



Order #	11-6366	11-6367	11-6368	11-6369	11-6370
OD	1/4"	1/4"	1/4"	7/8"	7/8"
Thickness	7/8"	5/8"	1 1/16"	1/8"	1/8"
Shape	Cylinder	Point	Bullet	Knife-Edge	Square
12+	\$0.87	\$1.66	\$1.66	\$0.87	\$0.87
6+	\$0.91	\$1.73	\$1.73	\$0.91	\$0.91
1+	\$0.95	\$1.80	\$1.80	\$0.95	\$0.95

GRAY
High Gloss Finish



Order #	11-6372	11-6373	11-6374	11-6375	11-6376	11-6371
OD	1/4"	5/8"	5/8"	7/8"	7/8"	1/4"
Thickness	1 1/16"	1/8"	1/8"	1/8"	1/8"	5/8"
Shape	Point	Bullet	Knife-Edge	Square	Knife-Edge	Square
12+	\$1.66	\$1.66	\$1.66	\$1.66	\$0.87	\$0.87
6+	\$1.73	\$1.73	\$1.73	\$1.73	\$0.91	\$0.91
1+	\$1.80	\$1.80	\$1.80	\$1.80	\$0.95	\$0.95

CHROME ALLOYS, STAINLESS STEEL, AND TITANIUM POLISHERS

Designed for use on high-strength alloys for preparing and high-gloss polishing. Controllable handling with a high level of material removal. Hard, flexible synthetic rubber binder.



Order #	11-6530	11-6531	11-6532	11-6533	11-6534	11-6535	11-6540	11-6541	11-6542	11-6543	11-6544	11-6545
OD	7/8"	7/8"	7/8"	1/4"	1/4"	5/8"	7/8"	7/8"	7/8"	1/4"	1/4"	5/8"
Thickness	1/8"	1/16"	3/16"	7/8"	1 1/16"	7/8"	1/8"	1/16"	3/16"	7/8"	1 1/16"	7/8"
Shape	Square	Square	Square	Cylinder	Point	Square	Square	Square	Knife-Edge	Cylinder	Point	Square
12+	\$0.60	\$0.60	\$0.60	\$0.60	\$1.08	\$1.12	\$0.60	\$0.60	\$0.60	\$0.60	\$1.08	\$1.12
6+	\$0.68	\$0.68	\$0.68	\$0.68	\$1.22	\$1.26	\$0.68	\$0.68	\$0.68	\$0.68	\$1.22	\$1.26
1+	\$0.85	\$0.85	\$0.85	\$0.85	\$1.35	\$1.40	\$0.85	\$0.85	\$0.85	\$0.85	\$1.35	\$1.40

Abrasives

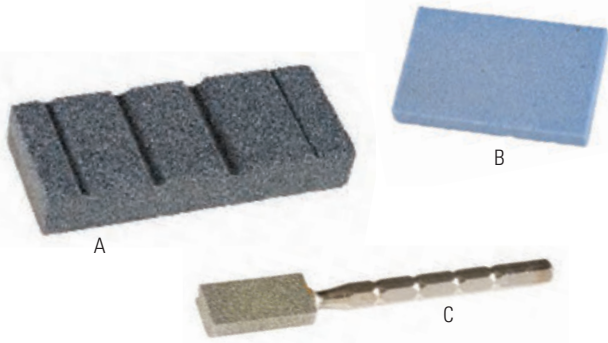

DIAMOND COATED DRESSING STONE

This diamond-coated block allows fast dressing and shaping of silicone and rubber polishers.

BLUE DRESSING STONE

Light blue abrasive stone used to shape and contour polishers.

DRESSING STONE

Hard, coarse, silicon-carbide block with various-sized, half-round grooves for cleaning and reshaping abrasive points and wheels.

Item	Order #	Description	W x L	Thickness	12+	6+	1+
A	10-4080	Dressing Stone	1 3/8" x 3 1/2"	3/16"	\$6.26	\$6.53	\$6.80
B	11-6260	Blue Stone	7/8" x 1"	3/16"	\$3.13	\$3.26	\$3.40
C	11-6261	Diamond Coated	1/2" x 1"	1/4"	\$45.28	\$49.10	\$54.55

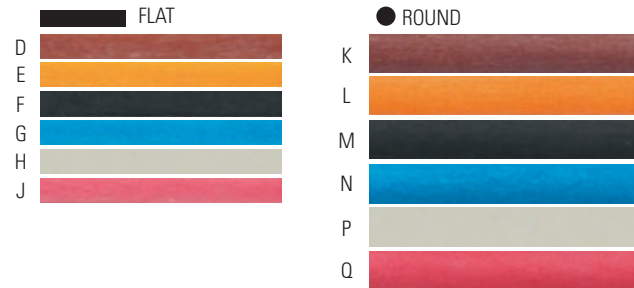

CERAMIC STONES

Ceramic stones are designed for stoning tight corners, pockets, ribs, and slots. One of our most popular series of finishing stones, these are ideal for finishing EDM surfaces. Ceramic super stones will withstand considerable pressure for their relative thinness. The grit of the ceramic fiber is exposed in the cross section of the stones.

Item	Order #	Grit	Color	W x L	Thickness	12+	6+	1+
FLAT								
D	21-1200	300	Light Brown	2" x 1"	4"	\$10.63	\$11.09	\$11.55
E	21-1201	400	Orange	2" x 1"	4"	\$10.63	\$11.09	\$11.55
F	21-1202	600	Brown	2" x 1"	4"	\$10.63	\$11.09	\$11.55
G	21-1203	800	Blue	2" x 1"	4"	\$10.63	\$11.09	\$11.55
H	21-1204	1000	White	2" x 1"	4"	\$10.63	\$11.09	\$11.55
J	21-1205	1200	Red	2" x 1"	4"	\$10.63	\$11.09	\$11.55
ROUND								
K	21-1206	300	Light Brown	2" x 1"	2"	\$23.87	\$24.91	\$25.95
L	21-1207	400	Orange	2" x 3 1/2"		\$24.38	\$25.44	\$26.50
M	21-1208	600	Brown	2" x 3 1/2"		\$24.38	\$25.44	\$26.50
N	21-1209	800	Blue	2" x 3 1/2"		\$24.38	\$25.44	\$26.50
P	21-1210	1000	White	2" x 3 1/2"		\$24.38	\$25.44	\$26.50
Q	21-1211	1200	Red	2" x 3 1/2"		\$24.38	\$25.44	\$26.50

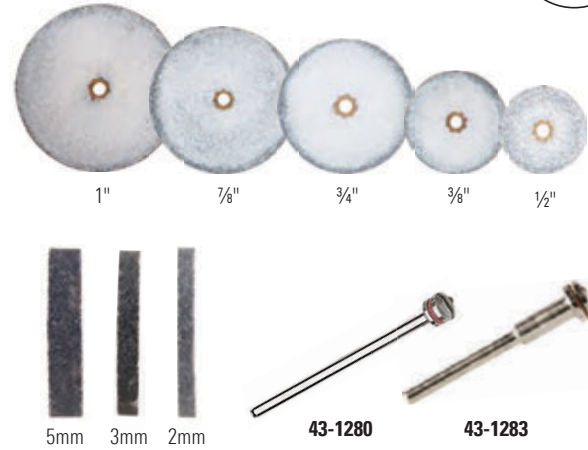

GENUINE HEATLESS® "MIZZY" WHEELS

These unique square-edge wheels are made from silicone carbide and a non-loading binder. Heatless "Mizzy" Wheels can be used for fast grinding or preparing contact finishes and texturing. Mandrels sold separately.



Order #	Width	OD	Thickness	Per Pack	12+	6+	1+
11-4400	5mm	1"	3/16"	Pack of 10	\$5.01	\$5.23	\$5.45
11-4390	3mm	1"	1/8"	Pack of 10	\$5.01	\$5.23	\$5.45
11-4380	2mm	1"	1/16"	Pack of 10	\$5.01	\$5.23	\$5.45
11-4370	5mm	7/8"	3/16"	Pack of 10	\$5.01	\$5.23	\$5.45
11-4360	3mm	7/8"	1/8"	Pack of 10	\$5.01	\$5.23	\$5.45
11-4350	2mm	7/8"	3/16"	Pack of 10	\$5.01	\$5.23	\$5.45
11-4340	5mm	3/4"	3/16"	Pack of 10	\$5.01	\$5.23	\$5.45
11-4330	3mm	3/4"	1/8"	Pack of 10	\$5.01	\$5.23	\$5.45
11-4320	2mm	3/4"	1/16"	Pack of 10	\$5.01	\$5.23	\$5.45
11-4310	5mm	3/8"	3/16"	Pack of 10	\$5.01	\$5.23	\$5.45
11-4300	3mm	3/8"	1/8"	Pack of 10	\$5.01	\$5.23	\$5.45
11-4290	2mm	3/8"	1/16"	Pack of 10	\$5.01	\$5.23	\$5.45
11-4280	5mm	1/2"	3/16"	Pack of 10	\$5.01	\$5.23	\$5.45
11-4270	3mm	1/2"	1/8"	Pack of 10	\$5.01	\$5.23	\$5.45
11-4260	2mm	3/16"	1/16"	Pack of 10	\$5.01	\$5.23	\$5.45
11-4401	5mm	1"	3/16"	Pack of 50	\$22.26	\$23.23	\$24.20
11-4391	3mm	1"	1/8"	Pack of 50	\$22.26	\$23.23	\$24.20
11-4381	2mm	1"	1/16"	Pack of 50	\$22.26	\$23.23	\$24.20
11-4371	5mm	7/8"	3/16"	Pack of 50	\$22.26	\$23.23	\$24.20
11-4361	3mm	7/8"	1/8"	Pack of 50	\$22.26	\$23.23	\$24.20
11-4351	2mm	7/8"	3/16"	Pack of 50	\$22.26	\$23.23	\$24.20
11-4341	5mm	3/4"	3/16"	Pack of 50	\$22.26	\$23.23	\$24.20
11-4331	3mm	3/4"	1/8"	Pack of 50	\$22.26	\$23.23	\$24.20
11-4321	2mm	3/4"	1/16"	Pack of 50	\$22.26	\$23.23	\$24.20
11-4311	5mm	3/8"	3/16"	Pack of 50	\$22.26	\$23.23	\$24.20
11-4301	3mm	3/8"	1/16"	Pack of 50	\$22.26	\$23.23	\$24.20
11-4291	2mm	3/8"	1/16"	Pack of 50	\$22.26	\$23.23	\$24.20
11-4281	5mm	1/2"	3/16"	Pack of 50	\$22.26	\$23.23	\$24.20
11-4271	3mm	1/2"	1/8"	Pack of 50	\$22.26	\$23.23	\$24.20
11-4261	2mm	1/2"	1/16"	Pack of 50	\$22.26	\$23.23	\$24.20
43-1280	Reinforced Screw Mandrel (3/32" shank)				\$0.89	\$0.95	\$1.05
43-1283	1/8" Mandrel (1/8" shank with one silver cap for 1/8" and 1/4" thick wheels)				\$1.44	\$1.62	\$1.80

CYLINDER POLISHING KIT

Specially designed cylinders for polishing inside rings. Eliminates the use of sand paper rolls. 14-piece kit includes: coarse 180 (blue), fine 220 (gray), extra-fine 800 (green), high-shine 1200 (pink), and two inside ring mandrels (1 - 43-1288 and 1 - 43-1289).



Order #	Description	12+	6+	1+
11-6620	Starter Kit	\$21.39	\$22.32	\$23.25



Order #	11-8180	11-8182	11-8184	11-8186
OD	1/2"	1/2"	1/2"	1/2"
Thickness	1"	1"	1"	1"
Grit	180 Coarse	220 Coarse	800 Coarse	1200 High Shine
12+	\$5.27	\$5.27	\$5.27	\$5.27
6+	\$5.72	\$5.72	\$5.72	\$5.72
1+	\$6.35	\$6.35	\$6.35	\$6.35

JUMBO CYLINDER MANDRELS

Nickel-plated small wheel mandrels.

Item	Order #	Description	Shank Size	12+	6+	1+
A	43-1288	Stainless Steel	3/32"	\$2.66	\$2.88	\$3.20
B	43-1289	Stainless Steel	1/8"	\$2.66	\$2.88	\$3.20

STULLER PREMIUM RUBBER POLISHERS

Rubber polishers used for gold and other precious and semi-precious alloys. Made in Switzerland.



BROWN
Pre-Polish



Order #	11-6300	11-6301	11-6302	11-6303	11-6304	11-6305	11-6307	11-6308
OD	1/4"	1/4"	5/8"	7/8"	5/8"	5/8"	1/8"	1/4"
Thickness	5/8"	1 1/16"	1/8"	1/16"	1/8"	1/2"	7/8"	7/8"
Shape	Point	Bullet	Knife-Edge	Knife-Edge	Square	Cylinder	Square	Cylinder
12+	\$1.47	\$1.47	\$1.93	\$1.93	\$2.62	\$2.62	\$0.74	\$0.74
6+	\$1.54	\$1.54	\$2.02	\$2.02	\$2.74	\$2.74	\$0.77	\$0.77
1+	\$1.60	\$1.60	\$2.10	\$2.10	\$2.85	\$2.85	\$0.80	\$0.80

GREEN
High Gloss



Order #	11-6310	11-6312	11-6313	11-6315	11-6316	11-6317	11-6318
OD	1/4"	5/8"	7/8"	5/8"	7/8"	7/8"	1/4"
Thickness	5/8"	1/8"	1/16"	1/2"	1/16"	1/8"	7/8"
Shape	Point	Knife-Edge	Knife-Edge	Cylinder	Square	Square	Cylinder
12+	\$1.61	\$2.07	\$1.91	\$2.62	\$0.74	\$0.74	\$0.74
6+	\$1.68	\$2.16	\$2.03	\$2.74	\$0.77	\$0.77	\$0.77
1+	\$1.75	\$2.25	\$2.25	\$2.85	\$0.80	\$0.80	\$0.80

GREEN
Ultra-High Shine



Order #	11-6320	11-6322
OD	1/4"	9/16"
Thickness	1 1/16"	1/8"
Shape	Bullet	Square
12+	\$1.52	\$1.52
6+	\$1.58	\$1.58
1+	\$1.65	\$1.65

Abrasives

TITANIUM AND PLATINUM HIGH-PERFORMANCE POLISHING WHEELS

High-performance polishing wheels available in a medium grit and an extra-fine grit for high-luster polishing. Made in Germany from the highest quality raw materials available. Use mandrels 43-1280 or 43-1282.

GRAY Medium



Order #	11-6262	11-6263	11-6264	11-6265	11-6266	11-6267	11-6268	11-6269
OD	7/8"	7/8"	1/8"	7/8"	7/8"	7/8"	7/8"	7/8"
Thickness	1/8"	1/8"	1/8"	1/8"	1/8"	1/8"	1/8"	1/8"
Shape	Square	Knife-Edge	Cylinder	Cylinder	Bullet	Cylinder	Square	Knife-Edge
12+	\$0.55	\$0.55	\$0.55	\$1.66	\$1.66	\$1.91	\$1.66	\$1.66
6+	\$0.59	\$0.59	\$0.59	\$1.73	\$1.73	\$2.03	\$1.73	\$1.73
1+	\$0.65	\$0.65	\$0.65	\$1.80	\$1.80	\$2.25	\$1.80	\$1.80

LILAC Extra Fine



Order #	11-6270	11-6271	11-6272	11-6273	11-6274	11-6275	11-6276	11-6277
OD	7/8"	7/8"	1/8"	5/16"	5/8"	9/16"	5/8"	5/8"
Thickness	1/8"	1/8"	15/16"	13/16"	11/16"	1/2"	1/8"	1/8"
Shape	Square	Knife-Edge	Cylinder	Cylinder	Bullet	Cylinder	Square	Knife-Edge
12+	\$0.55	\$0.55	\$0.55	\$1.66	\$1.66	\$1.91	\$1.66	\$1.66
6+	\$0.59	\$0.59	\$0.59	\$1.73	\$1.73	\$2.03	\$1.73	\$1.73
1+	\$0.65	\$0.65	\$0.65	\$1.80	\$1.80	\$2.25	\$1.80	\$1.80



DIAMOND-IMPREGNATED POLISHING KIT

Platinum diamond-impregnated polishing kit contains nine polishers. Long-lasting, high performance, rubber polishers create a high luster quickly. Work especially well with platinum, tungsten and glass. These individual polishers are mounted and ready to use. One of each fineness of the point, disc, and square-edge polishers (11mm x 14mm) are included in the kit. Shanks are 3/32".

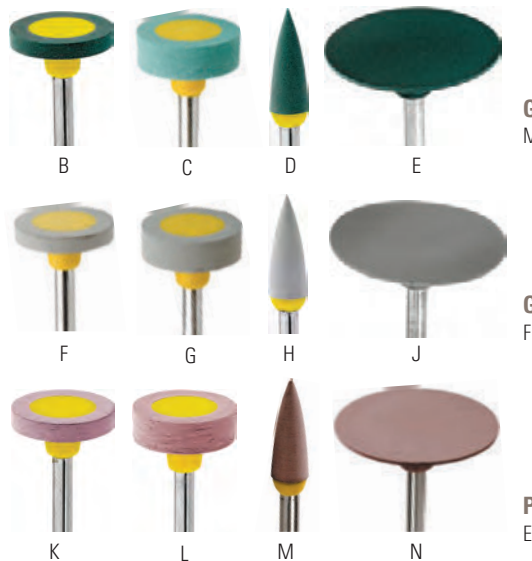

GREEN/YELLOW Medium

GREY/YELLOW Fine

PINK/YELLOW Extra Fine

Item	Order #	Description	12+	6+	1+	
A	11-6200	9-Piece Polishing Kit	\$103.41	\$107.90	\$112.40	
Item	Shape	OD	Thickness	12+	6+	1+
B	Square-Edge	7/16"	1/8"	\$10.26	\$10.70	\$11.15
C	Square-Edge	7/16"	3/16"	\$17.53	\$18.29	\$19.05
D	Point	3/16"	9/16"	\$10.26	\$10.70	\$11.15
E	Flex Disc	3/4"	1/16"	\$17.53	\$18.29	\$19.05
F	Square-Edge	7/16"	1/8"	\$10.26	\$10.70	\$11.15
G	Square-Edge	7/16"	3/16"	\$17.53	\$18.29	\$19.05
H	Point	3/16"	9/16"	\$10.26	\$10.70	\$11.15
J	Flex Disc	3/4"	1/16"	\$17.53	\$18.29	\$19.05
K	Square	11"	2"	\$10.26	\$10.70	\$11.15
L	Square-Edge	7/16"	3/16"	\$17.53	\$18.29	\$19.05
M	Point	3/16"	9/16"	\$10.26	\$10.70	\$11.15
N	Flex Disc	3/4"	1/16"	\$17.53	\$18.29	\$19.05



RUBY POWDER

Intended for use with hand buffs, brushes, felts and wood laps. Can be mixed with water or fine oil to form a 5000 grit polishing paste that will impart a high luster. The Ruby powder gives a high luster to platinum, gold, steel, precious stones, pearl, ivory, horn shell and porcelain.

Order #	Description	Grit	12+	6+	1+
59-1039	High Shine Polishing Powder	5000	\$5.65	\$5.99	\$6.65



GEM SHINE POLISHING WHEELS

Polishing wheels designed for removing light surface scratches from soft stones such as onyx, cabochons, and opals. The Gem Shine wheels are impregnated with a polishing paste to provide scratch removal and a final polish on the stone's surface. Comes with five wheels and a reinforced mandrel.



Order #	Description	12+	6+	1+
11-6065	Gem Shine Kit	\$20.57	\$21.78	\$24.20

MIRACLE GOLD SILICONE WHEEL

The industry's absolute finest rubberized abrasive for final polishing of gold and semi-precious metals. Eliminates the need for rouge. Use mandrel 43-1281.



Item	Order #	Shape	Outside Diameter	Thickness	12+	6+	1+
A	11-6072	Knife-Edge	7/8"	1/8"	\$17.20	\$17.95	\$18.70
B	11-6074	Square	7/8"	1/8"	\$17.20	\$17.95	\$18.70



PUMICE POLISHERS

Excellent for use on prong and bezel finishing with set stones. Provides safe polishing around precious and synthetic stones. Contains a silicone binder, which provides more durability.



GOLD
Medium



Order #	11-6244	11-6245	11-6246	11-6292	11-6290	11-6291	11-6249
OD	5/8"	7/8"	7/8"	5/8"	1/4"	5/8"	5/8"
Thickness	1/8"	1/8"	1/8"	1/16"	1/16"	1/8"	1/8"
Shape	Square	Square	Knife-Edge	Knife-Edge	Point	Square	Knife-Edge
12+	\$0.68	\$0.56	\$0.68	\$1.62	\$1.62	\$1.62	\$0.68
6+	\$0.72	\$0.64	\$0.72	\$1.71	\$1.71	\$1.71	\$0.72
1+	\$0.80	\$0.80	\$0.80	\$1.90	\$1.90	\$1.90	\$0.80

GRAY
Medium



Order #	11-6293	11-6247	11-6294	11-6248	11-6295	11-6296	11-6297
OD	5/8"	7/8"	5/8"	7/8"	1/4"	5/8"	5/8"
Thickness	1/8"	1/8"	1/8"	1/8"	1 1/16"	1/8"	1/16"
Shape	Square	Square	Knife-Edge	Knife-Edge	Point	Square	Knife-Edge
12+	\$0.68	\$0.56	\$0.68	\$0.56	\$1.62	\$1.62	\$1.62
6+	\$0.72	\$0.64	\$0.72	\$0.64	\$1.71	\$1.71	\$1.71
1+	\$0.80	\$0.80	\$0.80	\$0.80	\$1.90	\$1.90	\$1.90

JEWELER'S PUMICE POLISHERS

Rubberized pumice polishers provide a very fine result for finishing and a final polish for gold and semi-precious metals. Will not scratch stones. Extra-long lasting.

Item	Order #	Shape	Outside Diameter	Thickness	12+	6+	1+
C	11-6280	Square-Edge	5/8"	1/8"	\$0.94	\$0.99	\$1.10
D	11-6281	Square-Edge	7/8"	1/8"	\$0.94	\$0.99	\$1.10
E	11-6282	Knife-Edge	5/8"	1/8"	\$0.94	\$0.99	\$1.10
F	11-6283	Knife-Edge	7/8"	1/8"	\$0.94	\$0.99	\$1.10

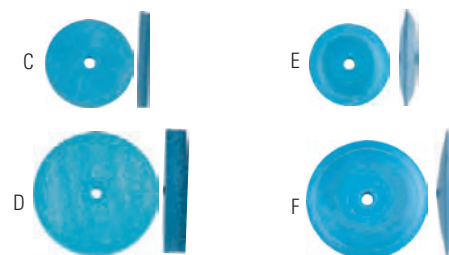

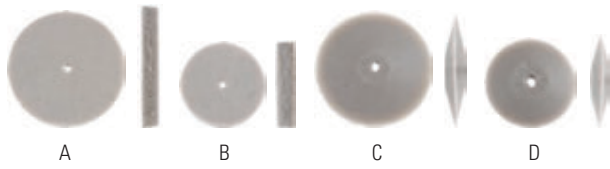

SILICONE PUMICE WHEELS

Unique pumice wheel mixed with silicone to last longer than standard pumice wheels. Safe for use on soft stones. Use with mandrels 43-1280 or 43-1281.



Item	Order #	Shape	OD	Thickness	12+	6+	1+
A	11-8164	Square	7/8"	1/8"	\$3.83	\$4.05	\$4.50
B	11-8166	Square	5/8"	1/8"	\$3.83	\$4.05	\$4.50
C	11-8168	Knife-Edge	7/8"	1/8"	\$3.83	\$4.05	\$4.50
D	11-8170	Knife-Edge	5/8"	1/8"	\$3.74	\$4.05	\$4.50

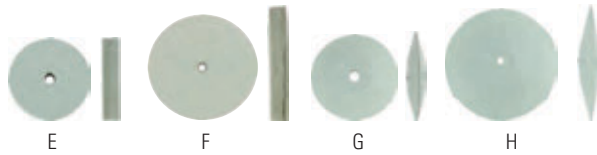

ALL IN ONE POLISHERS

Introducing a new breakthrough polishing line. The "All in One" polishers allow you to polish and shine in one step. Ideal for touch-ups. Suitable for precious metals and stones. Long lasting and won't scratch stones. Unmounted. Use with mandrel 43-1281.

Item	Order #	Shape	OD	Thickness	12+	6+	1+
E	11-6600	Square	5/8"	1/8"	\$0.79	\$0.86	\$0.95
F	11-6601	Square	7/8"	1/8"	\$0.79	\$0.86	\$0.95
G	11-6602	Knife-Edge	5/8"	1/8"	\$0.79	\$0.86	\$0.95
H	11-6603	Knife-Edge	7/8"	1/8"	\$0.79	\$0.86	\$0.95



STAINLESS STEEL MINIATURE MANDRELS

Long-lasting, acrylic polishing rods give you a smooth finish in all of your hard-to-reach places. Excellent for use on non-precious and precious metals. Available in 2mm and 3mm diameters and five abrasive grades. Kits include 10 of each rod and a mandrel.

Item	Order #	Description	Shank Size	12+	6+	1+
J	43-1300	2mm Mandrel	3/32"	\$4.42	\$4.61	\$4.80
K	43-1301	3mm Mandrel	3/32"	\$4.69	\$5.09	\$5.65
L	43-1302	Mandrel	3/32"	\$1.41	\$1.53	\$1.70
M	43-1303	Reinforced	3/32"	\$1.41	\$1.53	\$1.70
N	43-1304	1/8" Standard	3/32"	\$1.62	\$1.76	\$1.95
P	43-1305	14mm Wheel	3/32"	\$0.00	\$0.00	\$1.80
Q	43-1306	8mm Wheel	3/32"	\$2.39	\$2.50	\$2.60



NICKEL-PLATED MINIATURE MANDRELS

Nickel-plated small wheel mandrels.

Item	Order #	Description	Shank Size	12+	6+	1+
R	43-1280	Reinforced Screw Mandrel	3/32"	\$0.89	\$0.95	\$1.05
S	43-1281	Standard Screw Mandrel	3/32"	\$0.74	\$0.84	\$1.05
T	43-1282	Heavy Duty Mandrel	3/32"	\$1.47	\$1.68	\$2.10
U	43-1283	1/8" Mandrel (1/8" shank with one silver cap for 1/8" and 1/4" thick wheels)		\$1.44	\$1.62	\$1.80
V	43-1286	Stainless Steel	3/32"	\$0.74	\$0.84	\$1.05
W	43-1284	3/8" Crew Stainless Steel	3/32"	\$0.64	\$0.68	\$0.75
Y	43-1288	Stainless Steel	3/32"	\$2.66	\$2.88	\$3.20
Z	43-1289	Stainless Steel	1/8"	\$2.66	\$2.88	\$3.20
AA	10-7050	Snap-On Mandrel	3/32"	\$1.70	\$1.85	\$2.05



SPLIT MANDRELS FOR HANDPIECES

Emery paper is wrapped around this mandrel and used for polishing smaller pieces.

Item	Order #	Description	Length	Shank Size	12+	6+	1+
AB	11-3009	Tapered	2 1/4"	3/32"	\$1.36	\$1.53	\$1.70
AC	11-3010	Slim	2 1/4"	3/32"	\$1.33	\$1.44	\$1.60

TAPERED SPINDLE ADAPTERS

MX Polishing Wheel features a consistent premium grade of silicone-carbide mineral along with brightness enhancers that result in controllable, consistent finishing and polishing of metal parts.

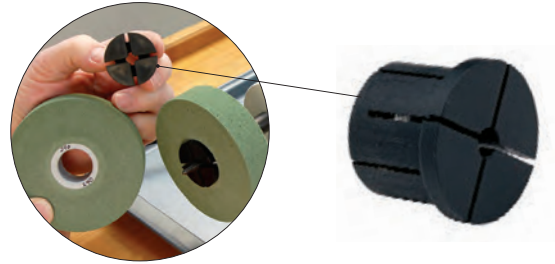

Order #	Hole ID	12+	6+	1+
10-8208	1"	\$5.61	\$5.86	\$6.10

EXL II WHEELS

This wheel is a more aggressive wheel than the light deburring wheel. Excellent for rapid removal of sprues, parting lines, and fire scale. Wheels are 6" x 1" and have a 1" center hole. Be sure to order the correct adapter to fit your size motor shaft.



Order #	Grade	OD	Thickness	Hole ID	12+	6+	1+
10-8128	Medium	6"	1"	1"	\$62.70	\$65.42	\$68.15
10-8127	Fine	1/4"	1/16"	1"	\$67.34	\$70.27	\$73.20

LIGHT DEBURRING WHEELS

These light deburring wheels have been the #1 choice of jewelry manufacturers for years. Excellent for sprue removal. Wheels are 6" in diameter and have a 1" center hole. Flanges not included. 1" wheel adapter. Two pieces used for wheels with 1" center hole. Order wheel adapter to fit your shaft diameter.



Order #	Grade	OD	Thickness	Hole ID	12+	6+	1+
10-8182	Medium	6"	1"	1"	\$60.49	\$63.12	\$65.75
10-8181	Fine	6"	1"	1"	\$55.61	\$58.03	\$60.45

STULLER ABRASIVE CLOTH FLAP WHEELS

Used for light deburring when the casting is not so advanced and scarred. Leaves a typical deep straight mark of the abrasive cloth on the surface, masked by the satin pattern of the abrasive. Use adapter 10-8208.

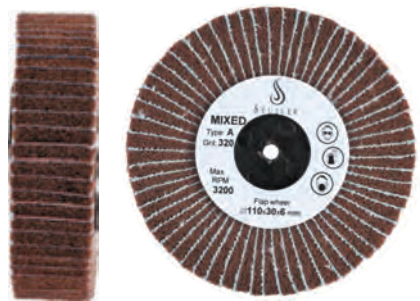

Order #	Grit	OD	Thickness	12+	6+	1+
10-7060	120	3/16"	1/16"	\$14.37	\$15.21	\$16.90
10-7061	180	3/16"	1/16"	\$14.37	\$15.21	\$16.90
10-7062	240	3/16"	1/16"	\$14.37	\$15.21	\$16.90
10-7063	280	3/16"	1/16"	\$14.37	\$15.21	\$16.90
10-7064	320	3/16"	1/16"	\$14.37	\$15.21	\$16.90
10-7065	400	3/16"	1/16"	\$14.37	\$15.21	\$16.90

Abrasives



CLEAN AND FINISH BUFFS

High-stretch, clean and finish buffs provide a fast, consistent, and beautiful satin finish. These 1/4" thick discs can be stacked to get the thickness you need.

Order #	Grade	OD	12+	6+	1+
10-8120	Medium	4"	\$2.44	\$2.54	\$2.65
10-8121	Fine	4"	\$2.07	\$2.16	\$2.25
10-8190	Extra Fine	4"	\$2.12	\$2.21	\$2.30
10-8191	Medium	6"	\$4.14	\$4.32	\$4.50
10-8192	Fine	6"	\$3.13	\$3.26	\$3.40
10-8193	Extra Fine	6"	\$0.00	\$0.00	\$0.00

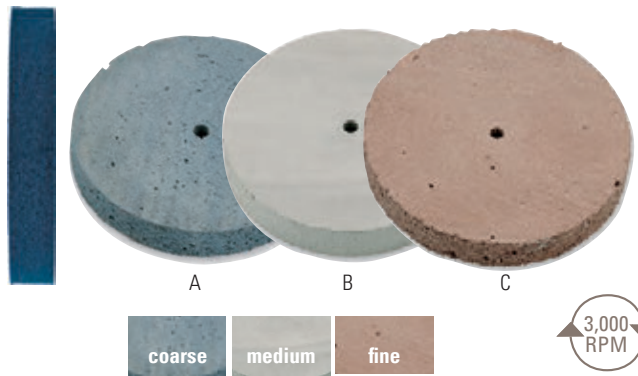

UNMOUNTED AIRFLEX POLISHING WHEELS

These new wheels are made with tiny air voids uniformly distributed throughout the wheel. This provides a cool running, flexible polishing wheel excellent for use on precious alloys, platinum, titanium, and stainless steel. Use with wheel mandrel 34-2013 and 34-2014.

Item	Order #	Grade	OD	Thickness	ID	12+	6+	1+
A	11-6255	Coarse	4"	5/8"	1/4"	\$18.58	\$19.39	\$20.20
B	11-6256	Medium	4"	5/8"	1/4"	\$18.58	\$19.39	\$20.20
C	11-6257	Fine	4"	5/8"	1/4"	\$18.58	\$19.39	\$20.20



STULLER ALUMINUM-OXIDE FLAP WHEELS

The most popular item in the jewelry world. Used for every kind of satin finishing pattern, from the roughest (Grit A/Coarse) to the finest (Grit/Ultra-Fine).

Order #	Material	Grade	OD x Thickness	12+	6+	1+
10-7070	Scotch Brite	Coarse	4" x 1"	\$9.61	\$10.17	\$11.30
10-7071	Scotch Brite	Medium	4" x 1"	\$9.61	\$10.17	\$11.30
10-7072	Scotch Brite	Fine	4" x 1"	\$9.61	\$10.17	\$11.30
10-7073	Aluminum Oxide	Extra Fine	4" x 1"	\$9.61	\$10.17	\$11.30
10-7074	Aluminum Oxide	Fine	4" x 1"	\$9.61	\$10.17	\$11.30
10-7075	Aluminum Oxide	Super Fine	4" x 1"	\$9.61	\$10.17	\$11.30
10-7076	Aluminum Oxide	Ultra-Fine	4" x 1"	\$9.61	\$10.17	\$11.30



PREMIUM SILICONE POLISHING WHEELS

Requires no rouge or Tripoli. Each wheel is impregnated with carefully graded, silicone-carbide abrasive. Available in several grades. Measures 4" diameter x 15mm thick with 1/2" center hole. Use with 47-2560, 3/32" wheel arbor.

Item	Order #	Grade	Color	OD x Thickness	Hole ID	1+
D	11-6250	Coarse	White	4" x 3/8"	1/2"	\$20.40
E	11-6251	Medium	Black	4" x 3/8"	1/2"	\$20.35
F	11-6252	Fine	Blue	4" x 3/8"	1/2"	\$13.44
G	11-6253	Extra Fine	Pink	4" x 3/8"	1/2"	\$20.40

MINIMAT BRUSH WITH MANDREL

A. The .3mm Minimat brush allows you to quickly put a fine textured finish on bands or other fine jewelry.

B. The .45mm Minimat brush allows you to quickly put a medium textured finish on bands or other fine jewelry.

C. The .6mm Minimat brush allows you to quickly put a coarse textured finish on bands or other fine jewelry.



Item	Order #	Description	12+	6+	1+
A	11-7100	.3mm	\$36.42	\$38.57	\$42.85
B	11-7100	.45mm	\$36.42	\$38.57	\$42.85
C	11-7100	.6mm	\$36.42	\$38.57	\$42.85

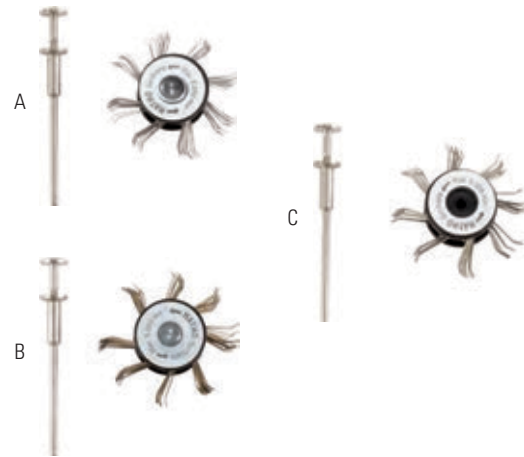

MINIMAT BRUSH SET WITH MANDREL

The Minimat brush set comes complete with one wheel, one mandrel, and one set of each size of pins. Use this set to create fine, medium, and coarse textures on bands or other fine jewelry.

Order #	Description	12+	6+	1+
11-7101	.3, .45, and .6mm	\$56.36	\$59.67	\$66.30



PRIMO® FLAP BRUSH

Quality abrasive ideal for creating satin finishes.

Order #	Color	OD x Thickness	Inside Diameter	12+	6+	1+
10-8321	Brown	5" x 1"	1/4"	\$18.54	\$19.34	\$20.15
10-8321	Purple	5" x 1"	1/4"	\$18.54	\$19.34	\$20.15
10-8321	Green	5" x 1"	1/4"	\$18.54	\$19.34	\$20.15
10-8321	Gray	5" x 1"	1/4"	\$18.54	\$19.34	\$20.15

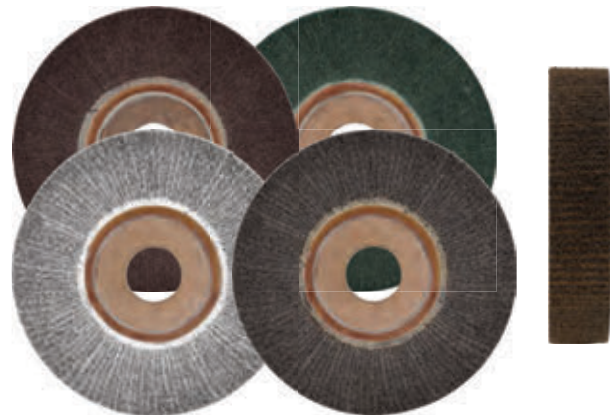

PRIMO® BLENDING AND CONVOLUTED WHEELS

Quality abrasive wheel made from silicon carbide. Ideal for blending, deburring, and pre-polishing.

Order #	Color	OD x Thickness	Inside Diameter	12+	6+	1+
10-8322	Gray	4" x 1"	1/4"	\$27.23	\$28.42	\$29.60
10-8322	Purple	4" x 1"	1/4"	\$27.23	\$28.42	\$29.60
10-8322	Green	4" x 1"	1/4"	\$27.23	\$28.42	\$29.60

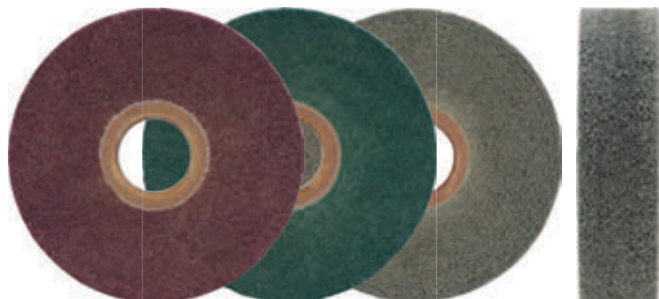



SUPER NEW-GLUE®

Super strength cyanoacrylate adhesive sets and cures rapidly at room temperature. New-Glue bonds rubber, metal, glass, and plastic. Dries clear and has an excellent resistance to chemicals and low temperatures. Made in the USA.

Order #	Size	Drying Time	12+	6+	1+
12-2120	3 g tube	20-30 seconds	\$1.66	\$1.80	\$2.00



VIGOR SUPER GLUE

Strong cyanoacrylate adhesive capable of bonding a combination of metals, plastic, rubber, ceramic, and glass. Sets and cures rapidly at room temperature. Requires no surface treatment. Bond is colorless and transparent.



Order #	Size	Drying Time	12+	6+	1+
12-2117	2 g tube	45-60 minutes	\$9.25	\$9.65	\$10.05
12-2118	32 g tube	10-20 minutes	\$8.79	\$9.17	\$9.55



G-S HYPO TUBE CEMENT

This precision applicator allows you to apply cement inside beads without creating a mess. Recommended for all illusion designs that use plastic, ceramic, glass, and metal beads. Dries clear — no mess! Will not bond fingers.

Order #	Size	Drying Time	12+	6+	1+
12-2050	½ oz tube	10-20 seconds	\$5.70	\$5.95	\$6.20



TWO-PART JEWELRY EPOXY

Used for making and repairing jewelry. Also works on metal, wood, glass, stones, crystal, and ceramic. Clear, non-shrink formula is resistant to most chemicals. Two-part epoxy sets in just five minutes and withstands temperatures up to 175°F. One fluid ounce total. Dries clear with a 2 year shelf life.

Order #	Size	Drying Time	12+	6+	1+
12-0451	2 – ½ oz tubes	5 minutes	\$3.27	\$3.41	\$3.55



SUPER GLUE QUICK FIX

1200 psi. Best product for general use. Works best on metal, china, glass, and plastic. Cures light yellow. One part hardener and one part resin.

Order #	Size	Drying Time	12+	6+	1+
12-2137	1 oz tubes	5 minutes	\$2.42	\$2.57	\$2.85

SUPER GLUE QUICK FIX

Original formula super glue bonds instantly. Precision applicator extender tip drops super glue into tight spots. Works best on clean non-porous surfaces including metal, rubber, and plastic.

Item	Order #	Size	Drying Time	12+	6+	1+
A	12-2114	2 g tube	10-20 seconds	\$1.80	\$2.03	\$2.25



A



B

SUPER GLUE GEL

Precision applicator best for continuous stream of glue. Self-piercing tube. Works best on metal, rubber, and plastic.

Item	Order #	Size	Drying Time	12+	6+	1+
B	12-2111	0.07 oz tube	10-20 seconds	\$2.07	\$2.16	\$2.25

FUTURE GLUE GEL

Bonds instantly, faster than other super glues. Works on multiple surfaces including oily or dirty surfaces. Selfpiercing tube. Works on porous and non-porous surfaces including metal, cardboard, and corkboard.

Item	Order #	Size	Drying Time	12+	6+	1+
C	12-2112	2 g tube	10-20 seconds	\$2.07	\$2.16	\$2.25



C



D

BONDINI EVERYTHING GEL

Fills gaps and cracks and penetrates through grease and oil to form a strong bond. Bonds rubber, stone, plastic, wood, metal, and tile.

Item	Order #	Size	Drying Time	12+	6+	1+
D	12-2113	4 g bottle	10-20 seconds	\$2.42	\$2.57	\$2.85

QUICK SETTING EPOXY

1200 psi. Bonds vertical surfaces and fills gaps. Cures cream color or can be tinted to desired color. Works best on rubber, carpet, wood, and plastic.

Item	Order #	Size	Drying Time	12+	6+	1+
E	12-2138	0.14 oz tubes	5 minutes	\$1.87	\$1.98	\$2.20



E

QUICK SETTING EPOXY

1200 psi. Best product for general use. Works best on metal, china, glass, and plastic. Cures light yellow.

Item	Order #	Size	Drying Time	12+	6+	1+
F	12-2136	1 oz tube	5 minutes	\$3.24	\$3.65	\$4.05



F





BEADALON® BEAD STRINGING GLUE

Great for use on Silk, Nymo, Nylon, Elasticity, Elonga, and other stringing materials. Beadalon Designers Bead Stringing Glue has a fine-tip applicator perfect for getting the glue exactly where you need it. No-clog cap keeps the applicator always ready.

Order #	Size	12+	6+	1+
12-2051	10 ml tube	\$3.95	\$4.18	\$4.65



VIGOR® SUPER GLUE

Exceptionally effective for stone and pearl settings. Strong ethyl adhesive bonds any combination of metal, plastic, rubber, ceramic, or glass. Sets in 45-60 seconds, and dries colorless and transparent.

Order #	Size	Drying Time	12+	6+	1+
12-2115	0.07 oz (2 g)	45-60 seconds	\$2.07	\$2.16	\$2.25



BEADFIX™ SUPERFAST ADHESIVE

This adhesive is ideal for adhering glass, stone, metal, plastic, wood, and most other types of beads. Quick adhesion; allow 24 hours dry time for maximum strength. Precision applicators available with 3 gram BeadFix.

Order #	Description	Size	12+	6+	1+
12-2121	Adhesive Glue	0.10 oz (3 g)	\$5.74	\$6.08	\$6.75



BEADALON® BEAD FIX GEL

This adhesive is ideal for adhering glass, stone, metal, plastic, wood, and most other types of beads. BeadFix is unaffected by cold and heat, and is water resistant. Quick setting, even on absorbent surfaces. When attaching End Caps to Memory Wire, allow 24 hours drying time for maximum strength.

Order #	Description	Size	12+	6+	1+
12-2056	Adhesive Gel	0.43 oz (3 g)	\$5.74	\$6.08	\$6.75



GRIFFITH ACETONE

This quick-drying solvent dissolves most lacquers and cements.

Order #	Description	Size	12+	6+	1+
54-8000	Acetone Solvent	8 oz bottle	\$6.72	\$7.01	\$7.30

TWO-PART JEWELRY EPOXY

A high-grade clear synthetic rubber adhesive with superior adhesion characteristics that sets in 10 minutes. Works on all woods, metals, fiberglass, glass, leather, and reinforced plastics. May be used on high wear surfaces.

Order #	Size	12+	6+	1+
12-2135	3.7 oz tube	\$5.23	\$5.54	\$6.15



DEVCON® EPOXY

Devcon® epoxy adhesive cures and joins materials together by a chemical reaction between the resin and hardener. This reaction results in a high strength bond that is resistant to most chemicals. Use epoxy adhesive for household, industrial, crafts, or for any job that requires a high-strength, high-quality bond. Works on metal, wood, concrete, glass, ceramics, china, and much more. Sets in five minutes and dries clear with strength up to 1,500 lbs

Item	Order #	Size	Drying Time	12+	6+	1+
A	12-2131	2- ½ oz tubes	5 minutes	\$3.83	\$4.05	\$4.50
B	12-2132	2- ½ oz tubes	10-20 minutes	\$4.72	\$5.00	\$5.55



DEVCON® EPOXY 220, LIGHT AMBER

C. Drying Time: 12 hours (20 minutes with heat)

DEVCON® EPOXY 330, WATER CLEAR

D. Excellent for attaching end caps to leather cord, the assembly of stones to metal findings and mending broken glass and china. Hardens in one hour (approximately) at room temperature and 10 minutes under heat lamp at 200°F. Ideal where clarity is important. Refractive index is 1.3025, tensile strength neat 9,000 pounds with viscosity at 1,200 CPS. Drying Time: 1 hour (10 minutes with heat)

Item	Order #	Description	Size	12+	6+	1+
C	26-6009	Epoxy 220	2- ½ oz tubes	\$5.06	\$5.36	\$5.95
D	26-6010	Epoxy 330	2- ½ oz tubes	\$5.06	\$5.36	\$5.95



ATTACK GLUE-DISSOLVING COMPOUND

Dissolves cured epoxy and polyester resins. Cleans cured resins from metal, stone, glass, wood, undrilled pearls, quartz, coral, and many other materials. Do not use with plastic, amber, or amelite.

Order #	Description	Size	12+	6+	1+
38-3250	Dissolving Compound	8 oz can	\$9.38	\$9.79	\$10.20



Adhesives

MINIGRIP RED LINE BAGS

Premium zipper easily snaps open—even with one hand—and zips securely shut. Superior clarity that you can see. Red Line bags are packaged in convenient dispenser bag packaging. Remove a bag at a time through the mid-package opening or...through the zipper at the top! Manufactured with 100% FDA-approved virgin LDPE and LLDPE resins. Reinforced zipper and side seams to keep bags from splitting when opened or filled. Volume pricing is available by the box of 1,000.



Order # 90-0000
 Material Plastic
 Thickness 2 mil
 Sold in Bags of 100

	2" x 2"	2" x 3"	3" x 3"	3" x 4"	3" x 5"	4 x 4"
50+	\$1.25	\$1.25	\$1.63	\$1.70	\$1.78	\$1.95
10+	\$1.38	\$1.38	\$1.79	\$1.87	\$1.95	\$2.15
1+	\$2.50	\$2.50	\$3.25	\$3.40	\$3.55	\$3.90

	4" x 6"	4" x 8"	5" x 7"	6" x 8"	8" x 10"	10 x 12"
50+	\$2.20	\$4.17	\$3.10	\$4.62	\$5.81	\$8.15
10+	\$2.42	\$4.46	\$3.41	\$4.95	\$6.23	\$8.74
1+	\$4.40	\$5.95	\$6.20	\$6.60	\$8.30	\$11.65

Order # 90-0200
 Material Plastic
 Thickness 4 mil
 Sold in Bags of 100

	2½" x 3"	3" x 4"	3" x 5"	4" x 6"	6" x 6"	6 x 8"
50+	\$2.91	\$3.50	\$4.10	\$5.29	\$6.62	\$7.74
10+	\$3.11	\$3.75	\$4.39	\$5.66	\$7.09	\$8.29
1+	\$4.15	\$5.00	\$5.85	\$7.55	\$9.45	\$11.05

	6" x 9"	8" x 10"	10" x 10"	10" x 13"
50+	\$9.38	\$12.32	\$15.47	\$22.68
10+	\$10.05	\$13.20	\$16.58	\$24.30
1+	\$13.40	\$17.60	\$22.10	\$32.40

MINIGRIP RED LINE WHITE BLOCK BAGS

Premium zipper easily snaps open—even with one hand—and zips securely shut. Superior clarity that you can see. Red Line bags are packaged in convenient dispenser bag packaging. Remove a bag at a time through the mid-package opening or...through the zipper at the top! Manufactured with 100% FDA-approved virgin LDPE and LLDPE resins. Reinforced zipper and side seams to keep bags from splitting when opened or filled. Volume pricing is available by the box of 1,000.



Order # 90-0100
 Material Plastic
 Thickness 2 mil
 Sold in Bags of 100

	2" x 3"	3" x 4"	3" x 5"	4" x 6"	5" x 8"	6" x 9"	8" x 10"	9" x 12"
50+	\$1.65	\$1.78	\$1.90	\$2.65	\$4.87	\$5.78	\$10.19	\$10.54
10+	\$1.82	\$1.95	\$2.09	\$2.92	\$5.21	\$6.19	\$10.91	\$11.29
1+	\$3.30	\$3.55	\$3.80	\$5.30	\$6.95	\$8.25	\$14.55	\$15.05

Order # 90-0300
 Material Plastic
 Thickness 4 mil
 Sold in Bags of 100

	4" x 6"	6" x 9"
50+	\$6.65	\$10.75
10+	\$7.13	\$11.51
1+	\$9.50	\$15.35

MINIGRIP GREEN LINE BIODEGRADABLE BAGS

Ever wonder what happens to that poly bag when you throw it away? It will sit in a landfill for years before it even starts to biodegrade, if it does at all. With new Minigrip Green Line™ bags, you no longer have to worry. Minigrip technology contains an innovative bio-resin additive found to be biodegradable (ASTM D5511), thus drastically reducing the plastic's landfill life. Every part of the bag is biodegradable. Same great performance of a Red Line™ Bag, but biodegradable. Made of low-density polyethylene (LDPE).

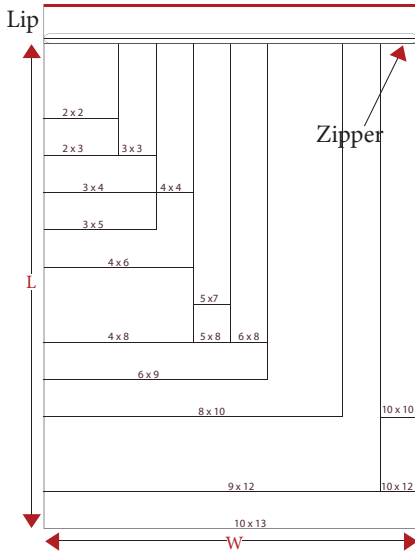

Order # 90-1000
 Material Plastic
 Thickness 2 mil
 Sold in Bags of 100

	2" x 2"	2" x 3"	3" x 4"	4" x 6"	5" x 7"	6" x 9"	9" x 12"
50+	\$1.25	\$1.48	\$2.00	\$2.60	\$3.65	\$5.20	\$8.50
10+	\$1.38	\$1.62	\$2.20	\$2.86	\$4.01	\$5.72	\$9.35
1+	\$2.50	\$2.95	\$4.00	\$5.20	\$7.30	\$10.40	\$17.00



Bags are measured width by length. Width is the outside dimension, Length is measured from the bottom of the zipper to the bottom of the bag. Due to reinforced side seals, bag openings are approximately 1/2" less than their listed width.

Width x Length resealable bags are measured without the zipper included.

CORROSION INTERCEPT CLEAR POLY ZIP-LOCK BAGS

Corrosion Intercept® clear poly zip-lock bags provide effective tarnish protection for metals. When the copper color turns black, it's time to change the intercept package. Protects items for up to 3 years. (sold in packs of 20)



Order #	W x L	12+	6+	1+
61-1331	2" x 3"	\$4.04	\$4.28	\$4.75
61-1331	2" x 3" (pack of 1,000)	\$126.27	\$133.70	\$148.55
61-1332	4" x 4"	\$5.10	\$5.40	\$6.00
61-1333	4" x 6"	\$5.31	\$5.63	\$6.25
61-1334	6" x 8"	\$6.76	\$7.16	\$7.95
61-1335	4" x 4" Dual Compartment	\$5.40	\$5.72	\$6.35
61-1336	6" x 6" Dual Compartment	\$7.23	\$7.65	\$8.50



STATIC INTERCEPT NON-ABRASIVE ANTI-TARNISH STRIPS/TABS

The same technology used by NASA, the Guggenheim Museum and jewelry manufacturers worldwide.

- Provides protection from tarnish for up to 12 months
- Does not leave deposits on items it protects
- Nontoxic, non-abrasive, and will not scratch or harm metals or gemstones
- Before placing item in pouch, be sure item is clean, dry, and free of fingerprints and deposits

Order #	Description	W x L	12+	6+	1+
11-0651	Strip (20 pack)	2" x 7"	\$3.61	\$3.92	\$4.35
11-0652	Tab (50 pack)	1" x 1"	\$2.91	\$3.15	\$3.50



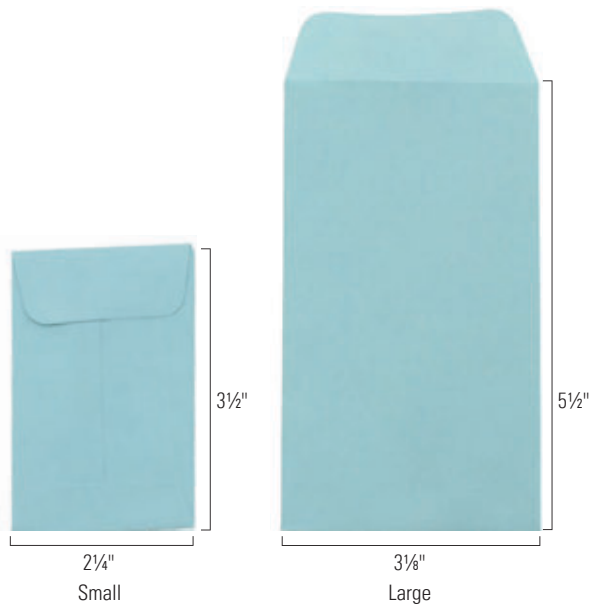

BLANK JOB ENVELOPES

Handy envelopes to identify your work and help prevent misdirected orders. Gummed flaps for easy closing and reopening. Available in two sizes and five colors. Sold in packs of 500.



Order #	Description	W x L	12+	6+	1+
61-1595	#1 Kraft	2 1/4" x 3 1/2"	\$14.77	\$15.28	\$16.98
61-1596	#1 White	2 1/4" x 3 1/2"	\$14.77	\$15.28	\$16.98
61-1597	#1 Canary	2 1/4" x 3 1/2"	\$14.77	\$15.28	\$16.98
61-1598	#1 Light Green	2 1/4" x 3 1/2"	\$14.77	\$15.28	\$16.98
61-1599	#1 Light Blue	2 1/4" x 3 1/2"	\$14.77	\$15.28	\$16.98
61-1600	#5 Kraft	3 1/8" x 5 1/2"	\$19.04	\$19.70	\$21.89
61-1601	#5 White	3 1/8" x 5 1/2"	\$19.04	\$19.70	\$21.89
61-1602	#5 Canary	3 1/8" x 5 1/2"	\$19.04	\$19.70	\$21.89
61-1603	#5 Light Green	3 1/8" x 5 1/2"	\$19.04	\$19.70	\$21.89
61-1604	#5 Light Blue	3 1/8" x 5 1/2"	\$19.04	\$19.70	\$21.89

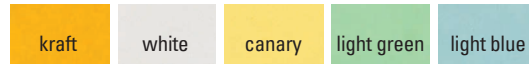

Appraisal Form

APPRAISAL FORMS

These repair order forms highlight specific areas to indicate issues for jewelry or watch repair. The triple form allows for individual copies for record keeping and customers.

Order #	Description	W x L	12+	6+	1+
61-1630	3-Part Jewelry Repair Forms (Box of 500)	4 1/2" x 6 1/2"	\$60.03	\$62.10	\$69.00
61-1635	3-Part Watch Repair Forms (Box of 500)	4 1/2" x 6 1/2"	\$60.03	\$62.10	\$69.00
61-1660	Zip Bag with Pouch (Box of 100)	5" x 6 1/2"	\$89.72	\$93.79	\$101.95
61-1655	Appraisal Form	8 1/2" x 11"	\$21.71	\$22.46	\$24.95



Zip Bag with Pouch (Box of 100)

Jewelry Form Close-Up

Watch Form Close-Up

3-Part Jewelry Repair Forms (Box of 500)

TRIPLE-DUTY REPAIR ENVELOPES

Each numbered envelope has two detachable stubs with corresponding numbers; one for the customer and one for filing. Printed on standard kraft paper. Measures 3 1/8" x 5 3/4". Sold in packs of 1,000.



Order #	Description	Envelope #	12+	6+	1+
61-1510	Repair Envelope	1-1000	\$36.98	\$38.25	\$42.50
61-1520	Repair Envelope	1001-2000	\$36.98	\$38.25	\$42.50
61-1530	Repair Envelope	2001-3000	\$36.98	\$38.25	\$42.50
61-1540	Repair Envelope	2001-4000	\$36.98	\$38.25	\$42.50
61-1550	Repair Envelope	2001-5000	\$36.98	\$38.25	\$42.50
61-1555	Repair Envelope	5001-6000	\$36.98	\$38.25	\$42.50
61-1556	Repair Envelope	6001-7000	\$36.98	\$38.25	\$42.50
61-1557	Repair Envelope	7001-8000	\$36.98	\$38.25	\$42.50
61-1558	Repair Envelope	8001-9000	\$36.98	\$38.25	\$42.50
61-1559	Repair Envelope	9001-9999	\$36.98	\$38.25	\$42.50

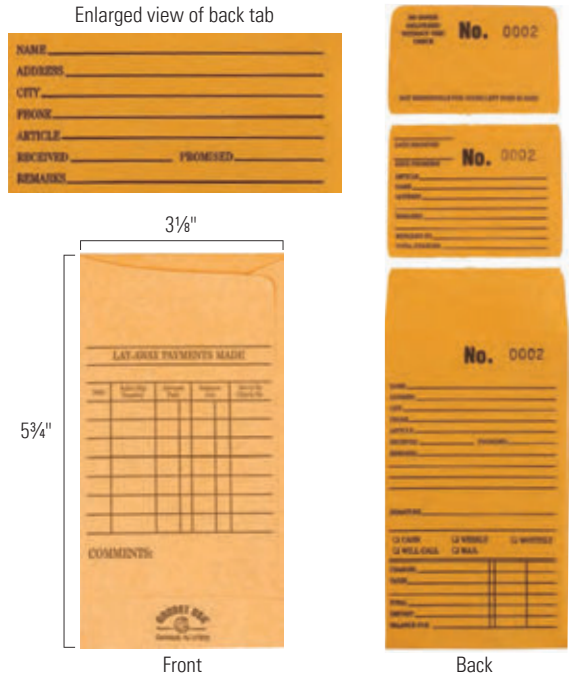

ACRYLIC ENVELOPE ORGANIZER AND DIVIDERS

Keep your repair orders neat and arranged with this handy repair envelope organizer. Made of clear, sturdy, acrylic, this organizer will fit conveniently on most work surfaces for easy storage and retrieval. Repair envelopes (61-1510 shown with A) not included.

Item Order #	Description	W x L x H	12+	6+	1+
A 61-1560	Acrylic Envelope Organizer	3 1/2" x 11" x 3 1/2"	\$18.35	\$18.75	\$19.95
B 61-1640	Repair Form Dividers	9" x 4"	\$82.18	\$83.89	\$85.60

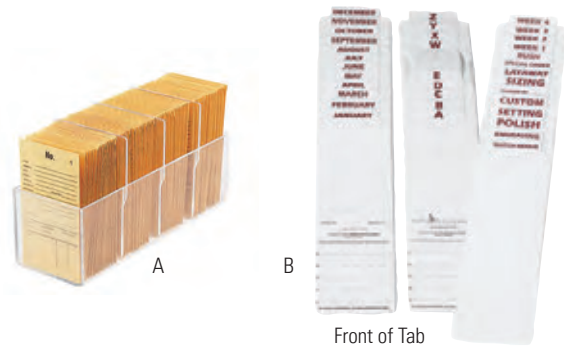

THANK YOU ENVELOPES

Thank you envelopes. Sold in packs of 250.



Order #	Description	W x L	12+	6+	1+
61-1645	Blue	4" x 6 3/8"	\$30.10	\$31.14	\$34.60
61-1648	Black	4" x 6 3/8"	\$30.10	\$31.14	\$34.60
61-1647	Green	4" x 6 3/8"	\$30.10	\$31.14	\$34.60
61-1646	Burgundy	4" x 6 3/8"	\$30.10	\$31.14	\$34.60



JEWELRY REPAIR ENVELOPES

These repair order forms highlight specific areas to indicate issues for jewelry or watch repair. The triple form allows for individual copies for record keeping and customers.



Order #	Description	W x L	12+	6+	1+
61-1700	Repair Envelopes (Box of 500)	5 1/2" x 3 1/8"	\$22.60	\$23.38	\$25.98

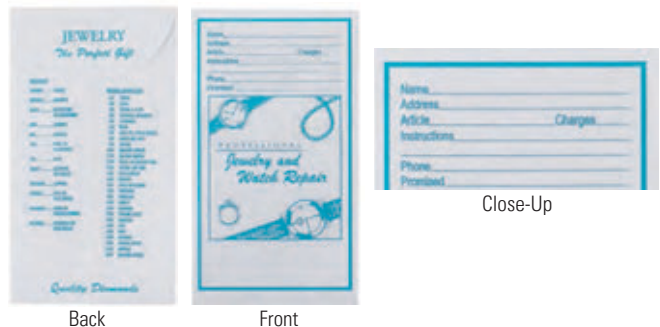

Bags and Envelopes

Energizer

- Buy them in bulk or buy them as singles
- Energizer®, a name you can trust for performance
- Alkaline, rechargeable, watch, hearing aid, testers, kits
- Available for next day delivery
- Huge profit potential for jewelers

Build battery sales and profits with our wide range of battery options. Visit Stuller.com to see our complete line of batteries and accessories. Order online or call 800-877-7777.



ENERGIZER WATCH BATTERY STARTER KITS

Build your watch battery replacement sales and profits with our Energizer® Watch Battery Deluxe Starter Kit. These kits contain assorted watch batteries that cover 97% of the replacement market sales, plus other useful tools to make your watch battery replacement business a profit center.

- 60 Drawer Cabinet
- Watch Battery Analyzer
- Cross Reference Guide
- Battery Size Chart
- Store Counter Sign
- Training Booklet
- Watch Tool Kit

Deluxe Kit contains:

- Battery Types Included (200):
- 20 each: 377SP, 362SP, 379SP
- 5 each: 371, 376, 370, 392, 397, 337, 394, 315, 303, 384, 391, 395, 357, 321, 317, 319, 362, 399, 373, 396, 389, 344, 390, ECR1216, ECR2025, ECR2016, ECR2032, ECR1025

Basic Kit contains:

- Battery Types Included (130):
- 20 each: 377SP, 364SP
- 5 each: 379, 371, 376, 395, 357, 321, 317, 370, 319, 392, 362, 397, 399, 337, 373, ECR2016, ECR1216, ECR2032



Item	Order #	Description	1+
A	EBAT:DELUXE:T	Deluxe Watch Battery Kit	\$199.00
B	EBATBASIC	Basic Watch Battery Kit	\$119.95

Energizer. ZEROMERCURY®



ENERGIZER-LITHIUM BATTERIES (INDIVIDUAL)

Order #	100+	25+	1+
EBAT 1025	\$0.83	\$0.99	\$1.18
EBAT 1225	\$0.64	\$0.76	\$0.91
EBAT 1220	\$0.75	\$0.94	\$1.25
EBAT 1216	\$0.80	\$1.00	\$1.33
EBAT 1620	\$0.71	\$0.86	\$1.02
EBAT 1632	\$0.71	\$0.89	\$1.18
EBAT 1616	\$0.56	\$0.70	\$0.93
EBAT 2025	\$0.64	\$0.77	\$0.92
EBAT 2016	\$0.64	\$0.77	\$0.92
EBAT 2032	\$0.65	\$0.78	\$0.93
EBAT 2012	\$0.73	\$0.92	\$1.22
EBAT 2450	\$0.99	\$1.19	\$1.42
EBAT 2430	\$0.83	\$1.00	\$1.19

ENERGIZER-SILVER OXIDE BATTERIES (INDIVIDUAL)

Order #	100+	25+	1+
EBAT 364-363	\$0.00	\$0.00	\$0.39
EBAT 377-376	\$0.00	\$0.00	\$0.44
EBAT 379	\$0.00	\$0.00	\$0.52
EBAT 317	\$0.70	\$0.88	\$1.17
EBAT 319	\$0.52	\$0.62	\$0.74
EBAT 319	\$0.57	\$0.69	\$0.82
EBAT 379	\$0.50	\$0.60	\$0.72
EBAT 377-376	\$0.34	\$0.40	\$0.48
EBAT 321	\$0.53	\$0.64	\$0.76
EBAT 364-363	\$0.29	\$0.35	\$0.42
EBAT 362-361	\$0.47	\$0.56	\$0.67
EBAT 341	\$1.23	\$1.48	\$1.76
EBAT 397-396	\$0.57	\$0.69	\$0.82
EBAT 315	\$0.76	\$0.91	\$1.08
EBAT 393-309	\$0.95	\$1.14	\$1.36
EBAT 373	\$0.71	\$0.85	\$1.01
EBAT 371-370	\$0.54	\$0.65	\$0.77
EBAT 395-399	\$0.57	\$0.69	\$0.82
EBAT 394-380	\$0.78	\$0.94	\$1.12
EBAT 386-301	\$1.13	\$1.36	\$1.62

OTHER BRANDS

Order #	Brand	100+	25+	1+
EBAT 2354	Panasonic	\$2.30	\$2.76	\$3.28
EBAT 2412	Panasonic	\$4.58	\$5.49	\$6.54
EBAT 1612	Panasonic	\$3.51	\$4.22	\$5.02
EBAT 2320	Renata	\$0.81	\$0.97	\$1.15

WATCH BATTERIES (SPACE PACKS)



Order #	100+	25+	1+
EBAT 341	\$19.44	\$23.33	\$27.77
EBAT 317	\$10.78	\$12.94	\$15.40
EBAT 379	\$8.62	\$10.34	\$12.31
EBAT 319	\$9.25	\$11.10	\$13.21
EBAT 377-376	\$6.38	\$7.65	\$9.11
EBAT 321	\$8.51	\$10.21	\$12.16
EBAT 364-363	\$5.67	\$6.80	\$8.10
EBAT 397-396	\$9.04	\$10.84	\$12.91
EBAT 362-361	\$7.54	\$9.05	\$10.77
EBAT 315	\$12.67	\$15.20	\$18.10
EBAT 395-399	\$9.38	\$11.26	\$13.40
EBAT 394-380	\$11.74	\$14.09	\$16.77
EBAT 373	\$11.74	\$14.09	\$16.77
EBAT 371-370	\$8.41	\$10.09	\$12.01





EMERGING POWER BATTERIES

Order #	100+	25+	1+
EBAT 309	\$6.27	\$6.27	\$6.27
EBAT 315	\$3.75	\$3.75	\$3.75
EBAT 319	\$3.17	\$3.17	\$3.17
EBAT 321	\$2.59	\$2.59	\$2.59
EBAT 329	\$6.27	\$6.27	\$6.27
EBAT 337	\$6.27	\$6.27	\$6.27
EBAT 339	\$6.27	\$6.27	\$6.27
EBAT 341	\$6.27	\$6.27	\$6.27
EBAT 344-350	\$6.27	\$6.27	\$6.27
EBAT 346	\$6.27	\$6.27	\$6.27
EBAT 357-303	\$5.30	\$5.30	\$5.30
EBAT 362-361	\$2.07	\$2.07	\$2.07
EBAT 364-363	\$1.41	\$1.41	\$1.41
EBAT 365-366	\$6.27	\$6.27	\$6.27
EBAT 371-370	\$2.15	\$2.15	\$2.15
EBAT 373	\$2.86	\$2.86	\$2.86
EBAT 377-376	\$1.48	\$1.48	\$1.48
EBAT 379	\$1.73	\$1.73	\$1.73
EBAT 386-301	\$5.82	\$5.82	\$5.82
EBAT 387	\$5.69	\$5.69	\$5.69
EBAT 390-389	\$2.98	\$2.98	\$2.98
EBAT 391-381	\$6.27	\$6.27	\$6.27
EBAT 392-384	\$2.46	\$2.46	\$2.46
EBAT 394-380	\$3.68	\$3.68	\$3.68
EBAT 395-399	\$2.50	\$2.50	\$2.50
EBAT 397-396	\$2.52	\$2.52	\$2.52



EMERGING POWER-LITHIUM WATCH BATTERIES

Order #	100+	25+	1+
EBAT 1025	\$1.52	\$1.52	\$1.52
EBAT 1225	\$1.64	\$1.64	\$1.64
EBAT 1220	\$1.57	\$1.57	\$1.57
EBAT 1216	\$1.43	\$1.43	\$1.43
EBAT 1620	\$1.49	\$1.49	\$1.49
EBAT 1632	\$2.51	\$2.51	\$2.51
EBAT 1616	\$1.22	\$1.22	\$1.22
EBAT 2032	\$0.87	\$0.87	\$0.87
EBAT 2025	\$0.88	\$0.88	\$0.88
EBAT 2016	\$0.87	\$0.87	\$0.87
EBAT 2450	\$2.77	\$2.77	\$2.77
EBAT 2430	\$2.25	\$2.25	\$2.25

RENATA DELUX WATCH BATTERY STARTER KIT

This deluxe assortment contains everything needed to get started, including the perfect mix of 225 assorted popular batteries-46 types covering 99% of sales, Renata's designer 60-drawer organizer display cabinet, two watch case openers, small Phillips and flat head screwdrivers, battery size selector, plastic tweezers, cross reference guides, inventory control form, watch battery tester, case vice table clamp, scratch brush contact case cleaner, spring bar tool and assorted spring bars, rubber gasket assortment, Renata official traffic Poster and Renata Watch Battery Basics instructional DVD.

Item	Order #	Description	1+
A	RBAT:DELUXE:T	Renata Deluxe Watch Battery Starter Kit	\$224.95
	RBAT:BASIC	Renata Basic Watch Battery Kit	\$159.95



RENATA BATTERY SIZE CHECKER

This handy hard plastic tool is the world's easiest device for cross-referencing button and coin cell watch batteries. Start with the small holes and work your way around until you find a hole that fits. Type numbers marked next to the holes correspond to the cell size. The device indicates which option to use to power simple analogs or high drain applications incorporating back lights and alarms.

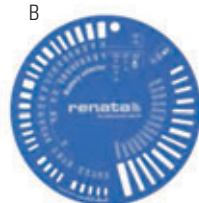

- Each single blister can be torn away from the compact strip of 10 cells.
- Renata's type number, corresponding Japanese number and best before/use by date are printed on each individual blister.
- Black arrow indicates easy-opening tab located in one corner of the blister.

Item	Order #	Description	1+
B	RBAT101	Renata Battery Size Checker	\$2.95

RENATA BATTERIES

RENATA's comprehensive assortment of over 40 different watch battery types, mostly of the silver oxide 1.55 V system, offers a suitable power source for any electronic device requiring an ultra-compact, long lasting, low voltage power source. Thanks to its close association with Swiss watch industry, RENATA has first-hand knowledge of what a high quality watch battery must stand for, an optimized volume/capacity ratio, dimensional precision and stability, high capacity retention on storage (low self-discharge), excellent reliability thanks to a uniformly high quality level, state of the art leakproofness thanks to a sophisticated sealing process, and constant availability



Order #	100+	25+	1+
EBAT 1025	\$9.09	\$10.90	\$12.98
EBAT 1216	\$10.24	\$12.29	\$14.63
EBAT 1220	\$9.63	\$11.55	\$13.75
EBAT 1225	\$7.01	\$8.41	\$10.01
EBAT 1616	\$7.16	\$8.59	\$10.23
EBAT 1620	\$7.85	\$9.42	\$11.22
EBAT 1632	\$9.09	\$10.90	\$12.98
EBAT 2016	\$7.08	\$8.50	\$10.12
EBAT 2025	\$7.08	\$8.50	\$10.12
EBAT 2032	\$7.16	\$8.59	\$10.23
EBAT 2320	\$8.20	\$9.84	\$11.71
EBAT 2325	\$8.97	\$10.76	\$12.81
EBAT 2430	\$9.16	\$11.00	\$13.09
EBAT 2450N	\$10.93	\$13.12	\$15.62
EBAT 301	\$12.47	\$14.97	\$17.82
EBAT 303	\$12.47	\$14.97	\$17.82
EBAT 309	\$10.47	\$12.57	\$14.96
EBAT 315	\$8.32	\$9.98	\$11.88
EBAT 317	\$9.01	\$10.81	\$12.87

Order #	100+	25+	1+
EBAT 319	\$6.31	\$7.58	\$9.02
EBAT 321	\$5.85	\$7.02	\$8.36
EBAT 329	\$9.16	\$11.00	\$13.09
EBAT 335	\$11.70	\$14.04	\$16.72
EBAT 337	\$18.40	\$22.08	\$26.29
EBAT 339	\$11.21	\$13.46	\$16.02
EBAT 341	\$13.55	\$16.26	\$19.36
EBAT 344	\$15.48	\$18.57	\$22.11
EBAT 346	\$14.01	\$16.82	\$20.02
EBAT 350	\$15.48	\$18.57	\$22.11
EBAT 357	\$12.47	\$14.97	\$17.82
EBAT 361	\$5.16	\$6.19	\$7.37
EBAT 362	\$5.16	\$6.19	\$7.37
EBAT 364	\$3.70	\$4.44	\$5.28
EBAT 365	\$11.70	\$14.04	\$16.72
EBAT 366	\$11.70	\$14.04	\$16.72
EBAT 370	\$5.93	\$7.11	\$8.47
EBAT 371	\$5.93	\$7.11	\$8.47
EBAT 373	\$7.78	\$9.33	\$11.11

Order #	100+	25+	1+
EBAT 376	\$4.70	\$5.64	\$6.71
EBAT 377	\$4.70	\$5.64	\$6.71
EBAT 379	\$5.54	\$6.65	\$7.92
EBAT 380	\$8.62	\$10.35	\$12.32
EBAT 381	\$7.25	\$8.69	\$10.35
EBAT 384	\$4.77	\$5.73	\$6.82
EBAT 386	\$12.47	\$14.97	\$17.82
EBAT 387S	\$13.86	\$16.63	\$19.80
EBAT 389	\$7.08	\$8.50	\$10.12
EBAT 390	\$7.08	\$8.50	\$10.12
EBAT 391	\$7.39	\$8.86	\$10.55
EBAT 392	\$4.77	\$5.73	\$6.82
EBAT 393	\$10.47	\$12.57	\$14.96
EBAT 394	\$8.62	\$10.35	\$12.32
EBAT 395	\$6.31	\$7.58	\$9.02
EBAT 396	\$6.31	\$7.58	\$9.02
EBAT 397	\$6.31	\$7.58	\$9.02
EBAT 399	\$6.31	\$7.58	\$9.02
EBAT 2320	\$0.81	\$0.97	\$1.15

Energizer



ENERGIZER WATCH BATTERY PAD

This durable watch battery pad is an excellent work surface for your battery changing station. It features a boldly printed battery size cross reference chart that covers every conceivable contemporary battery size.

Order #	Description	12+	6+	1+
EBATPAD	Battery Coin Cross-Reference Pad	\$8.97	\$9.49	\$10.55



ENERGIZER MAX (BLISTER-PACKED)

- Long lasting, dependable power for your everyday devices
- Available in AA, AAA, AAAA, C, D, 9 volt
- Estimated shelf life - 7 years

Item	Order #	Battery Size	Per Pack	12+	6+	1+
A	EBATAA	AA	Pack of 4	\$4.60	\$4.80	\$5.00
B	EBATAAA	AAA	Pack of 4	\$5.15	\$5.38	\$5.60
C	EBATAAAA	AAAA	Pack of 2	\$3.31	\$3.46	\$3.60
D	EBATC	C	Pack of 2	\$4.83	\$5.04	\$5.25
E	EBATD	D	Pack of 2	\$4.83	\$5.04	\$5.25
F	EBAT9V	9V	Pack of 1	\$4.83	\$5.04	\$5.25



BATTERY SIZE CHECKER

Conveniently determine battery size with this easy-to-use plastic battery size checker. Just slip the battery into the various slots to determine size.

Order #	Description	12+	6+	1+
EBAT101	Battery Size Checker	\$1.43	\$1.49	\$1.55



EVEREADY ALKALINE BATTERIES (BLISTER-PACKED)

- The Eveready® brand name has been part of powering people's lives for over 160 years
- These batteries are long lasting in low to moderate drain devices
- Estimated shelf life - 5 years

Item	Order #	Battery Size	Per Pack	12+	6+	1+
G	EBATAA	AA	Pack of 4	\$3.40	\$3.55	\$3.70
H	EBATAAA	AAA	Pack of 4	\$3.40	\$3.55	\$3.70
J	EBATC	C	Pack of 2	\$3.50	\$3.65	\$3.80
K	EBATD	D	Pack of 2	\$3.59	\$3.74	\$3.90
L	EBAT9V	9V	Pack of 1	\$3.31	\$3.46	\$3.60



ENERGIZER ADVANCED LITHIUM

Lithium battery technology maximizes your gear's performance and keeps you going non-stop.

- Last up to 4X longer in digital cameras (versus Energizer® Max)
- Last 20 hours longer in wireless gaming accessories.
- Last up to 30% longer in personal audio devices (versus Energizer® Max)
- Weighs 1/3 less than standard alkaline.
- Available in AA, AAA, 9V
- Estimated shelf life - 10 years
- Leak resistant construction



A



B

Item	Order #	Battery Size	Per Pack	12+	6+	1+
A	EBATAA	AA	Pack of 4	\$8.83	\$9.22	\$9.60
B	EBATAAA	AAA	Pack of 4	\$8.83	\$9.22	\$9.60

ENERGIZER ULTIMATE LITHIUM BATTERIES

For the countless electronic gadgets that you can't live without. Get the best lithium battery technology that's proven to be the world's longest lasting AA and AAA batteries in high-tech devices. Other things you should know:

- Last up to 8X longer in digital cameras (versus Energizer® Max AA only, results vary by camera)
- Weigh 1/3 less than standard alkaline batteries
- Performs in extreme temperatures from -40°F to 140°F
- Leak resistant construction
- 15-year storage life



C



D



E

Item	Order #	Battery Size	Per Pack	12+	6+	1+
C	EBATAA	AA	Pack of 8	\$16.51	\$17.23	\$17.95
D	EBATAA	AA	Pack of 2	\$9.15	\$9.55	\$9.95
E	EBATAAA	AAA	Pack of 4	\$9.15	\$9.55	\$9.95

ENERGIZER HEARING AID BATTERIES

- World's only hearing aid battery dispenser
- Battery goes straight from dispenser to hearing aid
- Dispenser protects batteries from dust and dirt
- Available in sizes 10, 13, 312, 675, -1.4V



Order #	Description	Battery #	Per Pack	12+	6+	1+
EBATHA	EZ Turn & Lock	#10	Pack of 8	\$9.15	\$9.55	\$9.95
EBATHA	EZ Turn & Lock	#10	Pack of 16	\$14.67	\$15.31	\$15.95
EBATHA	EZ Turn & Lock	#13	Pack of 16	\$14.67	\$15.31	\$15.95
EBATHA	EZ Turn & Lock	#13	Pack of 8	\$9.15	\$9.55	\$9.95
EBATHA	EZ Turn & Lock	#312	Pack of 8	\$9.15	\$9.55	\$9.95
EBATHA	EZ Turn & Lock	#312	Pack of 16	\$14.67	\$15.31	\$15.95
EBATHA	EZ Turn & Lock	#675	Pack of 8	\$9.15	\$9.55	\$9.95
EBATHA	EZ Turn & Lock	#675	Pack of 4	\$4.55	\$4.75	\$4.95

ENERGIZER SPECIAL APPLICATION BATTERIES

- These lithium batteries have high-energy density and a long-life power source
- Used in photography devices, calculators, memory backup, pocket pages, and watches



Order #	Description	Volts	Per Pack	12+	6+	1+
EBAT1.5V	N	1.5V	Pack of 2	\$2.53	\$2.64	\$2.75
EBAT12V	A23	12V	Pack of 2	\$2.67	\$2.78	\$2.90

Energizer



A B C



D E



F

G



H

ENERGIZER E² RECHARGEABLE

Features and Benefits:

- Packed with four AA 2500 MAH cells
- Energizer's highest capacity cells
- Charges both AA and AAA NiMH cells in 8½ hours
- Compact charger ideal for camera and travel bags
- Package fits on standard pegs

Item	Order #	Description	12+	6+	1+
A	EBATAA	Rechargeable Batteries, AA (2-pack)	\$5.84	\$6.10	\$6.35
B	EBATAAA	Rechargeable Batteries, AAA (2-pack)	\$6.99	\$7.30	\$7.60
C	EBATC	Rechargeable Batteries, C (2-pack)	\$9.20	\$9.60	\$10.00
D	EBATD	Rechargeable Batteries, D (2-pack)	\$9.20	\$9.60	\$10.00
E	EBAT9V	Rechargeable Batteries, 9V (1-pack)	\$9.20	\$9.60	\$10.00

ENERGIZER® CHARGERS

F. Smart Battery Charger

Countdown timer shows how long until batteries are charged. Battery fuel gauge shows charge status. Bad battery alert detects, alerts, and shuts off charging when a non-NiMH or old NiMH battery is inserted. Large visual display can be viewed from across the room. Charges two or four AA or AAA NiMH rechargeable batteries.

G. 15-Minute Battery Charger

Charges 1-4 AA or AAA NiMH rechargeable batteries. Charge in your car with the included car adapter or at home with the wall adapter. Easy-to-read charge status indicator light. Energy Star certified.

H. Family Charger

- Super safe-will only begin charging when closed
- Easy-to-read charge status indicator
- Charges up to eight AA, eight AAA, four C, four D, or two 9V rechargeable batteries

Item	Order #	Description	12+	6+	1+
F	EBATCHARGER	Smart Charger	\$19.27	\$20.11	\$20.95
G	EBATCHARGER	15-Minute Charger	\$38.00	\$39.65	\$41.30
H	EBATCHARGER	Family Charger	\$30.31	\$31.63	\$32.95



Energizer**ENERGIZER® METAL KEY CHAIN LIGHT**

Bright Nichia LED delivers. Momentary push-button switch for extended 30-hour run time. Spring clip key chain. Two Energizer® CR2032 lithium coin cell batteries included. Durable cast metal body.

Item	Order #	Description	Lumens	12+	6+	1+
A	80-0003	1 Bulb LED Light	14	\$7.18	\$7.61	\$8.45



A

**ENERGIZER® LIGHT**

Bright 1 Watt LED. Knurled grip. 7-hour run time with AA lithium or 3½ hours with alkaline. Durable machine with high strength aluminum case. Regulatory circuitry for stable light output. Weatherproof push-button tail switch. Packed with Energizer® Ultimate Lithium AA batteries.

Item	Order #	Description	Lumens	12+	6+	1+
B	80-0001	Tactical Metal Light	85	\$20.70	\$21.92	\$24.35



B

**ENERGIZER® FLASHLIGHT**

Non-slip rubber textured handle with built-in stand for hands-free use. Large push-button switch for use with gloves. LED technology. Packed with long-lasting AAA Energizer® batteries.

Item	Order #	Description	Lumens	12+	6+	1+
C	80-0002	Large 2 Bulb LED Light	11	\$9.86	\$10.44	\$11.60



C

DELUXE BATTERY TOOL KIT (EVEREADY® TOOL KIT)

Contains the tools you need to change a battery in a convenient, faux-leather pouch. Has a zipper and elastic bands to keep tools securely in place. Shipped with a complete list of tools for easy replacement.

Order #	Description	12+	6+	1+
59-2500	Battery Tool Kit	\$26.48	\$28.04	\$31.15

**WATCH TOOL KIT**

This watch kit is specifically designed for watch battery replacement of all brand name watches. The tools included will allow you to open the watch back, remove the old watch battery, safely handle all components, replace your watch batteries, size or replace your watch band, replace or adjust watch band clasp, or remove watch band links.

- Yellow case opener
- Aluminum spring bar tool
- Watchmakers hammer
- Blue band opener
- Bracelet holding block
- Pocket case opener
- 1.6mm screwdriver
- Case holder
- 2.0mm screwdriver
- Multi-function watch band remover
- Plastic tweezers

Order #	Description	12+	6+	1+
59-2600	Watch Tool Kit	\$34.68	\$36.72	\$40.80



Energizer



ENERGIZER® WATCH ELECTRIC BATTERY TESTER

Tests full range of silver, mercury, and coin lithium watch/electronic batteries. Compact, modern design is easy to use. Instructions on bottom of tester.

Order #	Description	12+	6+	1+
59-1000	Tester	\$16.51	\$17.23	\$17.95



ENERGIZER® WATCH BATTERY ANALYZER

Electronic testing device. Determines if there is a problem with the watch or if the battery needs replacing without having to open the watch case. Easy-to-read instruction manual included. Tests all types of batteries: silver-oxide, high-drain, silver-dioxide, low drain, mercury, and lithium.

Order #	Description	12+	6+	1+
59-3000	Analyzer	\$45.01	\$47.66	\$52.95



QT 2500 BATTERY AND PULSE TESTER

Test the pulse of quartz watch movement. Can be checked with movement out of watch case or inside of watch case. Two options to check silver oxide low and high drain battery power. Additionally, this tester allows you to check the coil of the watch movement with the power conductor indicators. Very practical tool for battery and quartz movement changers.

Order #	Description	12+	6+	1+
59-3002	Tester	\$11.73	\$12.42	\$13.80



ANTI-STATIC BENCH MAT

Flexible mat used for organizing tools and projects.

Order #	Description	W x L	12+	6+	1+
59-0488	Light Green	14" x 9½"	\$11.50	\$12.00	\$12.50



BATTERY CHANGING PARTS KIT

Kit contains spare parts for changing watch batteries. Contains battery clamp screws, electronic module screws, battery clamps, insulators, and watch gaskets.

Order #	Description	12+	6+	1+
59-0280	200-piece Kit	\$31.69	\$33.07	\$34.45



ASSORTED BATTERY CLAMPS

Order #	Description	12+	6+	1+
64-5106	Assorted Clamps (Pack of 25)	\$18.35	\$19.15	\$19.95
64-5107	Assorted Clamps (Pack of 30)	\$6.39	\$6.67	\$6.95



100% SILK CARDED BEAD CORD

The beaders prefer the tight-woven silk cord needle attached. When stringing, remove all the cord from the card and string your strand at the end without the twisted stainless steel needle. When you are finished, cut the bead strand off and use the remaining silk (with the needle still attached) for another project. Sold by the card.



Color	White	Dark Pink	Light Pink	Red	Beige	Yellow	Dark Blue	12+	6+	1+	
Size #1	Order #	Order #	Order #	Order #	Order #	Order #	Order #				
	#1	38-5001	—	—	—	—	—	\$1.40	\$1.49	\$1.65	
	#2	38-5002	38-5012	38-5019	38-5022	38-5033	38-5031	38-5009	\$1.40	\$1.49	\$1.65
	#3	38-5003	38-5013	38-5020	38-5023	38-5035	38-5032	38-5043	\$1.40	\$1.49	\$1.65
	#4	38-5004	38-5014	38-5021	38-5024	38-5037	38-5034	38-5044	\$1.40	\$1.49	\$1.65
	#5	38-5005	38-5015	38-5027	38-5025	38-5038	38-5036	38-5045	\$1.40	\$1.49	\$1.65
	#6	38-5006	38-5016	38-5029	38-5026	38-5039	38-5041	38-5046	\$1.40	\$1.49	\$1.65
	#8	38-5008	38-5018	38-5030	38-5028	38-5040	38-5042	38-5048	\$1.83	\$1.94	\$2.15



Color	Lilac	Amethyst	Green	Brown	Turquoise	Gray	Black	12+	6+	1+	
Size #2	Order #	Order #	Order #	Order #	Order #	Order #	Order #				
	#1	38-5047	38-5052	38-5062	38-5072	38-5069	38-5082	38-5092	\$1.40	\$1.49	\$1.65
	#3	38-5049	38-5057	38-5060	38-5063	38-5070	38-5078	38-5093	\$1.40	\$1.49	\$1.65
	#4	38-5050	38-5054	38-5064	38-5074	38-5071	38-5084	38-5094	\$1.40	\$1.49	\$1.65
	#5	38-5051	38-5059	38-5061	38-5065	38-5073	38-5079	38-5080	\$1.40	\$1.49	\$1.65
	#6	38-5053	38-5056	38-5066	38-5076	38-5075	38-5086	38-5096	\$1.40	\$1.49	\$1.65
	#8	38-5055	38-5058	38-5068	38-5067	38-5077	38-5088	38-5098	\$1.83	\$1.94	\$2.15

POLY NYLON (POLYAMID) CARDED BEAD CORD

Poly Nylon, also referred to as "Polyamid", is a strong, fray-resistant, and very knottable stringing material. The nylon card has needle attached. This nylon creates very tight knots and has the stretch of regular nylon. Sold by the card.



Color	White	Dark Pink	Light Pink	Red	Beige	Yellow	Dark Blue	12+	6+	1+	
Size #1	Order #	Order #	Order #	Order #	Order #	Order #	Order #				
	#1	38-4001	—	—	—	—	—	\$1.23	\$1.31	\$1.45	
	#2	38-4002	38-4012	38-4011	38-4022	38-4025	38-4032	38-4042	\$1.23	\$1.31	\$1.45
	#3	38-4003	38-4007	38-4013	38-4020	38-4027	38-4033	38-4038	\$1.23	\$1.31	\$1.45
	#4	38-4004	38-4014	38-4015	38-4024	38-4028	38-4034	38-4044	\$1.23	\$1.31	\$1.45
	#5	38-4005	38-4009	38-4017	38-4021	38-4029	38-4035	38-4039	\$1.23	\$1.31	\$1.45
	#6	38-4006	38-4016	38-4018	38-4026	38-4030	38-4036	38-4046	\$1.23	\$1.31	\$1.45
	#8	38-4008	38-4010	38-4019	38-4023	38-4031	—	38-4040	\$1.27	\$1.35	\$1.50



Color	Lilac	Amethyst	Green	Brown	Turquoise	Gray	Black	12+	6+	1+	
Size #2	Order #	Order #	Order #	Order #	Order #	Order #	Order #				
	#1	38-4041	38-4052	38-4062	38-4072	38-4060	38-4082	38-4092	\$1.23	\$1.31	\$1.45
	#3	38-4043	38-4050	38-4053	38-4057	38-4061	38-4070	38-4093	\$1.23	\$1.31	\$1.45
	#4	38-4045	38-4054	38-4064	38-4074	38-4063	38-4084	38-4094	\$1.23	\$1.31	\$1.45
	#5	—	38-4051	38-4055	38-4059	38-4065	38-4071	38-4073	\$1.23	\$1.31	\$1.45
	#6	38-4048	38-4056	38-4066	38-4076	38-4067	38-4086	38-4096	\$1.23	\$1.31	\$1.45
	#8	38-4049	38-4058	38-4068	38-4078	38-4069	38-4088	38-4098	\$1.27	\$1.35	\$1.50

Beading and Stringing Supplies



100% PURE SILK BEAD STRINGING CORD

Silk is the finest natural fiber in the world. This smooth, twisted three-ply, 100% pure silk thread has the most luxurious feel and softest sheen of any natural fiber. Our bead cord is extremely supple, yet resistant to stretch and wear. Durable enough to withstand the abrasion of pearls, glass beads, and gemstones.

Order #	Thread		Length	Tested Strength	Price		
	Size	Diameter			12+	6+	1+
WHITE CORD							
38-6030	B	0.008" (0.203mm)	390"	3.7 lbs	\$0.00	\$0.00	\$0.00
38-6031	D	0.012" (0.305mm)	260"	5.9 lbs	\$9.14	\$9.68	\$10.75
38-6032	E	0.013" (0.325mm)	200"	8.2 lbs	\$8.67	\$9.18	\$10.20
38-6033	F	0.014" (0.348mm)	140"	10.9 lbs	\$8.67	\$9.18	\$10.20
38-6034	FF	0.017" (0.381mm)	115"	12.8 lbs	\$8.67	\$9.18	\$10.20
BLACK CORD							
38-6038	B	0.008" (0.203mm)	1170"	3.7 lbs	\$8.93	\$10.20	\$12.75
38-6038	D	0.012" (0.305mm)	780"	5.9 lbs	\$8.93	\$10.20	\$12.75
38-6038	E	0.013" (0.325mm)	600"	8.2 lbs	\$8.93	\$10.20	\$12.75
38-6038	F	0.014" (0.348mm)	420"	10.9 lbs	\$8.93	\$10.20	\$12.75
38-6038	FF	0.017" (0.381mm)	84"	12.8 lbs	\$8.93	\$10.20	\$12.75



POLYESTER CORD SPOOLS

Popular polyester thread for stringing pearls. Made in Japan. Sold by the spool.

Item	Order #	Thread Size	Diameter	Length	12+	6+	1+
A	38-6035	20	0.46mm	2000 ft	\$14.20	\$15.03	\$16.70
B	38-6036	30	0.44mm	2000 ft	\$11.35	\$12.02	\$13.35
C	38-6037	40	0.39mm	2000 ft	\$9.73	\$10.31	\$11.45

BEADALON® POLY SPARKLE THREAD

Add some sparkle to your stringing projects. Can be used with other stringing materials or by itself. Use the collapsible eye needle with this material.



Order #	Color	Diameter	Length	12+	6+	1+
38-7195	White	0.027" (0.7mm)	49 ft	\$3.15	\$3.60	\$4.50
38-7196	Silver	0.027" (0.7mm)	49 ft	\$3.15	\$3.60	\$4.50
38-7197	Gold	0.027" (0.7mm)	49 ft	\$3.15	\$3.60	\$4.50
38-7198	Black	0.027" (0.7mm)	49 ft	\$3.15	\$3.60	\$4.50

DIAMETERS AND USES

Actual Size	Size	Diameter	49 Strand	19 Strand	Recommended Uses
	XXS	0.25 (0.010")		•	Seed beads, freshwater pearls, and smaller gemstones. For lightweight stringing and bead weaving.
	XS	0.30 (0.012")		•	Crystal beads, seed beads, and freshwater pearls. Popular with beads with small holes.
	XS	0.33 (0.013")	•		
	S	0.38 (0.015")	•	•	Medium to heavy gemstones, crystals, seed beads, and glass and metal beads. Most versatile sizes for making necklaces, bracelets, and anklets.
	M	0.46 (0.018")	•	•	
	M1	0.51 (0.020")			Large or heavy gemstone beads with unevenly drilled bead holes. For stringing medium-weight designs.
	L	0.53 (0.021")	•	•	
	L1	0.61 (0.024")	•	•	Large or heavy beads with large drill holes such as African trade beads, glass, or gemstones.
	XL	0.66 (0.026")			
	XL	0.76 (0.030")	•		Large glass beads, medium to large crystals, chunky metal, and heavy stone beads. Ideal for stringing larger, heavier beads.
	XXL	0.91 (0.036")	•		

BEADALON® ULTRA SUPPLEMAX

Ultra abrasion-resistant supplemax is a technological advance from Beadalon. This material has 15 times the abrasion resistance of other nylon bead stringing materials. It has a soft white appearance, which makes it look thread-like while maintaining excellent drape.

Order #	Color	Diameter	Length	12+	6+	1+
38-7120	Clear	0.01" (0.25mm)	82 ft	\$1.23	\$1.31	\$1.45
38-7188	White	0.01" (0.25mm)	82 ft	\$2.08	\$2.21	\$2.45
38-7189	White	0.012" (0.3mm)	82 ft	\$2.08	\$2.21	\$2.45

THREAD SIZE CHART

Actual Size	Diameter	Length
—————	#1 = 0.35mm	2 meters (6.5 ft)
—————	#2 = 0.45mm	2 meters (6.5 ft)
—————	#3 = 0.50mm	2 meters (6.5 ft)
—————	#4 = 0.60mm	2 meters (6.5 ft)
—————	#5 = 0.65mm	2 meters (6.5 ft)
—————	#6 = 0.70mm	2 meters (6.5 ft)
—————	#8 = 0.80mm	2 meters (6.5 ft)



ELASTICITY

Make popular stretch jewelry in a snap! Just string beads or charms onto Elasticity and finish with a secure knot. Apply rubber cement to the knot to protect it and provide a professional appearance. Sold in 25 meter spools.

Order #	Color	Diameter	Length	12+	6+	1+
38-7130	Clear	0.02" (0.5mm)	82 ft	\$7.10	\$7.52	\$8.35
38-7131	Clear	0.039" (1mm)	82 ft	\$8.12	\$8.60	\$9.55
38-7133	Black	0.02" (0.5mm)	82 ft	\$7.10	\$7.52	\$8.35
38-7134	Black	0.039" (1mm)	82 ft	\$8.12	\$8.60	\$9.55



BEADALON® WILDFIRE® THREAD

Wildfire beading thread features the strength and durability of DandyLine, with a smooth, thermally-bonded coating, creating a superior stringing product that cannot be pierced with a needle. Super strong, waterproof, and near zero-stretch, this cord will not fray at the ends, making it easy to thread through a needle. This colorfast, knotable, supple cord is also available for multiple-strand seeded bead designs.

Order #	Color	Diameter	Length	12+	6+	1+
38-7191	Black	0.006" (0.15mm)	50 ft	\$6.62	\$7.56	\$9.45
38-7192	White	0.006" (0.15mm)	50 ft	\$6.62	\$7.56	\$9.45
38-7193	Black	0.008" (0.02mm)	50 ft	\$6.62	\$7.56	\$9.45
38-7194	White	0.008" (0.02mm)	50 ft	\$6.62	\$7.56	\$9.45



Beading and Stringing Supplies



COLLAPSIBLE EYE NEEDLES

Perfect for stringing beads with very small holes. Needles have a specially designed eye that automatically collapses and instantly reshapes when it is pulled through the bead. Needles are five inches long and kink-resistant.



Order #	Description	Diameter	12+	6+	1+
38-0106	Fine	0.012" (0.30mm)	\$2.64	\$2.79	\$3.10
38-0107	Medium	0.014" (0.36mm)	\$2.64	\$2.79	\$3.10
38-0108	Heavy	0.020" (0.51mm)	\$2.64	\$2.79	\$3.10



TWISTED-BEAD NEEDLES

Twisted-bead needles, ideal for general beading. Approximately 3½" long and flexible.



Order #	Description	Diameter	12+	6+	1+
38-0100	Fine	0.23mm	\$4.17	\$4.41	\$4.90
38-0101	Medium	0.35mm	\$4.17	\$4.41	\$4.90
38-0102	Heavy	0.49mm	\$4.17	\$4.41	\$4.90



SBEADY™ WIRE NEEDLES

An easy way to string beads onto Beadalon wire — use the Beadalon Sbeady Wire Needle. The Sbeady Wire Needle comes in four sizes that correspond to Beadalon wire sizes.

Order #	Description	Length	Unit Size	12+	6+	1+
38-0119	Assorted	1½"	Pack of 4	\$21.04	\$22.28	\$24.75

USING THE SBEADY WIRE NEEDLE

Just slip the wire into the end of the needle using the easy-slide, half-open portion to guide the wire into the hollow needle. Push the wire all the way in, and you're ready to string!



BRASS BEADING NEEDLES

Easy threading is yours with this needle; the eye runs the entire length of the needle!



Order #	Description	Diameter	12+	6+	1+
38-0907	Small	0.30mm	\$6.49	\$6.77	\$7.05
38-0908	Medium	0.39mm	\$6.49	\$6.77	\$7.05
38-0909	Large	0.48mm	\$6.35	\$6.62	\$6.90

KINK-FREE TI™ - TITANIUM BEAD STRINGING WIRE

The first nylon-coated, kink-free beading wire. This technologically advanced titanium alloy wire is super-elastic and offers dramatic kink resistance. When pinched and released, the wire returns to its original straight shape without kinking. Ideal for use on jewelry designs subject to lots of twisting, looping, and extreme movement, the wire holds its shape and works well on designs made with crystal, metal, and medium to heavier weight beads. Made in the USA.



Order #	Diameter (Thickness)	Length	MFG Model	Shank	Tested Strength	12+	6+	1+
38-7114	0.015" (0.38mm)	10 ft	#2	#1	33 lbs	\$30.45	\$34.80	\$43.50
38-7114	0.018" (0.46mm)	10 ft	#2	#1	44 lbs	\$30.45	\$34.80	\$43.50

49 STRAND, PLATED COLORS

Create stunning designs with the luxurious sheen of precious metal. 49 Strand Silver Plated wires combine the softness and flexibility of traditional 49 Strand with the strength of steel. Clear nylon coating over silver or 24kt gold-plated stainless steel wire. Made in the USA.

Order #	Surface Coating	Diameter	Length	Tested Strength	12+	6+	1+
38-7006	Silver Plated	0.015" (0.38mm)	10 ft	20 lbs	\$15.34	\$16.25	\$18.05
38-7071	Gold Plated	0.018" (0.46mm)	10 ft	26 lbs	\$14.41	\$15.26	\$16.95
38-7070	Gold Plated	0.015" (0.38mm)	10 ft	20 lbs	\$14.41	\$15.26	\$16.95
38-7007	Silver Plated	0.018" (0.46mm)	10 ft	26 lbs	\$14.45	\$15.30	\$17.00



Gold-Plated



Silver-Plated



49 STRAND, STANDARD COLORS

Combines the flexibility and softness of thread with the strength and durability of stainless steel wire. Designed for stringing all types of beads and pearls, Beadalon 49 Strand is the softest and most popular beading wire. It drapes very naturally without kinking. It is the finest choice wire for creating professional jewelry that remains securely strung. The smooth nylon coating provides abrasion resistance, prevents kinking, and prolongs strand life. Made in the USA.

Order #	Surface Coating	Diameter	Length	Tested Strength	12+	6+	1+
38-7090	Bright	0.013" (0.33mm)	30 ft	13 lbs	\$24.40	\$25.83	\$28.70
38-7091	Bright	0.015" (0.38mm)	30 ft	20 lbs	\$11.94	\$12.65	\$14.05
38-7092	Bright	0.018" (0.46mm)	30 ft	26 lbs	\$10.41	\$11.03	\$12.25
38-7093	Bright	0.024" (0.61mm)	30 ft	40 lbs	\$11.27	\$11.76	\$12.25
38-7050	Black	0.015" (0.38mm)	30 ft	20 lbs	\$14.75	\$15.62	\$17.35
38-7052	Black	0.018" (0.46mm)	30 ft	26 lbs	\$14.75	\$15.62	\$17.35
38-7060	Bronze	0.015" (0.38mm)	30 ft	20 lbs	\$13.56	\$14.36	\$15.95
38-7062	Bronze	0.018" (0.46mm)	30 ft	26 lbs	\$16.70	\$17.68	\$19.65



Bright

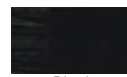

Black



Bronze



49 STRAND

- Softest, Most Supple
- Maximum Flexibility
- Maximum Drape
- Maximum Kink Resistance
- Maximum Abrasion Resistance
- Superior Strength

19 STRAND

- Excellent Flexibility
- Excellent Drape
- Excellent Kink Resistance
- Excellent Abrasion Resistance
- Superior Strength

Bead and Stringing Supplies



19-STRAND, PLATED COLORS

Supple 19-strand stainless steel wire is plated with silver or 24kt gold, then coated with clear, soft nylon. Combine the flexibility and strength of 19-strand wire with the luster of precious metals. Choose brilliant silver plated wire to coordinate with sterling silver or silver-plated findings. Glimmering 24kt Gold Plated wire complements gold and plated metal jewelry components for finer quality jewelry designs. Made in the USA.

Order #	Surface Coating	Diameter	Length	Tested Strength	12+	6+	1+
38-7104	Silver Plated	0.015" (0.38mm)	15 ft	17 lbs	\$8.79	\$9.17	\$9.55
38-7105	Silver Plated	0.018" (0.46mm)	15 ft	26 lbs	\$8.79	\$9.17	\$9.55
38-7100	Gold Plated	0.015" (0.38mm)	15 ft	17 lbs	\$15.59	\$16.27	\$16.95
38-7101	Gold Plated	0.018" (0.46mm)	15 ft	26 lbs	\$15.59	\$16.27	\$16.95

19-STRAND, STANDARD COLORS

Specifically developed for bead stringing, Beadalon 19-strand is an ideal choice for creating jewelry designs or repairs. Only slightly less flexible than 49-strand, with less cost, this wire contains 19 strands of strong stainless steel. Nylon coated for increased kink and abrasion resistance, Beadalon 19-strand is easy to work with, very strong, and perfect for jewelry that lasts. Made in the USA.



Order #	Surface Coating	Diameter	Length	Tested Strength	12+	6+	1+
38-7085	Bright	0.01" (0.25mm)	30 ft	17 lbs	\$8.67	\$9.18	\$10.20
38-7086	Bright	0.012" (.30mm)	30 ft	12 lbs	\$9.05	\$9.59	\$10.65
38-7087	Bright	0.015" (0.38mm)	30 ft	17 lbs	\$8.59	\$9.09	\$10.10
38-7088	Bright	0.018" (0.46mm)	30 ft	26 lbs	\$9.35	\$9.90	\$11.00
38-7118	Bronze	0.021" (.53mm)	30 ft	35 lbs	\$10.37	\$10.98	\$12.20
38-7113	Black	0.018" (0.46mm)	30 ft	26 lbs	\$10.37	\$10.98	\$12.20
38-7116	Bronze	0.015" (.38mm)	30 ft	17 lbs	\$9.52	\$10.08	\$11.20
38-7117	Bronze	0.018" (.46mm)	30 ft	26 lbs	\$9.52	\$10.08	\$11.20
38-7112	Black	0.015" (0.38mm)	30 ft	35 lbs	\$9.99	\$10.58	\$11.75

19-STRAND, SATIN COLOR

"Satin Colors" give designs a soft, warm glow of silver, gold, and copper. The special nylon coating on Satin Colors offers a soft, silky feel and a unique, matte coloring. The coating also creates a softer more supple feel and drape. Great for designs requiring exposed wire. Made in the USA.



Order #	Surface Coating	Diameter	Length	Tested Strength	12+	6+	1+
38-7121	Satin Gold	0.015" (.38mm)	30 ft	12 lbs	\$9.99	\$10.58	\$11.75
38-7126	Satin Silver	0.018" (.46mm)	30 ft	17 lbs	\$10.63	\$11.25	\$12.50
38-7125	Satin Silver	0.015" (.38mm)	30 ft	12 lbs	\$10.20	\$10.80	\$12.00
38-7122	Satin Gold	0.018" (.46mm)	30 ft	17 lbs	\$11.94	\$12.65	\$14.05

19-STRAND, BEADALON VARIETY PACK WIRE

Metallic colors combine the rich look and brilliant shine of gold and silver with the dramatic flexibility and softness of 19-strand. Silver color is a value-priced silver-plated wire. It is comprised of a blend of tarnish-resistant metals with actual silver plating. Gold color and champagne are made of a mix of tarnish-resistant metals. These mixed-metal wires have slightly lower breaking strengths than other Beadalon 19-strand stainless steel wires. Use the metallic color wire with silver and gold findings to render the shimmer and shine of fine jewelry. Comes with one spool of each of the following: gold, silver, and champagne.



Order #	Diameter	Length	12+	6+	1+
38-7190	0.015" (0.38mm)	10 ft	\$17.47	\$19.96	\$24.95



GERMAN-STYLE PLATED WIRE

Excellent quality shaping wire, available in several gauges and shapes. This copper and brass wire has a tarnish-resistant coating and has the perfect temper and finish for most jewelry wire wrapping uses. Fancy Round wire is constructed of two strands of round wire that have been twisted together, then run through tooling to make the outside round again (instead of the usual swirl/bumps of twisted wire) creating a very unique pattern.

Order #	Color	Gauge	Diameter	Length	12+	6+	1+
ROUND							
38-7096	Silver Plated	20	0.032" (0.81mm)	19 ⁷ / ₁₀ ft	\$2.98	\$3.40	\$4.25
38-7096	Silver Plated	24	0.020" (0.51mm)	39 ⁵ / ₈ ft	\$2.98	\$3.40	\$4.25
38-7097	Brass Plated	20	0.032" (0.81mm)	19 ⁷ / ₁₀ ft	\$2.98	\$3.40	\$4.25
38-7097	Brass Plated	24	0.020" (0.51mm)	39 ⁵ / ₈ ft	\$2.98	\$3.40	\$4.25
SQUARE							
38-7098	Silver Plated	20	0.032" (0.81mm)	6 ¹ / ₂ ft	\$5.22	\$5.96	\$7.45
38-7099	Brass Plated	20	0.032" (0.81mm)	6 ¹ / ₂ ft	\$5.22	\$5.96	\$7.45
HALF-ROUND							
38-7108	Silver Plated	20	0.032" (0.81mm)	9 ³ / ₄ ft	\$2.77	\$2.77	\$2.77
38-7109	Brass Plated	20	0.032" (0.81mm)	9 ³ / ₄ ft	\$6.33	\$6.71	\$7.45
FANCY							
38-7110	Silver Plated	20	0.032" (0.81mm)	6 ¹ / ₂ ft	\$4.09	\$4.09	\$4.09
38-7111	Brass Plated	20	0.032" (0.81mm)	6 ¹ / ₂ ft	\$7.70	\$8.80	\$11.00



WIRE BENDING PLIERS

The bend in these pliers reduces the time needed to create professional wire wrapping and stone setting. Each end of the T-shaped head fits a different gauge.

Item	Order #	Gauge (for bending)	12+	6+	1+
A	46-4040	22, 24 gauge	\$18.70	\$19.80	\$22.00
	46-4040	20, 21 gauge	\$18.70	\$19.80	\$22.00

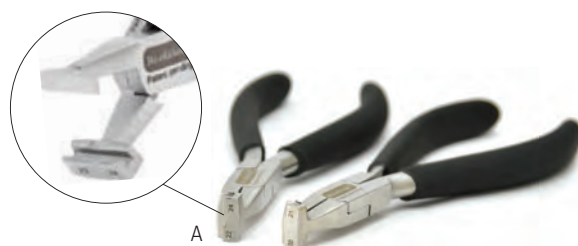

COILING GIZMO DELUXE WINDER

Features built-in, table-mount base, five crank-rods of different sizes, and instructions. The thinnest rod will handle fine wires, while the larger rods will help you make your own jump rings.

Item	Order #	Description	12+	6+	1+
B	38-0188	Wire Coiling Jump Ring Maker	\$10.33	\$10.94	\$12.15



WIRE TWISTER AND JUMP RING MAKER

Together in one convenient set, you can twist wire and make custom jump rings in the sizes and wire gauges you want. The Jump Ring Maker comes in different configurations so you can make just the size you need. Use the wire twister to make pre twisted color combinations, then make twisted jump rings for all your jewelry or craft projects. Easy to use, fast, and fun.

Item	Order #	Description	12+	6+	1+
C	38-0189	Wire Twisting/Jump Ring Making Combo Set	\$52.45	\$55.53	\$61.70



COLOURCRAFT SPIRAL MAKER

Creates perfect spirals out of any metal wire up to 20 gauge. Use small pieces of the diameter wire you intend to make the spiral, as a washer on the three screws. Tighten nut and insert the same gauge wire into the device. Center the wire in the center hole and insert the twister handle so the wire is inside the slit on the handle. Twist the handle until the desired size of coil is reached (maximum of 16mm).

Item	Order #	Description	Diameter	12+	6+	1+
D	38-9024	Standard	5/8" (16mm)	\$14.54	\$15.39	\$17.10
	38-9025	Large	1 1/4" (32mm)	\$15.94	\$16.88	\$18.75



Beading and Stringing Supplies



A



B



C



D



E



F



G

ARTISTIC WIRE

These wires are made by first plating the copper wire with a precision layer of pure silver. Then we carefully apply our unique enamel color and tarnish resistant coating on top of this silver plating. The silver plating beneath the color adds an incredible high shine and brilliance to the wire.

Item	Order #	Surface Coating	Gauge	Length	12+	6+	1+
A	38-0012	Brass Plated	22	8 yds	\$2.28	\$2.60	\$3.25
	38-0012	Brass Plated	20	6 yds	\$2.28	\$2.60	\$3.25
B	38-0011	Silver Plated	22	8 yds	\$4.13	\$4.72	\$5.90
	38-0011	Silver Plated	20	6 yds	\$4.13	\$4.72	\$5.90

ARTISTIC WIRE KITS

Buy the Dozen packs feature all one gauge per package. Provide your customers with the best vari-pack on the market.



Item	Order #	Surface Coating	Gauge	Length	12+	6+	1+
C	38-0000	Multi	20	5 yds	\$9.31	\$10.64	\$13.30
	38-0000	Multi	24	5 yds	\$9.31	\$10.64	\$13.30
	38-0000	Multi	22	5 yds	\$9.31	\$10.64	\$13.30
D	38-0001	Multi	22	5 yds	\$12.06	\$12.06	\$12.06
	38-0001	Multi	20	5 yds	\$21.53	\$24.60	\$30.75

ARTISTIC WIRE - 3 PACKS

Artistic Wire 3-Packs feature all one gauge per package and three different colors. These colors are specially selected to go together in any project.



Item	Order #	Surface Coating	Gauge	Length	12+	6+	1+
E	38-0003	Black, Natural, Gun	20	3 yds	\$3.40	\$3.83	\$4.25
	38-0003	Black, Natural, Gun	22	5 yds	\$3.40	\$3.83	\$4.25
F	38-0004	Silver, Brass, Hematite	20	3 yds	\$3.40	\$3.83	\$4.25
	38-0004	Silver, Brass, Hematite	22	5 yds	\$3.40	\$3.83	\$4.25

ARTISTIC WIRE - TWISTED

Give your designs a twist with Artistic Wire Twisted! Three strands are twisted together to make a truly unique textured wire. Use this wire in your designs to add an interesting appearance and feel.

Item	Order #	Surface Coating	Gauge	Length	12+	6+	1+
G	38-0009	Silver Plated	20	3 yds	\$5.22	\$5.96	\$7.45



FRENCH WIRE (BULLION)

Use this coiled, fine-gauge wire on knotted strands to keep clasps from wearing on or cutting through unprotected silk or bead cord. It creates a professional appearance and is commonly used as the preferred method for stringing pearls.

Order #	Surface Coating	Diameter	Pack Quantity	12+	6+	1+
38-6051	Gold Plated	0.024" (0.8mm)	1m	\$6.99	\$7.30	\$7.60
38-6052	Gold Plated	0.027" (0.9mm)	1m	\$6.46	\$6.84	\$7.60
38-6053	Gold Plated	0.031" (1mm)	1m	\$8.33	\$8.69	\$9.05
38-6064	Silver Plated	0.035" (1.1mm)	1m	\$6.99	\$7.30	\$7.60
38-6061	Silver Plated	0.024" (0.8mm)	1m	\$6.99	\$7.30	\$7.60
38-6062	Silver Plated	0.027" (0.9mm)	1m	\$8.33	\$8.69	\$9.05
38-6063	Silver Plated	0.031" (1mm)	1m	\$6.99	\$7.30	\$7.60
38-6054	Gold Plated	0.035" (1.1mm)	1m	\$15.50	\$16.18	\$16.85

ASSORTMENTS

38-6050	Gold Plated	Assortment (all)	4m	\$17.57	\$18.34	\$19.10
38-6060	Silver Plated	Assortment (all)	4m	\$15.50	\$16.18	\$16.85



20"



49-STRAND JEWELRY CABLE

Ideal for metal beading and for interesting jewelry designs. Try separating the strands to create interesting individual wavy cables, then add beads and finish with a crimp and clasp for stylish and unique creations!

Item	Order #	Material	Diameter	Length	12+	6+	1+
A	38-8010	Stainless Steel	0.036" (0.92mm)	30'	\$10.16	\$10.76	\$11.95
B	38-8012	Stainless Steel	0.045" (1.14mm)	30'	\$10.29	\$10.89	\$12.10



SHAPED MEMORY WIRE

String on beads for a flexible design that retains its round shape. Do not use cutters to cut. Bend back and forth to "break" metal, then use pliers to coil the end around or use end caps available at right. Wire diameter is .025" (.62mm).

Item	Order #	Description	Per Pack	12+	6+	1+
C	38-7140	Ring	195 coils	\$7.61	\$8.06	\$8.95
	38-7141	Small Bracelet	75 coils	\$7.61	\$8.06	\$8.95
	38-7142	Large Bracelet	60 coils	\$7.61	\$8.06	\$8.95
	38-7143	Small Necklace	36 coils	\$7.61	\$8.06	\$8.95
	38-7144	Large Necklace	32 coils	\$7.61	\$8.06	\$8.95



C



D



MEMORY WIRE END CAPS VARIETY PACK

Finish off Remembrance Wire designs with End Caps for a professional look. End Caps are open on one side to accommodate Remembrance and Plated Steel Memory Wire. End Caps are a fun way to dangle charms. Secure the End Cap and last few beads with BeadFix adhesive for a fast and easy finish.

Item	Order #	Surface Coating	Thickness	Per Pack	12+	6+	1+
D	38-7154	Silver Plated	3-4mm	72	\$7.11	\$8.12	\$10.15

Beading and Stringing Supplies



EASY EAR WIRE

Easy to use, fully automatic, and hand-operated. Just put in a straight piece of wire and in seconds you will have an elegant ear wire ready for use. So easy and quick you will not need to keep an inventory of ear wires for your earrings. Simply make them as you need them.

Order #	Description	12+	6+	1+
38-9023	Ear Wire Maker	\$22.06	\$23.36	\$25.95



Kit available in five different styles.

SCRIMP™ KIT

Scrimp Findings are an innovative screw finding that takes the place of a crimp, and are reusable. A tiny set screw inside holds Beadalon wires in place. The complete Scrimp Kit contains its own screwdriver and an ample supply of Scrimp Findings with screws. Additional screws are cleverly held within the handle of the screwdriver. A secure—and flexible—finish! See tip diagram below!

Assortment Quantity:

Stainless - 4 Plated - 10

Order #	Description	Surface Coating	12+	6+	1+
38-7155	3.5mm Magnetic	Stainless Steel	\$13.86	\$15.03	\$16.70
38-7161	Bullet	Silver Plated	\$7.64	\$8.28	\$9.20
38-7156	3.5mm Oval	Silver Plated	\$8.88	\$9.63	\$10.70
38-7160	Bullet	Gold Plated	\$7.64	\$8.28	\$9.20



INDIVIDUAL SCRIMP™ FINDINGS

Scrimp Findings are the unique marriage of a screw finding within a crimp—a fresh alternative.

Assortment Quantity:

Stainless - 6 Plated - 10

Item	Order #	Description	Surface Coating	12+	6+	1+
A	38-7164	Magnetic	Stainless Steel	\$15.56	\$16.88	\$18.75
B	38-7163	Bullet	Silver Plated	\$5.35	\$5.81	\$6.45
C	38-7165	Oval	Silver Plated	\$6.35	\$6.89	\$7.65
D	38-7162	Bullet	Gold Plated	\$5.35	\$5.81	\$6.45
E	38-7166	Oval	Gold Plated	\$6.35	\$6.89	\$7.65
F	38-7167	Oval	Copper Plated	\$6.35	\$6.89	\$7.65



SCRIMP FINDING INSTRUCTIONS

1. Begin by loosening screw to allow wire to go through the Scrimp Finding.
2. Feed the wire through the Scrimp Finding, onto a Wire Guardian [optional], attach a clasp, and feed back through the Scrimp Finding.
3. Tighten screw for a secure and clean finish.

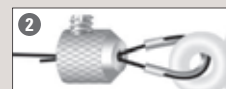

TIP: For an extra strong Scrimp Finding, add a small amount of BeadFix to the screw.

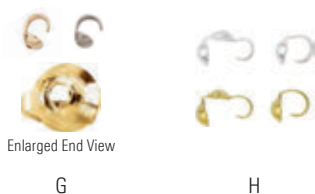

BEAD TIPS

Item	Order #	Quality	Hole ID	6+	3+	1+
G	262	Nickel Plated	.71mm	\$0.24	\$0.24	\$0.24
	262	Yellow Plated	.71mm	\$0.31	\$0.32	\$0.32
H	263	Nickel Plated	.92mm	\$0.38	\$0.39	\$0.39
	263	Yellow Plated	.92mm	\$0.34	\$0.35	\$0.35

Order #	Size	OD	ID	Type	Surface Coating	Per Pack	12+	6+	1+
BEADALON									
38-7000	#1	2mm	1.3 mm	Bead	Silver Plated	430	\$4.42	\$4.68	\$5.20
38-7001	#1	2mm	1.3 mm	Bead	Gold Plated	430	\$4.42	\$4.68	\$5.20
38-7002	#1	2mm	1.3 mm	Bead	Black Plated	430	\$4.42	\$4.68	\$5.20
38-7003	#2	2.5mm	1.5 mm	Bead	Silver Plated	400	\$4.21	\$4.46	\$4.95
38-7004	#2	2.5mm	1.5 mm	Bead	Gold Plated	400	\$4.21	\$4.46	\$4.95
38-7005	#2	2.5mm	1.5 mm	Bead	Black Plated	400	\$4.21	\$4.46	\$4.95
38-7010	#1	1.3mm	0.8 mm	Tube	Silver Plated	470	\$4.76	\$5.04	\$5.60
38-7011	#1	1.3mm	0.8 mm	Tube	Gold Plated	370	\$4.76	\$5.04	\$5.60
38-7012	#2	1.8mm	1.3 mm	Tube	Silver Plated	365	\$3.83	\$4.05	\$4.50
38-7013	#2	1.8mm	1.3 mm	Tube	Gold Plated	365	\$3.83	\$4.05	\$4.50
38-7014	#3	2mm	1.5 mm	Tube	Silver Plated	384	\$4.04	\$4.28	\$4.75
38-7015	#3	2mm	1.5 mm	Tube	Gold Plated	384	\$4.04	\$4.28	\$4.75
38-7016	#4	2.5mm	2 mm	Tube	Silver Plated	234	\$4.51	\$4.70	\$4.90
38-7017	#4	2.5mm	2 mm	Tube	Gold Plated	234	\$4.51	\$4.70	\$4.90
PRECIOUS METAL									
24057	#1	2.5mm	1.35mm	Tube	14kt Gold	Each	\$4.31	\$4.38	\$4.38
24057	#1	2.5mm	1.35mm	Tube	Sterling Silver	Each	\$0.24	\$0.24	\$0.25
24058	#1	2mm	1.37mm	Tube	14kt Gold	Each	\$2.22	\$2.26	\$2.26
24058	#1	2mm	1.37mm	Tube	Sterling Silver	Each	\$0.14	\$0.14	\$0.14

CRIMP BEADS AND CRIMP TUBES

Now it's easier than ever to have the correct size Crimp Bead or Tube handy for repairs or beading. Each individual bottle is marked with the Crimp Bead and Crimp Tube size number that corresponds to the information on all Beadalon wire packages to make using and storing the proper sizes very easy.



CRIMP BEAD AND TUBE VARIETY PACK



Order #	Quality	Pcs #0	Pcs #1	Pcs #2	Pcs #3	12+	6+	3+	1+
BEAD									
24143	Silver Plated	250	150	125	75	\$19.80	\$21.15	\$21.83	\$22.50
24143	Gold Plated	250	150	125	75	\$19.80	\$21.15	\$21.83	\$22.50
TUBE									
24035	Yellow Plated	250	150	125	75	\$19.80	\$21.15	\$21.83	\$22.50
24035	Sterling Silver	250	150	125	75	\$19.80	\$21.15	\$21.83	\$22.50



WIRE GUARDIANS

Protect stringing materials from undue wear with Wire Guardians. Reduce abrasion from clasps or other sharp-edged components. Use Wire Guardians in the same way as French Wire; the only difference is the Wire Guardian is rigid. For wire diameters up to 0.53mm (0.021").

Item	Order #	Surface Coating	ID	Per Pack	12+	6+	1+
A	38-7171	Silver Plated	0.022"	20	\$2.99	\$3.24	\$3.60
B	38-7170	Gold Plated	0.022"	20	\$2.99	\$3.24	\$3.60
C	38-7172	Copper Plated	0.022"	20	\$2.99	\$3.24	\$3.60
D	24059	14kt Yellow	0.021"	20	\$5.06	\$5.15	\$5.15
	24059	Sterling Silver	0.021"	20	\$0.33	\$0.34	\$0.35



MYSTERY CLASPS

Mystery clasps are made to be glued into enlarged drill holes in the end of pearls. The mechanism disappears when the two parts are screwed together.

Item	Order #	Quality	W x L	6+	3+	1+
E	20313	BRASS	2mm x 6.5mm	\$6.35	\$6.55	\$6.75
	20313	Nickel Plated	2mm x 6.5mm	\$6.35	\$6.55	\$6.75
F	20312	BRASS	2.5mm x 7mm	\$6.35	\$6.55	\$6.75
	20312	Nickel Plated	2.5mm x 7mm	\$6.35	\$6.55	\$6.75



Beading and Stringing Supplies

BEAD BUMPERS

Use Bead Bumpers instead of knots to separate and add interest to designs strung on Beadalon wire. Simply string one Bead Bumper in between each bead of a design to space beads evenly. Once incorporated, the Bumpers look similar to a knot and keep the beads from rubbing against one another. Since Bead Bumpers are made of a special stretch material, they can be added to Beadalon wires up to 0.024" in diameter. Bead Bumpers are also great for Memory Wire designs and knotted or tin-cup style looks.



Order #	Color	Shape	Thickness	12+	6+	1+
38-7200	White	Oval	1.5mm	\$5.20	\$5.42	\$5.65
38-7201	Black	Oval	1.5mm	\$5.20	\$5.42	\$5.65
38-7202	Clear	Oval	1.5mm	\$5.20	\$5.42	\$5.65
38-7209	Silver	Oval	1.5mm	\$6.76	\$7.06	\$7.35
38-7210	Gold	Oval	1.5mm	\$6.76	\$7.06	\$7.35
38-7203	White	Oval	2mm	\$5.20	\$5.42	\$5.65
38-7204	Black	Oval	2mm	\$5.20	\$5.42	\$5.65
38-7205	Clear	Oval	2mm	\$5.20	\$5.42	\$5.65
38-7211	Silver	Oval	2mm	\$6.76	\$7.06	\$7.35
38-7212	Gold	Oval	2mm	\$6.76	\$7.06	\$7.35
38-7206	White	Cube	1.7mm	\$5.20	\$5.42	\$5.65
38-7207	Black	Cube	1.7mm	\$5.20	\$5.42	\$5.65
38-7208	Clear	Cube	1.7mm	\$5.20	\$5.42	\$5.65
38-7213	Silver	Cube	1.7mm	\$3.15	\$3.15	\$3.15
38-7214	Gold	Cube	1.7mm	\$8.00	\$8.35	\$8.70

LIGHTWEIGHT BEAD

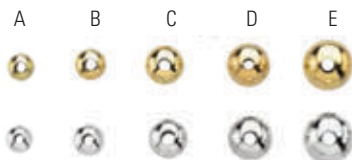

Item	Order #	Quality	OD	Hole ID	6+	1+
A	863	14kt Gold	3mm	1.5mm	\$2.11	\$2.14
	863	Sterling Silver	3mm	1.5mm	\$0.50	\$0.53
B	864	14kt Gold	4mm	1.45mm	\$3.46	\$3.52
	864	Sterling Silver	4mm	1.45mm	\$0.74	\$0.77
C	865	14kt Gold	5mm	1.45mm	\$5.80	\$5.89
	865	Sterling Silver	5mm	1.45mm	\$1.22	\$1.27
D	866	14kt Gold	6mm	1.8mm	\$10.15	\$10.44
	866	Sterling Silver	6mm	1.8mm	\$1.79	\$1.87
E	867	14kt Gold	7mm	2.2mm	\$12.05	\$12.43
	867	Sterling Silver	7mm	2.2mm	\$2.49	\$2.61



CRIMP COVERS

Item	Order #	Quality	OD	12+	6+	1+
F	24056	14kt Gold	3mm	\$7.02	\$7.15	\$7.35
	24056	Sterling Silver	3mm	\$0.40	\$0.40	\$0.42
G	24055	Sterling Silver	4mm	\$0.97	\$0.99	\$1.03



STERLING SILVER FANCY BEAD CAP

Item	Order #	OD	Hole ID	6+	1+
H	24913	9mm	1.5mm	\$6.07	\$6.69
J	24914	6mm	1.5mm	\$1.70	\$1.88
K	24915	8mm	1.4mm	\$4.92	\$5.43



STERLING SILVER FLUTED BEAD CAP

Item	Order #	OD	Hole ID	6+	1+
L	24908	7mm	1.7mm	\$3.96	\$4.36
M	24912	10.5mm	1.5mm	\$9.00	\$9.92



STERLING SILVER PETAL BEAD CAP

Item	Order #	OD	Hole ID	6+	1+
N	24904	7mm	1.1mm	\$3.29	\$3.62
P	24905	6.5mm	1mm	\$1.76	\$1.94

SINGLE STAND PEARL CLASPS

Item	Order #	Quality	W x L	6+	3+	1+
A	94	Yellow Gold Filled	5.3mm x 11.1mm	\$6.60	\$6.77	\$6.95
	94	14kt Gold	5.3mm x 11.1mm	\$45.31	\$46.03	\$46.75
	94	Sterling Silver	5.3mm x 11.1mm	\$5.55	\$5.66	\$5.82
B	101	Yellow Gold Filled	8mm x 16mm	\$14.77	\$15.18	\$15.59
	101	Sterling Silver	8mm x 16mm	\$11.06	\$11.28	\$11.60
C	109	14kt Gold	5.75mm x 13.5mm	\$70.43	\$70.87	\$74.37
D	22532	Sterling Silver	6mm x 12.25mm	\$5.40	\$5.50	\$5.66
E	102	14kt Gold	5.75mm x 12mm	\$63.91	\$64.33	\$67.66
F	23373	14kt Gold	5.3mm x 11.1mm	\$45.55	\$46.27	\$47.00

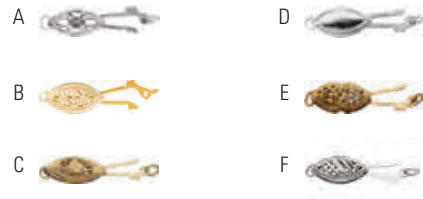

MAGNETIC CLASPS

Item	Order #	Quality	W x L or Diameter	6+	3+	1+
G	24283	Sterling Silver	7mm (diameter)	\$9.99	\$10.19	\$10.48
H	28506	Sterling Silver	5mm x 15.5mm	\$7.20	\$7.35	\$7.57
	28506	14kt Gold	4.3mm x 15.5mm	\$42.81	\$43.13	\$45.66
J	28294	Sterling Silver	6mm (diameter)	\$23.04	\$23.50	\$24.18
	28294	Gold	6mm (diameter)	\$31.43	\$32.07	\$33.04
K	28293	Sterling Silver	5.5mm (diameter)	\$22.72	\$23.17	\$23.86
	28293	Gold	5.5mm (diameter)	\$31.43	\$32.07	\$33.04
L	24314	14kt Gold	8mm x 25mm	\$26.69	\$26.98	\$29.33
	24314	Silver Plated	8mm x 25mm	\$26.69	\$26.98	\$29.33
M	24313	Sterling Silver	7.3mm x 19mm	\$52.34	\$55.91	\$59.47
	24313	Sterling Silver	7.3mm x 19mm	\$41.70	\$42.16	\$45.82
	24313	Sterling Silver	7.3mm x 19mm	\$26.69	\$26.98	\$29.33
	24313	Silver Plated	7.3mm x 19mm	\$26.69	\$26.98	\$29.33
N	22485	Sterling Silver	5.5mm x 21.25mm	\$25.51	\$25.99	\$26.71
	22485	Sterling Silver	4.5mm x 20.25mm	\$24.40	\$24.87	\$25.58

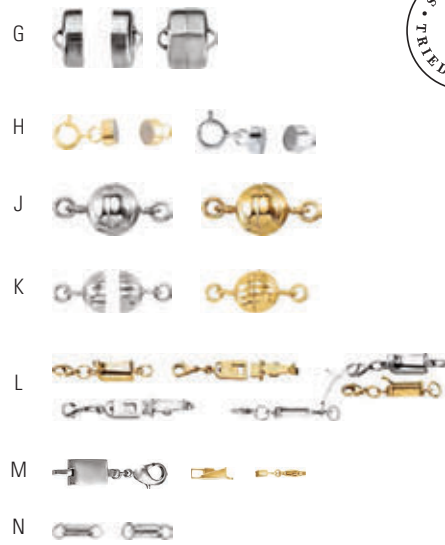

LINK LOCK™

Order #	Quality	mm ID	mm OD	Thickness	12+	6+	1+
20999	14kt Gold	2.25 x 4.25	5 x 8	1.2mm	\$24.77	\$25.83	\$26.90
20999	Sterling Silver	5 x 8	5 x 8	1.2mm	\$5.86	\$6.19	\$6.66



LINK LOCK™

Securely attach charms or dangles without soldering using the rotating crimp collar on the link lock



Open

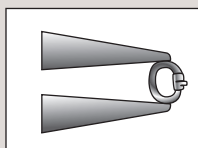

Attach items to be joined to Link Lock. Close the Link Lock with a set of pliers.

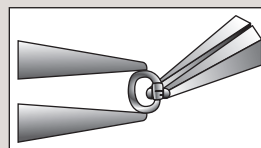

With a second set of pliers, turn the locking collar into position and squeeze to permanently secure.



Closed

Beading and Stringing Supplies

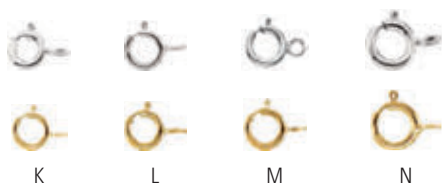
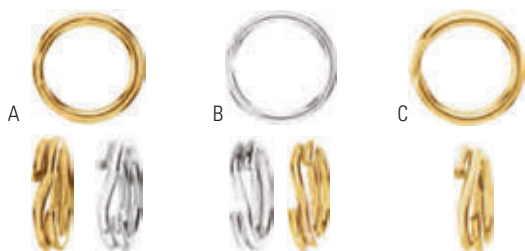

ROUND SPLIT RING

Item	Order #	Description	OD	Thickness	12+	6+	1+
A	RD1	14K Yellow or White	5mm	1mm	\$11.93	\$12.11	\$12.29
	RD1	Sterling Silver	5mm	1mm	\$0.47	\$0.48	\$0.50
	RD1	Yellow or White Gold Filled	5mm	1mm	\$2.17	\$2.23	\$2.23
B	RD2	14K Yellow or White	6.5mm	1mm	\$19.79	\$20.05	\$20.31
	RD2	Sterling Silver	6.5mm	1mm	\$0.95	\$0.97	\$0.99
	RD2	Yellow or White Gold Filled	6.5mm	1mm	\$2.69	\$2.76	\$2.76
C	RD3	14K Yellow or White	7.5mm	1.5mm	\$30.28	\$30.71	\$31.13
	RD3	Sterling Silver	7.5mm	1.5mm	\$1.20	\$1.22	\$1.26
	RD3	Yellow or White Gold Filled	7.5mm	1.5mm	\$2.80	\$2.88	\$2.88

MICRO MINI PLIERS

These pliers are a great choice for product assembly or bead stringing. To open split rings, insert the tooth onto the side of the ring and squeeze gently.

Order #	Description	Length	12+	6+	1+
46-3070	Split Ring Pliers	5 1/4"	\$7.78	\$8.24	\$9.15

SPLIT RING TWEEZERS

An easy-to-use tweezer for opening small to medium split rings. Just put the split ring under the claw and squeeze. The tweezer is made of stainless steel.

Order #	Description	Length	12+	6+	1+
57-7640	Split Ring Tweezers	4 1/2"	\$4.21	\$4.46	\$4.95

EZ-CRIMP™ HOOK AND EYE

Item	Order #	Metal Type	W x L	12+	6+	1+
D	24038	Sterling Silver	7.8 x 30mm	\$0.00	\$0.00	\$0.00
E	24036	Sterling Silver	7 x 33.5mm	\$26.27	\$26.80	\$28.14
F	24039	Sterling Silver	7.8 x 30mm	\$0.00	\$0.00	\$0.00

S-HOOKS

Item	Order #	Metal Type	W x L	12+	6+	1+
G	23860	Sterling Silver	7.75 x 17.75mm	\$6.25	\$6.36	\$6.65
H	23853	Sterling Silver	10.75 x 18.5mm	\$7.94	\$8.08	\$8.45
J	23822	Sterling Silver	6 x 15.5mm	\$29.51	\$30.12	\$31.65

SPRING RINGS WITH SEAMLESS OPEN RING

Item	Order #	Metal Type	Width	Ring ID	12+	6+	1+
K	SR5	Sterling Silver	5mm	1.4mm	\$1.13	\$1.15	\$1.18
	SR5	Yellow Gold Filled	5mm	1.4mm	\$1.33	\$1.37	\$1.37
L	SR5.5	Sterling Silver	5.5mm	1.1mm	\$1.26	\$1.29	\$1.32
	SR5.5	Yellow Gold Filled	5.5mm	1.1mm	\$1.11	\$1.13	\$1.13
M	SR6	Sterling Silver	6mm	1.5mm	\$1.56	\$1.59	\$1.64
	SR6	Yellow Gold Filled	6mm	1.5mm	\$2.10	\$2.15	\$2.15
N	SR7	Sterling Silver	7mm	1.4mm	\$1.94	\$1.98	\$2.03
	SR7	Yellow Gold Filled	7mm	1.4mm	\$2.35	\$2.41	\$2.41

JUMBO SPRING RINGS WITH CLOSED RING

Item	Order #	Metal Type	W x L	Ring ID	12+	6+	1+
P	22467	Sterling Silver	12.75 x 20.5mm	3.6mm	\$18.61	\$18.96	\$19.50
Q	22467	Sterling Silver	14.75 x 24.25mm	3.6mm	\$21.12	\$21.52	\$22.13
R	22467	Sterling Silver	16.5 x 25mm	3.5mm	\$23.67	\$24.12	\$24.80
S	22467	Sterling Silver	20 x 31mm	4.1mm	\$42.63	\$43.45	\$44.68

BEADING KIT

Our beading kit contains the essential tools and supplies for the beginning beader, including all the essential pliers, tools, design board, and instruction book.

Basic Beading Kit includes:

- Bead Board
- #5 Beading Tweezer
- Beading Awl
- Basic Beading Instruction Book
- 80mm Brass Gauge
- 4½" Chain Nose Pliers
- 4½" Round Nose Pliers
- 4½" Sidecutter
- Thread Scissors



Item	Order #	Description	12+	6+	1+
A	38-9022	Basic Beading Kit	\$32.47	\$34.38	\$38.20

FLOCKED BEAD BOARDS

Help in keeping design objects in place. Recessed storage bins are perfect for organizing beads, findings, and stringing material.

Item	Order #	Description	W x L	12+	6+	1+
B	38-1009	Mini-Travelers Board with Cover	7¾" x 11¼"	\$5.74	\$6.08	\$6.75
C	38-1010	U-Shaped Travelers Board with Cover	9¾" x 13¼"	\$5.82	\$6.17	\$6.85
D	38-1008	Multi-Strand Bead Board	10" x 20½"	\$9.38	\$9.79	\$10.20
E	38-1011	Bead Board with 3 Channels (6 bin)	9" x 19"	\$5.91	\$6.26	\$6.95
F	38-1007	Bead Board with 3 Channels	8" x 19"	\$7.27	\$7.70	\$8.55
G	38-1012	Bead Board	10½" x 19"	\$4.29	\$4.55	\$5.05
H	38-1005	4-Row Straight Board	8" x 21"	\$4.80	\$5.09	\$5.65

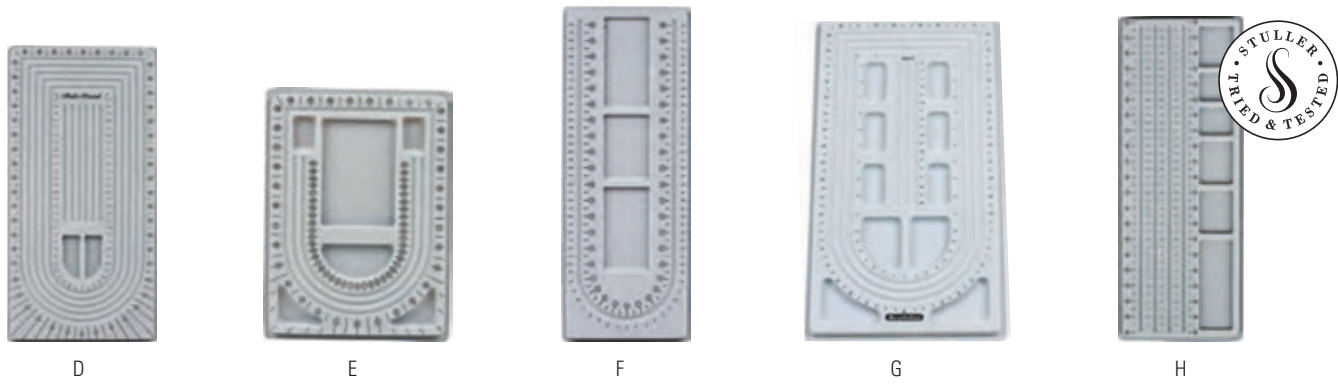
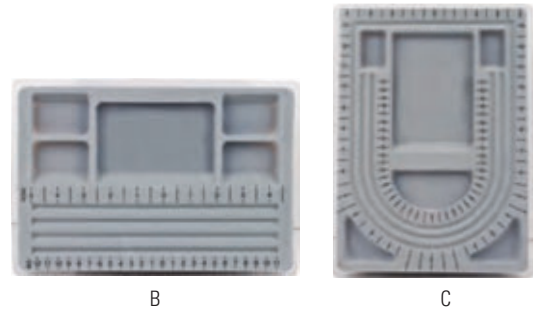

BEAD BOARD WITH CASE

The flocked gray surface reduces eyestrain and helps keep objects in place. Recessed storage bins are perfect for organizing beads, findings, and stringing materials. Graduated beading channels are essential for designing multi-strand necklaces and bracelets.

Item	Order #	Description	W x L	12+	6+	1+
J	38-1015	Bead Board with Case	9" x 19"	\$10.64	\$12.16	\$15.20
	38-1016	Case Only	9" x 19"	\$7.91	\$9.04	\$11.30



Beading and Stringing Supplies



BEAD BOARD

Use this black wood board to align beads prior to stringing. Contains grooves, which are perfectly spaced for work organization.

Order #	Description	W x L	12+	6+	1+
38-1001	Wood Stringing Board	4" x 14½"	\$6.85	\$7.43	\$8.25

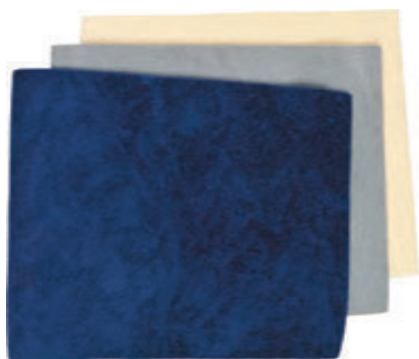

BEAD MAT

Soft comfortable bead mats keep small parts from rolling around and cushion hands while stringing beads.



Order #	Description	W x L	12+	6+	1+
38-1006	3-Piece Set: Beige Blue Gray	9" x 12"	\$2.85	\$2.98	\$3.10



PERFECT END THREAD BURNER

End the fray. Why didn't someone think of this before? Perfect for stopping frayed ends of thread on embellishments, peyote stitch, or anywhere raw ends need to be eliminated. Cuts and cauterizes. Fact is that the tip heats to red hot at the touch of a button and melts synthetic threads so that they don't unravel. Powered by one AA battery (included).

Order #	Description	12+	6+	1+
21-2603	Perfect End Thread Burner	\$23.38	\$24.75	\$27.50

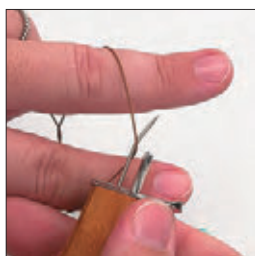

BEADALON® BEADING TOOL

The Beadalon Knotter Tool allows you to create tight, consistent knotted strands. This economy tool does the work of an awl and tweezers in one easy-to-use tool. Complete with illustrated instruction book.

Order #	Description	Length	12+	6+	1+
38-0194	Beadalon Beading Tool	5"	\$27.58	\$29.21	\$32.45

BEAD STATION

Organize your beading supplies for stringing convenience. This wood carryall features a plier bar, carded silk hooks, a place for wire and cord spools, a tabletop ruler, and a top shelf for holding miscellaneous tools, supplies, and components. Choose white silk on spools for economy and value.

Order #	Description	W x L x H	12+	6+	1+
38-9020	Station	6½" x 22" x 15"	\$38.17	\$40.41	\$44.90



All tool items shown are sold separately.

TRI-CORD™ PROFESSIONAL BEAD STRINGING

A. The professional knotting tool kit comes with everything you need to get started in the craft of classic pearl knotting, beading, and bead stringing, as well as the profitable jewelry repair industry. Just a few short hours of self-learning with the instructional DVD help provided, and your investment will quickly pay for itself.

Item	Order #	Description	12+	6+	1+
A	38-0190	Tri-Cord™ Beading Kit	\$90.11	\$94.03	\$97.95
	62-4403	Bead Stringing Instruction Booklet	\$22.68	\$23.66	\$24.65



TRI-CORD™ "TIN-CUP" KNOTTER®

B. The "Tin-Cup" knotting tool is for knotting a bead or beads and other components with a space in between each group, known as a "station" in the jewelry industry. These stations can be a single pearl with a knot on each side separated by ⅜ of an inch or more between each station. They can be any combination of components separated by the silk cord or even links of chain, creating unique artistic designs in pearl, metal, stone, and crystal beads.

TRI-CORD™ PROFESSIONAL KNOTTING TOOL®

C. Knot faster and with more consistency. The revolutionary Tri-Cord™ Knotter does the work of an awl and tweezers in one easy-to-use tool. Once your strand is started, you can string on all beads and knot quickly and continually, creating knots that are tight, consistent, and have the professional appearance your customers expect.

Item	Order #	Description	12+	6+	1+
B	38-0193	Tin-Cup Knotter	\$43.82	\$46.40	\$51.55
C	38-0192	Knotting Tool	\$38.25	\$40.50	\$45.00



B



C

STRINGING WITH THE TRI-CORD™ KNOTTER

It's fast and easy to create professional quality knots with this convenient tool. Simply make a loop, pick it up with the knotter's awl, move the knot down to the bead, and release (instructions included). You get tight, consistent knots in a fraction of the time it would take with the conventional awl-and-tweezers stringing method!

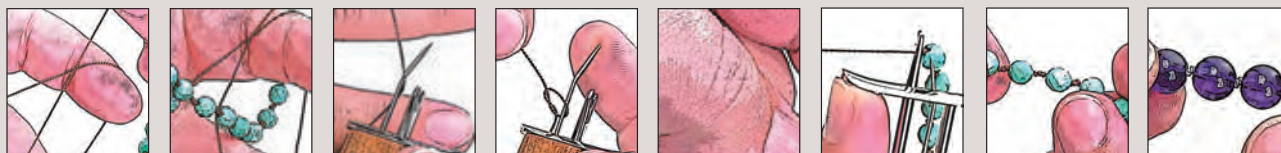

Beading and Stringing Supplies



STORAGE ORGANIZER

Handy trays for beads, clasps, and findings. Makes carrying small parts safe and easy. Clear box with hinged lid.

Item	Order #	# of Compartments	W x L x H	12+	6+	1+
A	15-2064	6 Compartments	7" x 4" x 1½"	\$1.78	\$1.94	\$2.15
B	15-2058	52 Compartments	10" x 7" x 1¾"	\$18.19	\$19.26	\$21.40



ORGANIZATION TRAYS AND VIALS

Durable, clear plastic storage boxes with fixed compartments.

Order #	# of Compartments	W x L x H	6+	3+	1+
15-2066	18 Compartments	8¼" x 1¼" x 4¼"	\$5.81	\$6.19	\$6.45
15-2067	12 Compartments	8¼" x 1¼" x 4¼"	\$5.81	\$6.19	\$6.45
15-2068	18 Compartments	11" x 1¾" x 6½"	\$8.28	\$8.37	\$8.45
15-2069	36 Compartments	10" x 1½" x 7"	\$9.26	\$9.36	\$9.45



STACK DRAWERS

Fill these handy drawers with all different types of findings, stringing materials, solder chips, and anything else needed for different jobs. Then when it's time to do the job, simply get the drawers of product you need, attach them together, and all the supplies stay neatly organized. Kit includes 10 drawer units that connect in two different directions, side to side or top to bottom.

Order #	W x L	12+	6+	1+
15-2059	1" x 1¾"	\$4.29	\$4.55	\$5.05



ORGANIZATION TRAYS AND VIALS

High-impact, plastic utility boxes are convenient for storing small items. Adjustable partitions are removable and allow for a variety of compartment sizes. Contents are easily identified with see through lid, which securely snaps closed.

Order #	# of Compartments	W x L x H	6+	3+	1+
15-2060	6 Compartments	4½" x 1½" x 3"	\$2.21	\$2.35	\$2.45
15-2061	3-15 Compartments	8¾" x 1¾" x 5"	\$5.67	\$6.05	\$6.30
15-2062	5-15 Compartments	11" x 2½" x 7"	\$8.06	\$8.59	\$8.95



A



B



C



D

ORGANIZATION TRAYS AND VIALS

Paper-covered trays with magnetic closure and clear view lid. Vials have swing-top lids.
 Small Bottle: 6mm hole
 Large Bottle: 10mm hole

Item	Order #	Description	W x L x H	6+	3+	1+
A	59-2105	Black Tray (36 black vials)	6" x 9½" x 1"	\$17.91	\$19.10	\$19.90
B	59-2115	Black Tray (24 lime green vials)	5¾" x 10¼" x 1¼"	\$22.98	\$23.47	\$24.45
C	59-2100	Small Plastic Vial with Black Lid	½" x 1½"	\$0.54	\$0.58	\$0.60
D	59-2110	Large Plastic Vial with Lime Green Lid	⅞" x ½"	\$0.86	\$0.91	\$0.95

STACKABLE ROUND TRAYS

These convenient and space-saving trays have threaded bottoms that securely screw to the tray below, allowing access to any tray at any level. Translucent plastic.

Item	Order #	Diameter	Per Pack	12+	6+	1+
E	38-9006	2"	6	\$3.27	\$3.47	\$3.85
F	38-9008	1¼"	6	\$2.47	\$2.61	\$2.90



E



F

ORGANIZATION TRAYS AND VIALS

Light blue plastic tray with slide lid that allows for smooth opening and closing operations and keeps parts in place. A wide variety of parts and small objects can be stored. The front edge of each compartment is rounded, making the contents easily retrievable.

Item	Order #	# of Compartments	W x L x H	6+	3+	1+
G	15-2070	18 Compartments	10½" x 6¾" x 1½"	\$9.00	\$9.60	\$10.00
H	15-2071	24 Compartments	7¾" x 5" x 1"	\$9.00	\$9.60	\$10.00



G

H

The Best Tool You Need To Build Your Business



We've designed Bench Jeweler Workshop to be educational, entertaining, and value-packed with discounted products. Students, first-time attendees, and industry veterans alike can learn more about the craft of jewelry-making and repair. Bench Jeweler Workshop is the industry's best opportunity for bench jewelers and store owners to learn from fellow craftsmen and tools experts.

TALK *it out*

Talk one-on-one with Tools Team experts and network with fellow bench jewelers to improve your skills

TRY *it out*

Interactive classes and hands-on instruction featuring some of the newest tools and technology in the industry

WORK *it out*

Exclusive show specials on items that will help you continue to grow your education at home in your own shop

For more information, log on to BenchJeweler.com/Workshop.

BenchJEWELER
— WORKSHOP —

powered by  STULLER

PRO ELECTRIC BEAD REAMER

Compact, lightweight design makes it perfect for smoothing rough edges of beads and enlarging bead holes. Includes 3 diamond-coated tips: small reamer, large reamer and 45° edge reamer. Variable speed control: 1,000–20,000 rpm. 24V DC.

Item	Order #	Description	12+	6+	1+
A	38-9019	Motorized Bead Reamer	\$19.98	\$21.15	\$23.50
B	53-0201	Short Tip	\$1.83	\$1.94	\$2.15
C	53-0202	Long Tip	\$1.83	\$1.94	\$2.15
D	53-0203	45° Diamond Tip	\$1.83	\$1.94	\$2.15



BATTERY-OPERATED BEAD REAMER

This bead reamer is designed to enlarge holes in pearls, gemstones, and other beads. Simply submerge the bead and reamer tip into a small amount of water and apply to the bead hole. Sold with two tips; batteries not included.

Item	Order #	Description	12+	6+	1+
E	38-3101	Battery-Operated Bead Reamer	\$22.48	\$23.81	\$26.45
F	38-3102	Replacement Tips (pack of 2)	\$4.68	\$4.95	\$5.50

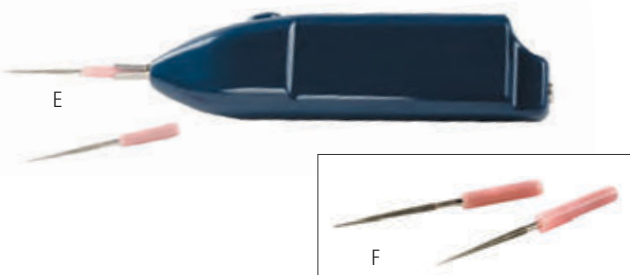

DELUXE BEAD REAMER

Diamond Bead Reamer Set. Includes three points (small and large reaming points, plus 45° edge reamer). Handle is hollow so you won't lose the diamond points, just store them in the handle. Easy-release chuck fits into the aluminum housing so it releases instantly when the collect is unscrewed. Handle is anodized aluminum with a cushion PVC grip for comfort. Chuck is brass so rust is never a problem.

Item	Order #	Description	12+	6+	1+
G	53-0200	Bead Reamer Set with Comfort Grip	\$15.85	\$16.79	\$18.65
H	53-0201	Short Tip	\$1.83	\$1.94	\$2.15
J	53-0202	Long Tip	\$1.83	\$1.94	\$2.15
K	53-0203	45° Diamond Tip	\$1.83	\$1.94	\$2.15

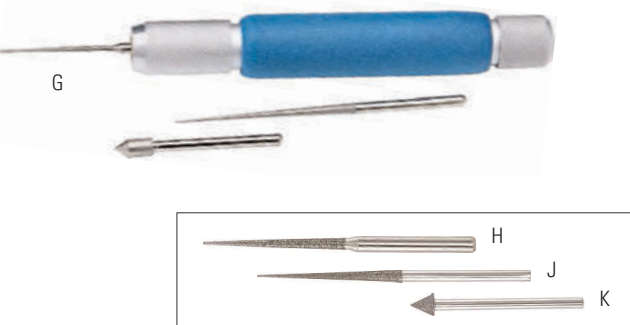

BEADING AWL DESIGNER WITH PVC GRIP

Deluxe rubberized handle helps control tip placement. Great for hand knotting and opening small beads for covering crimps.

Order #	Length	12+	6+	1+
38-3100	5¾"	\$5.78	\$6.12	\$6.80



STRINGING AWL

Designed to slide a knot down into the bead tip or between two beads. Can also be used for cleaning holes.

Order #	Description	12+	6+	1+
38-3300	Stringing Awl (Brass)	\$2.81	\$2.97	\$3.30



WOOD BEAD HOLDER

A handy tool for bead stringing. This wooden vise securely holds delicate beads while cleaning or reaming holes.

Order #	Length	12+	6+	1+
53-0215	6¾"	\$5.61	\$5.94	\$6.60



Beading and Stringing Supplies



PATTERN #7 TWEEZERS

Pattern #7 - Excellent for handling all miniature and micro-miniature parts and components. Curved shanks have beveled edges and points are very sharp with a plain finish.

Order #	Description	Length	12+	6+	1+
57-0420	Dumont® II Stainless Steel	4½"	\$34.00	\$36.00	\$40.00



PATTERN #5 BEAD TWEEZERS

Pattern #5 - Used for handling microscopic parts and delicate knotting work. Has very narrow, needle-like points honed to extreme sharpness. Shanks are indented with beveled edges. Non-magnetic.

Order #	Description	Length	12+	6+	1+
57-5030	Dumont® II Stainless Steel	4½"	\$28.05	\$29.70	\$33.00



PEARL-HOLDING TWEEZERS

Used to hold pearls. Tips are epoxy coated and will not damage pearls.

Order #	Description	Length	12+	6+	1+
57-6013	Holding Tweezers	5¾"	\$10.16	\$10.76	\$11.95



DIAMOND TWEEZER WITH SCOOP

Fine serrated points, ribbed shanks.

Order #	Description	Length	12+	6+	1+
57-7660	Tweezers with Scoop	7"	\$3.36	\$3.56	\$3.95



ECONOMY TOOL KIT

This economy tool kit with zip pouch comes complete with all the tools you need to begin beading. It features chain nose pliers, round nose pliers, wire cutters, tweezers, a bead scoop, snips, and six modular and stackable drawers, all zipped into a handy storage pouch. The complete kit is ready to travel and keeps tools neatly organized. Store various findings and beads in the drawers.



Order #	Description	12+	6+	1+
46-0516	7-Piece Repair Kit	\$13.09	\$13.86	\$15.40



MINI TOOL KIT

The perfect set of mini tools for quick repairs and for travel. Contains all the tools necessary for wire wrapping and other stringing functions. These mini tools are 3" long. Set is complete with chain nose pliers, round nose pliers, flat nose pliers, fiber tipped pliers, and a cutter, all zipped up into the blue pouch.



Order #	Description	12+	6+	1+
46-0515	5-Piece Repair Kit	\$11.22	\$11.88	\$13.20

EURO CRIMPER

Incorporates two medium crimping cavities to fit all of the crimp tubes and beads within the medium range. Each cavity is slightly larger (or smaller) than the other to give the user the ability to tighten the crimp properly. Great on Beadalon #1 and #2 Crimp Beads or #2 Crimp Tubes, as well as other non-standard crimp bead and tube sizes.



Order #	Description	Length	12+	6+	1+
46-3995	Crimping Plier	5"	\$14.03	\$14.85	\$16.50

THE #1 CONNER BEAD SETTING PLIERS

The right tool for securing Beadalon #1 Crimp Tubes and sizes #0 and #1 Crimp Beads. Use one firm squeeze to crimp with the inner-position grooves, then use the outer-position grooves to round off the crimp. The jaw grooves are comparably smaller to make a dependable closure on smaller crimp findings.



Order #	Description	Length	12+	6+	1+
46-4007	Crimping Plier	5"	\$11.90	\$12.60	\$14.00

MICRO CRIMPER

Close and secure Beadalon Crimp Beads and Crimp Tubes with this easy-touse hand tool. Inner-position grooves crimp beads and tubes tightly closed with one firm grip; outer-position grooves round off edges on Crimp Beads for a smooth, professional result. Use with Beadalon #1 and #2 Crimp Beads or #2 Crimp Tubes.



Order #	Description	Length	12+	6+	1+
46-4005	Crimping Plier	5"	\$11.18	\$11.84	\$13.15

MICRO FLUSH CUTTER DELUXE

Secure larger Beadalon #3 Crimp Beads or #3 or #4 Crimp Tubes with this specially sized crimper tool. Larger surface area provides a full crimp on bigger components without compromising the professional, finished look.



Order #	Description	Length	12+	6+	1+
46-4008	Crimping Plier	5"	\$10.63	\$11.25	\$12.50

POWER MAX CUTTERS

Designed to fit exclusive Beadalon EZ-Crimp™ Ends. Simply navigate the EZ-Crimp End into the jaws with the smooth part of the end in the curved tip of the jaw. Next, squeeze completely and repeat if necessary on the full length of the EZ-Crimp End. The connection with the wire is now complete.



Order #	Description	Length	12+	6+	1+
46-4018	Crimping Plier	5"	\$13.13	\$13.91	\$15.45

Beading and Stringing Supplies



FOUR-IN-ONE PLIERS

This plier is our Four-In-One “Beader’s Delight.” A must for wire wrappers. This plier has a finely tapered long nose for coiling; a flat jaw for flattening, straightening, or bending; a groove for closing coils and jump rings; and a sidecutter. Great for travel with PVC grips and double-leaf springs.

Order #	Description	Length	12+	6+	1+
46-4017	Beading Plier	5"	\$9.35	\$9.90	\$11.00



MICRO-MINI BEAD KNOT PLIERS

This pair of pliers is used when knotting bead cord, as knotted cord slides off of this finely tapered nose. These pliers are easier to use than tweezers, especially when using heavier bead cord.

Order #	Description	Length	12+	6+	1+
46-4006	Beading Plier	5"	\$8.80	\$9.32	\$10.35

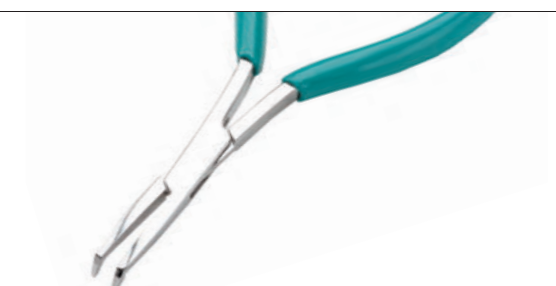

MICRO MINI/FLAT NOSE PLIERS

Use these reasonably priced stainless steel pliers for delicate tasks.

Order #	Description	Length	12+	6+	1+
46-9003	Flat Nose Plier	5"	\$6.12	\$6.48	\$7.20



XURON® HIGH PRECISION SCISSORS

Ultra-precise, the Xuron™ scissor cuts fine or delicate items with a clean, square edge cut. Cushion grips and return spring provide increased comfort and precision. Rated for cutting soft metals up to 0.005". Including materials such as silk, embroidery, floss, or thin mylars.

Order #	Description	Length	Jaw Length	12+	6+	1+
46-0508	Scissor	5"	0.47"	\$14.96	\$15.84	\$17.60



XURON® HIGH DURABILITY SCISSORS

Features precision ground high carbon steel cutting edges. Excellent for cutting solder and sheets of light gauge metal up to 0.030" (0.8mm). For line and all bead cords, these pliers have serrations on one edge to keep material secure while cutting.

Order #	Description	Length	Jaw Length	12+	6+	1+
46-0513	Scissor	6"	0.85"	\$18.70	\$19.80	\$22.00



PRECISION SCISSORS

Used for beading and other delicate work. Handles are large and made of black ABS. Small, pointed blades are made of high quality stainless steel. Blades are held together with a stainless steel high-impact rivet and nylon washer, which provide smooth cutting and extended life.

Order #	Description	Length	12+	6+	1+
53-6200	Beading Scissor	4"	\$11.05	\$11.70	\$13.00

MICRO-SNIP BEADING SHEAR

Ideal for bead string and thread snipping.

Order #	Description	Length	12+	6+	1+
53-2800	Shear	3½"	\$3.74	\$3.96	\$4.40



BEADALON® SNIPPER TOOL

These compact snips have precision tips to make close cuts easy. Built for efficiency, these new snips look good and can cut silk cord, nylon, nymo, and most other non-metal stringing materials with ease. Always-ready blades are extremely sharp and hold their edge. The secure blade cover prevents accidental holes.

Order #	Description	Length	12+	6+	1+
53-2801	Snipper	4½"	\$3.40	\$3.60	\$4.00



FULL FLUSH CUTTER

These cutters are specifically designed for multi-strand beading wire and full-flush with jaws induction hardened to 60-62 Rockwell. Used properly, this degree of hardness assures a clean cut, time after time. Cutting edges are precisely aligned and the black oxide non-glare head has a "relieved" design for reaching into tight areas. This quality German cutter also features double-leaf spring and yellow PVC handles. Use on flexible beading wire and soft wire only.

Order #	Description	Length	12+	6+	1+
46-4013	Cutter	4½"	\$21.25	\$22.50	\$25.00
46-4014	Pointed Jaw Cutter	4½"	\$26.35	\$27.90	\$31.00



JUMP RING MAKER WITH MANDRELS

Pepetools Jump Ring Maker employs the use of a keyless chuck for securing the inner Jump Ring core rod. The Jump Ring Maker is supplied with 20 inner core rods which range in size from 2.5mm to 12.5mm in ½mm increments. Wire is coiled on the core rods and placed in the coil holder and cut with a Foredom flexshaft tool with a No. 30 hand piece.

Order #	Description	OD	12+	6+	1+
28-2040	Jump Ring Maker		\$157.25	\$166.50	\$185.00
28-2043	Replacement Blade	1¼"	\$11.26	\$11.93	\$13.25
28-2043	Replacement Blade	1½"	\$14.07	\$14.90	\$16.55



WATCHMAKER'S BENCH

Our Stuller custom Watchmaker's bench is made in the USA with a solid Gibraltar top that is routed along the edge to prevent parts from rolling away. This red oak fully skirted bench features a 15" steel lined catch drawer with a removable leather insert. Eight graduated drawers include one lockable and dividable small parts drawer, with six bank drawers, one 6' D x 2 7/8" H tool holder, and also includes one center roll out work surface.

Benches and Bench Tools



Large satin nickel pulls give it a modern look while improving function. This bench comes equipped with a quality version of the classic watchmakers vise suitable for precision work. Only the base secures into the bench surface. This vise can be quickly removed from its mounting base by sliding a lever back that reattaches quickly by sliding the lever forward. The European arm rests are

tilted, adjustable, upholstered, and padded in brown imitation leather to keep you really comfortable. Special ergonomic shape prevents fatigue at the bench and makes it really easy to work. Inlaid bushing for Dazor® lamps on either side of the bench. Ships completely assembled by truck freight.



Find added video content on Stuller.com.



Item	Order #	Description	W x H x D	1+
A	13-0441	Watchmaker's Bench	60" x 44" x 24"	\$3,800.00
ACCESSORIES				
B	58-2436	Bergeon Vise with Detachable Vise		\$385.90
C	13-1823	Bushing		\$26.25
D	13-0530	Adjustable Armrests		\$1,150.00

IDEAL BENCH

Designed to be the only bench you'll need. This fully assembled, 10 drawer, solid wood jeweler's bench features easy-to-slide drawers complete with a convenient contoured, steel lined filing drawer, a removable small parts/watchmaker's mat, storage cabinets with plier holder, an oversized Gibraltar top with a GRS® mounting adaptor plate inlaid, and pre-drilled mandrel holes. Purchase the best value in the industry today. Special order a customized bench. The width of this bench can be suited to the individual's needs. Choose a width from 46" up to 60". The depth and height should not be altered. However, drawer sizes will change. Made of solid wood in the USA. Benches ship fully assembled by motor freight only.

Order #	W x H x D	1+
13-0442	52" x 48" x 23½"	\$2,160.00



Find added video content on Stuller.com.

SPECIAL FEATURES

Inlaid Mount Plate



Pliers Rack



Contoured Drawer

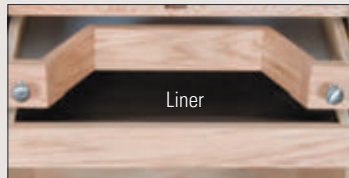

Liner



Steel-Lined Drawer



Pullout shelf on each side.
Brushed-steel handles.

JEWELER'S WORKBENCH

Well-constructed, all wood with hardwood top, jeweler's workbench. Consists of three drawers on the right-hand side, a pullout utility tray with two shelves, full skirted legs and back, two arm rests, steel-lined drawer pan, and pre-drilled mandrel holes. No assembly required. Made of solid wood in the USA.

Order #	W x H x D	1+
13-0430	38¾" x 39" x 19¼"	\$495.00

SPECIAL FEATURES

Steel-Lined Drawer



Butcher Block Top



Pullout Shelf







HARDWOOD WORK TABLE WITH LOWER SHELF
 Made from hardwood, this work table is ideal for use as a metal forming table or as a polishing table. Assembly required.

Order #	W x H x D	1+
13-0446	68 1/4" x 37 3/4" x 21 1/2"	\$495.00



HARDWOOD WORK TABLE WITH 1 DRAWER
 Made from hardwood, this work table is ideal for use as a metal forming table or as a polishing table. Assembly required.

Order #	W x H x D	1+
13-0447	60" x 32 1/4" x 25 1/4"	\$395.00



SMALL HARDWOOD WORK TABLE
 Made from hardwood, this small work table is ideal for use next to your bench. Assembly required.

Order #	W x H x D	1+
13-0448	32 1/2" x 25 1/2" x 15 3/4"	\$166.50



HARDWOOD WORK TABLE WITH OVERHEAD TOOL ORGANIZER

Made from hardwood, this work table is ideal for metal forming or any other type of fabricating. No assembly required.

Order #	W x H x D	1+
13-0445	44½" x 47¼" x 27½"	\$468.00

SPECIAL FEATURES

Built in Organizers



Folds to Save Space



JEWELER'S WORK BENCH

Don't settle for imitations...Buy a genuine, solid wood, heavy-duty bench! Solid all-wood bench; no pressboard and no particle board. Solid wood top with all wood legs and full skirt. Three utility drawers assembled. Pull-out tray with two shelves. Two-arm rests and a lined catch drawer.

Order #	W x H x D	1+
13-0449	39" x 39" x 19½"	\$299.00

SPECIAL FEATURES

Three Utility Drawers



Pullout Tray with 2 Shelves



Lined Catch Drawer



Two arm rests





MADE BY STULLER IN THE USA

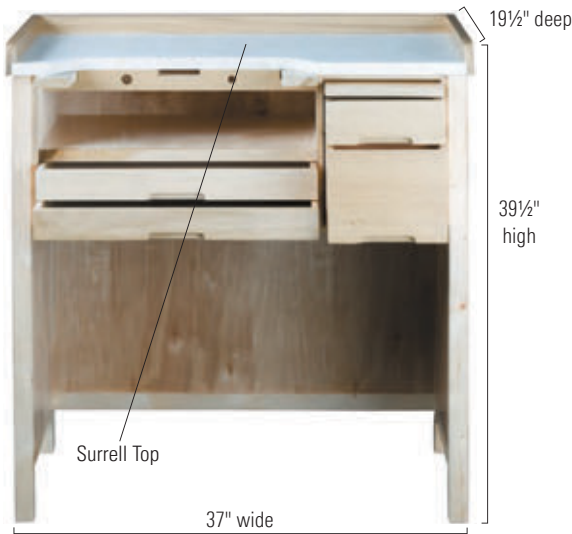

JEWELER'S BENCH WITH SURRELL SURFACE

All-wood constructed workbench with a solid Surrell, heat-resistant, easy to maintain work surface. Light sanding will remove burns, stains, or minor scratches. Fully-skirted, quality hardwood construction will withstand the rigors of daily use. Other features include two side drawers and two arm rests. No assembly required. Made of solid wood in the USA.

Order #	W x H x D	1+
13-0436	37" x 39½" x 19½"	\$695.00



Benches and Bench Tools



CUSTOM DELUXE JEWELER'S WORKBENCH

This deluxe bench is made of top-quality, wood materials and constructed to handle the demands of daily use. The solid ¾" hardwood work surface is complemented by 16 drawers, two armrests, and a pullout tray. Solid side and back panels provide long-lasting support. No assembly required.

Order #	W x H x D	1+
13-0434	40" x 40¾" x 24½"	\$1,049.00

SPECIAL FEATURES

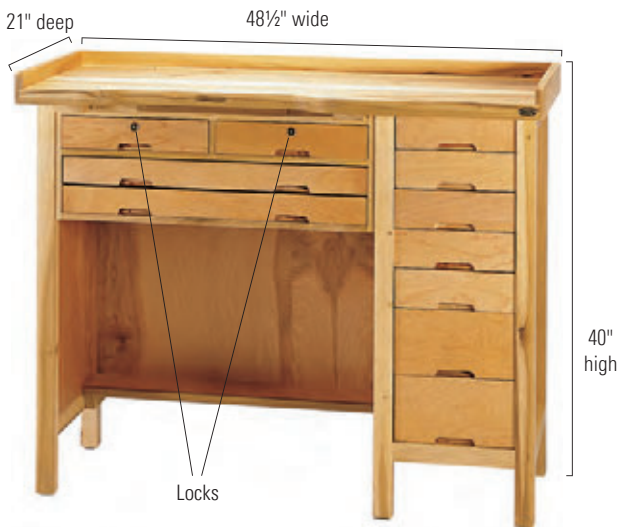
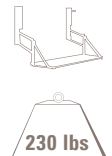

PREMIER WORKBENCH

Well-crafted, all-wood bench that is built to last. Has a solid hardwood work surface with reinforced side railings and full skirted sides and rear. Features seven side drawers, two top drawers with security locks, one formica-lined drawer, three steel-lined drawers, "catch" drawers, right and left arm rests, slot for bench pin, and layout shelf. No assembly required. Made of solid wood in the USA.

Order #	W x H x D	1+
13-0438	48½" x 40" x 21"	\$999.00

SPECIAL FEATURES

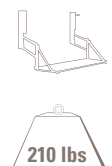

SHELFMATE TOOL HOLDER

Keep your tools handy and organized while increasing your workspace. Store pliers, shears, and other tools within reach. Easy to assemble instructions included.

Item	Order #	W x H x D	1+
A	13-0460	35" x 17" x 7"	\$59.95

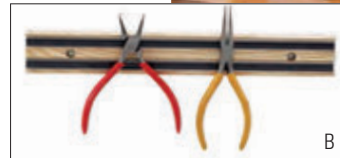
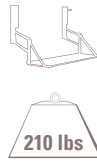

MAGNETIC TOOL HOLDER

Pliers, screwdrivers, and other miscellaneous metal tools are held securely in place with permanent magnets. Mounts with screws.

Item	Order #	Length	1+
B	13-3800	12"	\$21.40

WOODEN PLIERS CABINET

Ideal for hobbyists, jewelers, or watch makers to place on work bench. Holds seven pliers, a shelf for tools, and a storage drawer.

Order #	W x H x D	1+
13-3760	6½" x 5" x 7½"	\$15.75



BENCH TOP ORGANIZER

Fits perfectly on the back of a bench or a work table. Contains space for findings, tools, and accessories and organizes it all. Four drawers are included for stowaway items. A great compliment to any work area.

Order #	W x L x H	1+
13-3765	5" x 18" x 3½"	\$51.75



MANDREL AND HAMMER ORGANIZER

Can be attached to a work bench.

Order #	W x H x D	1+
13-3766	18" x 6½" x 7"	\$66.35



WOODEN PLIERS RACK

Has slots for seven pliers, a shelf for small tools, and a handy storage drawer in a natural, varnished finish.

Order #	W x H x D	1+
13-3771	7" x 3¾" x 7½"	\$21.80





JEWELER'S BENCH CHAIR

Ergonomic bench chair designed for jewelers and watchmakers. Specially constructed to provide years of comfort while greatly improving productivity and reducing fatigue. Single touch adjustments provide independent control of the seat, backrest, and lumbar height. Soft durahyde vinyl keeps you cool and comfortable.

Item	Order #	Description	Height	1+
A	13-0510	Jeweler's Chair	16 - 21¼"	\$439.90



AUTOFIT JEWELER'S CHAIR

Sitmatic's AutoFit, the first auto-tensioning chair with a reclining seat. Before AutoFit, chairs that auto tensioned had to have seats that pitched forward to counterbalance the user. AutoFit's unique design promotes a healthy lumbar by keeping the user in constant contact with the backrest throughout their range of motion. Not only a dedicated task chair, AutoFit has natural applications in conference and 24-hour settings where chairs are rarely adjusted.

Item	Order #	Description	Height	1+
B	13-0511	Autofit Jeweler's Chair	21"	\$489.00
C	13-0512	Autofit Jeweler's Chair without Arms	21"	\$459.95



Find added video content on Stuller.com.

SADDLE SEAT

This deceptively comfortable setter's seat is a thoroughly ergonomic design. It adjusts the hips and knees to a 135° angle rather than the 90° angle of a traditional chair. It is fully adjustable to suit the user's height and tilt preferences, and will create healthier feeling back, neck, and legs.

Item	Order #	Description	Height	1+
D	13-0517	Saddle Seat	35"	\$299.00



Back



SETTER'S CHAIR

Ergonomic jewelers' chair designed to provide comfort and reduce fatigue. Single touch adjustments provide independent control of the seat, backrest, and lumbar height. The seat is adjustable from 16" to 21" by a convenient foot control.

Item	Order #	Description	Height	1+
E	13-0516	Setter's Chair	37"	\$295.00



Back



EARRING SETTING TOOL

This unique earring setting tool allows you to keep a good grip on a basket earring during the setting process. This tool is made of light weight aluminum and brass and has a .43mm x 1/2" deep hole for the earring post to sit in. The Earring Setting Tool is easy to use. First, place the earring into the hole in the fixture, then tighten the brass knob which will close the brass jaws and secure the earring. Now you are ready to set your earring.

Order #	Description	1+
53-0601	Earring Setting Tool	\$38.00



Find added video content on Stuller.com.

SPECIAL FEATURES

Insert Post for Earring



Brass Claws for Securing Earring Basket



Knob to Tighten the Claws

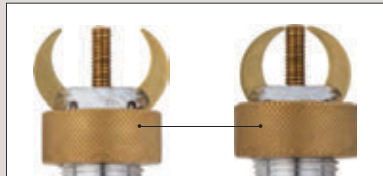

Mounting Height Adjustment Knob



RING SETTING TOOL

The Stuller exclusive Ring Setting Tool was created by a master jeweler. The kit comes complete with two fixtures, two sets of nine interchangeable dies, knobs, and allen wrenches for tightening the collets. Using this tool is very easy. First choose the correct collet size to fit inside the ring. Next, place the ring over the collet and then snug the ring up by using the provided allen wrench or knob. Once the ring is secure, place the fixture into your mini or standard engraving ball and you are ready to channel set, bead set, or engrave. The angled fixture allows you to change the angle of your working surface for easier setting or engraving. The straight edged fixture allows you to mount your rings with the lap area of the ring exposed to aid in the process of engraving and setting stones on side of the shank.

Order #	Description	1+
53-0603	Ring Setting Tool	\$96.90



Cone Collet Mounts



Find added video content on Stuller.com.

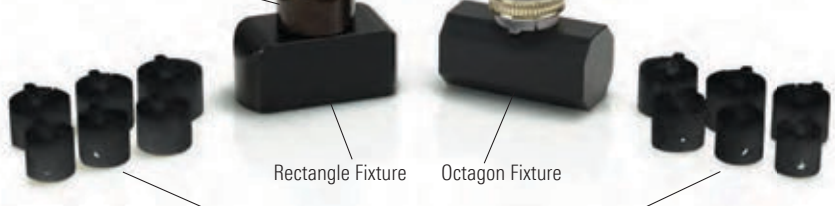

Rectangle Fixture Octagon Fixture

Expandable Collets





A



B



C



D

GRS® BENCHMATE™ ACCESSORIES

BenchMate™ is a versatile work-holding system for a full range of jewelry work. BenchMate™ multiplies the force of your hands using the principles of leverage. You will work with reduced muscular strain and force. BenchMate™ tilts and rotates freely to any position. You can also lock the BenchMate™ in virtually any position. This feature helps eliminate the possibility of damaging your work or injuring yourself in case of an accidental slip.

BASIC PACKAGE

A. Includes: BenchMate™, shellac pad, fixed mounting plate, and hardware.

DELUXE PACKAGE

B. Includes: BenchMate™, shellac pad, narrow solder clamp, wide solder clamp, third hand attachment, bench pin kit, fixed mounting plate, and hardware.

PLUS PACKAGE

C. Includes: BenchMate™, shellac pad, narrow solder clamp, wide solder clamp, two third-hand attachments, bench pin kit, four-inch solder station, fixed mounting plate, and hardware. Right-handed use only. Left-hand saw plate may be special ordered for left-handed users.

SETTER'S PACKAGE

D. Includes basic BenchMate™ holder, shellac pad, bench pin kit, inside ring holder, fixed mounting plate, and hardware.

Item	Order #	Description	Assortment Qty	1+
A	26-4100	Basic Package	Each	\$237.15
B	26-4101	Deluxe Package	Each	\$321.40
C	26-4102	Plus Package	Each	\$383.80
D	26-4099	Setter's Package	Each	\$341.15

ACCESSORIES

E	26-4103	Knob Assembly	Each	\$3.10
F	26-4107	Fixed Mounting Plate	Each	\$19.80
G	26-4120	Jaw Inserts	5 Pairs	\$7.70
H	26-4158	Sawing Plate Right-Handed	Each	\$31.90
J	26-4159	Sawing Plate Left-Handed	Each	\$35.20
K	26-4125	Inside Ring Holder with 7 Collets	Set	\$87.10
L	26-4148	Replacement 7 Collet Set	Set	\$44.05
	26-4126	Replacement Thumb Screw		\$1.05



E



F



G



H



J



K



L

GRS® ID RING HOLDER

Takes ring fixtures to a new level. The expansion cones assure equal pressure on both sides of the mandrel as it grips the inside diameter of the ring. When using the standard cone, the ring drag can be set to allow smooth rotation of the work-piece while setting stones or engraving the ring surface. Includes a set of 10 mandrels and all tooling.



Find added video content on Stuller.com.

Order #	Description	12+	6+	1+
26-4182	Ring Holder	\$56.14	\$59.45	\$66.05

RING SETTERS INSIDE CLAMP

This unique tool allows you to access the entire circumference of your ring. Includes nine plastic sleeve inserts marked clearly in U.S. sizes from 2-13 and in millimeter sizes 13-22. Firmly grips ring from the inside without marking, which allows you to work on the outside of the ring. Smooth hardwood handle for comfortable hand-held operations. Packaged in a hardwood box.



Order #	Description	12+	6+	1+
48-1350	Inside Ring Clamp Set	\$27.71	\$29.34	\$32.60

GRS® BENCH PIN KIT

Wooden bench pin with holder. (Does not include mounting plate.)

Item	Order #	Description	12+	6+	1+
A	26-4114	Bench Pin Kit	\$27.12	\$28.71	\$31.90
	13-3000	Replacement Pin	\$2.55	\$2.70	\$3.00
	26-4107	Fixed Mounting Plate	\$16.83	\$17.82	\$19.80



BENCH PIN IN METAL HOLDER

Easily screws to the edge of the workbench. Thumbscrew locks bench pin securely in place. Measures 4".



Order #	Description	12+	6+	1+
13-3200	Bench Vise	\$7.61	\$8.06	\$8.95

BENCH SUCTION PIN

This unique bench pin allows you to cut, grind, and polish without debris flying through the air. Attach your 2" hose from your Quatro basic or Quatro gold vault to the flange located on the bottom of the bench pin and watch the debris go down the hose and into your dust collector.

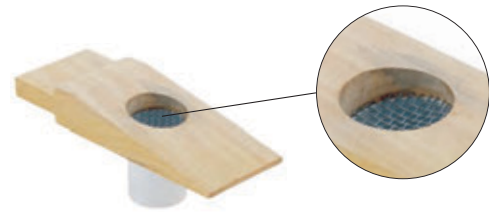

Order #	Description	12+	6+	1+
47-4122	Suction Pin	\$33.15	\$35.10	\$39.00

WOOD BENCH PINS

Fits into slot in workbench. Used as support when filing, sawing, and setting.

Item	Order #	W x L x H	12+	6+	1+
B	13-3000	2 1/4" x 5" x 1 1/4"	\$2.55	\$2.70	\$3.00
C	13-3001	2 1/2" x 6 1/2" x 1/4"	\$2.76	\$2.93	\$3.25
D	13-3002	2 1/2" x 7" x 1/4"	\$3.53	\$3.74	\$4.15

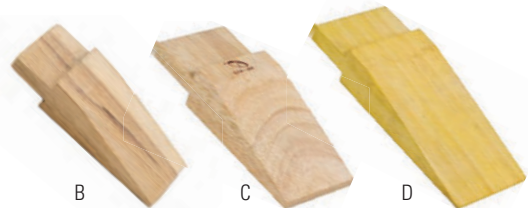

COMBINATION BENCH PIN AND ANVIL

Used to support pieces being flattened and for layout work. Combination polished steel anvil and wood bench pin measures 1 3/4" and 4". Flat anvil is smoothly finished. Adjustable clamp allows use on benches up to 2" thick.

Item	Order #	Description	W x L x H	12+	6+	1+
E	13-3205	Combo Bench Pin and Anvil	1 3/4" x 4" x 2"	\$14.03	\$14.85	\$16.50
F	13-3207	Extra Bench Pins	1 3/4" x 4" x 2"	\$2.34	\$2.48	\$2.75

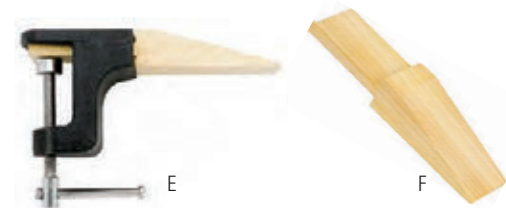

Bench Tools



THE PEG ASSIST

The PEG ASSIST™ by Jay Whaley is a Premium Ring Clamp with improved features such as:

- Non-slip, extra-long round peg.
- Quality leather-lined jaws.
- Ideal shape for secure hold.
- Clamp length: 6"; Peg length: 4¾".
- Patent pending.

Order #	Description	12+	6+	1+
48-4000	Peg Assist Ring Clamp	\$11.01	\$11.66	\$12.95



BENCH PIN FOR RINGS

Specially shaped to hold rings. Also has a slot and a channel for saw blade. Easily attaches to top of bench.

Order #	W x L x H	12+	6+	1+
13-3030	½" x 5½" x ¾"	\$3.83	\$4.05	\$4.50



A



B



C



D

BENCH CLAMPS

Ring clamps are standard fare for the bench jeweler. Stuller is proud to offer a great selection of quality ring clamps to meet the needs of our valued customers.

Item	Order #	Description	12+	6+	1+
A	48-1000	Hardwood Ring Clamp Double Leather Lined	\$5.61	\$5.94	\$6.60
B	48-1020	Mahogany Ring Clamp Double Leather Lined	\$5.91	\$6.26	\$6.95
C	48-1010	Plastic Ring Clamp (Nylon) Double Leather Lined	\$7.61	\$8.06	\$8.95
D	48-1067	Wood Ring Holding Clamp Grooved Slot Holder 8" Length	\$5.19	\$5.49	\$6.10
E	48-1034	Wood Ring Clamp	\$5.53	\$5.85	\$6.50
F	48-1035	Wood Inside Ring Vise	\$5.91	\$6.26	\$6.95
G	48-1032	Euro-Style Ring Clamp	\$7.61	\$8.06	\$8.95

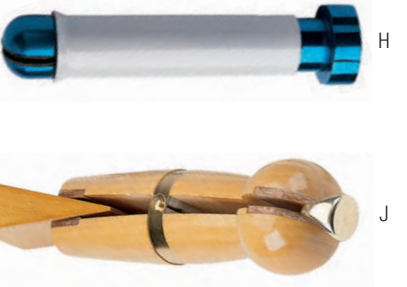

H

J

BENCH RING CLAMPS

Item	Order #	Description	12+	6+	1+
H	48-1065	Ring Clamp Cast Anodized Aluminum	\$25.29	\$26.78	\$29.75
J	48-1041	Large Head Ring Clamp 6¼" Round Head	\$7.27	\$7.70	\$8.55

**DELUXE PRONG LIFTER**

Precision tool made of steel. Rockwell hardness of 57-59. Extra-sharp, long-lasting edges.

Order #	W x L	12+	6+	1+
53-1442	¼" x 3¾"	\$12.58	\$13.32	\$14.80

**KIRKLAND RING CLAMP HOLDER**

Used for polishing the inside and outside of rings. One end clamps from the outside for polishing and stone setting. The other end holds the ring from the inside for total circumference polishing and buffing. Heat is conducted away from the ring due to the metal construction. Accommodates ring sizes 1-13.

Order #	Length	12+	6+	1+
48-1050	5½"	\$15.26	\$16.16	\$17.95

**KIRKLAND EXTERNAL RING CLAMP**

Made of cast aluminum. Holds a ring externally, which allows the inside to be filed, ground, or polished. Jaws are slightly concave and lined with thick leather so they will not scratch gold, silver, or other precious metals.

Order #	Length	12+	6+	1+
48-1060	6"	\$22.10	\$23.40	\$26.00

**PRONG PUSHER**

Used for pushing prongs or crown points around stones. Made of steel and mounted in wood handle.

Order #	Length	12+	6+	1+
53-1406	3½"	\$2.81	\$2.97	\$3.30

**BEZEL PUSHER**

Used for pushing and rolling bezels around stones. Grooved steel mounted in wood handle.

Order #	Length	12+	6+	1+
53-1400	3¾"	\$8.46	\$8.96	\$9.95

**BEZEL ROLLER**

Used for rolling bezels around stones in rings, pendants, and brooches. Half-round, highly polished steel head with wood handle.

Order #	Length	12+	6+	1+
53-1402	4"	\$2.81	\$2.97	\$3.30





BENCH KNIFE

Heavy-duty, bench knife. Thick steel blade. Heavy hardwood handle.

Order #	Length	Blade Length	12+	6+	1+
39-0626	5½"	1½"	\$3.74	\$3.96	\$4.40



MEDIUM-DUTY BENCH KNIFE

Used for opening watchcases, scraping, and cutting. Blade is mounted in hardwood handle.

Order #	Length	Blade Length	12+	6+	1+
39-1800	5"	1¾"	\$8.41	\$8.91	\$9.90



TUNGSTEN-CARBIDE SCRAPERS

Flat-sided, tungsten-carbide scrapers are ideal for flash and bur removal on precious metals. Recommended for platinum.

Item	Order #	Length	Tip Length	Tip Diameter	12+	6+	1+
A	18-0520	6¼"	1¼"	3mm	\$17.21	\$18.23	\$20.25
B	18-0521	6¼"	1¼"	4mm	\$17.21	\$18.23	\$20.25



STEEL BURNISHERS

Highly polished blades mounted in wooden handles. Used for smoothing bezels around stones as well as other parts of soft metals.

Item	Order #	Description	Length	Tip Length	12+	6+	1+
C	18-0500	Curved Blade	5¾"	1"	\$10.84	\$11.48	\$12.75
D	18-0502	Straight Blade	5½"	1"	\$8.46	\$8.96	\$9.95
E	18-0510	Curved Blade	6"	2"	\$8.46	\$8.96	\$9.95



TUNGSTEN-CARBIDE BURNISHERS

Highly polished and very hard burnishers made of tungsten carbide. Used for closing bezels, smoothing away scratches, and burnishing metals to a brilliant shine. Recommended for platinum work.

Item	Order #	Length	Tip Length	Tip Diameter	12+	6+	1+
F	18-0516	6¾"	1"	2mm	\$14.88	\$15.75	\$17.50
G	18-0517	6¾"	1"	3mm	\$14.88	\$15.75	\$17.50
H	18-0518	6¾"	1"	4mm	\$14.88	\$15.75	\$17.50
J	18-0519	6¾"	1"	5mm	\$14.24	\$15.08	\$16.75



SLIM BURNISHERS

Slim steel burnishers with hardwood handles are perfect for smaller jobs. Highly polished steel assures the user a smooth finish every time. Hardwood handle is the right grip for this well made burnisher. Some prefer straight, others bent—the choice is yours!

Item	Order #	Description	Length	Tip Length	12+	6+	1+
K	18-0525	Straight Blade	6"	2¼"	\$5.27	\$5.58	\$6.20
L	18-0526	Bent Blade	6½"	2½"	\$6.55	\$6.93	\$7.70



TUNGSTEN-CARBIDE ROLLER BURNISHERS

High-quality, tungsten-carbide roller burnishers are ideal for removing small or coarse pinholes and scratches on platinum or gold.

Item	Order #	OD	Length	Edges	Grade	Application	12+	6+	1+
A	18-0535	5mm	13mm	12	Coarse	Gold	\$30.41	\$31.73	\$33.05
B	18-0536	5mm	13mm	18	Medium	Gold/Platinum	\$30.41	\$31.73	\$33.05
C	18-0537	5mm	13mm	36	Fine	Platinum	\$30.82	\$32.16	\$33.50
D	18-0538	10mm	7mm	18	Medium	Gold/Platinum	\$30.82	\$32.16	\$33.50
E	18-0539	10mm	7mm	36	Fine	Gold/Platinum	\$30.82	\$32.16	\$33.50



MARGIN ROLLER BURNISHERS

Individually sized burnishing tools that effectively remove porosity, pits, or scratches on the inside of rings and bracelets.

Item	Order #	Diameter	Shank	12+	6+	1+
F	18-0530	5mm	3/32"	\$15.15	\$16.43	\$18.25
G	18-0531	8mm	3/32"	\$32.20	\$33.60	\$35.00
H	18-0532	10mm	3/32"	\$34.34	\$36.36	\$40.40
J	18-0533	12mm	3/32"	\$43.93	\$45.84	\$47.75



POROSITY KILLER

Fills minor porosity holes in gold, silver, platinum, and other metals. Eliminates the need for extra filing and filling holes with solder.

Order #	Wheel Size	Shank	12+	6+	1+
18-0545	1/2" square	3/32"	\$12.11	\$12.83	\$14.25



BUSCH® TUNGSTEN-CARBIDE POLISHERS

Produce a brilliant polish on platinum and gold with the Busch® tungsten-carbide polishers. These polishers are made of the finest tungsten-carbide material, which makes them ideal for platinum polishing. The four different shapes highlight surfaces, edges, elevated areas, and recessed or relatively inaccessible spots.

Item	Order #	Description	Shank	12+	6+	1+
K	18-0540	Round End Pointer	3/32"	\$43.19	\$45.07	\$46.95
L	18-0541	Barrel Polisher	3/32"	\$43.19	\$45.07	\$46.95
M	18-0542	Cone Polisher	3/32"	\$43.19	\$45.07	\$46.95
N	18-0543	Point Polisher	3/32"	\$43.19	\$45.07	\$46.95



CHASING TOOL SET

Set of 22 punches with differently shaped ends for making decorative designs on sheet metal. The ends of the tools are struck with a chasing hammer while the work is held in a pitch bowl.



Order #	Description	Length	12+	6+	1+
25-1347	22 Punches	3 7/32" - 3 11/16"	\$106.04	\$112.28	\$124.75



Tips enlarged to show detail.



MASTER BEADING TOOL SET

Deluxe Swiss-made beading tool set consists of:

- 100 beading tools
- Five each no. 5-6-7-8
- 15 each no. 9-10-11-12
- Five each no. 13-14-15-16
- Beading plate, beading tool handle, and 40-hole deluxe wood holder

Item	Order #	Description	12+	6+	1+
A	53-1725	Swiss Beading Kit	\$136.00	\$144.00	\$160.00



BEADING TOOL SETS

Genuine Swiss beading tool sets and individual sizes. 3/32" shank. Used mostly in beading or bright-cut settings. Can also be used to make beaded edge designs. Smallest (.25mm) to largest (1.35mm)



Kit Order # 77-29000	
B. Set of 12 (1 each) .25mm-1.35mm	C. Set of 23 (1 each) .25mm-1.35mm

Order #	77-29000	12+	6+	1+
Shank Size	3/32"	\$17.43	\$21.00	\$23.76
	Sold Each		\$22.44	\$26.40

Tool #	Shank Size							
	.25mm	.30mm	.35mm	.40mm	.45mm	.50mm	.55mm	.60mm
12+	\$1.16	\$1.16	\$1.16	\$1.16	\$1.16	\$1.16	\$1.16	\$1.16
6+	\$1.32	\$1.32	\$1.32	\$1.32	\$1.32	\$1.32	\$1.32	\$1.32
1+	\$1.65	\$1.65	\$1.65	\$1.65	\$1.65	\$1.65	\$1.65	\$1.65

Tool #	Shank Size							
	.65mm	.70mm	.75mm	.80mm	.85mm	.90mm	.95mm	1.00mm
12+	\$1.16	\$1.16	\$1.16	\$1.16	\$1.16	\$1.16	\$1.16	\$1.16
6+	\$1.32	\$1.32	\$1.32	\$1.32	\$1.32	\$1.32	\$1.32	\$1.32
1+	\$1.65	\$1.65	\$1.65	\$1.65	\$1.65	\$1.65	\$1.65	\$1.65

Tool #	Shank Size							
	1.05mm	1.10mm	1.15mm	1.20mm	1.25mm	1.30mm	1.35mm	
12+	\$1.16	\$1.16	\$1.16	\$1.16	\$1.16	\$1.16	\$1.16	
6+	\$1.32	\$1.32	\$1.32	\$1.32	\$1.32	\$1.32	\$1.32	
1+	\$1.65	\$1.65	\$1.65	\$1.65	\$1.65	\$1.65	\$1.65	



Item	Order #	Description	12+	6+	1+
D	77-2940	Bending Tool Handle	\$2.56	\$2.88	\$3.20



BRACELET HOLDER

Used to hold bracelets in place when setting stones in prong, pavé, or channel settings. Saves time and eliminates the need for shellac. Holds bracelets up to 7mm wide and will not mar or distort. Space for clasp on outer side of holder. Made of aluminum. 3 1/2" diameter. Includes hex wrench.

Item	Order #	Diameter	Width	12+	6+	1+
E	43-0600	3 1/2"	1/4"	\$27.88	\$29.52	\$32.80

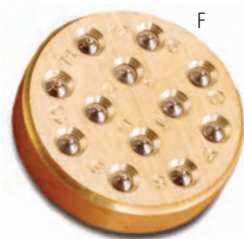

BEAD BLOCK

In order to sharpen and reshape the tips of your beading tools, apply slight pressure to the beading tool and rotate the tip within the round shape hole. Re-insert the tip and repeat the process until shape is uniform.

Item	Order #	Description	12+	6+	1+
F	53-1726	Sharpening Block	\$25.50	\$27.00	\$30.00

MILLRITE MILGRAIN MACHINE

The Milgrain is an innovative machine that allows you to create professional decorative designs on rings without the need of a lathe. The designs are cold formed in the surface of the ring without the loss of any precious metal. A variety of tools are available to provide clean, well-defined designs according to the chosen styles. The machine comes complete with 10 collets for ring sizes from #2-13, one milgrain tool, and an allen key.

Item	Order #	Description	12+	6+	1+
A	26-6000	Milgrain Machine	—	—	\$550.00
B	26-6001	Set of 10 Collets	\$12.79	\$13.55	\$15.05

STANDARD EMBOSSING WHEELS (6mm diameter, 1/8" shank)

26-6002	M4 Indented Bead Pattern	\$61.00	\$63.65	\$66.30
26-6002	F4 Raised Bead Pattern	\$61.00	\$63.65	\$66.30
26-6002	M6 Indented Bead Pattern	\$61.00	\$63.65	\$66.30
26-6002	F6 Raised Bead Pattern	\$61.00	\$63.65	\$66.30
26-6002	M8 Indented Bead Pattern	\$61.00	\$63.65	\$66.30
26-6002	F8 Raised Bead Pattern	\$61.00	\$63.65	\$66.30
26-6002	M9 Indented Bead Pattern	\$61.00	\$63.65	\$66.30
26-6002	F9 Raised Bead Pattern	\$61.00	\$63.65	\$66.30
26-6002	M10 Indented Bead Pattern	\$61.00	\$63.65	\$66.30
26-6002	F10 Raised Bead Pattern	\$61.00	\$63.65	\$66.30

MILLRITE PLUS MILGRAIN MACHINE

The Millrite Plus Millgrain Machine allows you to create designs on your rings, even on angled or perpendicular surfaces. This machine accepts both lathe millgrain tools and french millgrain tools. It also includes collets for ring sizes 2- 14. The machine is quality crafted of aluminium alloy with spring action tool holders that ensure clean, crisp, even impressions.

Item	Order #	Description	1+
C	26-6003	Milgrain Machine	\$640.00



STANDARD 1/8" SHANK

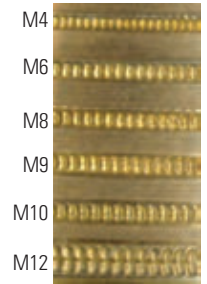
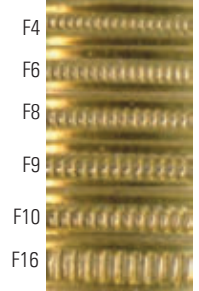

Bench Tools

Kit Order # 53-1000

Round Set (1 each) #1 - #15	Oval Set (1 each) #1 - #15
-----------------------------	----------------------------

Order #	53-00000
Length	3"
Cup-shaped Cutters	

12+	\$55.20	\$57.60
6+	\$60.00	\$55.20
1+	\$57.60	\$60.00

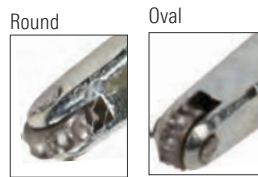

MILGRAIN TOOLS

Cup-shaped cutters used to form a decorative bead or fine row of cuts on any piece of jewelry. Set of six contains sizes 2, 4, 6, 8, 10, 12, and a chuck holding handle. Smallest (#1) to Largest (#15).

Tool #	Round #1	Round #10	Round #2	Round #3	Round #4	Round #5	Round #6	Round #7	Round #8	Round #9
12+	\$9.89	\$9.89	\$9.89	\$9.89	\$9.89	\$9.89	\$9.89	\$9.89	\$9.89	\$9.89
6+	\$10.32	\$10.32	\$10.32	\$10.32	\$10.32	\$10.32	\$10.32	\$10.32	\$10.32	\$10.32
1+	\$10.75	\$10.75	\$10.75	\$10.75	\$10.75	\$10.75	\$10.75	\$10.75	\$10.75	\$10.75

Tool #	Oval #1	Round #11	Round #12	Round #13	Round #14	Round #15	Oval #2	Oval #3	Oval #4	Oval #5
12+	\$9.89	\$9.89	\$9.89	\$9.89	\$9.89	\$9.89	\$9.89	\$9.89	\$9.89	\$9.89
6+	\$10.32	\$10.32	\$10.32	\$10.32	\$10.32	\$10.32	\$10.32	\$10.32	\$10.32	\$10.32
1+	\$10.75	\$10.75	\$10.75	\$10.75	\$10.75	\$10.75	\$10.75	\$10.75	\$10.75	\$10.75

Tool #	Oval #10	Oval #11	Oval #12	Oval #13	Oval #14	Oval #15	Oval #6	Oval #7	Oval #8	Oval #9
12+	\$9.89	\$9.89	\$9.89	\$9.89	\$9.89	\$9.89	\$9.89	\$9.89	\$9.89	\$9.89
6+	\$10.32	\$10.32	\$10.32	\$10.32	\$10.32	\$10.32	\$10.32	\$10.32	\$10.32	\$10.32
1+	\$10.75	\$10.75	\$10.75	\$10.75	\$10.75	\$10.75	\$10.75	\$10.75	\$10.75	\$10.75





JETT SETT™ KITS

Unique thermoplastic, ceramic compound used to hold delicate parts for engraving, stone setting, chasing and repairs. Jett Sett™ is non toxic, biodegradable and is an excellent substitute for orange flake shellac. It is a clay-like compound that easily dissolves in hot water and hardens to a desired shape. Reusable.

Kit A includes: - Hot Pot - Strainer - Thermometer - 1 lb Thermoplastic

Kit B includes: - Hot Pot - Strainer - Thermometer - 1 lb Plastiform

Item	Order #	Description	12+	6+	1+
A	12-2281	Thermoplastic Kit	\$80.36	\$83.86	\$87.35
B	12-2292	Plastiform Kit	\$56.30	\$58.75	\$61.20



JETT SETT™ THERMOPLASTIC COMPOUND

Jett Sett™ is a thermoplastic compound used for stone setting, riveting, engraving, and holding parts. Use it to make rigid molds, drying forms, texture plates, and custom clay stamping tools. Make custom handles and grips for your favorite tools. Jett Sett™ has ceramic component that makes it so strong it can be used to make dies for hydraulic presses. Jett Sett™ is made workable by soaking pellets in hot water, then gathering it into a ball of pliable material. Jett Sett™ becomes rock hard when it cools and cannot be chipped, cracked, or broken even when applying force with hammers or hydraulics.

Order #	Description	Container Volume	12+	6+	1+
12-2280	Thermoplastic Compound	1 lb	\$36.62	\$38.21	\$39.80



JETT SETT™ PLASTIFORM

Plastiform is a low temperature, hand-formable, non-toxic thermoplastic with many uses for the jewelry industry. It is a unique material that is resilient plastic at room temperature but melts into a clear gel at only 140°. This process can be repeated indefinitely, making Plastiform very economical to use. Plastiform was originally developed for the jewelry industry as a shellac substitute.

Order #	Description	Container Volume	12+	6+	1+
12-2288	Plastiform Compound	1 lb	\$22.04	\$24.80	\$27.55



PITCH BOWL KIT

Suitable for holding or supporting jewelry for engraving. The bowl is made of cast iron and rests on a rubber pad. The bowl can be tipped to a comfortable working angle. Includes: pitch, bowl, and rubber pad.

Order #	Description	Outside Diameter	1+
26-4205	Pitch Bowl Set	6¼"	\$39.75

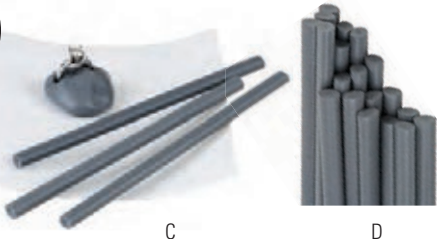

THERMO-LOC® STARTER

Kit includes 6" square PTFE (Teflon pad) and 1 lb. Thermo-Loc® sticks. Thermo-Loc® is a special reusable polymer material that is rigid at room temperature yet becomes softly pliable when heated/ warmed. Always place on Thermo-Loc® (Teflon) pad when warming in microwave oven. Ring not included.

Item	Order #	Description	12+	6+	1+
C	26-4168	Starter Kit	\$36.34	\$37.92	\$39.50
D	26-4169	1 lb of Sticks	\$29.44	\$30.72	\$32.00

ORANGE FLAKE SHELLAC

When heated, it is used to hold objects for chasing, engraving, or setting.

Order #	Description	Container Volume	12+	6+	1+
12-2270	Flake Shellac	6 oz	\$12.33	\$12.86	\$13.40

**CLAW SETTING JIG KIT**

Tool for making claw settings in sizes 0.15 to 2 carats with four, six, and eight prongs for small or large rings. The set comes with five wire holders, four retaining tubes, one main base, and instructions.

Order #	Description	12+	6+	1+
53-1425	Jig Kit	\$28.09	\$29.75	\$33.05

**SETTERS TUBE HOLDER KIT**

Holds tubes for stone setting firmly without damage. Set of seven spring-tempered three-jaw collets. Screw chuck has hardwood handle. Collets fit tube sizes 1/32" to 1/2". Shipping weight .20 lb.

Order #	Description	Length	12+	6+	1+
26-6006	Pin Vise Kit	6"	\$18.61	\$19.71	\$21.90

**FINAL TOUCH KIT**

Used for quick and secure tightening of both snap-in and hand-set round prong settings. With one light tap all four or six prongs are tightened. Urethane base and five tools are included: 2mm, 3mm-4mm, and 5mm-6mm. Base holds 12 studs.

Order #	Description	12+	6+	1+
53-1901	Secure Kit	\$60.95	\$64.53	\$71.70

**BEZEL PUNCH**

Stone setting system with hardwood handles is ideal for burnishing stones. Simply insert the stone and press the punch directly over the prongs to set. The concave shapes push prongs in gently and evenly. This system is especially good for more fragile stones.

Order #	Size Range	Assortment Qty	12+	6+	1+
53-1412	2mm-9mm	24	\$130.90	\$138.60	\$154.00

**ROUND BEZEL SETTING PUNCHES SET**

Bezel punches with concave ends for shaping bezel over round stones. Set comes with hardwood handle and wooden box.

Order #	Description	Size Range	12+	6+	1+
53-1409	Set of 18 Punches	2mm-9mm	\$133.96	\$141.84	\$157.60



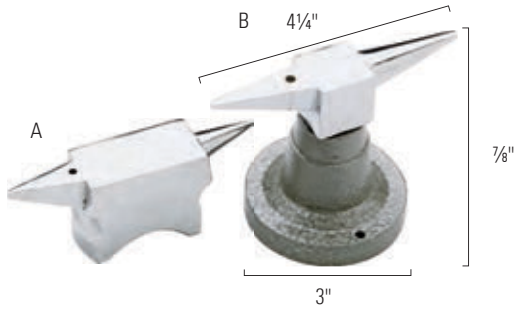

HORN ANVIL

Used for flattening and shaping. Flat and round horns are polished, and there is a hole in the top for riveting. Made of drop-forged steel, then case hardened. Used for flattening and shaping.

Item	Order #	Description	W x L x H	12+	6+	1+
A	12-3050	Horn Anvil	1 3/16" x 4 1/2" x 1 5/8"	\$22.48	\$23.81	\$26.45
B	12-3010	Double Horn Anvil	1" x 4 1/4" x 7/8"	\$15.90	\$16.83	\$18.70



LARGE HORN ANVIL

A larger version of the standard bench anvil. The larger size allows for a greater variety of tasks. Highly polished horn and top surface. It has a 5 1/8" diameter base for stability.

Order #	Description	W x H	OD	12+	6+	1+
12-3015	Large Horn Anvil	7 3/4" x 5 1/4"	5 1/8"	\$38.25	\$40.50	\$45.00



HEXAGON ANVIL

Used as a base for staking, riveting, and drilling small parts. Case-hardened and ground flat and smooth. Has 15 holes, graduated from 3/64" to 1/4", and five milled slots.

Order #	Description	W x H	12+	6+	1+
12-3117	Hexagon Anvil	1 5/8" x 3/4"	\$15.90	\$16.83	\$18.70



SLOT ANVIL

Used as a base for staking, riveting, and drilling small parts. V-Slot is handy for removing pinions and similar items. Case hardened and ground flat and smooth. Has nine graduated holes, with one size for stumps, and five milled slots.

Order #	Description	W x L x H	12+	6+	1+
12-3115	Slot Anvil	1 5/8" x 1 3/4" x 3/4"	\$12.75	\$13.50	\$15.00



FOREDOM® DRILL VISE

Plastic mini vise is great for holding gemstones and other materials that require water during the drilling process.

Order #	Description	Jaw: L x H x Capacity	12+	6+	1+
58-2434	Drill Vise	1 5/8" x 1 3/16" x 1 1/2"	\$16.83	\$17.82	\$19.80

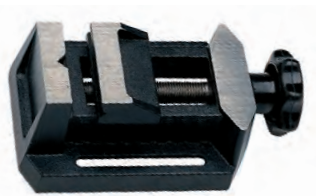

FOREDOM® MINI VISE

Zinc, die-cast, mini vise firmly grasps small work pieces for precision drilling. Has horizontal and vertical "V" grooves for holding small round pieces. Use with DP30, item 34-6302.

Order #	Description	Jaw: L x H x Capacity	12+	6+	1+
34-6301	Metal Vise	1 1/4" x 1 1/2" x 1/2"	\$21.25	\$22.50	\$25.00

STEEL BENCH BLOCK

Used to support work when flattening or laying out designs. Case-hardened. Ground flat and smooth.

Item	Order #	W x L x H	12+	6+	1+
A	12-3107	2½" x 2½" x ¾"	\$15.30	\$16.20	\$18.00
B	12-3109	4" x 4" x ¾"	\$17.85	\$18.90	\$21.00

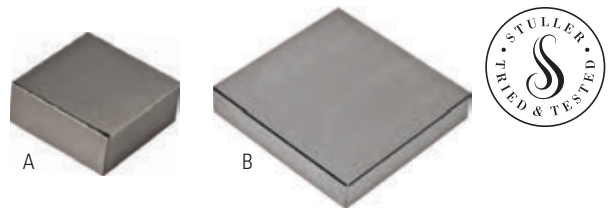

BENCH BLOCK HELPER

This three-piece well-made set allows one to hammer without excess noise and vibrations at the bench. Includes rubber ball with steel and nylon block.

Order #	Diameter	Thickness	Per Pack	12+	6+	1+
25-0572	3"	1½/16"	Box of 25	\$27.16	\$28.76	\$31.95



DURSTON BENCH BLOCKS

Durston's new high quality steel bench blocks for flattening, laying out, or chasing. Each piece is constructed out of tool steel, ground flat, polished, and case hardened.

Item	Order #	W x L x H	12+	6+	1+
C	12-3110	65mm x 65mm x 20mm	\$20.61	\$21.83	\$24.25
D	12-3110	100mm x 100mm x 20mm	\$27.20	\$28.80	\$32.00
E	12-3110	130mm x 130mm x 20mm	\$35.70	\$37.80	\$42.00

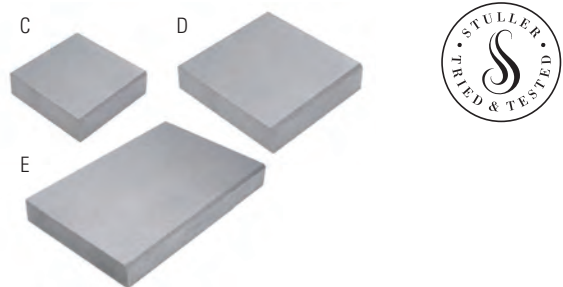

PRECISION BENCH VISE

Screw the attaching plate to the workbench to have a vise that can be set up or removed in a few seconds. Utilizes a reliable clamping device with its operating lever on the side by the vise. Absolutely smooth, parallel 45mm jaws. Fits optional mounting plate installed on bench top.

Order #	Description	1+
58-2436	Bergeon Vise with Detachable Vise	\$385.90



BENCH VISE

Sturdy construction with twin guide rods to assure parallel closing and rigidity. Smooth jaws prevent marring of soft metals. Rust-proof finish. Clamps to any bench. Jaws are 2½" wide and open to 2½". Will mount on surfaces up to 2" thick.

Order #	Description	12+	6+	1+
58-2432	Bench Vise	\$44.92	\$47.57	\$52.85



BENCH VISE

Bench vise with twin guides to assure parallel closing and rigidity. Smooth jaws prevent marring of soft metals. Jaws are 1¾" wide and open to 1¾". Will mount on surfaces up to 2" thick.

Order #	Description	12+	6+	1+
58-2430	Bench Vise	\$14.03	\$14.85	\$16.50





UNIVERSAL BALL JOINT SWIVEL VISE WITH VACU-BASE

Portable universal ball joint rotates vise to any desired working angle. Attaches instantly to any smooth surface. Large v-grooved iron jaws open to 3" with precision, screw action. Unit also comes with a set of rubber jaws.

Order #	Description	12+	6+	1+
58-1030	Swivel Vise	\$48.62	\$51.48	\$57.20



BENCH VISE PADS

Magnetic strips hold Soft Jaws™ to your bench vise. The cushioned pads grip odd or round shapes and threaded parts preventing marring of finished surfaces. They fit 3" to 4" wide bench vises, but can be mounted on larger vises. Do not use to hold glass bottles or beakers.

Order #	Description	Width	12+	6+	1+
58-2438	Vise Pads	3½"	\$7.48	\$7.92	\$8.80



MULTI-PURPOSE VISE

Precision steel vise for the BenchMate™ system uses the versatile lift-on, lift-off mounting system. This vise tilts and rotates on two axes to virtually any position. Your work moves to accommodate you rather than you adjusting to your work. Jaws are 2⅓" wide, 1⅔" tall, and open to 1⅝".

Order #	Description	12+	6+	1+
26-4144	Multi-Purpose Vise	\$138.72	\$146.88	\$163.20
26-4155	Attachment Set	\$96.35	\$102.02	\$113.35

**DOUBLE ROW MOUNTED
MINIATURE BRISTLE BRUSHES**

Great for cleaning and polishing hard to reach areas. For use with flexshaft machines.

Item	Order #	Grade	Rows	OD	Shank	12+	6+	1+
A	16-6070	Soft	2	3/4"	3/32"	\$22.00	\$24.75	\$27.50
B	16-6072	Hard	2	3/4"	3/32"	\$22.00	\$24.75	\$27.50

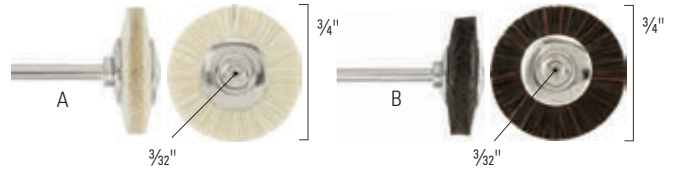

**UNMOUNTED
BRISTLE BRUSHES**

Item	Order #	Grade	OD	Shank	12+	6+	1+
C	16-6019	Stiff	1"	1/8"	\$6.35	\$6.62	\$6.90
	16-6018	Medium	1"	1/8"	\$6.35	\$6.62	\$6.90
	16-6017	Soft	1"	1/8"	\$6.35	\$6.62	\$6.90
D	16-6016	Extra Soft	1"	1/8"	\$6.35	\$6.62	\$6.90
	16-6014	Stiff	3/4"	1/8"	\$4.46	\$4.66	\$4.85
	16-6013	Medium	3/4"	1/8"	\$4.46	\$4.66	\$4.85
E	16-6012	Soft	3/4"	1/8"	\$4.65	\$4.85	\$5.05
	16-6011	Extra Soft	3/4"	1/8"	\$4.65	\$4.85	\$5.05
	16-6029	Stiff	1"	3/32"	\$5.61	\$5.86	\$6.10
F	16-6028	Medium	1"	3/32"	\$5.70	\$5.95	\$6.20
	16-6027	Soft	1"	3/32"	\$6.35	\$6.62	\$6.90
	16-6026	Extra Soft	1"	3/32"	\$6.35	\$6.62	\$6.90
G	16-6024	Stiff	3/4"	3/32"	\$4.46	\$4.66	\$4.85
	16-6023	Medium	3/4"	3/32"	\$4.46	\$4.66	\$4.85
	16-6022	Soft	3/4"	3/32"	\$4.65	\$4.85	\$5.05
	16-6021	Extra Soft	3/4"	3/32"	\$4.65	\$4.85	\$5.05

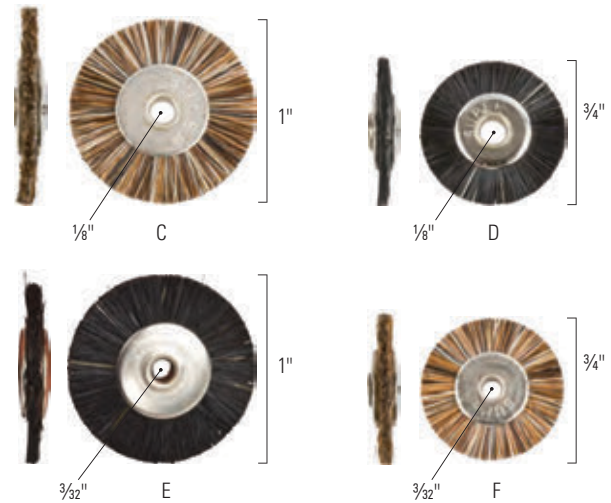

SUGGESTED MANDRELS

Nickel-plated small wheel mandrels.

G	43-1280	Reinforced Screw Mandrel	3/32"	\$0.89	\$0.95	\$1.05
H	43-1282	Heavy Duty Mandrel	3/32"	\$1.47	\$1.68	\$2.10



**MOUNTED
BRISTLE BRUSHES**

Item	Order #	Grade	OD	Shank	12+	6+	1+
J	16-6059	Stiff	1"	3/32"	\$3.91	\$4.08	\$4.25
	16-6058	Medium	1"	3/32"	\$3.91	\$4.08	\$4.25
	16-6057	Soft	1"	3/32"	\$3.91	\$4.08	\$4.25
	16-6056	Extra Soft	1"	3/32"	\$3.91	\$4.08	\$4.25
K	16-6055	Stiff	3/4"	3/32"	\$3.91	\$4.08	\$4.25
	16-6054	Medium	3/4"	3/32"	\$3.91	\$4.08	\$4.25
	16-6053	Soft	3/4"	3/32"	\$3.91	\$4.08	\$4.25
	16-6052	Extra Soft	3/4"	3/32"	\$3.91	\$4.08	\$4.25
L	16-6071	Soft	3/4"	1/8"	\$13.94	\$14.54	\$15.15

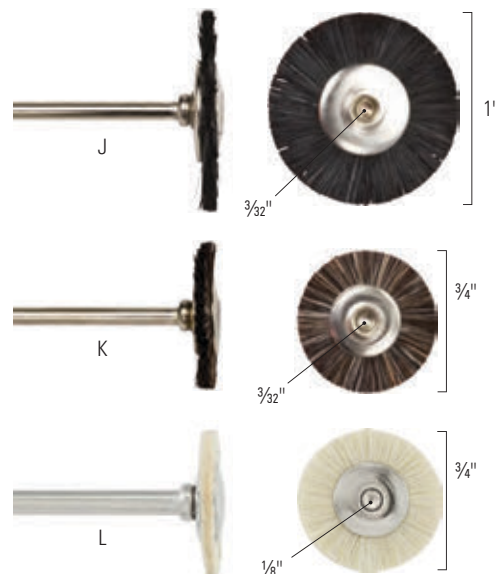

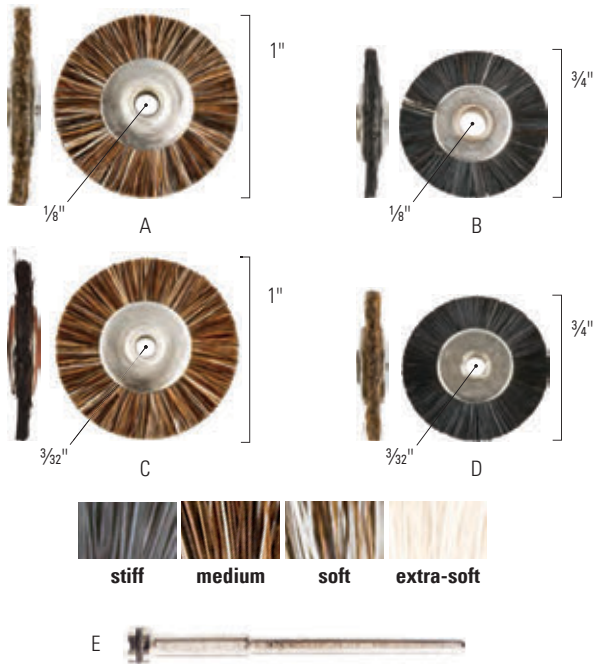

**UNMOUNTED
BRISTLE BRUSHES**

Item	Order #	Grade	OD	Shank	12+	6+	1+
A	16-5997	Stiff	1"	1/8"	\$2.02	\$2.11	\$2.20
	16-5998	Medium	1"	1/8"	\$2.02	\$2.11	\$2.20
	16-5999	Soft	1"	1/8"	\$2.02	\$2.11	\$2.20
B	16-6000	Extra Soft	1"	1/8"	\$2.02	\$2.11	\$2.20
	16-5993	Stiff	3/4"	1/8"	\$2.02	\$2.11	\$2.20
	16-5994	Medium	3/4"	1/8"	\$2.02	\$2.11	\$2.20
C	16-5995	Soft	3/4"	1/8"	\$2.02	\$2.11	\$2.20
	16-5996	Extra Soft	3/4"	1/8"	\$2.02	\$2.11	\$2.20
	16-5985	Stiff	1"	3/32"	\$2.02	\$2.11	\$2.20
D	16-5986	Medium	1"	3/32"	\$2.02	\$2.11	\$2.20
	16-5987	Soft	1"	3/32"	\$2.02	\$2.11	\$2.20
	16-5988	Extra Soft	1"	3/32"	\$2.02	\$2.11	\$2.20
E	16-5992	Stiff	3/4"	3/32"	\$2.02	\$2.11	\$2.20
	16-5991	Medium	3/4"	3/32"	\$2.02	\$2.11	\$2.20
	16-5990	Soft	3/4"	3/32"	\$2.02	\$2.11	\$2.20
	16-5989	Extra Soft	3/4"	3/32"	\$2.02	\$2.11	\$2.20

SUGGESTED MANDRELS
Nickel-plated small wheel mandrels.

E	43-1280	Reinforced Screw Mandrel	3/32"	\$0.89	\$0.95	\$1.05
---	---------	--------------------------	-------	--------	--------	--------

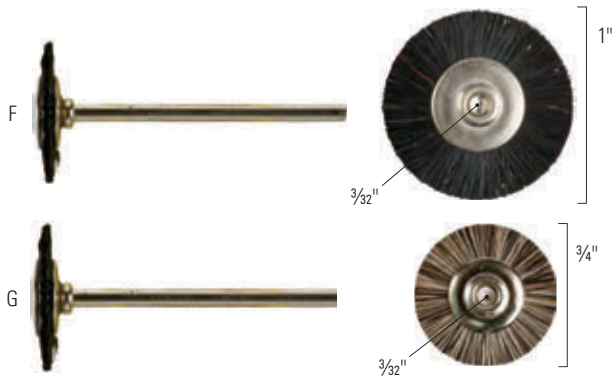

**MOUNTED
BRISTLE BRUSHES**

Item	Order #	Brush Type	OD	Shank	12+	6+	1+
F	16-6009	Stiff	1"	3/32"	\$2.02	\$2.11	\$2.20
	16-6007	Soft	1"	3/32"	\$2.02	\$2.11	\$2.20
	16-6006	Extra Soft	1"	3/32"	\$2.02	\$2.11	\$2.20
G	16-6004	Stiff	3/4"	3/32"	\$2.02	\$2.11	\$2.20
	16-6003	Medium	3/4"	3/32"	\$2.02	\$2.11	\$2.20
	16-6002	Soft	3/4"	3/32"	\$2.02	\$2.11	\$2.20
	16-6010	Medium	3/4"	3/32"	\$7.64	\$8.60	\$9.55



STULLER SELECT BRISTLE BRUSHES

	Order #	Grade	Length	OD	Shank	12+	6+	1+
END	16-7008	Stiff	3/16"	3/8"	3/32"	\$6.60	\$7.16	\$7.95
	16-7007	Soft	3/16"	3/8"	3/32"	\$6.60	\$7.16	\$7.95
	16-7001	Stiff	3/16"	1/4"	3/32"	\$6.60	\$7.16	\$7.95
	16-7000	Soft	3/16"	1/4"	3/32"	\$6.60	\$7.16	\$7.95
CUP	16-7535	Stiff	1/2"	9/16"	3/32"	\$3.68	\$3.84	\$4.00
	16-7530	Soft	1/2"	9/16"	3/32"	\$3.68	\$3.84	\$4.00
	16-7540	Stiff	1/2"	9/16"	3/32"	\$3.68	\$3.84	\$4.00

STULLER VALUE BRISTLE BRUSHES

	Order #	Grade	Length	OD	12+	6+	1+
END	16-7003	Stiff	3/16"	3/16"	\$1.91	\$2.03	\$2.25
	16-7002	Soft	3/16"	3/16"	\$1.91	\$2.03	\$2.25
	16-7009	Soft	3/8"	3/16"	\$1.91	\$2.03	\$2.25
	16-7010	Stiff	3/8"	3/16"	\$1.91	\$2.03	\$2.25

**UNMOUNTED
STULLER BRASS/STEEL WIRE BRUSHES**

	Order #	Wire Type	OD	Shank	12+	6+	1+
BRASS	16-5977	Crimped	1"	3/32"	\$8.19	\$8.54	\$8.90
	16-5978	Straight	1"	3/32"	\$8.19	\$8.54	\$8.90
	16-5981	Crimped	3/4"	3/32"	\$7.13	\$7.44	\$7.75
	16-5982	Straight	3/4"	3/32"	\$7.13	\$7.44	\$7.75
STEEL	16-5979	Crimped	1"	3/32"	\$8.19	\$8.54	\$8.90
	16-5980	Straight	1"	3/32"	\$8.19	\$8.54	\$8.90
	16-5983	Crimped	3/4"	3/32"	\$7.13	\$7.44	\$7.75
	16-5984	Straight	3/4"	3/32"	\$7.13	\$7.44	\$7.75

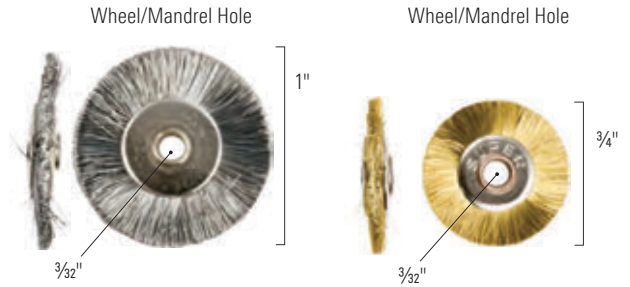

**MOUNTED
BRASS/STEEL WIRE BRUSHES**

	Order #	Wire Type	OD	Shank	12+	6+	1+
BRASS	16-5969	Crimped	1"	3/32"	\$8.28	\$8.64	\$9.00
	16-5970	Straight	1"	3/32"	\$8.28	\$8.64	\$9.00
	16-5973	Crimped	3/4"	3/32"	\$7.54	\$7.87	\$8.20
	16-5974	Straight	3/4"	3/32"	\$7.54	\$7.87	\$8.20
STEEL	16-5971	Crimped	1"	3/32"	\$8.28	\$8.64	\$9.00
	16-5972	Straight	1"	3/32"	\$8.28	\$8.64	\$9.00
	16-5975	Crimped	3/4"	3/32"	\$7.54	\$7.87	\$8.20
	16-5976	Straight	3/4"	3/32"	\$7.54	\$7.87	\$8.20

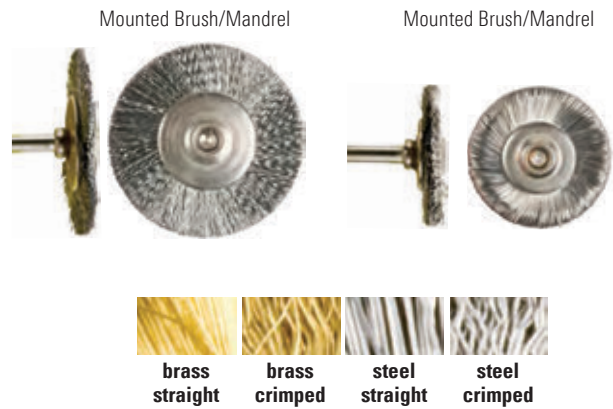

**STULLER END WIRE
MOUNTED BRUSHES**

	Order #	Wire Type	Length	OD	Shank	12+	6+	1+
BRASS	16-5965	Crimped	1/4"	3/16"	3/32"	\$5.70	\$5.95	\$6.20
	16-5966	Straight	1/4"	3/16"	3/32"	\$5.70	\$5.95	\$6.20
STEEL	16-5967	Crimped	1/4"	3/16"	3/32"	\$5.70	\$5.95	\$6.20
	16-5968	Straight	1/4"	3/16"	3/32"	\$5.70	\$5.95	\$6.20



BRASS/STEEL WIRE BRUSHES

Clean and surface-finish brass and other metals. Straight wire produces a coarser finish.

	Order #	Wire Type	Rows	OD	12+	6+	1+
BRASS	16-4464	Crimped	4	4"	\$11.27	\$11.76	\$12.25
	16-4402	Crimped	2	3"	\$6.85	\$7.15	\$7.45
STEEL	16-4624	Lightly Crimped	4	4"	\$13.48	\$14.06	\$14.65
	16-4562	Lightly Crimped	2	3"	\$8.56	\$8.93	\$9.30

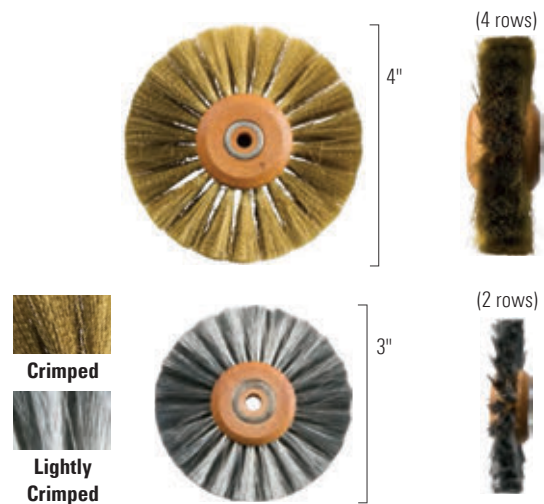

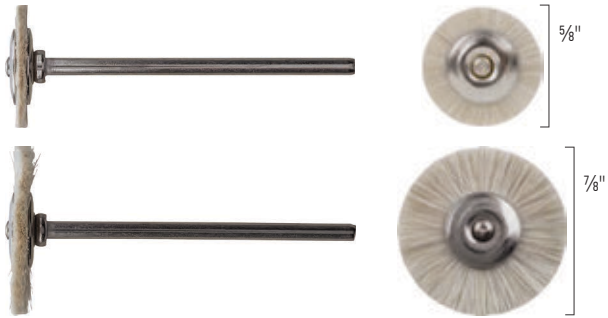

MOUNTED MINIATURE BRUSH

Order #	Grade	OD	Shank	Material	12+	6+	1+
16-7050	Soft	5/8"	3/32"	White Goat Hair	\$10.58	\$11.04	\$11.50
16-7050	Soft	7/8"	3/32"	White Goat Hair	\$10.58	\$11.04	\$11.50

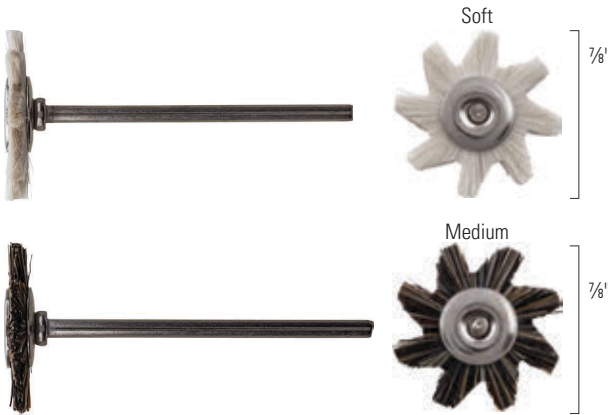

MOUNTED MINIATURE BRUSH

Geza brush mounted with this toothed shaped brush is made of high quality chung king and goat hair bristles make this the perfect brush for deep, interproximal and occlusal polishing.

Order #	Grade	OD	Shank	Material	12+	6+	1+
16-7051	Soft	7/8"	3/32"	White Goat Hair	\$11.68	\$12.19	\$12.70
16-7051	Medium	7/8"	3/32"	Grey Goat Hair	\$11.68	\$12.19	\$12.70

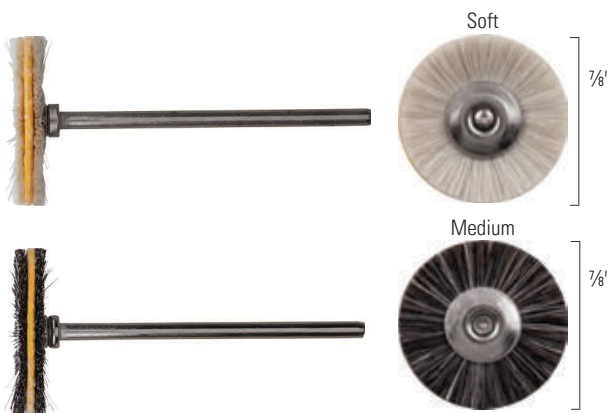

MOUNTED MINIATURE BRUSH

These bristle brushes hold compound longer and keep their shape longer. They are made in Germany and layered with a chamois insert.

Order #	Grade	OD	Shank	Material	12+	6+	1+
16-7052	Soft	7/8"	3/32"	White Goat Hair	\$18.26	\$19.06	\$19.85
16-7052	Medium	7/8"	3/32"	Grey Goat Hair	\$18.26	\$19.06	\$19.85

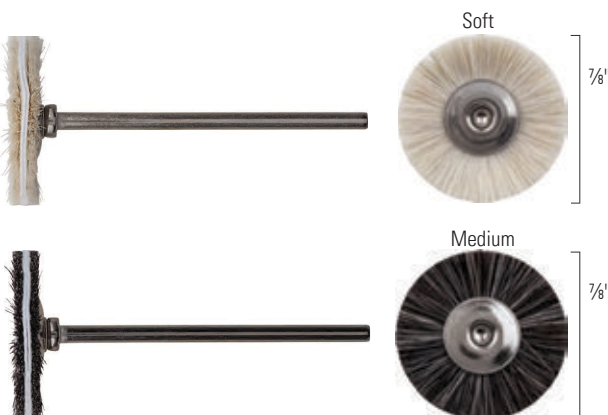

MOUNTED MINIATURE BRUSH

This mounted miniature brush is made with white goats hair with zeta cloth insert is a fine cotton tread. They hold polish very well and brushes tend to keep their shape longer.

Order #	Grade	OD	Shank	Material	12+	6+	1+
16-7053	Soft	7/8"	3/32"	White Goat Hair	\$17.80	\$18.58	\$19.35
16-7053	Medium	7/8"	3/32"	Grey Goat Hair	\$17.80	\$18.58	\$19.35



MOUNTED MINIATURE BRUSH

Astro brushes are special miniature brushes in a star design their shape is to optimally polish narrow and fine surfaces effectively, such as filigree. Made in Germany with white goat hair. Astro brushes are for fine luster.

Order #	Grade	OD	Shank	Material	12+	6+	1+
16-7054	Soft	3/4"	3/32"	White Goat Hair	\$11.22	\$11.71	\$12.20
16-7054	Soft	7/8"	3/32"	White Goat Hair	\$11.22	\$11.71	\$12.20
16-7054	Medium	3/4"	3/32"	Grey Goat Hair	\$11.22	\$11.71	\$12.20
16-7054	Medium	7/8"	3/32"	Grey Goat Hair	\$11.22	\$11.71	\$12.20

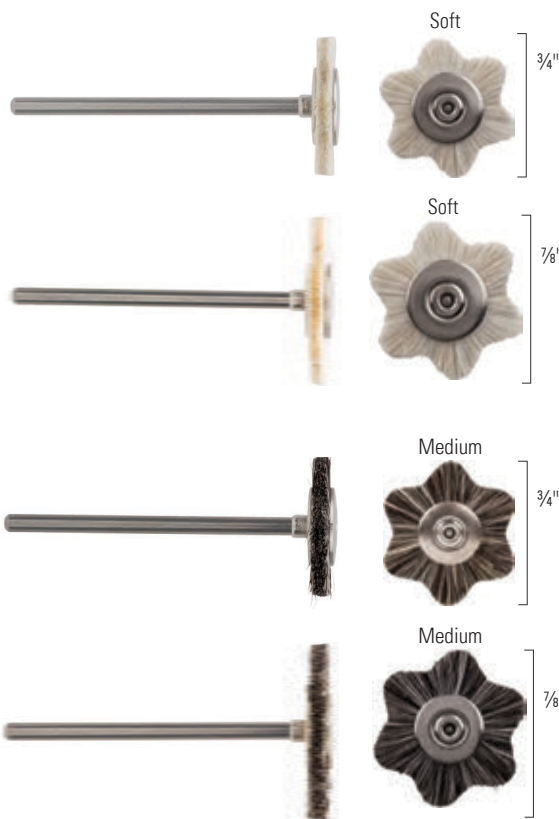

MOUNTED MINIATURE BRUSH

These mounted miniature brushes are extra soft when used with low speeds around 5000 RPM and light pressure to prep delicate surfaces.

Order #	Grade	OD	Shank	Material	12+	6+	1+
16-7055	Extra Soft	1"	3/32"	Scotch Brite	\$12.74	\$13.30	\$13.85
16-7055	Extra Soft	1"	3/32"	Resin Bonded	\$13.75	\$14.35	\$14.95



MOUNTED END BRUSH

Made of white goat hair are excellent for finishing delicate or patterned metal.

Order #	Grade	OD (mm)	Shank	Material	12+	6+	1+
16-7056	Soft	4	3/32"	White Goat Hair	\$7.96	\$8.30	\$8.65
16-7056	Extra Soft	6 1/2	3/32"	White Goat Hair	\$11.59	\$12.10	\$12.60
16-7056	Stiff	4	3/32"	Nylon Filament	\$6.53	\$6.82	\$7.10



Brushes

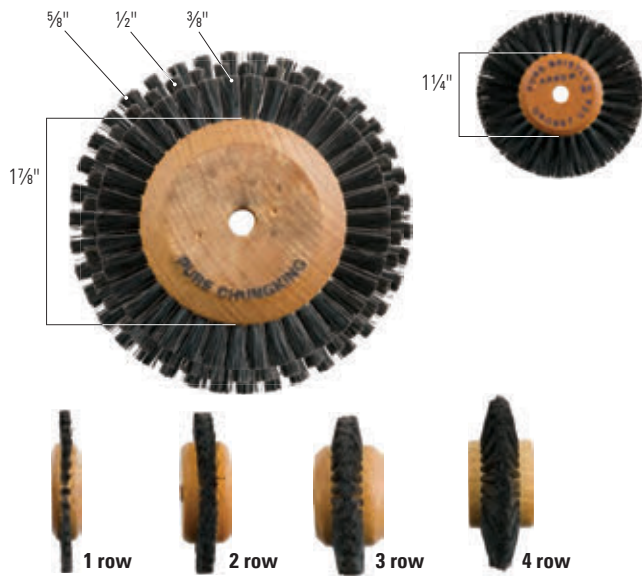

WOOD HUB BRUSHES

Premium-quality ChungKing™ bristles. Hubs are made of seasoned hardwood and are precision bored for a perfect, tapered-spindle fit.

Order #	Hub Brush Style	Hub OD	Brush Rows	Bristle Length	12+	6+	1+
16-3980	1A	1 7/8"	1	5/8"	\$0.98	\$1.03	\$1.15
16-3981	1B	1 7/8"	1	1/2"	\$0.98	\$1.03	\$1.15
16-3982	1C	1 7/8"	1	3/8"	\$0.98	\$1.03	\$1.15
16-3983	2A	1 7/8"	2	5/8"	\$1.19	\$1.26	\$1.40
16-3984	2B	1 7/8"	2	1/2"	\$1.19	\$1.26	\$1.40
16-3985	2C	1 7/8"	2	3/8"	\$1.19	\$1.26	\$1.40
16-3986	6A	1 1/4"	2	5/8"	\$1.27	\$1.35	\$1.50
16-3987	6B	1 1/4"	2	1/2"	\$1.27	\$1.35	\$1.50
16-3988	6C	1 1/4"	2	3/8"	\$1.27	\$1.35	\$1.50
16-3989	7A	1 1/4"	3	5/8"	\$2.93	\$3.11	\$3.45
16-3990	7C	1 1/4"	3	3/8"	\$2.08	\$2.25	\$2.50
16-3991	8A	1 1/4"	4	5/8"	\$2.78	\$3.02	\$3.35
16-3992	8C	1 1/4"	4	3/8"	\$2.85	\$3.02	\$3.35

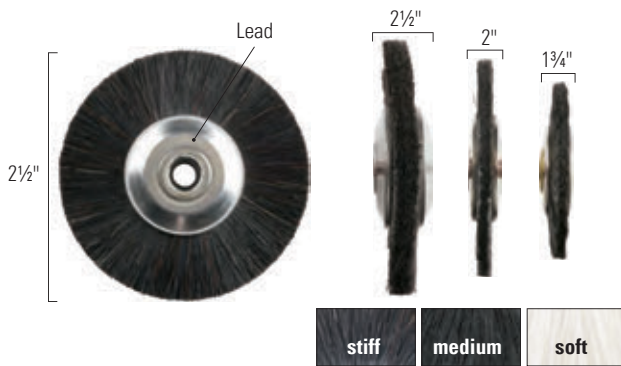

METAL HUB BRUSHES

Metal hub brushes with nylon or lead centers.

Order #	Grade	Center	OD	ID	12+	6+	1+
16-4005	Stiff	Nylon	2"	1/8"	\$2.25	\$2.38	\$2.65
16-4006	Stiff	Lead	2"	1/8"	\$2.98	\$3.15	\$3.50
16-4001	Medium	Lead	2 1/2"	1/4"	\$15.13	\$15.79	\$16.45
16-4007	Soft	Nylon	2"	1/8"	\$2.34	\$2.48	\$2.75
16-4008	Soft	Lead	2"	1/8"	\$2.55	\$2.70	\$3.00

Shown attached. (Motors not included).



TAPERED CHUCK FOR BRUSHES

For use with tapered spindle on polishing motors. Fits brushes with 1/8" holes. Can be threaded onto the hardened, steel taper, which in turn can be threaded onto a standard tapered spindle.

Item	Order #	Description	OD	12+	6+	1+
A	47-2580	Right-Handed	1/8"	\$3.13	\$3.26	\$3.40
B	47-2590	Left-Handed	1/8"	\$3.13	\$3.26	\$3.40

WOODEN HUB MANDREL

1/8" diameter screw mounted on wooden handle. Heavy duty for right side. For use with tapered spindle.

Item	Order #	Description	OD	12+	6+	1+
C	47-2600	Wood Hub Mandrel	1/8"	\$2.02	\$2.11	\$2.20

PLASTIC HUB MANDREL

Plastic hub mandrels designed to fit brushes with 1/8" arbor hole.

Item	Order #	Description	OD	12+	6+	1+
D	47-2608	Right-Handed	1/8"	\$6.50	\$6.89	\$7.65
E	47-2610	Left-Handed	1/8"	\$6.50	\$6.89	\$7.65

WHEEL MANDRELS

Hold rubber bonded abrasive wheels, grinding stones, sanding drums, brushes, and other accessories with 1/4" center mounting. Holds up to 3/4" thick.

Item	Order #	Description	Shank	12+	6+	1+
A	34-2013	Left Wheel Mandrel	5/16"	\$15.26	\$16.16	\$17.95
B	34-2014	Right Wheel Mandrel	5/16"	\$15.26	\$16.16	\$17.95

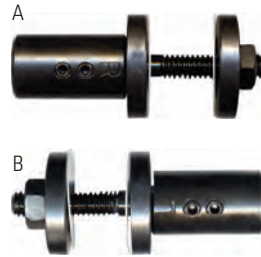

Mandrel shown attached.
(Motor not included).

WHEEL MANDREL

For right-hand side of motor. Designed to hold wheels with 1/2" arbor hole. This arbor is excellent for use with clean and finish buffs. Wheel arbor fits shaft 1/2" diameter straight motor shaft.

C. Used with unitized wheels, this plastic mandrel self-tops into the wheel.

D. Designed to hold grinding wheel on the right side of the motor with 1/2" straight shaft. For wheels with 1/2" hole.

Item	Order #	Description	OD	ID	Length	Shank	12+	6+	1+
C	10-8188	Plastic	3/4"	1/4"	2"	1/4"	\$6.16	\$6.53	\$7.25
D	47-2560	Right Arbor	1 3/4"	1/2"	3 1/2"	3/4"	\$16.51	\$17.23	\$17.95



Mandrels shown attached.
(Motors not included).

**WOODEN FLUX BRUSH**

Order #	Description	Length	12+	6+	1+
16-2597	#4 Flux Brush	4"	\$2.07	\$2.16	\$2.25

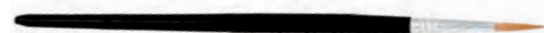
**EXTRA STIFF FLUX BRUSHES**

Excellent for use with flux and acid applications.

Item	Order #	Grade	OD	Length	12+	6+	1+
E	16-2256	Extra Stiff	1/4"	3 1/4"	\$2.35	\$2.45	\$2.55
F	16-2255	Stiff	3/8"	5 3/4"	\$1.75	\$1.82	\$1.90
G	16-2257	Extra Stiff	1/2"	5 3/4"	\$2.99	\$3.12	\$3.25

**FLUX BRUSH WITH TIN FERRULE**

Ideal for applying fluxes and other liquids. Inexpensive and disposable.

Order #	Description	12+	6+	1+
16-2250	Flux Brush	\$5.20	\$5.42	\$5.65





RED SABLE BRUSHES

Select, pure-red sable tips, hand cupped with needle-sharp points. Bristles are mounted in aluminum, seamless ferrules, which are mounted on wooden handles.

Order # 16-2701

Brush Length 7¼"
#2/0 (smallest), #7 (largest)
Sold Each

Brush Size	#2/0	#1	#2	#3	#4	#5	#6	#7
12+	\$0.78	\$0.97	\$0.97	\$1.15	\$1.47	\$1.75	\$2.02	\$2.35
6+	\$0.82	\$1.01	\$1.01	\$1.20	\$1.54	\$1.82	\$2.11	\$2.45
1+	\$0.85	\$1.05	\$1.05	\$1.25	\$1.60	\$1.90	\$2.20	\$2.55



SCRATCH BRUSHES

Scratch brushes have pen-shaped handles and come in four different styles. Used for removing rust or corrosion in hard-to-reach places. Clogged burs are best cleaned using the brass model. Fine, fiberglass bristles are mounted in a plastic, transparent case. Bristle length can be adjusted as they wear down by twisting the cap. Includes one brush.

Item	Order #	Description	Brush Length	Bristle Length	12+	6+	1+
A	16-0560	Steel Scratch Brush	4½"	1½"	\$8.33	\$8.69	\$9.05
B	16-0570	Nylon Scratch Brush	4½"	1½"	\$8.33	\$8.69	\$9.05
C	16-0580	Fiberglass Scratch Brush	4½"	1½"	\$6.44	\$6.72	\$7.00
D	16-0590	Brass Scratch Brush	4½"	1½"	\$8.00	\$8.35	\$8.70
E	16-0565	Steel Refill (Pack of 6)		1½"	\$6.30	\$6.58	\$6.85
F	16-0575	Nylon Refill (Pack of 6)		1½"	\$5.29	\$5.52	\$5.75
G	16-0585	Fiberglass Refill (Pack of 6)		1½"	\$4.65	\$4.85	\$5.05
H	16-0595	Brass Refill (Pack of 6)		1½"	\$5.84	\$6.10	\$6.35



CLEANING UTILITY BRUSH

Ideal for cleaning small parts while at the bench.

Item	Order #	Description	Length	Bristle Length	12+	6+	1+
J	16-0551	Nylon	7"	½"	\$2.35	\$2.45	\$2.55
	16-0551	Brass	7"	½"	\$2.35	\$2.45	\$2.55
	16-0551	Steel	7"	½"	\$2.35	\$2.45	\$2.55
K	16-0552	Nylon Double Ended	7"	1¼"	\$2.35	\$2.45	\$2.55



BRASS BRUSH

Bristles are finer than most and the handle is curved for better access.

Item	Order #	Grade	W x L	Brush	12+	6+	1+
A	16-3111	Fine Bristles	3/8" x 7 3/4"	1 1/2"	\$8.24	\$8.73	\$9.70

STAINLESS STEEL BRUSH

Bristles are finer than most and the handle is curved for better access.

Item	Order #	Grade	W x L	Brush	12+	6+	1+
B	16-3112	Fine Bristles	3/8" x 7 3/4"	1 1/2"	\$8.24	\$8.73	\$9.70

BRASS SCRATCH BRUSH WITH WOODEN HANDLE

Bristles firmly anchored in handles. Suitable for cleaning in and with solutions. Contains four rows of .003" wire.

Item	Order #	Grade	W x L	Brush	12+	6+	1+
C	16-3100	Medium Bristles	3/4" x 8 1/4"	3 1/4"	\$10.30	\$10.75	\$11.20

GLASGOW WASHOUT BRUSHES

Contains four rows of white bristles that are locked in a wooden handle. Used for cleaning PC boards and other washing applications. Made in Germany.

Item	Order #	Grade	Tool Length	Brush	12+	6+	1+
D	16-0598	Hard Bristles	10 3/4"	5 3/4"	\$6.35	\$6.62	\$6.90
E	16-0599	Medium Bristles	10 3/4"	5 3/4"	\$6.35	\$6.62	\$6.90

WOOD HANDLE WASHOUT BRUSH

Excellent for cleaning operations. Brushes are impervious to most cleaning fluids and hot water. Contains four rows of stiff natural bristles.

Item	Order #	Grade	W x L	Brush	12+	6+	1+
F	16-0530	Stiff Bristles	3/4" x 8 1/4"	3 1/2"	\$4.37	\$4.56	\$4.75

PLASTIC HANDLE WASHOUT BRUSH

Contains four rows of stiff, nylon bristles.

Item	Order #	Grade	W x L	Brush	12+	6+	1+
G	16-0540	Stiff Bristles	1/2" x 7 1/2"	3"	\$7.31	\$7.63	\$7.95

BENCH DUSTER

Makes cleaning your bench area quick and easy. This brush contains four rows of soft, black bristles mounted in a wooden handle. Ideal for sweeping filings and general purpose cleanup.

Item	Order #	Grade	W x L	Brush	12+	6+	1+
H	16-0510	Soft Bristles	2 1/8" x 9 1/2"	4"	\$7.04	\$7.34	\$7.65

MULTI-PURPOSE CLEANING BRUSH

Contains four rows of nylon bristles mounted in an angled, Lucite™ handle.

Item	Order #	Grade	Tool Length	Brush	12+	6+	1+
J	16-0550	Medium Bristles	6 3/4"	1 3/4"	\$2.67	\$2.78	\$2.90

HAND AND FINGERNAIL SCRUB BRUSH

Designed to help clean hands and fingernails easily after working with jewelry and rouges. Bristles are nylon.

Item	Order #	Grade	W x L	12+	6+	1+
K	16-0520	Extra Soft	1 1/2" x 3 1/2"	\$5.20	\$5.42	\$5.65



Brushes



PANTHER SETTING BUR KIT

This 20 piece ball bur kit consist of a nice wooden box with 20 burs made of the finest quality tool steel. These are very durable burs with an exceptional history of durability and performance.
1 each: .90mm-5.00mm plus wooden box.

Order #	Set of	Description	12+	6+	1+
19-3152	20	1 each: .90mm-5.00mm	\$74.82	\$81.14	\$90.15



PANTHER BALL BUR KIT

This 18 piece kit consist of 18 setting burs neatly displayed in a wooden box. Made of the finest quality tool steel, these burs display exceptional durability and performance.
1 each: .90mm to 4.50mm with wooden box.

Order #	Set of	Description	12+	6+	1+
19-3160	18	1 each: .90mm-4.50mm	\$43.99	\$47.70	\$53.00



PANTHER MASTER BUR KIT

This master bur 82 piece kit is German made of the finest quality hardened tool steel. This consist of a nice wooden box displayed with; 90, 70, round, bud, setting, cylinder, and square cone burs.

Order #	Set of	Description	12+	6+	1+
19-3860	82	Master Bur Kit	\$167.25	\$181.35	\$201.50



A

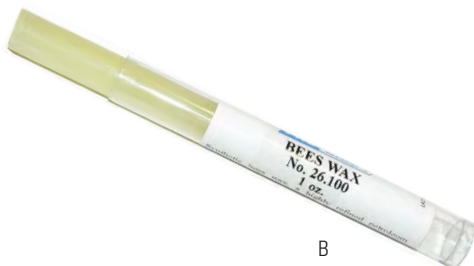

B

STULLER SELECT LUBE

Petroleum-based lubricant that extends the useful life of burs, saw blades, and cutting tools.

Item	Order #	Description	12+	6+	1+
A	21-0740	Push-up Lubricant	\$4.59	\$4.86	\$5.40
B	26-1000	Beeswax	\$3.50	\$3.65	\$3.80



The Mark of Excellence

Made in Germany. Panther® has earned a reputation for the highest standards in precision tool production in the world. Our burs and tools are manufactured on the most technically advanced computer assisted machinery in existence. Only the finest quality hardened tool steel is used. Each tool is individually hand inspected before leaving the factory. Our highly trained technicians take pride in producing the most exceptional, durable precision burs available anywhere. Once you experience the performance of a Panther® bur, you will never accept a substitute.

Order # 77-10000

Material Tungsten Vanadium Steel
 Head Shape Bud
 Shank Size 3/32"
 Sold in packs of 6

Kit Order # 77-1560
Set of 12 Burs (1 each) .90mm–3.1mm

12+	6+	1+
\$10.54	\$11.16	\$12.40

	0.6mm	0.7mm	0.8mm	0.9mm	1.0mm	1.2mm	1.4mm	1.5mm	1.6mm	1.8mm
12+	\$4.32	\$4.32	\$4.32	\$4.32	\$4.32	\$4.32	\$4.32	\$4.32	\$4.32	\$4.32
6+	\$4.68	\$4.68	\$4.68	\$4.68	\$4.68	\$4.68	\$4.68	\$4.68	\$4.68	\$4.68
1+	\$5.20	\$5.20	\$5.20	\$5.20	\$5.20	\$5.20	\$5.20	\$5.20	\$5.20	\$5.20

	2.1mm	2.3mm	2.5mm	2.7mm	2.9mm	3.1mm	3.3mm	3.5mm	3.7mm	4.0mm
12+	\$4.32	\$4.32	\$9.30	\$9.30	\$9.30	\$9.30	\$9.30	\$9.30	\$9.30	\$17.13
6+	\$4.68	\$4.68	\$10.08	\$10.08	\$10.08	\$10.08	\$10.08	\$10.08	\$10.08	\$18.14
1+	\$5.20	\$5.20	\$11.20	\$11.20	\$11.20	\$11.20	\$11.20	\$11.20	\$11.20	\$20.15

	4.2mm	4.5mm	4.7mm	5.0mm
12+	\$17.13	\$17.13	\$17.13	\$17.13
6+	\$18.14	\$18.14	\$18.14	\$18.14
1+	\$20.15	\$20.15	\$20.15	\$20.15



BUD BURS, FIG. #6

Order # 77-10001

Material Tungsten Vanadium Steel
 Head Shape Cone
 Shank Size 3/32"
 Sold in packs of 6

Kit Order # 77-1640
Set of 12 Burs (1 each) .90mm–3.1mm

12+	6+	1+
\$11.52	\$12.20	\$13.55

	0.8mm	0.9mm	1.0mm	1.2mm	1.4mm	1.6mm	1.8mm	2.0mm	2.1mm	2.2mm
12+	\$4.32	\$4.32	\$4.32	\$4.32	\$4.32	\$4.32	\$4.32	\$4.32	\$4.32	\$4.32
6+	\$4.68	\$4.68	\$4.68	\$4.68	\$4.68	\$4.68	\$4.68	\$4.68	\$4.68	\$4.68
1+	\$5.20	\$5.20	\$5.20	\$5.20	\$5.20	\$5.20	\$5.20	\$5.20	\$5.20	\$5.20

	2.3mm	2.5mm	2.7mm	2.9mm	3.0mm	3.1mm
12+	\$4.32	\$8.13	\$8.13	\$8.13	\$8.13	\$8.13
6+	\$4.68	\$8.82	\$8.82	\$8.82	\$8.82	\$8.82
1+	\$5.20	\$9.80	\$9.80	\$9.80	\$9.80	\$9.80



CONE BURS, FIG. #5



ROUND BURS, FIG. #1

Order # 77-10003
 Material Tungsten Vanadium Steel
 Head Shape Ball
 Shank Size 3/32"
 Sold in packs of 6

	Kit Order #		
	77-1097	77-1098	77-1099
	Set of 12	Set of 12	Set of 24
	(1 each)	(1 each)	(1 each)
	.50mm–2.5mm	3.1mm–8.0mm	.40mm–3.1mm
12+	\$7.57	\$8.01	\$8.90
6+	\$41.01	\$43.43	\$48.25
1+	\$14.03	\$14.85	\$16.50

	0.3mm	0.4mm	0.5mm	0.6mm	0.7mm	0.8mm	0.9mm	1.0mm	1.1mm	1.2mm
12+	\$3.27	\$3.27	\$2.95	\$2.95	\$2.95	\$2.95	\$2.95	\$2.95	\$2.95	\$2.95
6+	\$3.41	\$3.41	\$3.20	\$3.20	\$3.20	\$3.20	\$3.20	\$3.20	\$3.20	\$3.20
1+	\$3.55	\$3.55	\$3.55	\$3.55	\$3.55	\$3.55	\$3.55	\$3.55	\$3.55	\$3.55

	1.3mm	1.4mm	1.5mm	1.6mm	1.7mm	1.8mm	1.9mm	2.0mm	2.1mm	2.2mm
12+	\$2.95	\$2.95	\$2.95	\$2.95	\$2.95	\$2.95	\$2.95	\$2.95	\$2.95	\$2.95
6+	\$3.20	\$3.20	\$3.20	\$3.20	\$3.20	\$3.20	\$3.20	\$3.20	\$3.20	\$3.20
1+	\$3.55	\$3.55	\$3.55	\$3.55	\$3.55	\$3.55	\$3.55	\$3.55	\$3.55	\$3.55

	2.3mm	2.4mm	2.5mm	2.6mm	2.7mm	2.8mm	2.9mm	3.0mm	3.1mm	3.3mm
12+	\$2.95	\$6.04	\$6.04	\$6.04	\$6.04	\$6.04	\$6.04	\$6.04	\$6.04	\$6.97
6+	\$3.20	\$6.39	\$6.39	\$6.39	\$6.39	\$6.39	\$6.39	\$6.39	\$6.39	\$7.38
1+	\$3.55	\$7.10	\$7.10	\$7.10	\$7.10	\$7.10	\$7.10	\$7.10	\$7.10	\$8.20

	3.5mm	3.7mm	4.0mm	4.2mm	4.5mm	4.7mm	5.0mm	5.5mm	6.0mm	6.5mm
12+	\$6.97	\$6.97	\$6.97	\$6.97	\$20.67	\$20.67	\$20.67	\$27.03	\$27.03	\$27.03
6+	\$7.38	\$7.38	\$7.38	\$7.38	\$22.41	\$22.41	\$22.41	\$28.62	\$28.62	\$28.62
1+	\$8.20	\$8.20	\$8.20	\$8.20	\$24.90	\$24.90	\$24.90	\$31.80	\$31.80	\$31.80

	7.0mm	7.5mm	8.0mm	8.5mm	9.0mm	9.5mm	10.0mm
12+	\$27.03	\$27.03	\$46.94	\$46.94	\$46.94	\$46.94	\$46.94
6+	\$28.62	\$28.62	\$50.90	\$50.90	\$50.90	\$50.90	\$50.90
1+	\$31.80	\$31.80	\$56.55	\$56.55	\$56.55	\$56.55	\$56.55



KRAUSE BURS, FIG. #256

Order # 77-10002
 Material Tungsten Vanadium Steel
 Head Shape Krause
 Shank Size 3/32"
 Sold in packs of 6

	1.0mm	1.2mm
12+	\$11.21	\$11.21
6+	\$12.15	\$12.15
1+	\$13.50	\$13.50





Order # 77-10004

Material Tungsten Vanadium Steel
 Head Shape 90° Bur
 Shank Size 3/32"
 Sold in packs of 6

	Kit Order #		
	77-1197	77-1198	77-1199
	Set of 12 (1 each)	Set of 12 (1 each)	Set of 24 (1 each)
	.50mm–2.5mm	3.1mm–8.0mm	.40mm–3.1mm
12+	\$20.02	\$21.20	\$23.55
6+	\$33.07	\$35.01	\$38.90
1+	\$46.07	\$48.78	\$54.20

	0.5mm	0.6mm	0.7mm	0.8mm	0.9mm	1.0mm	1.1mm	1.2mm	1.3mm	1.4mm
12+	\$7.69	\$7.69	\$7.69	\$7.69	\$7.69	\$7.69	\$7.69	\$7.69	\$7.69	\$7.69
6+	\$8.15	\$8.15	\$8.15	\$8.15	\$8.15	\$8.15	\$8.15	\$8.15	\$8.15	\$8.15
1+	\$9.05	\$9.05	\$9.05	\$9.05	\$9.05	\$9.05	\$9.05	\$9.05	\$9.05	\$9.05

	1.5mm	1.6mm	1.7mm	1.8mm	1.9mm	2.0mm	2.1mm	2.2mm	2.3mm	2.4mm
12+	\$7.69	\$7.69	\$7.69	\$7.69	\$7.69	\$7.69	\$7.69	\$7.69	\$7.69	\$11.82
6+	\$8.15	\$8.15	\$8.15	\$8.15	\$8.15	\$8.15	\$8.15	\$8.15	\$8.15	\$12.51
1+	\$9.05	\$9.05	\$9.05	\$9.05	\$9.05	\$9.05	\$9.05	\$9.05	\$9.05	\$13.90

	2.5mm	2.7mm	2.9mm	3.0mm	3.1mm	3.3mm	3.5mm	3.7mm	4.0mm	4.2mm
12+	\$11.82	\$11.82	\$11.82	\$11.82	\$11.82	\$11.82	\$11.82	\$17.09	\$17.09	\$17.09
6+	\$12.51	\$12.51	\$12.51	\$12.51	\$12.51	\$12.51	\$12.51	\$18.09	\$18.09	\$18.09
1+	\$13.90	\$13.90	\$13.90	\$13.90	\$13.90	\$13.90	\$13.90	\$20.10	\$20.10	\$20.10

	4.5mm	4.7mm	5.0mm
12+	\$17.09	\$17.09	\$17.09
6+	\$18.09	\$18.09	\$18.09
1+	\$20.10	\$20.10	\$20.10



90° HART BURS, FIG. #156C

Order # 77-10005

Material Tungsten Vanadium Steel
 Head Shape 70° Bur
 Shank Size 3/32"
 Sold in packs of 6

	Kit Order # 77-1299		
	Set of 12 Burs (1 each) 1.0mm–2.9mm		
	12+	6+	1+
	\$20.02	\$21.20	\$23.55

	0.9mm	1.0mm	1.1mm	1.2mm	1.3mm	1.4mm	1.5mm	1.6mm	1.7mm	1.8mm
12+	\$7.69	\$7.69	\$7.69	\$7.69	\$7.69	\$7.69	\$7.69	\$7.69	\$7.69	\$7.69
6+	\$8.15	\$8.15	\$8.15	\$8.15	\$8.15	\$8.15	\$8.15	\$8.15	\$8.15	\$8.15
1+	\$9.05	\$9.05	\$9.05	\$9.05	\$9.05	\$9.05	\$9.05	\$9.05	\$9.05	\$9.05

	1.9mm	2.0mm	2.1mm	2.2mm	2.3mm	2.5mm	2.7mm	2.9mm	3.1mm	3.3mm
12+	\$7.69	\$7.69	\$7.69	\$7.69	\$7.69	\$13.18	\$13.18	\$13.18	\$16.68	\$16.68
6+	\$8.15	\$8.15	\$8.15	\$8.15	\$8.15	\$13.95	\$13.95	\$13.95	\$18.09	\$18.09
1+	\$9.05	\$9.05	\$9.05	\$9.05	\$9.05	\$15.50	\$15.50	\$15.50	\$20.10	\$20.10

	3.5mm	3.7mm	4.7mm
12+	\$18.49	\$24.61	\$24.61
6+	\$19.30	\$26.69	\$26.69
1+	\$20.10	\$29.65	\$29.65



70° HART THIN BURS, FIG. #446



**KNIFE-EDGE CUT BURS,
FIG. #249**

Order # 77-10006

Material Tungsten Vanadium Steel
Head Shape Knife Edge
Shank Size 3/32"
Sold in packs of 6

Kit Order # 77-1398

Set of 12 Burs (1 each) .90mm–10.0mm

12+	6+	1+
\$37.02	\$39.20	\$43.55

	0.9mm	1.0mm	1.1mm	1.2mm	1.3mm	1.4mm	1.5mm	1.6mm	1.7mm	1.8mm
12+	\$7.69	\$7.69	\$7.69	\$7.69	\$7.69	\$7.69	\$7.69	\$7.69	\$7.69	\$7.69
6+	\$8.15	\$8.15	\$8.15	\$8.15	\$8.15	\$8.15	\$8.15	\$8.15	\$8.15	\$8.15
1+	\$9.05	\$9.05	\$9.05	\$9.05	\$9.05	\$9.05	\$9.05	\$9.05	\$9.05	\$9.05

	1.9mm	2.0mm	2.2mm	2.3mm	2.5mm	2.7mm	3.0mm	3.1mm	3.3mm	3.5mm
12+	\$7.69	\$7.69	\$7.69	\$7.69	\$11.82	\$11.82	\$11.82	\$11.82	\$11.82	\$11.82
6+	\$8.15	\$8.15	\$8.15	\$8.15	\$12.51	\$12.51	\$12.51	\$12.51	\$12.51	\$12.51
1+	\$9.05	\$9.05	\$9.05	\$9.05	\$13.90	\$13.90	\$13.90	\$13.90	\$13.90	\$13.90

	3.7mm	4.0mm	4.5mm	5.0mm	7.0mm	8.0mm	9.0mm	10.0mm
12+	\$17.09	\$17.09	\$17.09	\$17.09	\$24.52	\$24.52	\$42.08	\$42.08
6+	\$18.09	\$18.09	\$18.09	\$18.09	\$25.97	\$25.97	\$44.55	\$44.55
1+	\$20.10	\$20.10	\$20.10	\$20.10	\$28.85	\$28.85	\$49.50	\$49.50



**STONE SETTING BURS,
FIG. #413**

Order # 77-10007

Material Tungsten Vanadium Steel
Head Shape Setting
Shank Size 3/32"
Sold in packs of 6

Kit Order #

77-1497	77-1498	77-1499
Set of 12 (1 each) .50mm–2.5mm	Set of 12 (1 each) 3.1mm–8.0mm	Set of 24 (1 each) .40mm–3.1mm

12+	\$23.55	\$24.93	\$27.70
6+	\$39.02	\$41.31	\$45.90
1+	\$54.06	\$57.24	\$63.60

	0.9mm	1.0mm	1.2mm	1.3mm	1.4mm	1.5mm	1.6mm	1.7mm	1.8mm	1.9mm	2.0mm
12+	\$9.05	\$9.05	\$9.05	\$9.05	\$9.05	\$9.05	\$9.05	\$9.05	\$9.05	\$9.05	\$9.05
6+	\$9.59	\$9.59	\$9.59	\$9.59	\$9.59	\$9.59	\$9.59	\$9.59	\$9.59	\$9.59	\$9.59
1+	\$10.65	\$10.65	\$10.65	\$10.65	\$10.65	\$10.65	\$10.65	\$10.65	\$10.65	\$10.65	\$10.65

	2.1mm	2.2mm	2.3mm	2.4mm	2.5mm	2.7mm	2.9mm	3.0mm	3.1mm	3.3mm	3.5mm
12+	\$9.05	\$9.05	\$9.05	\$13.70	\$13.70	\$13.70	\$13.70	\$13.70	\$13.70	\$11.82	\$13.70
6+	\$9.59	\$9.59	\$9.59	\$14.85	\$14.85	\$14.85	\$14.85	\$14.85	\$14.85	\$12.51	\$14.85
1+	\$10.65	\$10.65	\$10.65	\$16.50	\$16.50	\$16.50	\$16.50	\$16.50	\$16.50	\$13.90	\$16.50

	3.7mm	4.0mm	4.2mm	4.5mm	4.7mm	5.0mm	6.0mm	7.0mm	8.0mm
12+	\$19.04	\$19.04	\$19.04	\$19.04	\$19.04	\$19.04	\$23.99	\$23.99	\$23.99
6+	\$20.16	\$20.16	\$20.16	\$20.16	\$20.16	\$20.16	\$26.01	\$26.01	\$26.01
1+	\$22.40	\$22.40	\$22.40	\$22.40	\$22.40	\$22.40	\$28.90	\$28.90	\$28.90





		1.5mm	2.0mm
	12+	\$9.31	\$9.31
	6+	\$9.86	\$9.86
	1+	\$10.95	\$10.95

Order # 77-10008
 Material Tungsten Vanadium Steel
 Head Shape Wheel
 Shank Size 3/32"
 Sold in packs of 6



WHEEL BURS, FIG. #431

		2.3mm	2.9mm	3.5mm	4.0mm
	12+	\$8.09	\$11.54	\$11.54	\$15.94
	6+	\$8.78	\$12.51	\$12.51	\$17.28
	1+	\$9.75	\$13.90	\$13.90	\$19.20

Order # 77-10010
 Material Tungsten Vanadium Steel
 Head Shape Wheel
 Shank Size 3/32"
 Sold in packs of 6

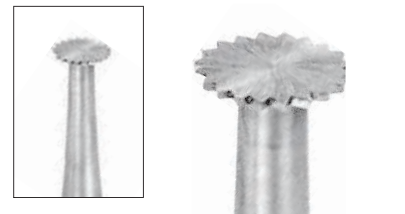

CIRCULAR EDGE BURS, FIG. #231S

Order # 77-10009
 Material Tungsten Vanadium Steel
 Head Shape Wheel
 Shank Size 3/32"
 Sold in packs of 6

Kit Order # 77-1740		
Set of 12 Burs (1 each) .60mm–2.5mm		
12+	6+	1+
\$7.57	\$8.01	\$8.90



WHEEL BURS, FIG. #2

	0.6mm	0.7mm	0.8mm	0.9mm	1.0mm	1.2mm	1.4mm
12+	\$2.95	\$2.95	\$2.95	\$2.95	\$2.95	\$2.95	\$3.53
6+	\$3.20	\$3.20	\$3.20	\$3.20	\$3.20	\$3.20	\$3.83
1+	\$3.55	\$3.55	\$3.55	\$3.55	\$3.55	\$3.55	\$4.25

	1.6mm	1.8mm	2.1mm	2.3mm	2.5mm	2.8mm
12+	\$3.20	\$3.20	\$3.20	\$3.53	\$6.29	\$6.29
6+	\$3.47	\$3.47	\$3.47	\$3.83	\$6.66	\$6.66
1+	\$3.85	\$3.85	\$3.85	\$4.25	\$7.40	\$7.40

Order # 77-10011
 Material Tungsten Vanadium Steel
 Head Shape Inverted Cone
 Shank Size 3/32"
 Sold in packs of 6

Kit Order # 77-1840		
Set of 12 Burs (1 each) .60mm–2.5mm		
12+	6+	1+
\$7.01	\$7.43	\$8.25



INVERTED CONE BURS, FIG. #3

	0.6mm	0.7mm	0.8mm	0.9mm	1.0mm	1.2mm	1.4mm
12+	\$3.20	\$3.20	\$3.20	\$3.20	\$3.20	\$3.20	\$3.20
6+	\$3.47	\$3.47	\$3.47	\$3.47	\$3.47	\$3.47	\$3.47
1+	\$3.85	\$3.85	\$3.85	\$3.85	\$3.85	\$3.85	\$3.85

	1.6mm	1.8mm	2.1mm	2.3mm	2.5mm	2.7mm	2.9mm
12+	\$3.20	\$3.20	\$3.20	\$3.20	\$8.46	\$7.82	\$7.82
6+	\$3.47	\$3.47	\$3.47	\$3.47	\$8.83	\$8.28	\$8.28
1+	\$3.85	\$3.85	\$3.85	\$3.85	\$9.20	\$9.20	\$9.20



Made in Germany. Panther® has earned a reputation for the highest standards in precision tool production in the world. Our burs and tools are manufactured on the most technically advanced computer assisted machinery in existence. Only the finest quality hardened tool steel is used. Each tool is individually hand inspected before leaving the factory. Our highly trained technicians take pride in producing the most exceptional, durable precision burs available anywhere. Once you experience the performance of a Panther® bur, you will never accept a substitute.



BUD CONICAL BURS, FIG. #79

Order #	77-10012
Material	Tungsten Vanadium Steel
Head Shape	Bud
Shank Size	3/32"
	Sold in packs of 6

	6	
	4.0mm	5.0mm
12+	\$15.85	\$17.00
6+	\$16.79	\$18.00
1+	\$18.65	\$20.00



CYLINDER CROSS-CUT BURS, FIG. #21

Order #	77-10013
Material	Tungsten Vanadium Steel
Head Shape	Cylinder
Shank Size	3/32"
	Sold in packs of 6

Kit Order # 77-2140		
Set of 12 Burs (1 each) .60mm–2.5mm		
12+	6+	1+
\$9.31	\$9.86	\$10.95

	0.6mm	0.7mm	0.8mm	0.9mm	1.0mm	1.2mm	1.4mm	1.6mm	1.8mm	2.1mm
12+	\$3.53	\$3.53	\$3.53	\$3.53	\$3.53	\$3.53	\$3.53	\$3.53	\$3.53	\$3.53
6+	\$3.74	\$3.74	\$3.74	\$3.74	\$3.74	\$3.74	\$3.74	\$3.74	\$3.74	\$3.74
1+	\$4.15	\$4.15	\$4.15	\$4.15	\$4.15	\$4.15	\$4.15	\$4.15	\$4.15	\$4.15

	2.3mm	2.5mm	2.7mm
12+	\$3.53	\$7.68	\$7.68
6+	\$3.74	\$8.32	\$8.32
1+	\$4.15	\$9.25	\$9.25

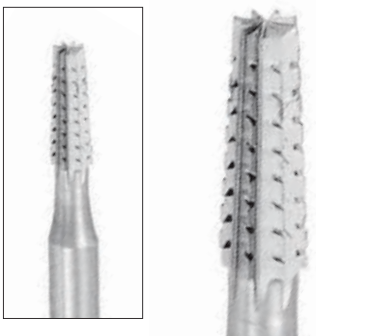

CONE SQUARE CROSS-CUT BURS, FIG. #23

Order #	77-10015
Material	Tungsten Vanadium Steel
Head Shape	Cone
Shank Size	3/32"
	Sold in packs of 6

Kit Order # 77-2240		
Set of 12 Burs (1 each) .60mm–2.5mm		
12+	6+	1+
\$8.59	\$9.09	\$10.10

	0.6mm	0.7mm	0.8mm	0.9mm	1.0mm	1.1mm	1.2mm	1.3mm	1.4mm	1.5mm
12+	\$3.53	\$3.53	\$3.53	\$3.53	\$3.53	\$3.53	\$3.53	\$3.53	\$3.53	\$3.53
6+	\$3.74	\$3.74	\$3.74	\$3.74	\$3.74	\$3.74	\$3.74	\$3.74	\$3.74	\$3.74
1+	\$4.15	\$4.15	\$4.15	\$4.15	\$4.15	\$4.15	\$4.15	\$4.15	\$4.15	\$4.15

	1.6mm	1.8mm	2.1mm	2.3mm	2.5mm
12+	\$4.04	\$4.04	\$4.04	\$4.04	\$7.59
6+	\$4.28	\$4.28	\$4.28	\$4.28	\$8.24
1+	\$4.75	\$4.75	\$4.75	\$4.75	\$9.15





Order # 77-10016

Material Tungsten Carbide Steel
 Head Shape Ball
 Shank Size 3/32"
 Sold in packs of 6

	0.3mm	0.4mm	0.5mm	0.6mm	0.7mm	0.8mm	0.9mm	1.0mm	1.1mm	1.2mm
12+	\$19.51	\$19.51	\$19.51	\$19.51	\$19.51	\$19.51	\$19.51	\$19.51	\$19.51	\$19.51
6+	\$21.15	\$21.15	\$21.15	\$21.15	\$21.15	\$21.15	\$21.15	\$21.15	\$21.15	\$21.15
1+	\$23.50	\$23.50	\$23.50	\$23.50	\$23.50	\$23.50	\$23.50	\$23.50	\$23.50	\$23.50

	1.3mm	1.4mm	1.5mm	1.6mm	1.7mm	1.8mm	1.9mm	2.0mm	2.1mm	2.2mm
12+	\$19.51	\$19.51	\$19.51	\$19.51	\$19.51	\$19.51	\$19.51	\$19.51	\$19.51	\$19.51
6+	\$21.15	\$21.15	\$21.15	\$21.15	\$21.15	\$21.15	\$21.15	\$21.15	\$21.15	\$21.15
1+	\$23.50	\$23.50	\$23.50	\$23.50	\$23.50	\$23.50	\$23.50	\$23.50	\$23.50	\$23.50

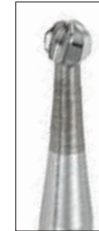

ROUND BURS, FIG. #H71



Order # 77-10018

Material Tungsten Carbide Steel
 Head Shape Cylinder
 Shank Size 3/32"
 Sold in packs of 6

	0.8mm	0.9mm	1.0mm
12+	\$19.51	\$19.51	\$19.51
6+	\$21.15	\$21.15	\$21.15
1+	\$23.50	\$23.50	\$23.50



TAPERED ROUND END BURS, FIG. H23RS



Order # 77-10019

Material Tungsten Carbide Steel
 Head Shape Cone
 Shank Size 3/32"
 Sold in packs of 6

	1.0mm	1.2mm	1.6mm
12+	\$19.51	\$19.51	\$19.51
6+	\$21.15	\$21.15	\$21.15
1+	\$23.50	\$23.50	\$23.50



CONE ROUND BURS, FIG. #H23R



Order # 77-10020

Material Tungsten Carbide Steel
 Head Shape Cylinder
 Shank Size 3/32"
 Sold Each

	0.9mm	1.0mm	1.2mm	1.4mm
12+	\$18.51	\$18.51	\$18.51	\$18.51
6+	\$20.07	\$20.07	\$20.07	\$20.07
1+	\$22.30	\$22.30	\$22.30	\$22.30



CYLINDER LONG BURS, FIG. #21L



Order # 77-10017

Material Tungsten Carbide Steel
 Head Shape Wheel
 Shank Size 3/32"
 Sold in packs of 6

	1.4mm
12+	\$19.51
6+	\$21.15
1+	\$23.50



WHEEL BURS, FIG. #H3



Made in Germany, Panther® has earned a reputation for the highest standards in precision tool production in the world. Our burs and tools are manufactured on the most technically advanced computer assisted machinery in existence. Only the finest quality hardened tool steel is used. Each tool is individually hand inspected before leaving the factory. Our highly trained technicians take pride in producing the most exceptional, durable precision burs available anywhere. Once you experience the performance of a Panther® bur, you will never accept a substitute.



**CONE ROUND CROSS-CUT
EXTRA FINE BURS, FIG. H33 FRS**

Order # 77-10023

Material Tungsten Carbide Steel
Head Shape Round
Shank Size 3/32"
Sold in packs of 6

	0.9mm	1.0mm
12+	\$33.16	\$33.16
6+	\$35.96	\$35.96
1+	\$39.95	\$39.95



CONE SQUARE BURS, FIG. #H23

Order # 77-10024

Material Tungsten Carbide Steel
Head Shape Cone
Shank Size 3/32"
Sold in packs of 6

	0.9mm	1.2mm
12+	\$19.51	\$19.51
6+	\$21.15	\$21.15
1+	\$23.50	\$23.50



CONE SQUARE BURS, FIG. #H23L

Order # 77-10025

Material Tungsten Carbide Steel
Head Shape Cone
Shank Size 3/32"
Sold in packs of 6

	1.0mm	1.2mm	1.6mm
12+	\$18.51	\$18.51	\$18.51
6+	\$20.07	\$20.07	\$20.07
1+	\$22.30	\$22.30	\$22.30



**CONE SQUARE CROSS-CUT
BURS, FIG. #H33**

Order # 77-10025

Material Tungsten Carbide Steel
Head Shape Cone
Shank Size 3/32"
Sold in packs of 6

	0.9mm	1.0mm	1.2mm	1.4mm	1.6mm	2.1mm
12+	\$18.51	\$18.51	\$18.51	\$18.51	\$18.51	\$18.51
6+	\$20.07	\$20.07	\$20.07	\$20.07	\$20.07	\$20.07
1+	\$22.30	\$22.30	\$22.30	\$22.30	\$22.30	\$22.30



Order # 77-10027
 Material Tungsten Carbide Steel
 Head Shape Cone
 Shank Size 3/32"
 Sold in packs of 6



CONE ROUND CROSS-CUT BURS, FIG. #H23RSE

	0.9mm	1.0mm
12+	\$28.30	\$28.30
6+	\$30.69	\$30.69
1+	\$34.10	\$34.10

Order # 77-10030
 Material Tungsten Carbide Steel
 Head Shape Cone
 Shank Size 3/32"
 Sold in packs of 6



CONE SQUARE CROSS-CUT LONG BURS, FIG. #H33L

	0.9mm	1.0mm	1.2mm	1.6mm	2.1mm
12+	\$18.51	\$18.51	\$18.51	\$18.51	\$18.51
6+	\$20.07	\$20.07	\$20.07	\$20.07	\$20.07
1+	\$22.30	\$22.30	\$22.30	\$22.30	\$22.30

Order # 77-10028
 Material Tungsten Carbide Steel
 Head Shape Inverted Cone
 Shank Size 3/32"
 Sold in packs of 6



INVERTED CONE BURS, FIG. #H30

	0.6mm	0.8mm	0.9mm	1.0mm	1.2mm	1.4mm	1.6mm
12+	\$21.46	\$21.46	\$21.46	\$21.46	\$21.46	\$21.46	\$21.46
6+	\$23.27	\$23.27	\$23.27	\$23.27	\$23.27	\$23.27	\$23.27
1+	\$25.85	\$25.85	\$25.85	\$25.85	\$25.85	\$25.85	\$25.85

Order # 77-10026
 Material Tungsten Carbide Steel
 Head Shape Cylinder
 Shank Size 3/32"
 Sold in packs of 6



CYLINDER PLAIN BURS, FIG. #H21

	0.8mm	0.9mm	1.0mm	1.2mm	1.4mm	1.6mm	1.8mm
12+	\$18.51	\$18.14	\$18.51	\$18.51	\$18.51	\$18.51	\$18.51
6+	\$20.07	\$19.67	\$20.07	\$20.07	\$20.07	\$20.07	\$20.07
1+	\$22.30	\$21.85	\$22.30	\$22.30	\$22.30	\$22.30	\$22.30

Order # 77-10029
 Material Tungsten Carbide Steel
 Head Shape Cylinder
 Shank Size 3/32"
 Sold in packs of 6



CYLINDER CROSS-CUT BURS, FIG. #31

	0.8mm	0.9mm	1.0mm	1.2mm	1.4mm	1.6mm	1.8mm
12+	\$18.09	\$18.09	\$18.09	\$18.09	\$18.09	\$18.09	\$18.09
6+	\$19.62	\$19.62	\$19.62	\$19.62	\$19.62	\$19.62	\$19.62
1+	\$21.80	\$21.80	\$21.80	\$21.80	\$21.80	\$21.80	\$21.80



PANTHER CUP BURS, FIG. #77B

Order # 77-10031
 Material Tungsten Vanadium Steel
 Head Shape Cup
 Shank Size 3/32"
 Sold in packs of 6

	Kit Order #	
	77-2898	77-2899
	Set of 12 (1 each) 1.0mm–2.9mm	Set of 18 (1 each) .80mm–2.9mm
12+	\$21.51	\$22.77
6+	\$25.30	\$31.03
1+	\$32.85	\$36.50

	0.8mm	0.9mm	1.0mm	1.1mm	1.2mm	1.3mm	1.4mm	1.5mm	1.6mm	1.7mm
12+	\$7.69	\$7.69	\$7.69	\$7.69	\$7.69	\$7.69	\$7.69	\$7.69	\$7.69	\$7.69
6+	\$8.15	\$8.15	\$8.15	\$8.15	\$8.15	\$8.15	\$8.15	\$8.15	\$8.15	\$8.15
1+	\$9.05	\$9.05	\$9.05	\$9.05	\$9.05	\$9.05	\$9.05	\$9.05	\$9.05	\$9.05

	1.8mm	1.9mm	2.0mm	2.1mm	2.3mm	2.5mm	2.7mm	2.9mm	3.0mm	3.5mm
12+	\$7.69	\$7.69	\$7.69	\$7.69	\$7.69	\$13.70	\$13.70	\$13.70	\$16.02	\$16.02
6+	\$8.15	\$8.15	\$8.15	\$8.15	\$8.15	\$14.85	\$14.85	\$14.85	\$16.97	\$16.97
1+	\$9.05	\$9.05	\$9.05	\$9.05	\$9.05	\$16.50	\$16.50	\$16.50	\$18.85	\$18.85

	4.0mm	4.5mm	5.0mm
12+	\$24.01	\$24.01	\$24.01
6+	\$25.43	\$25.43	\$25.43
1+	\$28.25	\$28.25	\$28.25

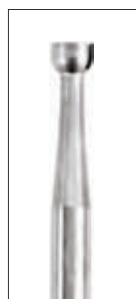

PANTHER SPECIAL CUP BURS,
FIG. #256A

Order # 77-10032
 Material Tungsten Vanadium Steel
 Head Shape Cup
 Shank Size 3/32"
 Sold in packs of 6

	0.8mm	0.9mm	1.0mm	1.1mm	1.2mm	1.3mm	1.4mm	1.5mm	1.6mm	1.7mm
12+	\$11.26	\$11.26	\$11.26	\$11.26	\$11.26	\$11.26	\$11.26	\$11.26	\$11.26	\$11.26
6+	\$11.93	\$11.93	\$11.93	\$11.93	\$11.93	\$11.93	\$11.93	\$11.93	\$11.93	\$11.93
1+	\$13.25	\$13.25	\$13.25	\$13.25	\$13.25	\$13.25	\$13.25	\$13.25	\$13.25	\$13.25

	1.8mm	2.1mm	2.3mm
12+	\$11.26	\$11.26	\$11.26
6+	\$11.93	\$11.93	\$11.93
1+	\$13.25	\$13.25	\$13.25



PANTHER SPECIAL CONICAL CUP
BURS, FIG. #256S

Order # 77-10033
 Material Tungsten Vanadium Steel
 Head Shape Cup
 Shank Size 3/32"
 Sold in packs of 6

	0.8mm	1.0mm	1.6mm	1.8mm
12+	\$11.26	\$11.26	\$11.26	\$11.26
6+	\$11.93	\$11.93	\$11.93	\$11.93
1+	\$13.25	\$13.25	\$13.25	\$13.25





Made in Germany. Panther® has earned a reputation for the highest standards in precision tool production in the world. Our burs and tools are manufactured on the most technically advanced computer assisted machinery in existence. Only the finest quality hardened tool steel is used. Each tool is individually hand inspected before leaving the factory. Our highly trained technicians take pride in producing the most exceptional, durable precision burs available anywhere. Once you experience the performance of a Panther® bur, you will never accept a substitute.

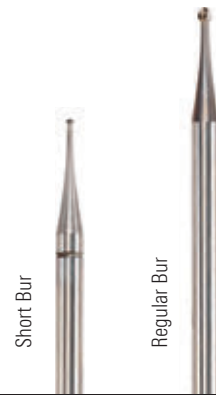

<p>Order # 77-10035</p> <p>Material Tungsten Vanadium Steel Head Shape Round Shank Size 3/32" Sold in packs of 6</p>		<p>Kit Order # 77-1001S</p> <table border="1"> <thead> <tr> <th></th> <th>Set of 10 (1 each) .50mm–1.4mm</th> <th>Set of 20 (2 each) .50mm–1.4mm</th> </tr> </thead> <tbody> <tr> <td>12+</td> <td>\$6.97</td> <td>\$13.01</td> </tr> <tr> <td>6+</td> <td>\$7.38</td> <td>\$13.77</td> </tr> <tr> <td>1+</td> <td>\$8.20</td> <td>\$15.30</td> </tr> </tbody> </table>		Set of 10 (1 each) .50mm–1.4mm	Set of 20 (2 each) .50mm–1.4mm	12+	\$6.97	\$13.01	6+	\$7.38	\$13.77	1+	\$8.20	\$15.30
	Set of 10 (1 each) .50mm–1.4mm	Set of 20 (2 each) .50mm–1.4mm												
12+	\$6.97	\$13.01												
6+	\$7.38	\$13.77												
1+	\$8.20	\$15.30												

	0.5mm	0.6mm	0.7mm	0.8mm	0.9mm	1mm	1.1mm	1.2mm	1.3mm	1.4mm
12+	\$4.03	\$4.03	\$4.03	\$4.03	\$4.03	\$4.03	\$4.03	\$4.03	\$4.03	\$4.03
6+	\$4.37	\$4.37	\$4.37	\$4.37	\$4.37	\$4.37	\$4.37	\$4.37	\$4.37	\$4.37
1+	\$4.85	\$4.85	\$4.85	\$4.85	\$4.85	\$4.85	\$4.85	\$4.85	\$4.85	\$4.85

PANTHER SHORT ROUND BURS

<p>Order # 77-10036</p> <p>Material Tungsten Vanadium Steel Head Shape 90° Bur Shank Size 3/32" Sold in packs of 6</p>		<p>Kit Order # 77-1002S</p> <table border="1"> <thead> <tr> <th></th> <th>Set of 8 (1 each) 09mm–1.6mm</th> <th>Set of 16 (2 each) 09mm–1.6mm</th> </tr> </thead> <tbody> <tr> <td>12+</td> <td>\$13.90</td> <td>\$25.16</td> </tr> <tr> <td>6+</td> <td>\$14.72</td> <td>\$26.64</td> </tr> <tr> <td>1+</td> <td>\$16.35</td> <td>\$29.60</td> </tr> </tbody> </table>		Set of 8 (1 each) 09mm–1.6mm	Set of 16 (2 each) 09mm–1.6mm	12+	\$13.90	\$25.16	6+	\$14.72	\$26.64	1+	\$16.35	\$29.60
	Set of 8 (1 each) 09mm–1.6mm	Set of 16 (2 each) 09mm–1.6mm												
12+	\$13.90	\$25.16												
6+	\$14.72	\$26.64												
1+	\$16.35	\$29.60												

	0.9mm	1mm	1.1mm	1.2mm	1.3mm	1.4mm	1.5mm	1.6mm
12+	\$10.03	\$10.03	\$10.03	\$10.03	\$10.03	\$10.03	\$10.03	\$10.03
6+	\$10.62	\$10.62	\$10.62	\$10.62	\$10.62	\$10.62	\$10.62	\$10.62
1+	\$11.80	\$11.80	\$11.80	\$11.80	\$11.80	\$11.80	\$11.80	\$11.80

PANTHER SHORT 90° HART BUR

<p>Order # 77-10037</p> <p>Material Tungsten Vanadium Steel Head Shape 70° Bur Shank Size 3/32" Sold in packs of 6</p>		<p>Kit Order # 77-1003S</p> <table border="1"> <thead> <tr> <th></th> <th>Set of 8 (1 each) .09mm–1.6mm</th> <th>Set of 16 (2 each) .09mm–1.6mm</th> </tr> </thead> <tbody> <tr> <td>12+</td> <td>\$13.90</td> <td>\$25.16</td> </tr> <tr> <td>6+</td> <td>\$14.72</td> <td>\$26.64</td> </tr> <tr> <td>1+</td> <td>\$16.35</td> <td>\$29.60</td> </tr> </tbody> </table>		Set of 8 (1 each) .09mm–1.6mm	Set of 16 (2 each) .09mm–1.6mm	12+	\$13.90	\$25.16	6+	\$14.72	\$26.64	1+	\$16.35	\$29.60
	Set of 8 (1 each) .09mm–1.6mm	Set of 16 (2 each) .09mm–1.6mm												
12+	\$13.90	\$25.16												
6+	\$14.72	\$26.64												
1+	\$16.35	\$29.60												

	0.9mm	1mm	1.1mm	1.2mm	1.3mm	1.4mm	1.5mm	1.6mm
12+	\$10.03	\$10.03	\$10.03	\$10.03	\$10.03	\$10.03	\$10.03	\$10.03
6+	\$10.62	\$10.62	\$10.62	\$10.62	\$10.62	\$10.62	\$10.62	\$10.62
1+	\$11.80	\$11.80	\$11.80	\$11.80	\$11.80	\$11.80	\$11.80	\$11.80

PANTHER SHORT 70° HART BUR



BUSCH® MASTER KIT 84 PIECE KIT

Busch® Master Kit contains an assortment of Round, 70° hart, 90° hart, bud, inverted cone, cylinder square, and setting burs, displayed in a wooden storage box. These German burs are made of exceptional quality and known for their precision which allows for accurate and smooth cutting.

Order #	Set of	Description	12+	6+	1+
19-3220	97	Master Bur Kit	\$255.31	\$276.84	\$307.60

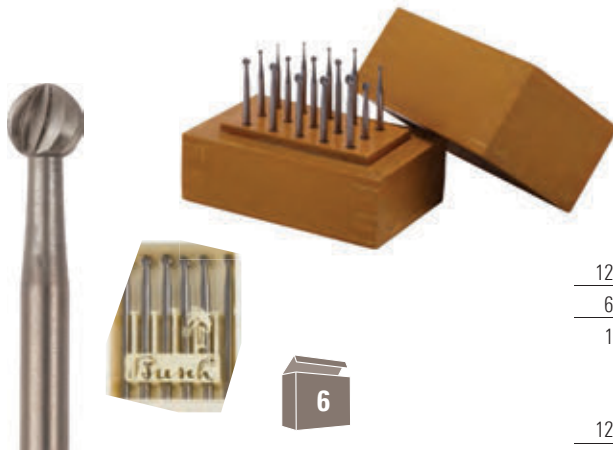

ROUND, FIG. #1

Order #	18-10000	Kit Order # 18-1886
Material	Tungsten Vanadium Steel	15-Piece Bur Kit (1 each) 1.0mm–3.1mm
Head Shape	Ball	
Shank Size	3/32"	
	Sold in packs of 6	
		12+ 6+ 1+
		\$35.70 \$37.25 \$38.80

	0.25mm	0.3mm	0.35mm	0.4mm	0.5mm	0.6mm	0.7mm	0.8mm
12+	\$17.11	\$17.39	\$16.07	\$9.29	\$5.40	\$5.40	\$5.40	\$5.40
6+	\$17.86	\$18.14	\$17.01	\$9.70	\$5.72	\$5.72	\$5.72	\$5.72
1+	\$18.60	\$18.90	\$18.90	\$10.10	\$6.35	\$6.35	\$6.35	\$6.35

	0.9mm	1.0mm	1.1mm	1.2mm	1.3mm	1.4mm	1.5mm	1.6mm
12+	\$5.40	\$5.40	\$5.40	\$5.40	\$5.40	\$5.40	\$5.40	\$5.40
6+	\$5.72	\$5.72	\$5.72	\$5.72	\$5.72	\$5.72	\$5.72	\$5.72
1+	\$6.35	\$6.35	\$6.35	\$6.35	\$6.35	\$6.35	\$6.35	\$6.35

	1.7mm	1.8mm	1.95mm	2.1mm	2.2mm	2.3mm	2.4mm	2.5mm	2.6mm	2.7mm	2.9mm	3.1mm	3.3mm	3.5mm
12+	\$5.40	\$5.40	\$5.40	\$5.40	\$5.40	\$5.40	\$11.27	\$11.27	\$11.27	\$11.27	\$11.27	\$17.85	\$17.85	\$17.85
6+	\$5.72	\$5.72	\$5.72	\$5.72	\$5.72	\$5.72	\$11.76	\$11.76	\$11.76	\$11.76	\$11.76	\$18.62	\$18.62	\$18.62
1+	\$6.35	\$6.35	\$6.35	\$6.35	\$6.35	\$6.35	\$12.25	\$12.25	\$12.25	\$12.25	\$12.25	\$19.40	\$19.40	\$19.40

	3.7mm	4.0mm	4.2mm	4.5mm	4.7mm	5.0mm	5.5mm	6.0mm	6.5mm	7.0mm	7.5mm	8.0mm	8.5mm
12+	\$17.85	\$20.19	\$20.19	\$20.19	\$20.19	\$20.19	\$5.91	\$5.91	\$5.91	\$5.91	\$7.18	\$7.18	\$7.18
6+	\$18.62	\$21.38	\$21.38	\$21.38	\$21.38	\$21.38	\$6.26	\$6.26	\$6.26	\$6.26	\$7.61	\$7.61	\$7.61
1+	\$19.40	\$23.75	\$23.75	\$23.75	\$23.75	\$23.75	\$6.95	\$6.95	\$6.95	\$6.95	\$8.45	\$8.45	\$8.45



70° BEARING, FIG. #446

Order #	18-10001
Material	Tungsten Vanadium Steel
Head Shape	70° Bur
Shank Size	3/32"
	Sold in packs of 6

	1.0mm	1.2mm	1.4mm	1.6mm	1.8mm	2.1mm	2.3mm	2.5mm	2.7mm	2.9mm
12+	\$14.17	\$14.17	\$14.17	\$14.17	\$14.17	\$14.17	\$14.17	\$21.99	\$21.99	\$21.99
6+	\$14.78	\$14.78	\$14.78	\$14.78	\$14.78	\$14.78	\$14.78	\$22.94	\$22.94	\$22.94
1+	\$15.40	\$15.40	\$15.40	\$15.40	\$15.40	\$15.40	\$15.40	\$23.90	\$23.90	\$23.90

	3.1mm	3.3mm	3.5mm	3.7mm	4.0mm	4.2mm	4.5mm	4.7mm	5.0mm
12+	\$26.31	\$26.31	\$26.31	\$26.31	\$32.71	\$32.71	\$32.71	\$32.71	\$35.10
6+	\$27.46	\$27.46	\$27.46	\$27.46	\$34.13	\$34.13	\$34.13	\$34.13	\$36.62
1+	\$28.60	\$28.60	\$28.60	\$28.60	\$35.55	\$35.55	\$35.55	\$35.55	\$38.15



BUSCH® TWINCUT CONICAL CUP BUR KIT

Concave cutter with outstanding Twincut blade geometry. Designed for quick and precise working of rounding-off, smoothing, and shortening of prong settings in one single operation.

Order #	Set of	Description	12+	6+	1+
18-5005	12	1 each: 1.0-3.1	\$45.05	\$47.70	\$53.00



Order # 18-10014

Material Tungsten Vanadium Steel
 Head Shape Cup
 Shank Size 3/32"
 Sold in packs of 6

	0.8mm	0.9mm	1mm	1.1mm	1.2mm	1.3mm	1.4mm	1.5mm	1.6mm	1.7mm
12+	\$17.64	\$17.64	\$17.64	\$17.64	\$17.64	\$17.64	\$17.64	\$17.64	\$17.64	\$17.64
6+	\$18.68	\$18.68	\$18.68	\$18.68	\$18.68	\$18.68	\$18.68	\$18.68	\$18.68	\$18.68
1+	\$20.75	\$20.75	\$20.75	\$20.75	\$20.75	\$20.75	\$20.75	\$20.75	\$20.75	\$20.75

	1.8mm	1.9mm	2mm	2.1mm	2.2mm	2.3mm
12+	\$17.64	\$17.64	\$17.64	\$17.64	\$17.64	\$17.64
6+	\$18.68	\$18.68	\$18.68	\$18.68	\$18.68	\$18.68
1+	\$20.75	\$20.75	\$20.75	\$20.75	\$20.75	\$20.75



BUSCH TWINCUT CUP BUR

Order # 18-10015

Material Tungsten Vanadium Steel
 Head Shape Cup
 Shank Size 3/32"
 Sold in packs of 6

	0.8mm	0.9mm	1mm	1.1mm	1.2mm	1.3mm	1.4mm	1.5mm	1.6mm	1.7mm
12+	\$19.09	\$19.09	\$19.09	\$19.09	\$19.09	\$19.09	\$19.09	\$19.09	\$19.09	\$19.09
6+	\$19.92	\$19.92	\$19.92	\$19.92	\$19.92	\$19.92	\$19.92	\$19.92	\$19.92	\$19.92
1+	\$20.75	\$20.75	\$20.75	\$20.75	\$20.75	\$20.75	\$20.75	\$20.75	\$20.75	\$20.75

	1.8mm	1.9mm	2mm	2.1mm	2.2mm	2.3mm
12+	\$19.09	\$19.09	\$19.09	\$19.09	\$19.09	\$19.09
6+	\$19.92	\$19.92	\$19.92	\$19.92	\$19.92	\$19.92
1+	\$20.75	\$20.75	\$20.75	\$20.75	\$20.75	\$20.75



BUSCH TWINCUT CONICAL CUP BUR



BUD BUR, FIG. #6

Order # 18-10003

Material Tungsten Vanadium Steel
 Head Shape Bud
 Shank Size 3/32"
 Sold in packs of 6

	0.6mm	0.7mm	0.8mm	0.9mm	1.0mm	1.2mm	1.4mm	1.6mm	1.8mm	2.1mm
12+	\$5.99	\$5.99	\$5.99	\$5.99	\$5.99	\$5.99	\$5.99	\$5.99	\$5.99	\$5.99
6+	\$6.35	\$6.35	\$6.35	\$6.35	\$6.35	\$6.35	\$6.35	\$6.35	\$6.35	\$6.35
1+	\$7.05	\$7.05	\$7.05	\$7.05	\$7.05	\$7.05	\$7.05	\$7.05	\$7.05	\$7.05

	2.3mm	2.5mm	2.7mm	2.9mm	3.1mm	3.3mm	3.5mm	3.7mm	4.0mm
12+	\$5.99	\$12.79	\$12.79	\$12.79	\$17.98	\$17.98	\$17.98	\$17.98	\$23.46
6+	\$6.35	\$13.55	\$13.55	\$13.55	\$19.04	\$19.04	\$19.04	\$19.04	\$24.48
1+	\$7.05	\$15.05	\$15.05	\$15.05	\$21.15	\$21.15	\$21.15	\$21.15	\$25.50



STONE SETTING BURS, FIG. #413

Order # 18-10005

Material Tungsten Vanadium Steel
 Head Shape Setting
 Shank Size 3/32"
 Sold in packs of 6

Kit Order # 18-4075

Set of 16 (1 each) 1.0mm–8.0mm

12+	6+	1+
\$87.40	\$91.20	\$95.00

	1.0mm	1.25mm	1.5mm	1.75mm	2.0mm	2.25mm	2.5mm	2.75mm	3.0mm	3.25mm	3.5mm
12+	\$2.64	\$2.64	\$2.68	\$2.55	\$2.55	\$2.55	\$3.91	\$3.61	\$4.76	\$4.76	\$4.76
6+	\$2.79	\$2.79	\$2.84	\$2.70	\$2.70	\$2.70	\$4.08	\$3.83	\$5.04	\$5.04	\$5.04
1+	\$3.10	\$3.10	\$3.15	\$3.00	\$3.00	\$3.00	\$4.25	\$4.25	\$5.60	\$4.76	\$5.60

	3.75mm	4.0mm	4.25mm	4.5mm	4.75mm	5.0mm	5.5mm	6.0mm	7.0mm	8.0mm
12+	\$4.76	\$6.39	\$6.81	\$6.39	\$6.39	\$6.39	\$7.23	\$7.23	\$7.23	\$8.41
6+	\$5.04	\$6.67	\$7.10	\$6.67	\$6.67	\$6.67	\$7.65	\$7.65	\$7.65	\$8.91
1+	\$5.60	\$6.95	\$7.40	\$6.95	\$6.95	\$6.95	\$8.50	\$8.50	\$8.50	\$9.90



CONE, SQUARE CROSS-CUT, FIG. #23

Order # 18-10002

Material Tungsten Vanadium Steel
 Head Shape Cylinder
 Shank Size 3/32"
 Sold in packs of 6

	0.7mm	0.8mm	0.9mm	1.0mm	1.2mm	1.4mm	1.6mm	1.8mm	2.1mm	2.3mm
12+	\$8.69	\$8.69	\$8.69	\$8.69	\$8.69	\$8.69	\$8.69	\$8.69	\$8.69	\$15.85
6+	\$9.07	\$9.07	\$9.07	\$9.07	\$9.07	\$9.07	\$9.07	\$9.07	\$9.07	\$16.79
1+	\$9.45	\$9.45	\$9.45	\$9.45	\$9.45	\$9.45	\$9.45	\$9.45	\$9.45	\$18.65

	2.5mm	2.7mm	2.9mm	3.1mm
12+	\$15.81	\$15.85	\$15.81	\$19.46
6+	\$16.74	\$16.79	\$16.74	\$20.30
1+	\$18.60	\$18.65	\$18.60	\$21.15





Order # 18-10007

Material Tungsten Vanadium Steel
 Head Shape Inverted Cone
 Shank Size 3/32"
 Sold in packs of 6

	0.6mm	0.7mm	0.8mm	0.9mm	1.0mm	1.2mm	1.4mm	1.6mm	1.8mm
12+	\$5.40	\$5.40	\$5.40	\$5.40	\$5.40	\$5.40	\$5.40	\$5.40	\$5.40
6+	\$5.72	\$5.72	\$5.72	\$5.72	\$5.72	\$5.72	\$5.72	\$5.72	\$5.72
1+	\$6.35	\$6.35	\$6.35	\$6.35	\$6.35	\$6.35	\$6.35	\$6.35	\$6.35

	2.1mm	2.3mm	2.7mm
12+	\$5.40	\$5.40	\$10.80
6+	\$5.72	\$5.72	\$11.43
1+	\$6.35	6.35	\$12.70



INVERTED CONE, FIG. #3

Order # 18-10009

Material Tungsten Vanadium Steel
 Head Shape 90° Bur
 Shank Size 3/32"
 Sold in packs of 6



Kit Order #		
A. 18-5052	B. 18-5057	
Set of 12 (1 each)	Set of 6 (1 each)	
1.0mm–3.1mm	3.3mm–4.5mm	
12+	\$35.70	\$37.25
6+	\$38.80	\$29.50
1+	\$31.23	\$34.70

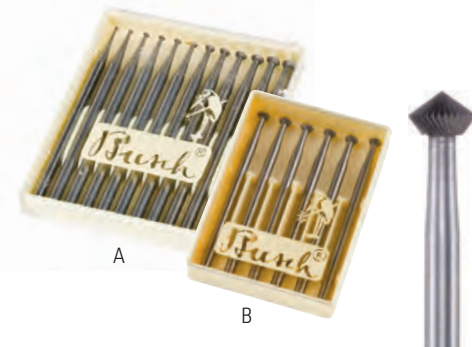

90° HART, FIG. #156C

	0.9mm	1.0mm	1.2mm	1.4mm	1.5mm	1.6mm	1.7mm	1.8mm	1.9mm	2.0mm	2.1mm	2.2mm	2.3mm	2.4mm
12+	\$14.11	\$14.11	\$14.11	\$14.11	\$14.11	\$14.11	\$14.11	\$14.11	\$14.11	\$14.11	\$14.11	\$14.11	\$14.11	\$21.21
6+	\$14.94	\$14.94	\$14.94	\$14.94	\$14.94	\$14.94	\$14.94	\$14.94	\$14.94	\$14.94	\$14.94	\$14.94	\$14.94	\$22.46
1+	\$16.60	\$16.60	\$16.60	\$16.60	\$16.60	\$16.60	\$16.60	\$16.60	\$16.60	\$16.60	\$16.60	\$16.60	\$16.60	\$24.95

	2.5mm	2.6mm	2.7mm	2.8mm	2.9mm	3.1mm	3.3mm	3.5mm	3.7mm	4.0mm	4.2mm	4.5mm	4.7mm	5.0mm
12+	\$21.21	\$21.21	\$21.21	\$21.21	\$21.21	\$27.83	\$27.83	\$27.83	\$27.83	\$33.81	\$33.81	\$33.81	\$33.81	\$33.81
6+	\$22.46	\$22.46	\$22.46	\$22.46	\$22.46	\$29.04	\$29.04	\$29.04	\$29.04	\$35.28	\$35.28	\$35.28	\$35.28	\$35.28
1+	\$24.95	\$24.95	\$24.95	\$24.95	\$24.95	\$30.25	\$30.25	\$30.25	\$30.25	\$36.75	\$36.75	\$36.75	\$36.75	\$36.75



	1.0mm	1.2mm
12+	\$17.72	\$17.72
6+	\$18.77	\$18.77
1+	\$20.85	\$20.85

Order # 18-10006

Material Tungsten Vanadium Steel
 Head Shape Krause
 Shank Size 3/32"
 Sold in packs of 6



KRAUSE BURS, FIG. #256



CYLINDER, SPECIAL CROSS-CUT, FIG. #21

Order # 18-10008
 Material Tungsten Vanadium Steel
 Head Shape Cylinder
 Shank Size 3/32"
 Sold in packs of 6

	0.6mm	0.7mm	0.8mm	0.9mm	1.0mm	1.2mm	1.4mm	1.6mm	1.8mm	2.1mm
12+	\$8.03	\$8.03	\$8.03	\$8.03	\$8.03	\$8.03	\$8.03	\$8.03	\$8.03	\$8.03
6+	\$8.51	\$8.51	\$8.51	\$8.51	\$8.51	\$8.51	\$8.51	\$8.51	\$8.51	\$8.51
1+	\$9.45	\$9.45	\$9.45	\$9.45	\$9.45	\$9.45	\$9.45	\$9.45	\$9.45	\$9.45

	2.3mm	2.5mm	2.7mm	2.9mm	3.1mm
12+	\$8.03	\$19.85	\$15.85	\$15.81	\$19.46
6+	\$8.51	\$21.02	\$16.79	\$16.74	\$20.30
1+	\$9.45	\$23.35	\$18.65	\$18.60	\$21.15



CYLINDER, SPECIAL SINGLE-CUT, FIG. #15

Order # 18-10004
 Material Tungsten Vanadium Steel
 Head Shape Cylinder
 Shank Size 3/32"
 Sold in packs of 6

	0.7mm	0.8mm	0.9mm	1.0mm	1.2mm	1.4mm	1.6mm	1.8mm	2.1mm	2.3mm	3.1mm
12+	\$8.33	\$8.33	\$8.33	\$8.33	\$8.33	\$8.33	\$8.33	\$8.33	\$8.33	\$8.33	\$17.98
6+	\$8.69	\$8.69	\$8.69	\$8.69	\$8.69	\$8.69	\$8.69	\$8.69	\$8.69	\$8.69	\$19.04
1+	\$9.05	\$9.05	\$9.05	\$9.05	\$9.05	\$9.05	\$9.05	\$9.05	\$9.05	\$9.05	\$21.15



BUSCH® KNIFE EDGE WHEEL BUR

Order # 18-10010
 Material Tungsten Vanadium Steel
 Head Shape Wheel
 Shank Size 3/32"
 Sold Each

	6.0mm	7.0mm	8.0mm	10.0mm	12.0mm	14.0mm
12+	\$13.94	\$13.94	\$15.81	\$20.32	\$24.93	\$24.93
6+	\$14.76	\$14.76	\$16.74	\$21.51	\$26.02	\$26.02
1+	\$16.40	\$16.40	\$18.60	\$23.90	\$27.10	\$27.10



BUSCH® WHEEL BUR WITH SAW EDGE, FIG. #231S

Order # 18-10011
 Material Tungsten Vanadium Steel
 Head Shape Wheel
 Shank Size 3/32"
 Sold Each

	2.3mm	4.0mm	5.0mm	6.0mm	8.0mm	10mm
12+	\$2.25	\$5.91	\$5.91	\$9.52	\$11.31	\$12.20
6+	\$2.38	\$6.26	\$6.26	\$10.08	\$11.97	\$12.92
1+	\$2.65	\$6.95	\$6.95	\$11.20	\$13.30	\$14.35



Order # 18-10013

Material Tungsten Vanadium Steel
 Head Shape Cup
 Shank Size 3/32"
 Sold Each

	1.0mm	1.5mm	1.6mm	1.8mm	2.1mm	2.3mm
12+	\$2.90	\$2.90	\$2.90	\$2.90	\$2.90	\$2.90
6+	\$3.02	\$3.02	\$3.02	\$3.02	\$3.02	\$3.02
1+	\$3.15	\$3.15	\$3.15	\$3.15	\$3.15	\$3.15



BUSCH® FAST-CUT CUP BURS, FIG. #411C

Order # 18-10016

Material Tungsten Vanadium Steel
 Head Shape Cup
 Shank Size 3/32"
 Sold Each

Kit Order # 18-1530

Set of 13 Burs
 (1 each) 0.9mm-3.1mm

12+	6+	1+
\$45.82	\$47.81	\$49.80

	0.9mm	1.0mm	1.2mm	1.4mm	1.5mm	1.6mm	1.8mm
12+	\$2.72	\$2.72	\$2.72	\$2.72	\$2.72	\$2.72	\$2.72
6+	\$2.88	\$2.88	\$2.88	\$2.88	\$2.88	\$2.88	\$2.88
1+	\$3.20	\$3.20	\$3.20	\$3.20	\$3.20	\$3.20	\$3.20

	2.1mm	2.3mm	2.5mm	2.7mm	2.9mm	3.1mm
12+	\$2.72	\$2.72	\$4.76	\$4.76	\$4.76	\$5.65
6+	\$2.88	\$2.88	\$5.04	\$5.04	\$5.04	\$5.99
1+	\$3.20	\$3.20	\$5.60	\$5.60	\$5.60	\$6.65



BUSCH® CUP BURS, FIG. #77B

Order # 18-10012

Material Tungsten Carbide Steel
 Head Shape Ball
 Shank Size 3/32"
 Sold Each

Kit Order # 20-1040

18-Piece Bur Kit
 (1 each) 0.5mm-4.0mm

12+	6+	1+
\$46.41	\$48.43	\$50.45

	0.5mm	0.6mm	0.7mm	0.8mm	0.9mm	1.0mm	1.2mm
12+	\$8.14	\$8.14	\$8.14	\$8.14	\$8.14	\$8.14	\$8.14
6+	\$8.50	\$8.50	\$8.50	\$8.50	\$8.50	\$8.50	\$8.50
1+	\$8.85	\$8.85	\$8.85	\$8.85	\$8.85	\$8.85	\$8.85

	1.4mm	1.6mm	1.8mm	2.1mm	2.3mm	2.7mm
12+	\$8.14	\$8.14	\$8.14	\$8.14	\$8.14	\$15.59
6+	\$8.50	\$8.50	\$8.50	\$8.50	\$8.50	\$16.27
1+	\$8.85	\$8.85	\$8.85	\$8.85	\$8.85	\$16.95



STULLER SELECT ROUND CARBIDE BURS





PANTHER WAX AND PLASTIC CARVING BURS

Coarse burs that will not clog with wax.



Item	Order #	Grade	Width	12+	6+	1+
A	77-4123	Very Coarse	2.3mm	\$22.49	\$24.39	\$27.10
B	77-4131	Very Coarse	3.1mm	\$30.01	\$31.77	\$35.30
C	77-4151	Very Coarse	5mm	\$37.02	\$39.20	\$43.55



WOLF WAX CYLINDER BUR

D. Made of high-speed steel. Coarse-cut for rapid removal of wax. Teeth on the end for milling. Longer cutting surface. Shorter shank length (25mm) reduces centrifugal wobble.

WOLF WAX ROUND BUR

E. Made of high-speed steel. Coarse cut for rapid removal of wax. Ideal cut for controlled rapid removal of material.



Item	Order #	OD	Shank Size	12+	6+	1+
CYLINDER						
D	20-1200	5-piece set		\$64.57	\$70.02	\$77.80
	20-1205	11.1mm	1/8" Each	\$18.22	\$19.76	\$21.95
ROUND						
E	20-1206	5-piece set		\$58.93	\$61.49	\$64.05
	20-1207	1.7mm	3/32" Each	\$6.14	\$6.66	\$7.40
	20-1208	3.5mm	3/32" Each	\$8.13	\$8.82	\$9.80
	20-1209	5mm	3/32" Each	\$8.96	\$9.72	\$10.80
	20-1210	7.2mm	3/32" Each	\$10.42	\$11.30	\$12.55
	20-1211	8.9mm	3/32" Each	\$12.20	\$13.23	\$14.70



GROBET USA ROTARY FILES

High-speed steel. Cylinder shape fits easily into insides of rings. Not recommended for use exceeding 5,000 RPM.

Order #	Grade	Length	OD	Shank	12+	6+	1+
33-6029	Standard	1 1/2"	1/2"	3/32"	\$26.78	\$28.35	\$31.50
33-6032	Fine	1 1/2"	1/2"	3/32"	\$38.23	\$39.89	\$41.55
33-6350	Standard	1"	1/2"	1/8"	\$26.36	\$27.50	\$28.65
33-6355	Fine	1 1/2"	1/2"	1/8"	\$38.23	\$39.89	\$41.55



INSIDE RING BURS

Made of carbide steel for extra-long life. These cylinder burs are designed for fast deburring, smoothing, and finishing of inside-ring surfaces. Made in the USA.

Item	Order #	Grade	Length	OD	Shank	12+	6+	1+
SINGLE-CUT								
A	20-2924	Medium	5/8"	3/4"	1/8"	\$22.65	\$23.99	\$26.65
DOUBLE-CUT								
B	20-2920	Fine	3/4"	3/8"	1/8"	\$18.19	\$19.26	\$21.40
C	20-2922	Fine	5/8"	1/4"	1/8"	\$16.58	\$17.55	\$19.50
D	20-2930	Fine	1/2"	1/4"	3/32"	\$11.99	\$12.69	\$14.10
E	20-2932	Extra Fine	1/2"	1/4"	3/32"	\$11.99	\$12.69	\$14.10
F	20-2934	Extra Coarse	1/2"	1/4"	3/32"	\$11.99	\$12.69	\$14.10



CARBIDE CYLINDER BURS

Cylinder Length: 1/2" Shank Length: 1"
 Cylinder Diameter: 1/4" Total Length: 1 1/2"

Item	Order #	Grade	12+	6+	1+
G	20-2820	Coarse	\$9.48	\$10.67	\$11.85
H	20-2821	Medium	\$9.48	\$10.67	\$11.85
J	20-2822	Fine	\$9.48	\$10.67	\$11.85
K	20-2823	Extra Coarse	\$9.48	\$10.67	\$11.85



CUTTERS

Stuller is proud to offer the highest quality milling cutters on the market. These high precision cutters are available in the definitive shapes and sizes used by CAD/CAM operators around the world.

Item	Order #	Description	Color	Length	OD	1+
L	39-1830	Pyramid	Light Blue	1 1/2"	.004"	\$106.10
M	39-1831	Helical Pyramid	Dark Blue	1 1/2"	.004"	\$116.70
N	39-1832	Double Flute	Black	1 1/2"	00.4"	\$87.05
P	39-1833	Single Flute	Yellow	1 1/2"	0.47"	\$79.60



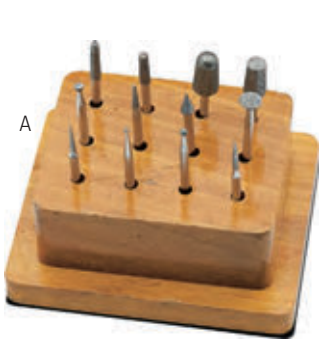

3/32" shank burs measuring 1/4" in length which are electroplated with diamond particles. Excellent for stone carving, clean up work, glass, ceramics and metals.



DIAMOND BURS

These long-wearing, high-quality diamond burs give you the hardness of diamond plate over steel to provide you with the uniform cutting edge you need to shape, grind, and finish with precision on a variety of materials. Round diamond point. Excellent for stone carving, clean-up work, glass, ceramics, and metals.

Item	Order #	Description	Grade	Length (mm)	OD (mm)	12+	6+	1+
A	19-5000	Set of 12				\$45.05	\$47.70	\$53.00
B	19-5002	Inverted Cone	Medium Fine	1.5	2.7	\$3.91	\$4.08	\$4.25
C	19-5006	Tapered Cylinder	Medium Fine	8.0	2.0	\$3.91	\$4.08	\$4.25
D	19-5008	Round Cone	Medium Fine	12.0	7.0	\$12.33	\$13.05	\$14.50
E	19-5009	Cylinder	Medium Fine	4.0	3.0	\$3.91	\$4.08	\$4.25
F	19-5010	Tapered Point	Medium Fine	10.0	1.5	\$3.91	\$4.08	\$4.25
G	19-5014	Point	Medium Fine	10.0	1.5	\$3.91	\$4.08	\$4.25
H	19-5015	Cone	Medium Fine	6.0	3.5	\$4.19	\$4.37	\$4.55
J	19-5017	Cylinder	Medium Fine	10.0	6.0	\$8.46	\$8.96	\$9.95
K	19-5023	Rounded Cylinder	Medium Fine	12.0	3.0	\$3.91	\$4.08	\$4.25
L	19-5027	Round	Coarse		1.0	\$3.91	\$4.08	\$4.25
M	19-5028	Round	Coarse		2.0	\$3.91	\$4.08	\$4.25
N	19-5029	Round	Coarse		3.0	\$4.65	\$4.85	\$5.05
P	19-5030	Round	Coarse		4.0	\$4.65	\$4.85	\$5.05
Q	19-5020	Round	Medium Fine		1.0	\$3.91	\$4.08	\$4.25
R	19-5021	Round	Medium Fine		2.0	\$3.91	\$4.08	\$4.25
S	19-5026	Round	Medium Fine		4.0	\$3.91	\$4.08	\$4.25
T	19-5031	Tapered Cylinder	Medium Fine	4.0	1.5	\$3.91	\$4.08	\$4.25



STULLER SELECT FINE DIAMOND POINTS

Fine grit 1/16" shank.

Item	Order #	Description	Length	OD	12+	6+	1+
U	19-6000	Set of 6			\$39.56	\$41.28	\$43.00
V	19-6001	Needle	8.0mm	1.4mm	\$6.99	\$7.30	\$7.60
W	19-6002	Flame	8.0mm	1.4mm	\$6.99	\$7.30	\$7.60
Y	19-6003	Flame	3.5mm	1.6mm	\$6.99	\$7.30	\$7.60
Z	19-6004	Football	3.0mm	1.6mm	\$6.99	\$7.30	\$7.60
AA	19-6005	Football	5.0mm	2.3mm	\$6.99	\$7.30	\$7.60



DIAMOND COATED BUR KIT

Order #	Description	12+	6+	1+
19-5001	20-Piece Assorted	\$6.52	\$7.07	\$7.85
19-5001	30-Piece Assorted (shown)	\$6.64	\$7.20	\$8.00

DIAMOND DISC CUTTER

Five diamond discs all medium grit and diamond electroplated onto both sides and used for cutting or sanding. Kit includes an $\frac{1}{8}$ " mandrel and discs that will also fit perfectly on a $\frac{3}{32}$ " shank.

Order #	OD	Thickness	12+	6+	1+
11-8235	$1\frac{3}{16}$ "	0.84mm	\$12.60	\$14.18	\$15.75



STULLER SELECT DIAMOND KNIFE BURS

Medium grit $\frac{3}{32}$ " shank.

Item	Order #	Description	OD	12+	6+	1+
A	19-6010	Assortment		\$34.87	\$36.38	\$37.90
B	19-6011	Knife-Edge	2.3mm	\$8.79	\$9.17	\$9.55
C	19-6012	Knife-Edge	5.0mm	\$13.62	\$14.21	\$14.80
D	19-6013	Knife-Edge	6.0mm	\$13.62	\$14.21	\$14.80

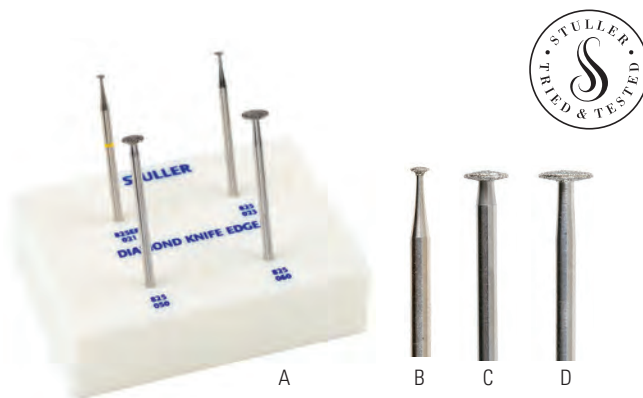

SPECIALTY DIAMOND DISC AND CUT-OFF WHEELS

These specialty discs are designed to cut metals, shanks, prongs, fins, and stones. The discs are impregnated with diamonds – not just plated – so they will last longer. The wheels are set on $\frac{3}{32}$ " shanks. Made in Germany.

Item	Order #	Description	OD	Thickness	12+	6+	1+
E	11-8200	Serrated Disc/Saw	30mm	0.3mm	\$43.48	\$46.04	\$51.15
F	11-8210	Sintered Full Wheel	8mm	0.9mm	\$41.35	\$43.15	\$44.95
G	11-8211	Sintered Full Wheel	22mm	0.4mm	\$59.85	\$62.45	\$65.05
H	11-8212	Sintered Disc	20mm	0.17mm	\$55.84	\$58.27	\$60.70
J	11-8220	Mini-Flex	8mm	0.15mm	\$22.26	\$23.23	\$24.20
K	11-8230	Separating Wheel	22mm	0.15mm	\$23.63	\$25.02	\$27.80

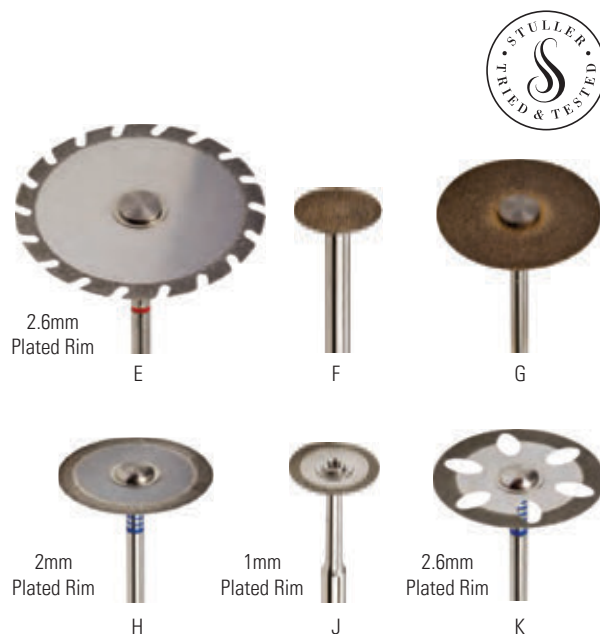

MEDIUM WAX BURS

Swiss-made, tungsten-vanadium steel burs fluted to eliminate wax build-up. Can also be used for wood carving or plastic. Sizes and shapes may vary.

Order #	Description	12+	6+	1+
18-5089	Set of 12, Medium	\$26.10	\$28.31	\$31.45



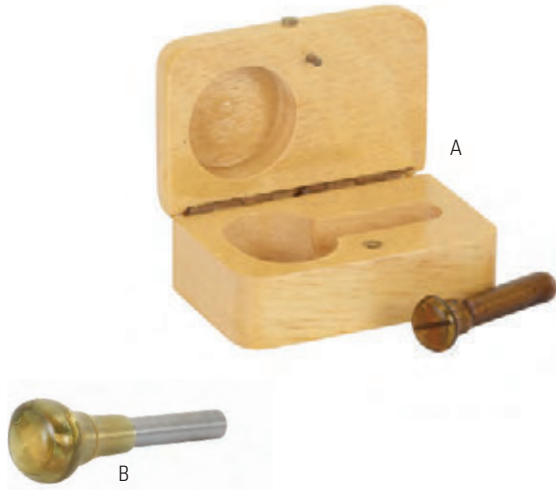

CARBIDE PRACTICE FLY WHEELS

B. Carbide practice flywheels are strongly recommended before using a diamond flywheel.

DIAMOND FLY WHEELS

A. Precision manufactured for bright-cutting gold and other precious metals. Constructed with a high-grade, industrial diamond chip. Note: A diamond flywheel is a delicate, precision instrument. As it is an industry standard, we do not offer a warranty—no refunds or exchanges. Caution: Wear proper eye and face protection.

Item	Order #	Degree	OD	12+	6+	1+
A	11-0900	90°	4.0mm	\$52.72	\$55.01	\$57.30
	11-0901	120°	4.0mm	\$52.72	\$55.01	\$57.30
	11-0902	130°	4.0mm	\$52.72	\$55.01	\$57.30
	11-0903	150°	4.0mm	\$52.72	\$55.01	\$57.30
	11-0904	180°	4.0mm	\$52.72	\$55.01	\$57.30
	11-0906	90°	3.0mm	\$52.72	\$55.01	\$57.30
	11-0907	120°	3.0mm	\$52.72	\$55.01	\$57.30
	11-0908	130°	3.0mm	\$52.72	\$55.01	\$57.30
	11-0909	150°	3.0mm	\$52.72	\$55.01	\$57.30
	11-0910	180°	3.0mm	\$52.72	\$55.01	\$57.30
B	11-0915	90°	3.0mm	\$34.26	\$36.27	\$40.30
	11-0916	90°	4.0mm	\$34.26	\$36.27	\$40.30

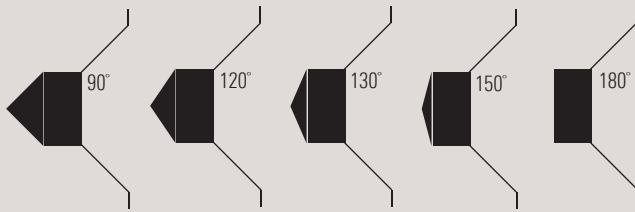

DIAMOND FLY WHEELS

The diamond flywheel requires little or no maintenance when used properly. There are a few considerations that should be identified to maximize the serviceability of the tool's life. First, the diamond flywheel is intended to run at high speeds in excess of 30,000 RPM. The 30,000 RPM is considered the minimum speed at which one of these wheels should be operated.

The most common arrangement for a flex shaft and handpiece combination is the "R" series motor and #35 handpiece with the planetary drive system. Lubricating the diamond flywheel prior to and during cutting is not recommended. When using the diamond flywheel, it is necessary to allow it to come up to full speed before engaging with the surface to be cut. When cutting, very light pressure is all that is required. The wheel only needs to contact the surface to cut. If excessive force is applied while cutting, there is risk of knocking the diamond loose from the flywheel. If this happens, the flywheel is ruined and no attempt should be made to glue the diamond back into the flywheel. Excessive pressure will also reduce the speed of the flywheel during operation, thereby reducing its efficiency as well as making it more susceptible to damage.



FOREDOM® H.35

Precision, high-speed handpiece with unique, planetary drive that produces 2½ times the speed of the motor. This feature makes it the perfect tool for bright cutting with diamond flywheels and for other high-speed work with carbide and diamond points. Seven collets are available ranging from 1/16" to 3/16" including metric sizes. Pre-lubricated, double shielded, ball bearings rated for speeds to 35,000 RPM and comes with 1/8" collet (unless other size is specified). Recommended motor speed is 14,000 RPM.

Item	Order #	Description	12+	6+	1+
C	34-2216	H.35 Handpiece	\$125.38	\$132.75	\$147.50
D	34-2135	3/32" Collet	\$17.21	\$18.23	\$20.25
E	34-2138	1/16" Collet	\$17.21	\$18.23	\$20.25
F	34-2139	3/16" Collet	\$17.21	\$18.23	\$20.25

ROTATING BUR HOLDER

Conveniently stores and organizes all sizes of burs. Holds 69, $\frac{3}{32}$ " or $\frac{1}{8}$ " shank, burs and 45, $\frac{1}{16}$ " shank, burs. Made in the USA.

Item	Order #	W x L	12+	6+	1+
A	19-9272	7" x 4"	\$15.50	\$16.18	\$16.85

BUR ORGANIZER

Lazy Susan type of bur organizer. Holds up to 150, $\frac{3}{32}$ " shank, burs.

Item	Order #	W x L	12+	6+	1+
B	19-9270	7" x 4"	\$12.33	\$13.37	\$14.85

ROTATING TOOL HOLDER

Rotating bur holder organizes 114, $\frac{3}{32}$ " shank, burs. It also features a handy $2\frac{3}{4}$ " width x 3" depth cup at the top for storing bench tools.

Item	Order #	W x L	12+	6+	1+
C	19-9273	7" x 4"	\$15.50	\$16.18	\$16.85

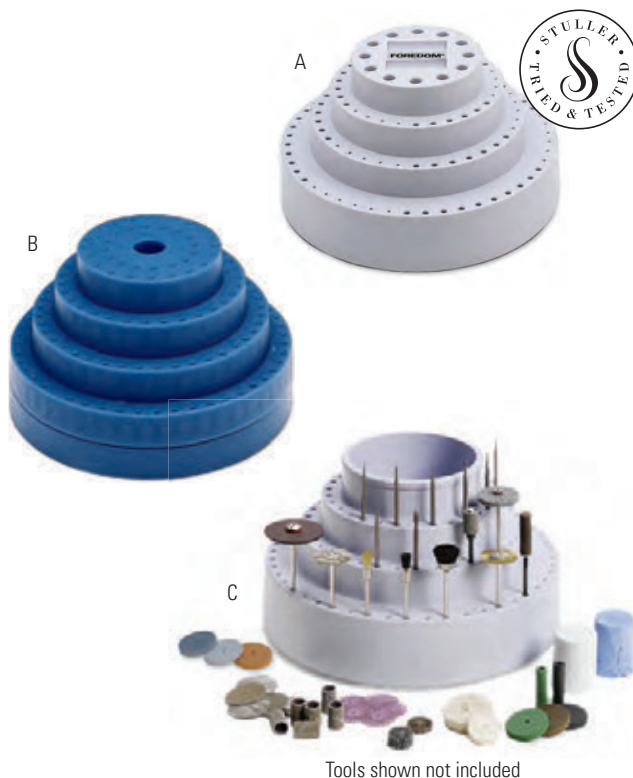
**PLASTIC BUR HOLDER**

Square plastic stand with clear cover for storing 34, $\frac{3}{32}$ " and 18, $\frac{1}{8}$ " shank accessories.

Order #	W x L	12+	6+	1+
19-9252	2 $\frac{1}{2}$ " x 2 $\frac{1}{2}$ "	\$3.91	\$4.08	\$4.25

**PLASTIC BUR STAND**

Holds $\frac{3}{32}$ " shank burs securely in place.

Order #	W x H x D	12+	6+	1+
19-9250	5" x 1" x 3"	\$5.74	\$6.08	\$6.75

**MATT GOLD COLLECTOR**

Traps gold and other precious metals for easy retrieval. Provides convenient precious metal collection while enabling you to keep arms and hands in a natural working position. Protects your eyes and skin from dust and flying particles. Optically clear Plexiglass® shield allows for glare-free viewing. Completely portable, lightweight, and strong. Plexiglass shield easily removes for cleaning and scrap collection.

Order #	W x L x H	12+	6+	1+
21-0960	7" x 7" x 9"	\$85.51	\$90.54	\$100.60





Tools sold separately

A

WOODEN BUR HOLDER

Clean up your bench with this spinning tool holder that makes hand tools easy-to-reach. This lazy Susan—style rack suits your small tool storage needs for gravers, files, burs, punches, and abrasive wheels.

Item	Order #	W × L × H	12+	6+	1+
A	19-9275	8" × 10" × 7"	\$34.40	\$37.31	\$41.45



B

C

D

E

WOOD BUR BOX

Sturdy wooden bur boxes for 3/32" shank burs or other mounted tools. Burs sold separately.

Item	Order #	No. of Compartments	12+	6+	1+
B	18-0504	24	\$6.25	\$6.62	\$7.35

WOOD BUR BOX

Sturdy wooden bur boxes for 3/32" shank burs or other mounted tools. Burs sold separately.

Item	Order #	No. of Compartments	12+	6+	1+
C	18-0505	36	\$6.84	\$7.25	\$8.05

WOOD BUR BOX

Sturdy wooden bur boxes for 3/32" shank burs or other mounted tools. Burs sold separately.

Item	Order #	No. of Compartments	12+	6+	1+
D	18-0506	72	\$9.86	\$10.44	\$11.60

WOOD BUR BOX

Sturdy wooden bur boxes for 3/32" shank burs or other mounted tools. Burs sold separately.

Item	Order #	No. of Compartments	12+	6+	1+
E	18-0507	100	\$10.46	\$11.07	\$12.30

BUR CADDY

The hexagon rotating caddy is 8" high with a removable top. This is a great tool to organize your burs and small tools for easy access. There are 288 holes for burs and tools along with two 3" magnetic strips to keep your files and other hand tools close. The top offers 11mm in diameter holes for extra tool storage. With the rotating caddy every tool it holds is visible and easy to access.

Item	Order #	W x L x H	12+	6+	1+
A	19-9276	6" x 6" x 8"	\$33.82	\$36.67	\$40.75

**HANDY BUR BOX**

Handy box for storing burs at the bench. Makes finding the right size bur easy and convenient. The handy bur box slips into your center bench drawer. Leave the burs in their original plastic packaging for quick retrieval. Made of hardwood with removable dividers.

Item	Order #	W x L x H	12+	6+	1+
B	18-0509	8" x 5 ⁷ / ₈ " x 1 ¹ / ₂ "	\$7.82	\$8.16	\$8.50

**HANDY BUR BLOCK**

Cured, hardwood block with 88 holes that are 1/8" in diameter to accommodate either 1/8" or 3/32" shanks. Block is slanted and also features stay-put rubber pads on the bottom to prevent sliding. Will hold burs, needle files, beaders, and mini brushes.

Item	Order #	W x L	12+	6+	1+
C	19-9260	4 ¹ / ₂ " x 6"	\$11.68	\$12.19	\$12.70

**BUR STAND PLUS**

This bur stand is solid smooth wood painted black for an easy to see tool holder. This stand has a magnetic side for easy grab and go. There are 88 holes (8 holes of 11 drilled 4mm holes). There is also a long groove for holding your unmounted wheels and other tools. This stand also has felt cushions on the bottom of the stand to prevent scratching on your bench.

Item	Order #	W x L x H	12+	6+	1+
D	19-9277	5 ¹ / ₄ " x 6 ¹ / ₂ " x 2"	\$18.59	\$20.16	\$22.40

**BUR STAND**

This bur stand fits on any microscope or any rod that has a diameter of 1¹/₂". This stand can stay on your bench or be mounted on a shaft or rod. This stand has a detachable base that holds nine 3/32" burs. The cylinder is split and connected by a single hex screw (hex key supplied) that can be tightened to fit on the shaft of a microscope stand. The cylinder has 48 holes.

Item	Order #	W x L x H	12+	6+	1+
E	19-9280	3 ³ / ₄ " x 3 ¹ / ₂ " x 3 ¹ / ₄ "	\$32.05	\$33.93	\$37.70



Perfactory[®] Micro 3D Printer with Curing Chamber

The Perfactory 3D printer from EnvisionTEC is the smallest professional-grade desktop 3D printer in size with the highest resolution. It is a low cost, easy maintenance, and user friendly desktop manufacturing system designed for producing high quality models for direct casting or molding. Using the state-of-the-art digital light projection (DLP) technology from Texas Instruments[®] coupled with LED performance, the Perfactory Micro System allows access to a top quality professional grade prototyping system. Utilizing a built-in USB connection, the Perfactory Micro can connect directly to your personal PC workstation and works just like a personal desktop printer.

- Electrical Requirements:
100-120V, 3 Amps / 220-240V, 2 Amps
- Dimensions: 8" W × 9" L × 24" H
- Easy handling through pre-adjusted material modules
- Very few moving parts and minimal consumable components guarantee a strong and reliable system
- Any STL data format can be easily imported using the Perfactory[®] Micro Software Suite
- Fully automated self-calibrating system



Order #	Description	1+
24-1006	Perfactory Micro Hi-Res	\$21,995.00

MACHINE PROPERTIES*	PERFACTORY [®] MICRO HIRES
Build Envelope	1.58" × 1.18" × 3.94" (40 × 30 × 100 mm)
Resolution in X and Y	0.0012" (31 μm)
Dynamic Voxel Resolution in Z (material dependent)**	0.0010" to 0.0014" (25 μm to 35 μm)
Light Source	LED
Data Handling	STL

* Specifications are subject to change without notice. ** A voxel is a volumetric pixel.

MATERIALS AVAILABLE	IDEAL USAGE
PIC 100 M	Direct Casting
EC500 M	Direct Casting
HTM140 M	HTV Molding with minimal post finishing
ABS Tough M	High impact general purpose material
EPIC M	Direct Casting

Perfactory® Micro Advantage 3D Printer

The Perfactory Micro Advantage is a low cost, easy maintenance and user friendly professional desktop 3D printer for the jewelry market. The Micro Advantage provides an attractive entry-level solution for jewelry designers and retailers. It boasts a build envelope that is double that of competitive entries in the market, while maintaining an enhanced XY resolution of 50 microns and a Z resolution that is adjustable from 25 to 100 microns depending on the material used. This size makes the Micro Advantage the perfect companion to the original Micro for jewelry, allowing for larger pieces such as bangles and belt buckles to widen design capabilities. Impressive build speeds of up to 10mm per hour for the full envelope are also possible depending on the material used.

- Office friendly desktop 3D printer
- Plug and play 3D printer with easy to use software interface
- Very few moving parts guarantees a strong and reliable production system
- Fully automated self-calibrating system
- Starter kit includes software CD and ½ KG of material
- Electrical Requirements: 100-120V, 3 Amps/220-240V, 2 Amps
- Dimensions: 10" W × 11" L × 24" H



MACHINE PROPERTIES*	PERFACTORY® MICRO ADVANTAGE
Build Envelope	2.36" × 1.77" × 3.94" (60 × 45 × 100 mm)
Enhanced XY Resolution	0.002" (50 µm)
Dynamic Z Resolution**	0.001" to 0.004" (25 µm to 100 µm)
Build Speed	Up to 0.394" (10 mm)/hour for full envelope**
Light Source	LED
Data Handling	STL

* Specifications are subject to change without notice. ** Material dependent.

MATERIALS AVAILABLE	IDEAL USAGE
PIC 100 M	Casting
EC500 M	Casting
HTM140 M	High temperature molding
EPIC M	Casting

Order #	Description	1+
24-1008	Perfactory Micro Advantage	\$16,500.00



RADIDPOL SET FOR POLISHING

The Hatho RapidPol set comes with everything you need to polish grow lines that are created during the rapid prototype process on resins. Doing this will help you to achieve a better casting.

Order #	Description	1+
11-7102	Rapidpol Set for Polishing	\$81.55

EasyCast 12

The EasyCast 12 is an induction casting machine designed to increase your productivity with a high degree of control. It casts all metals, precious and non-precious, with an automatic frequency setting so you can enjoy a fast melting process. The heating generator utilizes the latest high efficient technology. This reliable modular system has low maintenance requirements and low energy consumption.

FEATURES:

- Advanced digital control panel with status and diagnostics messages
- Centrifugal injection casting with pneumatic movement for fast coil decent
- Integral water cooling system with pressure and water temperature control
- Centrifugal arm balancing with adjustable counterweight
- Infrared temperature reader with automatic or manual working cycle
- Auto locking of the chamber lid during centrifugal phase for maximum safety
- Melting power regulation
- DC motor with reduction gear: adjustable acceleration from 0.1 to 1 second
- Max rotating speed-500 turns/minute rotation timeout pre-set at 40 seconds
- Normal atmospheric operation
- Internal vacuum pump (EC-12)
- Insert (Argon) gas circuit included (EC-12)
- Set up with 44mm diameter crucibles for jewelry casting (EC-12)



BENEFITS:

- Improved energy efficiency
- Higher degree of control
- Increased repeatability
- Low maintenance requirements
- Increased productivity



Absorbed Power kW (max)	3.0
AC Line Volts (50/60Hz)	230±10%
Line Phases	1
Crucible Capacity	150g Pt, 150g Au, 80g Ag
Flask Size (max)	3" × 3"
Max Melting (T°)	2000 C°
IR Temperature Reader	Included
Cooling System	Water-Internal
Vacuum Pump	Included
Weight	265 lbs (120 kg)
Dimensions W × L × H	19.2" × 26" × 41" (49 × 66 × 105 cm)

Order #	Description	W × L × H	1+
22-2160	EasyCast12	19" × 26" × 41"	\$16,650.00

CS1 Digital Control Casting Machine

The CS1 Digital Control Casting Machine is the next step for casting made easy. This casting machine has a overhaul of new features to give you the ultimate casting experience.

FEATURES:

- New melting circuit
- New control board
- New temperature reader
- New Hi-Tech Thermo-Regulator
- Metal emissivity regulation
- Auto-diagnosis
- 10 memories
- Vacuum-Argon washing cycle
- Automatic vacuum release

BENEFITS:

- Better power regulation
- Totally microprocessor controlled
- More accurate temperature reading
- Better heating cycle control
- Easier to find the metal melting point
- 10 error messages
- 9 parameter per program
- For casting with stone
- No more valve on the top of the lid

This system was designed primarily for the casting of platinum, but can also be used for casting all precious metal alloys and industrial alloys. The CS1 is available with a 7.5kW melting circuit and can be fitted with temperature controls, vacuum systems, and inert gas inlets. The crucible can handle about 350 grams of platinum, 800 grams of pure gold or 250 grams of stainless steel.



Absorbed Power kW (max)	7.5
Medium Frequency	
Melting Circuit	30-60 Khz
Crucible Capacity	350g Pt
Flask Size (max)	4" x 4.75"
Power Supply	220/230 V Three Phase - 380 V Three Phase
Vacuum Pump	Included
Weight	380 lbs (172 kg)
Dimensions W x L x H	30" x 25" x 40" (76 x 167 x 102 cm)

Order #	Description	W x L x H	1+
22-2200	CS1 Digital Casting Machine	30" x 25" x 40"	\$36,950.00

SuperCast 12

SuperCast 12 is a casting system in a class by itself, with development of the patented RCS (Rotating Coil System), the user no longer has to raise or lower the induction coil. With the RCS, the induction coil is integrated into the centrifugal arm, thus allowing the material being cast to continue stay under heat as it is being shot into the flask. Being able to keep the metal under heat during the centrifuge process leads to denser castings with less porosity. The Supercast is totally microprocessor controlled. With decreased coil maintenance you can spend more time focusing on the actual casting of items.

FEATURES:

- Patented RCS system (Rotating Coil System)
- Totally microprocessor controlled
- 10 memories (complete working programs with up to 9 parameters/program)
- 4kW induction melting circuit

- Fiber optic temperature control with ETC calibration
- 220V, single-phase power requirement
- Excellent for gold alloy
- Ideal for chrome-cobalt and nickel-chrome
- Exceptional for platinum and titanium
- Vacuum pump system
- Inert gas dispensing system
- Internal water circulator

BENEFITS:

- Decreased coil maintenance
- Eliminates induction coil movement
- Metal is still heated during rotation
- Extremely compact metal casting



Power	4 kW
Frequency	65/90 kHz
Consumption	AC 220V, Single phase, 50/60 Hz
Crucible Capacity	200g Pt
Flask Size (max)	3" x 3"
Max Melting (T°)	2000 C°
Temperature Reader	Optional
Cooling System	Built-in or external closed circuit system
Vacuum Pump	Included
Rotation Time	Preset at 45 seconds, automatic rotation stop
Casting Time	Adjustable
Weight	256 lbs (130kg)
Dimensions W x L x H	27" x 22" x 40" (67 x 22 x 100 cm)

Order #	Description	1+
22-2190	SuperCast 12	\$29,500.00

EasyMelt and EasyMelt HT

The EasyMelt is a robust industrial design for low or high volume melting and is micro-processor controlled. This is a compact bench-top system for your everyday use. For your convenience it has fast melting times with a powerful 2.5kW melting circuit.

FEATURES:

- Robust industrial design for low or high volume melting
- Powerful 2.5 kW melting circuit for fast melt times
- Micro-processor controlled
- Operates on 220V, 1-phase; 50/60 Hz
- Thermocouple temperature control
- 10-15 minute melt times for up to 2 kg of gold (EasyMelt)
- Under 5 minute melt time for up to 250 grams of platinum (EasyMelt HT)
- Optional water cooling system

BENEFITS:

- Compact bench-top system
- Extremely fast and efficient melting of small metal quantities
- Economical and practical for jewelry applications
- Greater degree of control over melting processes



Order #	Description	1+
22-2180	EasyMelt	\$5,450.00
22-2170	EasyMelt HT	\$5,950.00

LED display for power regulation, exact timing, and precise temperature control.



EasyMelt Specifications:

Power Supply	220V, 1-Phase; 50/60 Hz
Output Power	2.5 kW
Crucible Capacity	2 kg gold (18kt weight) 1.2 kg silver
Water Cooling	System requires water cooling
Weight	20 lbs (9kg)
Dimensions W x L x H	14" x 18" x 7" (355 x 457 x 178 mm)

EasyMelt HT Specifications:

Power Supply	220V, 1-Phase; 50/60 Hz
Output Power	2.5 kW
Crucible Capacity	250 grams platinum 150 grams gold
Water Cooling	System requires water cooling
Weight	20 lbs (9kg)
Dimensions W x L x H	14" x 18" x 7" (355 x 457 x 178 mm)



Centrifugal Casting Machine 20" W x 20" L x 12" H

NEYCRAFT SPINCASTER

This Neycraft Spincaster comes with a self-contained well and is mounted on a base. The unit comes with one silica crucible with a capacity of 9 oz. gold and 5 oz. silver. The unit has an easy balancing system with lock. Ships UPS. Also comes with:

- 3" x 3" stainless steel, solid-wall flask with 3" base
- 2" x 2½" solid flask with a base
- One pair of tongs
- Universal cradle for the flask

Item	Order #	Description	12+	6+	1+
A	22-3600	Centrifugal Casting Machine	—	—	\$750.00
B	22-3604	Complete Slide Assembly	—	—	\$241.45
C	22-3602	Replacement Spring	\$80.37	\$85.10	\$94.55
D	22-3603	Counter Balance Weight	\$34.38	\$36.41	\$40.45
E	22-4620	Replacement Crucible	\$20.65	\$21.55	\$22.45

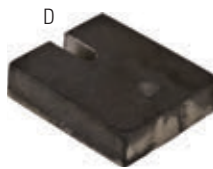
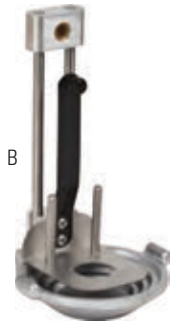

CENTRIFUGAL FLOOR MODEL CASTING MACHINE

The unit that pioneered the centrifugal casting technology in the jewelry industry. "Broken" arm designs allows maximum metal flow into flask.

- Automatic digital count down timer
- Adjustable speed
- ½Hp motor
- Dimensions: 30" W x 30" D x 39" H
- 110V - "Broken" arm designs allows maximum metal flow into flask

Item	Order #	Description	1+
F	22-1304	Centrifugal Machine	\$6,343.15

VACUUM INVESTMENT MACHINE

This 20" x 20" spring-mounted investment table is simple to set up and operate. Its heavy-duty 12-gauge cabinet features a durable powder-coated finish and hinged front panel with latched access to vacuum pump.

- Bell jar dimensions: 14¾ inner diameter 13¼ inner height
- 15CFM/ 1hp Oil-Filled vacuum pump
- Ball vise controlled vacuum flow rate
- Extra thick internal rubber hosing
- Made in the USA

Item	Order #	Description	1+
A	22-1301	Investment Machine	\$7,692.35



COMBINATION CASTING AND VACUUM INVESTING MACHINE

Space saving design incorporates both casting and investing in one unit!

- Heavy duty design and fabrication with the strongest vacuum pump in the market
- Vacuum storage tank enables instantaneous pull around casting flask
- Foot pedal operated for hands free use
- Large flask capacity: up to: 6" diameter and 9" height
- 20" x 20" Investment table
- Counter balanced lift allows easy storage of bell jar
- Dimensions: 42" W x 22" D x 44" H

Item	Order #	Description	1+
B	22-1302	Combination Machine	\$16,153.85



SUPER VAC VACUUM CASTING MACHINE

Proven technology with proven results makes the Arbe Super Vac the choice for the professional caster.

- Heavy duty design and fabrication with the strongest vacuum pump in the market
- Vacuum storage tank enables instantaneous pull around casting flask
- Foot pedal operated for hands free use
- Large flask capacity: up to 8" diameter and 12" height
- Dimensions: 25" W x 25" D x 40" H

Item	Order #	Description	1+
C	22-1300	Casting Machine	\$10,769.25





VAC-U-CAST JUNIOR

Compact, quality-built table-top unit allows for vacuum investing and casting to be accomplished on the same table simply by changing rubber pads and operating two valves. Complete with 9" diameter x 8" high bell jar, crucible with handle, silicon casting pad, and 32 oz. vacuum pump oil. One-year limited manufacturer's warranty. Made in the USA. Replacement parts below.

Order #	Description	1+
22-1180	Vac-U-Cast Junior	\$830.00



STULLER VAC-U-CAST MASTER-CAST

The Vac-U-Cast Master-Cast is an exceptional unit combining all the features with the added dimension of casting in a recessed vacuum chamber. Vacuum investing is accomplished under a bell jar 9" diameter x 8" high. The recessed vacuum chamber will accommodate perforated flasks as large as 5" diameter x 7" high or as small as 3 3/8" diameter x 4" high. A direct drive, two-stage pump and motor create a free air displacement of 85 liters per minute (3cfm) producing a vacuum of 25 microns or better, exceeding the required 29.9 inches of mercury, in less than 1 minute. Motor 1/3hp 120V. (7amp). One-year limited manufacturer's warranty. Made in the USA. Replacement parts below.

Order #	Description	1+
22-1150	Vac-U-Cast Master-Cast	\$1,435.00

REPLACEMENT PARTS

Item	Order #	Description	Size	1+
A	22-1185	Bell Jar (2.8 lb)	9" x 8"	\$115.55
B	21-7005	Perforated Flask (1.39 lb)	3 3/8" x 4"	\$29.25
C	22-4727	Sprue Base (4.35 lb)	3 3/8"	\$4.55
D	21-4999	Adapt Plate Vacuum Hole (1 lb)		\$69.00
E	21-5001	Casting Silicone Seal	7"	\$15.95
F	21-5002	Investing Rubber Pad (Black) (1.5 lb)		\$16.15
	21-5006	Flask Seal (4.8 oz)	2 1/2"	\$15.95
G	21-5003	Flask Seal (4.8 oz)	3 3/8"	\$13.25
H	21-5004	Flask Seal (4.8 oz)	4 1/2"	\$12.20
J	21-5005	Flask Seal (4.8 oz)	5"	\$12.10
K	22-1152	Plate Adaptor (1.51 lb)	3 3/8"	\$69.00
L	22-1153	Plate Adaptor (1.04 lb)	4"	\$73.70
M	21-5000	Silicone Rubber Pad	5 1/2"	\$12.05
N	22-7911	Crucible		\$14.25
P	22-7912	Handle		\$7.05
Q	22-7910	Crucible with Handle		\$22.45

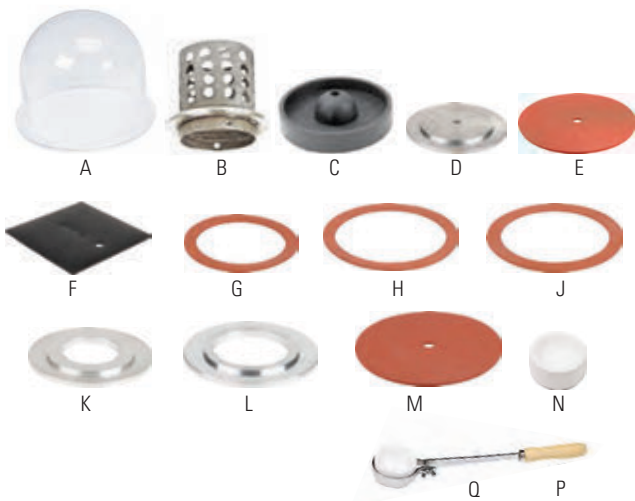

ALUMINIUM CASTING BLOCK

Item	Order #	Description	W x L x H	ID	1+
R	21-4995	Casting Block	6" x 6" x 6"	2 1/2"	\$169.00

REPLACEMENT PARTS

S	21-4996	Aluminum Plate		3 1/2"	\$65.00
	21-4996	Aluminum Plate		4"	\$65.00
	21-4996	Aluminum Plate		3"	\$65.00
T	21-5007	Silicone Gasket			\$16.95

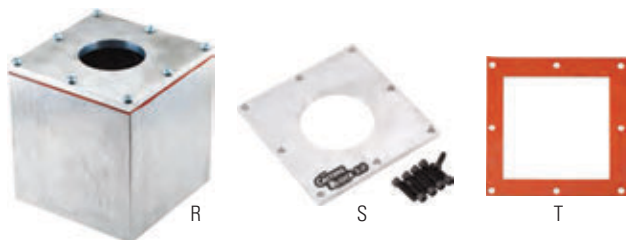

OIL-LESS VACUUM PUMP AND MOTOR

Direct-drive, two-stage, high vacuum pump features a free air displacement of 85 liters per minute (3 cfm) to produce a vacuum of 25 microns or better.

- Powerful 1/3 hp – 1725 RPM – 120V (60 Hz) motor
- Intake nipple OD 1/4"
- A replacement for most vacuum casting or investing machines using 9" x 8" bell jars requiring a high vacuum of 29.9" of mercury
- One-year warranty
- Made in the USA



Order #	Description	1+
22-1170	Oil-Less Vacuum Pump and Motor	\$514.95



VACUUM PUMP

Two stage deep draw vacuum pump, 1/2 hp/ 110v, 3CFM



Order #	Description	1+
22-1200	3CFM Vacuum Pump	\$476.95



VACUUM PUMP

Two stage deep draw vacuum pump, 3/4 hp/ 110v, 8CFM



Order #	Description	1+
22-1201	8 CFM Vacuum Pump	\$630.80



GRIFFITH VACUUM PUMP OIL

A specially-formulated oil used for casting machines and vacuum pumps.

Item	Order #	Description	Capacity	12+	6+	1+
A	54-9000	Pump Oil Bottle	16 oz	\$9.29	\$9.70	\$10.10
B	54-9002	Pump Oil Bottle	32 oz	\$12.79	\$13.34	\$13.90

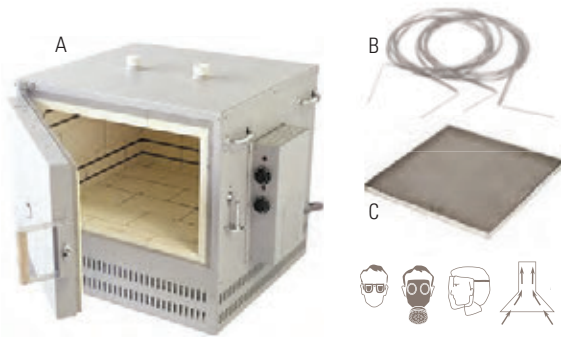

Casting

**JUMBO FIREBRICK FURNACE**

Extra-large capacity firebrick furnace with a chamber measuring ID 22" x 22" x 13". Heavy-gauge steel shell, deeply recessed heating elements, and a swing door allows easy access to the rear of the chamber. Back of the furnace is predrilled to accommodate optional pyrometer or controller thermocouple. Comes with wax elimination tray. Made in the USA. - Maximum temperature: 2,000°F/1,093°C
 - Electrical requirements: 240V - 24 amps - 50/60 hz - 5,760 watts
 - Options: Furnace controller 22-1112 or Pyrometer 22-1600



Item	Order #	Description	W x L x H	1+
A	22-1070	Jumbo Furnace 240V	30½" x 27" x 23"	\$1,599.95

REPLACEMENT PARTS

B	22-1071	Heating Element (Pack of 2)		\$84.75
C	22-1072	Wax Elimination Tray (included)	20" x 20"	\$62.50

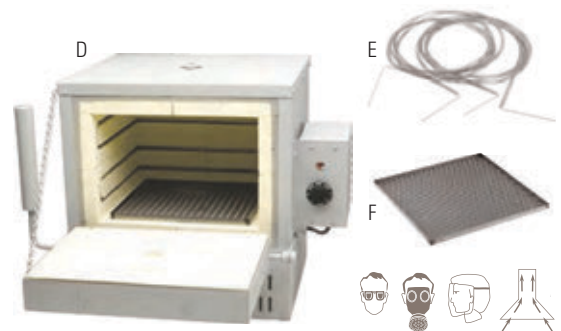
**LARGE FIREBRICK FURNACE**

Large capacity firebrick furnace, chamber dimensions ID 13" x 13½" x 8¾". Heavy-gauge steel shell, deeply recessed heating elements, counter-weighted door, 10-setting switch, and a top vent. Back of the furnace is predrilled to accommodate optional pyrometer or controller thermocouple. Comes with wax elimination tray. Made in the USA.
 - Maximum temperature: 2,000°F/1,093°C
 - Electrical requirements: 240V - 13amps - 50/60hz
 - Options: Furnace controller 22-1112 or Pyrometer 22-1600



Item	Order #	Description	W x L x H	1+
D	22-1060	Large Furnace 240V	21½" x 19" x 18"	\$946.95

REPLACEMENT PARTS

E	22-1061	Heating Element (Set of 2)		\$105.80
F	22-1062	Wax Elimination Tray (included)	11½" x 11½"	\$20.70

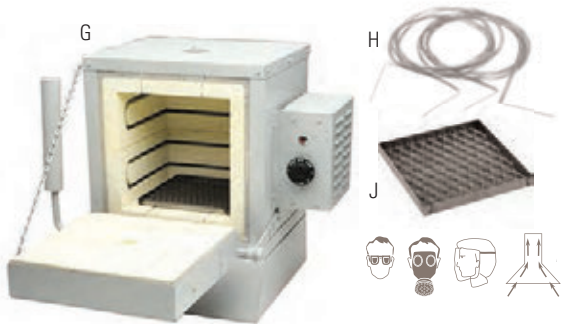
**MEDIUM FIREBRICK FURNACE**

Medium-size, firebrick furnace with a chamber measuring ID 8½" x 9" x 8¾". Heavy-gauge steel shell, deeply recessed heating elements, counter-weighted door, 10-setting switch, and a top vent. Back of furnace is predrilled to accommodate optional pyrometer or controller thermocouple. Comes with wax elimination tray. Made in the USA.
 - Maximum temperature: 2,000°F/1,093°C
 - Electrical requirements: 120V - 50/60hz - 14.1amps
 - Options: Furnace Controller 22-1100, Pyrometer 22-1600

Item	Description	W x L x H	1+
G	Medium Furnace 120V	17½" x 15" x 18"	\$844.15

REPLACEMENT PARTS

H	22-1056	Heating Element (Set of 2)	\$84.75	
J	22-1057	Wax Elimination Tray (included)	7" x 7"	\$39.00

**SMALL FIREBRICK FURNACE, 120V**

Small capacity firebrick furnace with a heavy-gauge steel shell, deeply recessed heating elements, and a swing door with inspection port. Comes with a wax elimination tray.
 - Maximum temperature: 2,000°F/1,093°C
 - Electrical Requirements: 120V - 14 amps - 50/60 hz
 - Chamber Measures: 6" W x 6" H x 6" D
 - Optional: Furnace Controller 22-1100 or 22-1600 Pyrometer

Item	Order #	Description	W x L x H	1+
K	22-1051	Small Furnace 120V	6" x 6" x 6"	\$589.95

REPLACEMENT PARTS

L	22-1052	Heating Element Set of 2		\$74.15
M	22-1053	Wax Elimination Tray (included)	5" x 5"	\$12.10

FIBER FURNACE WITH CONTROLLER

This small capacity (ID 7 $\frac{3}{4}$ " W x 7 $\frac{3}{4}$ " H x 8" D) chamber is an easy-to-use muffle kiln with a top vent for burnout. Fully programmable it features the "Sentry Xpress 3 Button Digital Controller" with custom burnout program capability as well as built-in 5, 8, and 12 hour preset programs.

- Maximum temperature: 2,000°F/1,093°C
- Electrical Requirements: 120V/15A



Item	Order #	Description	1+
A	22-1005	Fiber Furnace with Controller	\$884.95



A
UL approved

Outside Dimensions:
16.25" W x 19" H x 21.5" D

FIBER FURNACE WITH CONTROLLER

This larger capacity (ID 10 $\frac{1}{2}$ " W x 7" H x 10 $\frac{1}{2}$ " D) chamber is a user-friendly muffle kiln with a top vent for burnout. Fully programmable it features the "Sentry 2.0, 12 Button Controller" with three standard built-in programs, custom program capability, delay start, alarm, skip segment, and more.

- Maximum temperature: 2,000°F/1,093°C
- Electrical Requirements: 120V/15A



Item	Order #	Description	1+
B	22-1008	Fiber Furnace with Controller	\$1,595.00

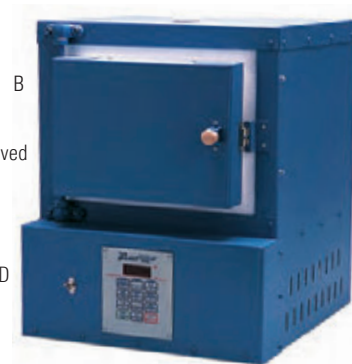

B
Not UL approved

Outside Dimensions:
17.3" W x 21.5" H x 20" D

NEYCRAFT® FIBER FURNACE

Compact, electric furnace features alumina-silica fiber insulation with embedded heating elements. Lighter, faster heating than a firebrick furnace. Made of 20 gauge steel. Cabinet remains cool. Unit comes with pyrometer.

- Maximum temperature: 2,000°F
- Chamber measures: 9" W x 9" H x 6 $\frac{1}{2}$ " D
- Ceramic wax elimination tray: 8" x 8"
- Electrical requirements: 120V, 12 amps, 50/00hz, 1400 watts

Item	Order #	Description	1+
C	22-1000	Fiber Furnace	\$1,038.50
D	22-1123	Fiber Hardening Agent	\$9.35
E	22-1124	Replacement Muffle 120V	\$341.30
F	22-1101	Infinity Controller	\$72.45
G	22-1102	Knob Infinite Control	\$14.45



C
Outside Dimensions:
15" W x 14.3" H x 14.13" D

VULCAN BENCHTOP FURNACES

The Vulcan, programmable air exchange furnaces offers faster, cleaner burnout than traditional furnaces. Pre-heated air is drawn through the chamber and removed with an internal Venturi Exhaust System. The removal of all ash and other contaminants make this furnace ideal for platinum burnout. Programmable temperature ranging from 122-2012°F assures precision firing. Nine three-stage programs, icon graphics for easy data entry, and advanced hybrid muffle design make this furnace a requirement for any product casting operation. Two-year manufacturer's warranty.

- Max Temperature: 2,012°F (1,100°C)
- Exterior Dimensions: 15.8" W x 16" H x 17" D
- Interior Dimensions: 9" W x 7" H x 9" D
- Flask Capacity: Solid, 15 - 2" x 3", 4 - 4" x 6";
Perforated, 2 - 4" x 6" - Power: 240V/7.2 amps/2200 watts











Item	Order #	Description	1+
H	22-1045	Vulcan 3550A Furnace with Air Exchange, 230V	\$2,595.00
J	22-1047	Replacement Muffle 240V	\$635.90



H
Outside Dimensions:
15" W x 16" H x 17" D



CONNECTORS/RECEPTACLE CONFIGURATIONS		15 Ampere		20 Ampere		30 Ampere	
		Rececle	Plug	Receptacle	Plug	Receptacle	Plug
2P3w Grounding	125V	 A. 22-1100	 22-1100	 B. 22-1110	 22-1110		
2P3w Grounding	240V					 22-1112	 22-1112
3P3w Grounding	125V/250V					 Special order plugs for older models	 Special order plugs for older models



STULLER FURNACE CONTROLLER

Programmable controller for burnout furnaces with three pre-programmed cycles and six easily custom programmed to the individual casters needs. Easy "start up", choice of a 5-hour, 8-hour or 12-hour cycle by touch entry key. Step-by-step instructions for creating a custom burnout cycle are easy to follow. Added features: power failure protection, delay start time from 1 minute to 99 hours (great for overnight burnouts), a reminder signal to remove wax trays, and digital temperature readout. Self-standing or can be easily mounted to a wall. Comes with thermocouple. Dimensions: 16" x 4" x 7".

Item	Order #	Description	Volts	Amps	Hertz	1+
A	22-1100	Controller	120	15	60	\$695.95
B	22-1110	Controller	120	20	60	\$695.95
	22-1112	Controller	240	30	50/60	\$729.00
C	22-1113	Replacement Thermocouple				\$61.40

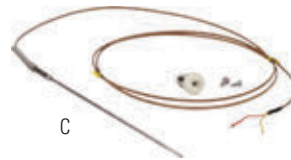

PYROMETER

Used to measure temperature in burnout ovens. Measures within 98% accuracy, from 0° to 2,500°F on meter. Has 5" lead and sheathed 1/8" thermocouple.

Order #	Description	1+
22-1600	Analog (Needle) Pyrometer	\$164.20

STRESS-RELIEVED, QUARTZ STIRRING ROD

Used to stir molten metal. Made of superior quality clear quartz, annealed and fire polished. Melting point 3,183°F (1,750.6°C).

Item	Order #	Outside Diameter	Length	12+	6+	1+
A	21-9050	3/8"	12"	\$18.31	\$19.10	\$19.90

CARBON STIRRING RODS

Used to stir gold while melting in crucibles.

Item	Order #	Outside Diameter	Length	12+	6+	1+
B	22-9001	1/4"	9"	\$4.14	\$4.32	\$4.50
	22-9002	1/2"	12"	\$7.22	\$7.54	\$7.85

KERR® AUTO STANDARD ELECTRO-MELT™

Digitally controlled, the Kerr® standard Electro-Melt™ is recommended when sustained high temperature use is required. Electronic controller regulates the temperature by providing full power input until a pre-selected temperature is attained.

- 1,800°F/982°C in 22 minutes (empty crucible)
- Maximum temperature 2,012°F/1,100°C
- Melting Capacity: Gold 930g/30oz; Silver 775g/25oz
- CE, CSA Certified



Item	Order #	Description	Volts	Capacity	1+
C	22-1029	Auto Standard Electro-Melt	120V		\$1,155.95

REPLACEMENT PARTS

D	22-1028	Graphite Crucible (6.32oz)		30 oz	\$40.25
E	15-0526	Heating Element			\$351.95

KERR® AUTO MAXI ELECTRO-MELT™

The Kerr® Maxi Electro-Melt™ has a melting capacity of up to 100 oz of gold or 83 oz of silver. Digitally controlled, the electronic controller regulates the temperature by providing full power input until the pre-set temperature is reached.

- 1,800°F/982°C in 31 minutes (empty crucible)
- Maximum temperature 2,012°F/1,100°C
- Melting Capacity: Gold 3.1 kg/100 oz; Silver 2.6 kg/83 oz
- CE, CSE Certified



Item	Order #	Description	Volts	Capacity	1+
F	22-1035	Auto Maxi Electro-Melt	120V		\$1,535.00

REPLACEMENT PARTS

G	22-1038	Graphite Crucible (1.69oz)		100 oz	\$65.00
---	----------------	----------------------------	--	--------	---------

GROBET USA® DIGITAL METAL MELT

Specially designed and constructed for melting metals for casting and alloying. Features 2,050°F/1,120°C operating range. Has heavy-duty graphite crucible, precise temperature control, LED on/off indicator light, 1 kg (32 oz) capacity, easy-to-read digital display, and 110V-50/60 cycle power.



Item	Order #	Description	1+
H	22-2110	Digital Metal Melt	\$861.00

REPLACEMENT PARTS

J	22-2111	Crucible (11.37 oz)	\$28.60
K	22-2112	Heating Element (5 lb)	\$360.00



Find added video content on Stuller.com.



Casting



A



B



C



D



E



F



G

FILE-A-WAX ORANGE MILLING WAX

This revolutionary wax (burnt orange) was developed for wax milling. The milling wax is available in round, flat tablets, solid bars, and multiple ring tube sizes. The wax is harder than the green standard wax. Great for all CAD milling machines or hand wax carving. Melt point 232°F.

FLIP FIXTURE DISCS

Item	Order #	OD	Height	Per Pack	12+	6+	1+
A	21-9101	2"	0.42"	27 discs	\$28.89	\$30.14	\$31.40
B	21-9102	2"	0.63"	18 discs	\$28.89	\$30.14	\$31.40
C	21-9103	2"	0.83"	15 discs	\$28.89	\$30.14	\$31.40
D	21-9104	2"	1"	12 discs	\$28.89	\$30.14	\$31.40

REVO WAX SLICES

Item	Order #	W x L x H	Per Pack	12+	6+	1+
E	21-9120	2 $\frac{3}{8}$ " x 2 $\frac{3}{8}$ " x 0.32"	8 slices	\$12.24	\$12.96	\$14.40
F	21-9121	2 $\frac{3}{8}$ " x 2 $\frac{3}{8}$ " x 0.47"	6 slices	\$12.24	\$12.96	\$14.40
G	21-9122	2 $\frac{3}{8}$ " x 2 $\frac{3}{8}$ " x 0.7"	4 slices	\$12.24	\$12.96	\$14.40

**MILLING WAX SLICES**

Order #	W x L x H	Per Pack	12+	6+	1+
21-9099	2" x 2" x 0.2"	16 slices	\$12.24	\$12.96	\$14.40



½ lb Kit Contains:
 2– 4" x 2" x .23" slices
 2– 4" x 2" x .42" slices
 1– 4" x 2" x .72" slice

1 lb Kit Contains
 2– 4" x 2" x .23" tablets
 2– 4" x 2" x .32" tablets
 2– 4" x 2" x .42" tablets
 2– 4" x 2" x .49" tablets
 1– 4" x 2" x .72" tablet

HALF LB TABLETS

Order #	W x L x H	Per Pack	12+	6+	1+
21-9114	2" x 4" x .42"	4 slices	\$11.22	\$11.88	\$13.20
21-9115	2" x 4" x .49"	3 slices	\$11.22	\$11.88	\$13.20
21-9116	2" x 4" x 0.72"	2 slices	\$11.22	\$11.88	\$13.20
21-9117	½ lb kit	5 slices	\$12.24	\$12.96	\$14.40
21-9118	1 lb kit	9 slices	\$21.60	\$24.30	\$27.00

WHICH FILE-A-WAX FORMULA IS RIGHT FOR YOUR NEXT PATTERN?

	Blue	Purple	Green	Gold	Orange
Flexibility	Excellent	Good	Fair	Good	Poor
Hand Carvability	Good	Excellent	Fair	Good	Fair
Hardness (Shore D)	52 (Softest)	55	55	58	63 (Hardest)
High-Speed CNC	Poor	Fair	Good	Excellent	Excellent
Viscosity @ 300° (cPs)	3650	3350	1560 (Thinnest)	2030	3550

FILE-A-WAX RING TUBES

Stuller's wax ring tubes offer a comprehensive blend of carving versatility and flexibility. Convenient and easy-to-use, these wax tubes are perfect for designing a wide selection of rings, jewelry, and small art pieces. Ring tubes have a $\frac{5}{16}$ " off-center hole.

Item	Order #	Shape	Color	W x L x H	12+	6+	1+
A	21-1341	T1062E Flat-Sided	Green	$1\frac{1}{16}" \times 6" \times 1\frac{1}{16}"$	\$8.07	\$8.55	\$9.50
	21-1342	Flat-Sided	Purple	$1\frac{1}{16}" \times 6" \times 1\frac{1}{16}"$	\$8.07	\$8.55	\$9.50
	21-1340	Flat-Sided	Blue	$1\frac{1}{16}" \times 6" \times 1\frac{1}{16}"$	\$8.07	\$8.55	\$9.50
B	21-1346	Flat-Sided	Green	$1\frac{1}{8}" \times 6" \times 1\frac{1}{8}"$	\$8.07	\$8.55	\$9.50
	21-1347	Flat-Sided	Purple	$1\frac{1}{8}" \times 6" \times 1\frac{1}{8}"$	\$8.07	\$8.55	\$9.50
	21-1345	Flat-Sided	Blue	$1\frac{1}{8}" \times 6" \times 1\frac{1}{8}"$	\$8.07	\$8.55	\$9.50
C	21-1359	Flat-Sided	Green	$1\frac{1}{8}" \times 6" \times 1"$	\$8.07	\$8.55	\$9.50
	21-1360	Flat-Sided	Purple	$1\frac{1}{8}" \times 6" \times 1"$	\$8.07	\$8.55	\$9.50
	21-1358	Flat-Sided	Blue	$1\frac{1}{8}" \times 6" \times 1"$	\$8.07	\$8.55	\$9.50
D	21-1362	Flat-Sided	Green	$1" \times 6" \times 1"$	\$8.07	\$8.55	\$9.50
	21-1363	Flat-Sided	Purple	$1" \times 6" \times 1"$	\$8.07	\$8.55	\$9.50
	21-1361	Flat-Sided	Blue	$1" \times 6" \times 1"$	\$8.07	\$8.55	\$9.50
E	21-1351	Round Tube	Green	$1\frac{1}{16}" \times 6"$	\$8.07	\$8.55	\$9.50
	21-1352	Round Tube	Purple	$1\frac{1}{16}" \times 6"$	\$8.07	\$8.55	\$9.50
	21-1350	Round Tube	Blue	$1\frac{1}{16}" \times 6"$	\$8.07	\$8.55	\$9.50
F	21-1356	Round Tube	Green	$1\frac{1}{16}" \times 6"$	\$8.07	\$8.55	\$9.50
	21-1357	Round Tube	Purple	$1\frac{1}{16}" \times 6"$	\$8.07	\$8.55	\$9.50
	21-1355	Round Tube	Blue	$1\frac{1}{16}" \times 6"$	\$8.07	\$8.55	\$9.50
G	21-1365	Round Tube	Green	$\frac{7}{8}" \times 6"$	\$8.07	\$8.55	\$9.50
	21-1366	Round Tube	Purple	$\frac{7}{8}" \times 6"$	\$8.07	\$8.55	\$9.50
	21-1364	Round Tube	Blue	$\frac{7}{8}" \times 6"$	\$8.07	\$8.55	\$9.50
H	21-1368	Solid Bar	Green	$1\frac{1}{16}" \times 6"$	\$8.07	\$8.55	\$9.50
	21-1369	Solid Bar	Purple	$1\frac{1}{16}" \times 6"$	\$8.07	\$8.55	\$9.50
	21-1367	Solid Bar	Blue	$1\frac{1}{16}" \times 6"$	\$8.07	\$8.55	\$9.50
J	21-1371	Solid Bar	Green	$\frac{7}{8}" \times 6"$	\$8.07	\$8.55	\$9.50
	21-1372	Solid Bar	Purple	$\frac{7}{8}" \times 6"$	\$8.07	\$8.55	\$9.50
	21-1370	Solid Bar	Blue	$\frac{7}{8}" \times 6"$	\$8.07	\$8.55	\$9.50



Melt temperatures:

Green 230°F

Purple 225°F

Blue 200°F

Shrinkage for:

blue and green – 7-10%

purple – less than 1%

WAX BLOCK KIT

Wax Block Kit: Includes one block each of green, purple, and blue wax.

Student Kit: Features an assortment of 11 pieces of various shapes and sizes. Includes combination of all three hardness grades, blue (regular), green (hard), and purple (medium).

Professional Kit: This kit contains a 14-piece assortment of designers' favorite shapes and sizes. Available in three hardness grades: blue (regular), green (hard), and purple (medium).

Item	Order #	Description	W x L x H	12+	6+	1+
K	21-0207	Wax Block Kit	$1\frac{1}{2}" \times 3\frac{1}{2}" \times 1\frac{1}{4}"$	\$10.30	\$10.75	\$11.20
L	21-0208	Student Kit	Assorted Slices	\$12.42	\$12.96	\$13.50
M	21-0209	Professional Kit	Assorted Slices	\$17.11	\$17.86	\$18.60

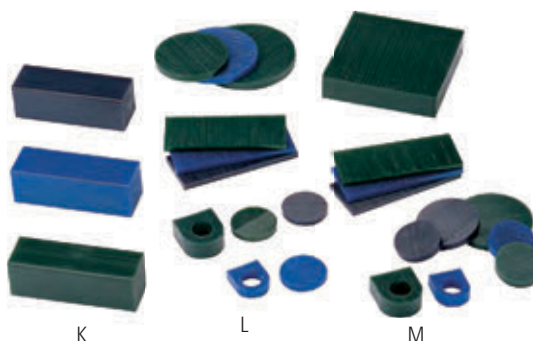

FILE-A-WAX BLOCKS

Ideal for freeform design work, modeling, and rapid prototyping. Available in three hardness grades: blue (regular), green (hard), and purple (medium).

Item	Order #	Color	Weight	W x L x H	12+	6+	1+
N	21-0321	Green	$\frac{1}{2}$ lb	$3\frac{1}{2}" \times 3\frac{1}{2}" \times 1\frac{1}{8}"$	\$8.93	\$9.45	\$10.50
	21-0308	Purple	$\frac{1}{2}$ lb	$3\frac{1}{2}" \times 3\frac{1}{2}" \times 1\frac{1}{8}"$	\$8.93	\$9.45	\$10.50
	21-0320	Blue	$\frac{1}{2}$ lb	$3\frac{1}{2}" \times 3\frac{1}{2}" \times 1\frac{1}{8}"$	\$8.93	\$9.45	\$10.50
P	21-0323	Green	$\frac{1}{2}$ lb	$3\frac{5}{8}" \times 6" \times 1\frac{1}{2}"$	\$13.26	\$14.04	\$15.60
	21-0309	Purple	$\frac{1}{2}$ lb	$3\frac{5}{8}" \times 6" \times 1\frac{1}{2}"$	\$14.88	\$15.75	\$17.50
	21-0322	Blue	$\frac{1}{2}$ lb	$3\frac{5}{8}" \times 6" \times 1\frac{1}{2}"$	\$14.88	\$15.75	\$17.50

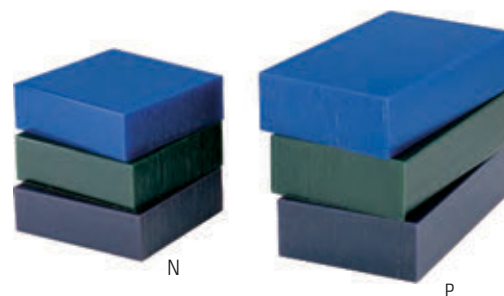

COMPONENTRY WAX

Developed to help the professional wax carver with time they spend on creating channels, clasps, hinges, and other complex precision-formed wax designs. Shapes are sold in blue (medium) and available in 4" - 5" lengths. This full selection of shapes can be used individually or in a combination. Perfect for producing unique jewelry items as well as links, prongs, bezels, and sprues. Although extremely flexible, wire wax is strong enough to be twisted or bent to conform to any configuration or angle without cracking or breaking.

WAX SHAPES

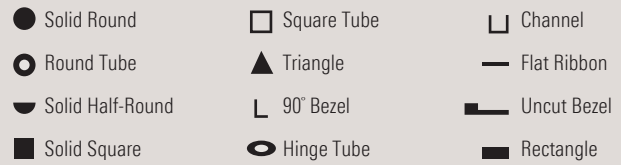

Order # 21-10000

Shape Round

	.5mm	1mm	1.5mm	2mm	2.5mm	3mm	4mm
1+	\$9.75	\$9.75	\$9.75	\$9.75	\$9.75	\$9.75	\$9.75



Order # 21-10001

Shape Round Tube-Center Hole

	1mm	2.5mm	3mm	3.5mm	4mm	4.5mm	5mm	5.5mm	6mm
1+	\$10.60	\$10.60	\$10.60	\$10.60	\$10.60	\$10.60	\$10.60	\$10.60	\$10.60



Order # 21-10002

Shape Half-Round

	2mm	2.5mm	3mm	4mm	6mm
1+	\$9.75	\$9.75	\$9.75	\$9.75	\$9.75



Order # 21-10003

Shape Square

	2mm	2.5mm	3mm	4mm
1+	\$9.75	\$9.75	\$9.75	\$9.75



Order # 21-10004

Shape Square Tube

	2mm	2.5mm	3mm	3.5mm	4mm	4.5mm	5mm	5.5mm	6mm
1+	\$10.70	\$10.70	\$10.70	\$10.95	\$10.95	\$10.70	\$10.70	\$10.95	\$10.70



Order # 21-9159

Shape 90° Bezel

1.5mm

1+ \$10.65



Order # 21-10006

Shape Hinge Tube

2mm

1+ \$10.65



Order # 21-10007

Shape Channel Tube

2.5mm

1+ \$10.65

Order # 21-10005

Shape Triangle

	3mm	3.5mm	4mm	4.5mm
1+	\$9.75	\$9.75	\$9.75	\$9.75



Order # 21-10008

Shape Ribbon

	3mm	4mm	5mm	6mm	7mm
1+	\$9.75	\$9.75	\$9.75	\$9.75	\$9.75



Order # 21-10009

Shape Uncut Bezel

	3mm	4mm	5mm	5.5mm	6mm
1+	\$9.75	\$9.75	\$9.75	\$9.75	\$9.75



Order # 21-10010

Shape Rectangle

	2.5mm	3mm	4mm	5mm	6mm
1+	\$9.75	\$9.75	\$9.75	\$9.75	\$9.75



Casting

**STULLER SELECT CASTING WAX SHEETS**

High-grade, translucent, flexible casting wax sheets are used by jewelry designers for a wide variety of applications and are always pliable at room temperature. Each sheet measures 4" square. 1 Box = 32 sheets.

Assortment Size: 4 - 14 gauge, 4 - 18 gauge, 6 - 20 gauge, 6 - 22 gauge, and 6 - 24 gauge, 6 - 26 gauge

Order #	Wax Gauge	12+	6+	1+
21-0440	14 Gauge	\$16.93	\$17.66	\$18.40
21-0441	16 Gauge	\$16.93	\$17.66	\$18.40
21-0442	18 Gauge	\$16.93	\$17.66	\$18.40
21-0443	20 Gauge	\$16.93	\$17.66	\$18.40
21-0444	24 Gauge	\$16.93	\$17.66	\$18.40
21-0445	26 Gauge	\$16.93	\$17.66	\$18.40
21-0446	28 Gauge	\$16.93	\$17.66	\$18.40
21-0449	Casting Wax Assortment	\$16.93	\$17.66	\$18.40

**STULLER SELECT STICKY WAX**

A quick-setting adhesive that creates a rigid bond between two wax surfaces. This wax is a must when creating complex assemblies or attaching patterns to your sprue rod. Sticky wax will not hinder melt-out, leaves no residue, and is ideal for both large and small parts. Melting temperature 161°F.

Order #	Description	W x L	12+	6+	1+
21-0382	Stick	¼" x 5"	\$9.94	\$10.37	\$10.80
21-0383	Chunks (1 lb)	¼" x 5"	\$12.56	\$13.10	\$13.65

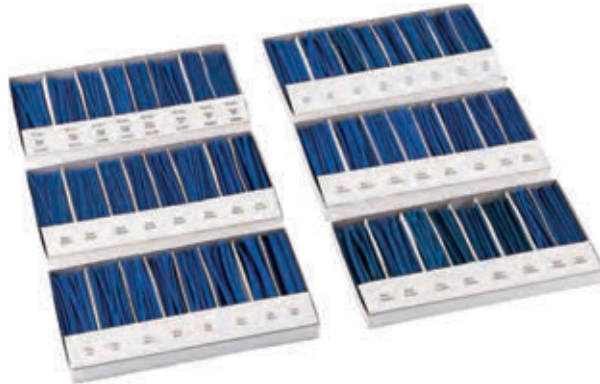
**WAX WIRE ASSORTMENTS**

The assortment packs ensure you have a convenient selection of wire waxes when you need them. Each box contains 8 different gauges of Stuller Select wire waxes cut in 4" lengths.

No. 1 Assortment: 10, 14, 18 gauge; Half-round: 6, 8, 12, and 14 gauge; Half-pear: 6 gauge

No. 2 Assortment: 6, 8, 10, 12, 14, 16, 18, and 20 gauge

No. 3 Assortment: 2, 4, 6, 8, 10, and 12 gauge; Square: 12 and 14 gauge

No. 4 Assortment: 2, 4, 6, 8, and 10 gauge; Bezel: 6, 8, and 10 gauge

No. 5 Assortment: 8, 12, 14, and 18 gauge;

Half-round: 6, 8, 12, and 14 gauge

No. 6 Assortment: 8, 10, and 12 gauge; 3-Prong:

14 and 16 gauge; 4-Prong: 16 and 18 gauge; 6-Prong: 16 gauge



Order #	Description	1+
21-0260	No. 1 Round	\$22.45
21-0261	No. 2 Round	\$14.55
21-0262	No. 3 Rectangle	\$14.20
21-0263	No. 4 Uncut Bezel	\$14.20
21-0264	No. 5 Round	\$14.20
21-0265	No. 6 Triangle	\$14.20

WAX CONVERSION CHART

1 dwt	Multiply by	GAUGE/ MILLIMETER SIZE
Sterling Silver	10.36	1 Gauge / 7.34 mm
10kt yellow	11.60	2 Gauge / 6.35 mm
14kt white	12.65	3 Gauge / 5.83 mm
14kt yellow	13.08	4 Gauge / 5.18 mm
18kt white	14.65	6 Gauge / 4.12 mm
18kt yellow	15.60	8 Gauge / 3.25 mm
Palladium	12.20	10 Gauge / 2.6 mm
Platinum (10% Ir)	21.50	12 Gauge / 2.06 mm
Platinum (5% Ir)	21.50	14 Gauge / 1.6 mm
		16 Gauge / 1.3 mm
		18 Gauge / 1.0 mm
		20 Gauge / 0.8 mm
		24 Gauge / 0.5 mm

WAX SHAPES

● Solid Round	□ Square Tube	└ Channel
○ Round Tube	▲ Triangle	— Flat Ribbon
◐ Solid Half-Round	└ 90° Bezel	└ Uncut Bezel
■ Solid Square	○ Hinge Tube	■ Rectangle

STULLER FILE-A-WAX DESIGNER SHAPES BY FERRIS

Stuller Select designer shapes provide a selection of basic shapes that are perfect for large, custom design work. These shapes afford the ability to respond quickly to design assignments or to creative inspirations. Available in blue (regular), green (hard), and purple (medium). Specify color when ordering.

Item	Order #	Color	Shape	W x L x H	12+	6+	1+
A	21-0710	Blue	Slices	5 $\frac{3}{16}$ " Assorted	\$13.35	\$14.13	\$15.70
	21-0711	Green	Slices	5 $\frac{3}{16}$ " Assorted	\$13.35	\$14.13	\$15.70
	21-0712	Purple	Slices	5 $\frac{3}{16}$ " Assorted	\$13.35	\$14.13	\$15.70
B	21-0714	Green	Bar	2 $\frac{1}{4}$ " x 7 $\frac{1}{2}$ "	\$13.26	\$14.04	\$15.60
	21-0715	Purple	Bar	2 $\frac{1}{4}$ " x 7 $\frac{1}{2}$ "	\$13.26	\$14.04	\$15.60
	21-0713	Blue	Bar	2 $\frac{1}{4}$ " x 7 $\frac{1}{2}$ "	\$13.26	\$14.04	\$15.60
	21-0717	Green	Bar	1 $\frac{5}{16}$ " x 11 $\frac{1}{4}$ "	\$13.26	\$14.04	\$15.60
	21-0718	Purple	Bar	1 $\frac{5}{16}$ " x 11 $\frac{1}{4}$ "	\$13.26	\$14.04	\$15.60
	21-0716	Blue	Bar	1 $\frac{5}{16}$ " x 11 $\frac{1}{4}$ "	\$13.26	\$14.04	\$15.60
C	21-0720	Green	Half-Round	4 $\frac{5}{8}$ " x 3 $\frac{1}{8}$ " x 2 $\frac{5}{8}$ "	\$13.26	\$14.04	\$15.60
	21-0721	Purple	Half-Round	4 $\frac{5}{8}$ " x 3 $\frac{1}{8}$ " x 2 $\frac{5}{8}$ "	\$13.26	\$14.04	\$15.60
	21-0719	Blue	Half-Round	4 $\frac{5}{8}$ " x 3 $\frac{1}{8}$ " x 2 $\frac{5}{8}$ "	\$13.26	\$14.04	\$15.60
	21-0723	Green	Half-Round	3 $\frac{5}{8}$ " x 2 $\frac{3}{4}$ " x 3 $\frac{5}{8}$ "	\$15.51	\$16.43	\$18.25
	21-0724	Purple	Half-Round	3 $\frac{5}{8}$ " x 2 $\frac{3}{4}$ " x 3 $\frac{5}{8}$ "	\$13.26	\$14.04	\$15.60
	21-0722	Blue	Half-Round	3 $\frac{5}{8}$ " x 2 $\frac{3}{4}$ " x 3 $\frac{5}{8}$ "	\$15.51	\$16.43	\$18.25
D	21-0726	Green	Block	3 $\frac{3}{16}$ " x 3 $\frac{3}{16}$ " x 2 $\frac{3}{8}$ "	\$13.26	\$14.04	\$15.60
	21-0727	Purple	Block	3 $\frac{3}{16}$ " x 3 $\frac{3}{16}$ " x 2 $\frac{3}{8}$ "	\$13.26	\$14.04	\$15.60
	21-0725	Blue	Half-Round	3 $\frac{3}{16}$ " x 3 $\frac{3}{16}$ " x 2 $\frac{3}{8}$ "	\$13.26	\$14.04	\$15.60

**STULLER FILE-A-WAX UTILITY WAX BY FERRIS**

Easily shaped waxes that are specially suited for fill-ins and wax repair. Utility waxes can be used to easily correct mistakes or apply sprues to sprue bases. Pliable at room temperature.

Item	Order #	Description	W x L x Thickness	Weight	12+	6+	1+
E	21-0392	Thin	3" x 6" x $\frac{1}{8}$ "	$\frac{1}{2}$ lb	\$8.00	\$8.35	\$8.70
F	21-0393	Regular	3" x 6" x $\frac{3}{16}$ "	$\frac{1}{2}$ lb	\$8.10	\$8.45	\$8.80
G	21-0394	Sticks	3" x 6" x $\frac{3}{16}$ "	8 oz	\$11.64	\$12.14	\$12.65

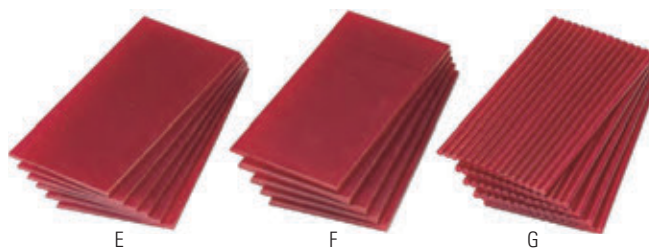
**STULLER FILE-A-WAX SLICE ASSORTMENT**

Half-Pound Kit Assortment: 1 $\frac{3}{16}$ " H x 3 $\frac{3}{16}$ " W wax sliced in thicknesses from $\frac{1}{8}$ " to $\frac{1}{4}$ ". Kit consists of: 6 pieces - 0.280" (7.1mm), 6 pieces - 0.200" (5.1mm), and 6 pieces - 0.135" (3.4mm).

One-Pound Kit Assortment: 1 $\frac{3}{16}$ " W x 3 $\frac{5}{8}$ " L in thicknesses from $\frac{3}{16}$ " to 1". Each kit contains: 1 piece - 1" (25.4mm) thick; 3 pieces - 0.700" (17.8mm) thick; 4 pieces - 0.280" (7.1mm), 4 pieces - 0.190" (4.8mm), 4 pieces - 0.140" (3.6mm).

Order #	Color	Net Weight	Per Pack	12+	6+	1+
21-0325	Green	$\frac{1}{2}$ lb	18 slices	\$14.35	\$14.98	\$15.60
21-0326	Purple	$\frac{1}{2}$ lb	18 slices	\$14.35	\$14.98	\$15.60
21-0324	Blue	$\frac{1}{2}$ lb	18 slices	\$14.35	\$14.98	\$15.60
21-0328	Green	1 lb	16 slices	\$14.81	\$15.46	\$16.10
21-0329	Purple	1 lb	16 slices	\$14.81	\$15.46	\$16.10
21-0327	Blue	1 lb	16 slices	\$14.81	\$15.46	\$16.10

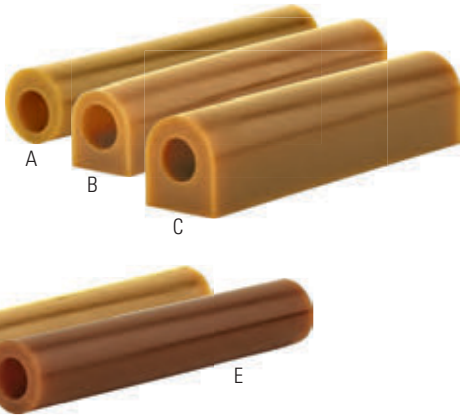

Casting

**WOLF™ WAX RING TUBES AND SOLID BAR**

This carving wax melts at approximately 240°F and is available in many sizes. It has medium hardness and flexibility, and is ideal for extremely fine detail, piercing, and carvability.

Item	Order #	Description	Color	W x L	12+	6+	1+
A	21-0480	Ring Tube w/ Off-Center Hole	Gold	1 1/8" x 6"	\$9.44	\$9.99	\$11.10
B	21-0482	Flat Top Ring Tube	Gold	1" x 6"	\$9.44	\$9.99	\$11.10
C	21-0484	Flat Top Ring Tube (EH)	Gold	1 1/8" x 6"	\$10.21	\$10.66	\$11.10
D	21-0476	Solid Ring Tube	Gold	1 1/8" x 6"	\$9.44	\$9.99	\$11.10
E	21-0478	Ring Tube w/ Center Hole	Gold	1 1/8" x 6"	\$9.44	\$9.99	\$11.10

WOLF™ WAX SPACE BLOCKS

Order #	Color	W x L x Depth	Weight	12+	6+	1+
21-0470	Gold	3 3/16" x 3 3/16" x 2 3/8"	1 lb	\$16.45	\$17.42	\$19.35

**WOLF™ WAX SLICE ASSORTMENT SET**

Order #	Color	W x L	Depth	12+	6+	1+
21-0474	Gold	1 7/16" x 3 3/8"	1/8" to 1"	\$16.45	\$17.42	\$19.35

**WOLF™ WAX BUILD-UP/REPAIR WAX**

This durable repair wax makes it easy to blend built-up and repaired sections. To ensure thorough bond, melt model where repair wax is to be added.

Order #	Color	W x L x Depth	Weight	12+	6+	1+
21-0486	Gold	3 3/4" x 1 3/16" x 1 3/16"	3 oz	\$9.48	\$10.04	\$11.15

**WOLF™ WICKED STICKY POSITIONING WAX**

Ideal for securing stones for accurate tracing. Smear wax on stone, press stone onto the wax or metal, and scribe around the stone.



Order #	Depth	Shape	Length	Flow	12+	6+	1+
21-0488	3/16"	Square	5"	173° F (78° C)	\$16.58	\$17.55	\$19.50

**WOLF™ WAX**

Ideal for creating raised detail on carving waxes or the final touch-up of wax imperfections such as pits and cracks or to flow inside bezel walls for a tighter fit. Apply molten relief wax onto surface of the wax model. Can be easily carved. Touch-Up Wax can be easily scraped off for a smooth finish.

Item	Order #	Description	Flow	Weight	12+	6+	1+
F	21-0489	Touch-Up Wax	163° F (73° C)	1.7 oz	\$14.88	\$15.75	\$17.50
G	21-0490	Relief Wax	163° F (73° C)	1.7 oz	\$14.88	\$15.75	\$17.50



WOLF™ PRECISION CARVERS

Designed by Kate Wolf, master model maker and educator. These tools have the profiles and edges that wax carvers have been waiting for. Wolf's Precision Carvers are made of chromium and manganese, and the wood handles are color coded and numbered for quick identification. Set A includes: container and 22-page, 7" x 7", full-color instructional booklet.

Item	Order #	Description	12+	6+	1+
A	21-0495	18-piece Carvers Set	\$131.75	\$139.50	\$155.00
B	21-0508	8-piece Micro Carvers set	\$67.96	\$71.96	\$79.95
C	21-0496	22-Page Instruction Booklet (only)	\$11.31	\$11.97	\$13.30
D	21-1411	#1 Scribe/Detailing	\$10.29	\$10.89	\$12.10
E	21-1412	#2 Small 90°	\$10.29	\$10.89	\$12.10
F	21-1413	#3 Carving Knife	\$10.29	\$10.89	\$12.10
G	21-1414	#4 Diamond Point	\$10.29	\$10.89	\$12.10
H	21-1415	#5 Medium Hollower	\$10.29	\$10.89	\$12.10
J	21-1416	#6 Medium Rake Hollower	\$10.29	\$10.89	\$12.10
K	21-1417	#7 Detailing Knife	\$10.29	\$10.89	\$12.10
L	21-1418	#8 Small Hollower	\$10.29	\$10.89	\$12.10
M	21-1419	#9 Small Rake Hollower	\$10.29	\$10.89	\$12.10
N	21-1420	#10 Medium 90° /Safety Edge	\$10.29	\$10.89	\$12.10
P	21-1421	#11 Pavilion/Safety Edge	\$10.29	\$10.89	\$12.10
Q	21-1422	#12 Tapered Triangle	\$10.29	\$10.89	\$12.10
R	21-1423	#13 Small Rounding	\$10.29	\$10.89	\$12.10
S	21-1424	#14 Medium Rounding	\$10.29	\$10.89	\$12.10
T	21-1425	#15 Undercutting	\$10.29	\$10.89	\$12.10
U	21-1426	#16 Concave/Convex	\$10.29	\$10.89	\$12.10
V	21-1427	#17 Large Hollower	\$10.29	\$10.89	\$12.10

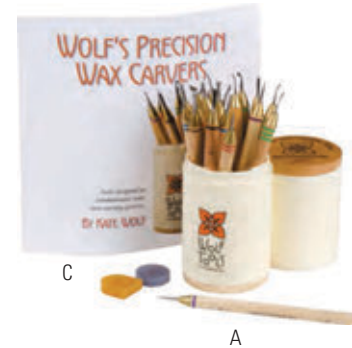

WOLF™ TRIMMER

Multipurpose tool for quickly and accurately trimming carving waxes and other applications now made easier by its ability to securely position rotary tools. The Wolf Trimmer is a simple tool designed extraordinarily well for holding a #30 handpiece in use. Made primarily for trimming waxes while using a 11mm diameter cylinder bur (not supplied), the Wolf Trimmer will also work with a variety of rotary tools, allowing you to use both hands and precisely locate items next to a stationary tool.

Order #	Description	12+	6+	1+
21-0455	Trimmer	\$35.70	\$37.80	\$42.00



WOLF™ ADJUSTABLE TRIMMER

Made of aluminum, steel, and plastic. It has a removable rip fence for controlled cutting. The pivoting, sliding table adjusts from 90°- 45° for complex cuts. The Wolf Adjustable Trimmer and the Wolf Trimmer slide over a #30 flex shaft handpiece. Either can be handheld against a bench pin or tabletop, or held in a GRS® BenchMate™. Use with cylinder bur to quickly and accurately trim carving wax. Use with separating disks on metal to cut grooves for inlay and channels. Use with abrasives for finish work on metal.

Order #	Description	12+	6+	1+
21-0456	Adjustable Trimmer	\$97.75	\$103.50	\$115.00



Casting

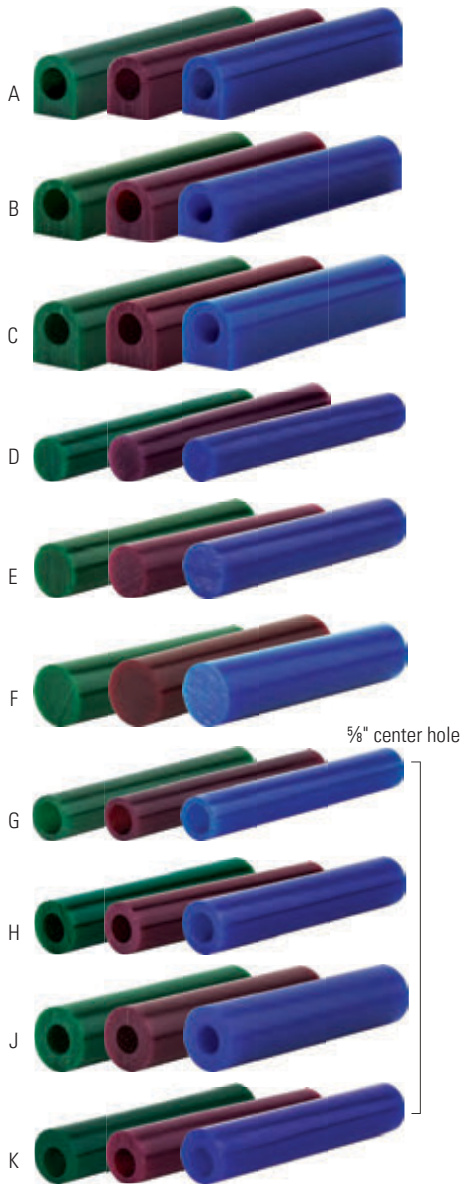

MATT™ WAX RING TUBES

Available in three degrees of flexibility: green (hard); purple (medium); and blue (soft). Specify color when ordering.

Item	Order #	Shape	Color	W x L x H	12+	6+	1+
A	21-0215	Flat-Sided Tube	Green	1" x 6" x 1 1/8"	\$6.46	\$6.84	\$7.60
	21-0216	Flat-Sided Tube	Purple	1" x 6" x 1 1/8"	\$6.46	\$6.84	\$7.60
	21-0217	Flat-Sided Tube	Blue	1" x 6" x 1 1/8"	\$6.46	\$6.84	\$7.60
B	21-0218	Flat-Sided Tube	Green	1 1/8" x 6" x 1 1/8"	\$6.46	\$6.84	\$7.60
	21-0219	Flat-Sided Tube	Purple	1 1/8" x 6" x 1 1/8"	\$6.46	\$6.84	\$7.60
	21-0220	Flat-Sided Tube	Blue	1 1/8" x 6" x 1 1/8"	\$6.46	\$6.84	\$7.60
C	21-0221	Flat-Sided Tube	Green	1 1/8" x 6" x 1 1/4"	\$6.46	\$6.84	\$7.60
	21-0222	Flat-Sided Tube	Purple	1 1/4" x 6" x 1 1/4"	\$6.46	\$6.84	\$7.60
	21-0223	Flat-Sided Tube	Blue	1 1/4" x 6" x 1 1/4"	\$6.46	\$6.84	\$7.60
D	21-0224	Solid Round Tube	Green	7/8" x 6"	\$6.46	\$6.84	\$7.60
	21-0225	Solid Round Tube	Purple	7/8" x 6"	\$6.46	\$6.84	\$7.60
	21-0226	Solid Round Tube	Blue	7/8" x 6"	\$6.46	\$6.84	\$7.60
E	21-0227	Solid Round Tube	Green	1 1/16" x 6"	\$6.46	\$6.84	\$7.60
	21-0228	Solid Round Tube	Purple	1 1/16" x 6"	\$6.46	\$6.84	\$7.60
	21-0229	Solid Round Tube	Blue	1 1/16" x 6"	\$6.46	\$6.84	\$7.60
F	21-0230	Solid Round Tube	Green	1 5/16" x 6"	\$6.46	\$6.84	\$7.60
	21-0231	Solid Round Tube	Purple	1 5/16" x 6"	\$6.46	\$6.84	\$7.60
	21-0232	Solid Round Tube	Blue	1 5/16" x 6"	\$6.46	\$6.84	\$7.60
G	21-0233	Round Tube-Center Hole	Green	7/8" x 6"	\$6.46	\$6.84	\$7.60
	21-0234	Round Tube-Center Hole	Purple	7/8" x 6"	\$6.46	\$6.84	\$7.60
	21-0235	Round Tube-Center Hole	Blue	7/8" x 6"	\$6.46	\$6.84	\$7.60
H	21-0238	Round Tube-Center Hole	Green	1 1/16" x 6"	\$6.46	\$6.84	\$7.60
	21-0239	Round Tube-Center Hole	Purple	1 1/16" x 6"	\$6.46	\$6.84	\$7.60
	21-0245	Round Tube-Center Hole	Blue	1 1/16" x 6"	\$6.46	\$6.84	\$7.60
J	21-0246	Round Tube-Center Hole	Green	1 5/16" x 6"	\$6.46	\$6.84	\$7.60
	21-0247	Round Tube-Center Hole	Purple	1 5/16" x 6"	\$6.46	\$6.84	\$7.60
	21-0248	Round Tube-Center Hole	Blue	1 5/16" x 6"	\$6.46	\$6.84	\$7.60
K	21-0249	Round Tube-Off Center Hole	Green	1 1/16" x 6"	\$6.46	\$6.84	\$7.60
	21-0257	Round Tube-Off Center Hole	Purple	1 1/16" x 6"	\$6.46	\$6.84	\$7.60
	21-0258	Round Tube-Off Center Hole	Blue	1 1/16" x 6"	\$6.46	\$6.84	\$7.60

Available in three degrees of flexibility. Specify color when ordering.

Green (hard), 7-10% shrink | Purple (medium), 1% shrink | Blue (soft), 7-10% shrink

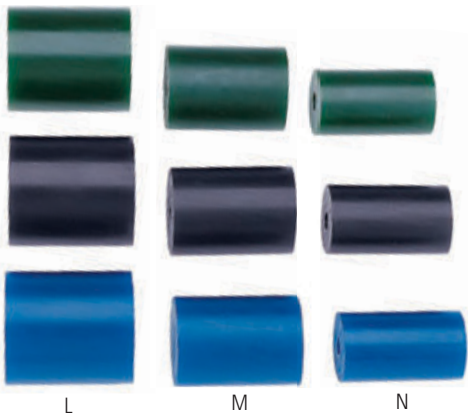

MATT™ WAX RODS

Designed for use with the Matt™ mini-lathe (page 138, 21-2800). Each box contains four 1 1/2" long rods. Specify color (green, purple, or blue) when ordering.

Item	Order #	Width	Color	12+	6+	1+
L	21-0531	1 5/16"	Green (hard)	\$8.30	\$9.00	\$10.00
	21-0532	1 5/16"	Purple (medium)	\$8.30	\$9.00	\$10.00
	21-0533	1 5/16"	Blue (soft)	\$8.30	\$9.00	\$10.00
M	21-0534	1 3/32"	Green (hard)	\$8.30	\$9.00	\$10.00
	21-0535	1 3/32"	Purple (medium)	\$8.30	\$9.00	\$10.00
	21-0536	1 3/32"	Blue (soft)	\$8.30	\$9.00	\$10.00
N	21-0537	7/8"	Green (hard)	\$8.30	\$9.00	\$10.00
	21-0538	7/8"	Purple (medium)	\$8.30	\$9.00	\$10.00
	21-0539	7/8"	Blue (soft)	\$8.30	\$9.00	\$10.00

MATT™ BRACELET WAX BARS

Designed for use with the Matt™ shape, these six-inch long, arch-shaped bars simplify the construction of bracelets. Create round, oval, and square designs in a variety of sizes.

Order #	Color	Length	Weight	12+	6+	1+
21-0519	Green (hard)	6"	1 lb	\$14.86	\$16.11	\$17.90
21-0520	Purple (medium)	6"	1 lb	\$14.86	\$16.11	\$17.90
21-0521	Blue (soft)	6"	1 lb	\$14.86	\$16.11	\$17.90

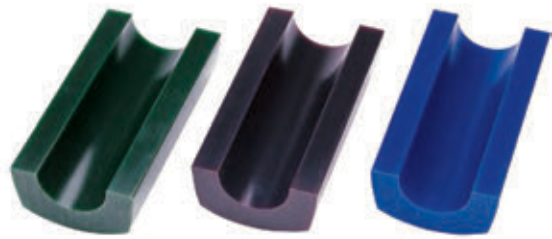
**MATT™ WAX SLICES**

Slices assorted from 1/8" to 1/2" in thickness.



Order #	Color	W x L	Weight	12+	6+	1+
21-0266	Green (hard)	1 7/16" x 3 1/8"	1/2 lb	\$10.26	\$10.70	\$11.15
21-0267	Purple (medium)	1 7/16" x 3 1/8"	1/2 lb	\$10.26	\$10.70	\$11.15
21-0268	Blue (soft)	1 7/16" x 3 1/8"	1/2 lb	\$10.26	\$10.70	\$11.15

**MATT™ WAX BARS**

A special wax used for making models. Can be carved, sawed, filed, machined, or turned on a lathe. Available in three grades of flexibility: green, purple, and blue. Specify color when ordering.

Item	Order #	Description	W x L x H	12+	6+	1+
A	21-0433	1/2 lb Bar	3 3/8" x 3 3/8" x 1 1/16"	\$8.69	\$9.07	\$9.45
	21-0434	1/2 lb Bar	3 3/8" x 3 3/8" x 1 1/16"	\$8.69	\$9.07	\$9.45
	21-0435	1/2 lb Bar	3 3/8" x 3 3/8" x 1 1/16"	\$8.69	\$9.07	\$9.45
B	21-0430	1 lb Bar	3 3/8" x 6 1/2" x 1 1/16"	\$12.14	\$12.67	\$13.20
	21-0431	1 lb Bar	3 3/8" x 6 1/2" x 1 1/16"	\$12.14	\$12.67	\$13.20
	21-0432	1 lb Bar	3 3/8" x 6 1/2" x 1 1/16"	\$12.14	\$12.67	\$13.20

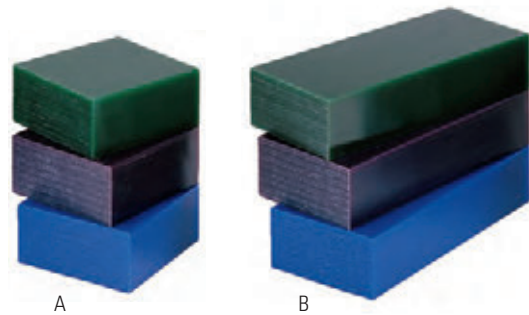
**MATT™ WAX CARVING TABLETS**

These smooth, precision wax tablets provide jewelry designers and model makers with large, flat, incredibly smooth surfaces for designing jewelry directly onto carving wax. The tablets save time and money by eliminating the filing and surface preparation that is required with standard wax slices. The tablet size is produced in four thicknesses: 4.5mm, 6mm, 8mm, and 10.5mm. Available in three assorted sets.

Specify color (green, purple, or blue) when ordering.

Set C contains thickness of 3-4.5mm, 1-8mm, 1-10.5mm

Set D contains thickness of 4-4.5mm, 3-6mm

Set E contains thickness of 2-8mm, 2-10.5mm

Item	Order #	W x L	Color	12+	6+	1+
C	21-0522	2 5/8" x 6"	Green (hard)	\$24.52	\$25.58	\$26.65
	21-0523	2 5/8" x 6"	Purple (medium)	\$24.52	\$25.58	\$26.65
	21-0524	2 5/8" x 6"	Blue (soft)	\$24.52	\$25.58	\$26.65
D	21-0525	2 5/8" x 6"	Green (hard)	\$24.52	\$25.58	\$26.65
	21-0526	2 5/8" x 6"	Purple (medium)	\$24.52	\$25.58	\$26.65
	21-0527	2 5/8" x 6"	Blue (soft)	\$24.52	\$25.58	\$26.65
E	21-0528	2 5/8" x 6"	Green (hard)	\$24.52	\$25.58	\$26.65
	21-0529	2 5/8" x 6"	Purple (medium)	\$24.52	\$25.58	\$26.65
	21-0530	2 5/8" x 6"	Blue (soft)	\$24.52	\$25.58	\$26.65

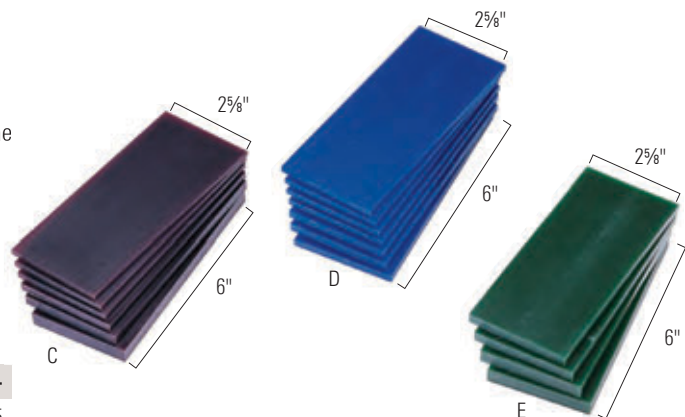

Available in three degrees of flexibility. Specify color when ordering.

Green (hard), 7-10% shrink Purple (medium), 1% shrink
Blue (soft), 7-10% shrink

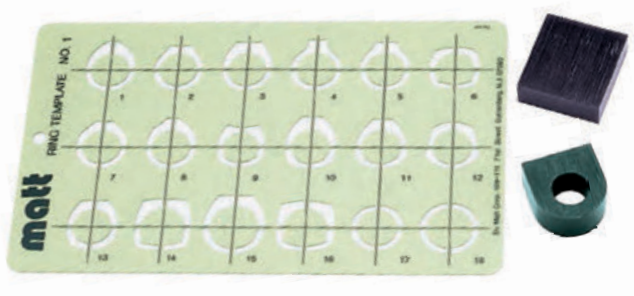
**MATT™ RING TEMPLATE**

Features 18 different profiles for both men's and ladies' rings, from the most popular to universal designs.

Order #	Description	W × L	1+
21-0279	Ring Template	5" × 8¼"	\$13.10

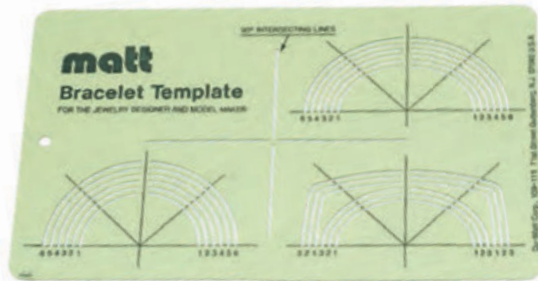
**MATT™ BRACELET TEMPLATE**

This bracelet template helps you establish the perfect profile for creating square, round, and oval bracelets. Conveniently sized for most bracelet projects.

Order #	Description	W × L	1+
21-0269	Bracelet Template	5" × 8¼"	\$13.50

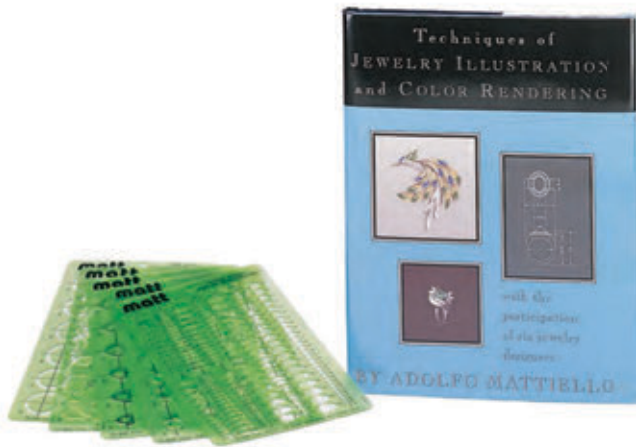
**MATT™ TECHNIQUES OF JEWELRY ILLUSTRATION AND COLOR RENDERING KIT**

Features full instruction on jewelry illustration, with step-by-step guidelines and clear illustrations. 152 pages with hardcover presenting full instructions on jewelry rendering and design ideas. Includes five design templates.

Order #	Description	1+
21-0540	Rendering Kit	\$99.00
21-0541	Book Only	\$44.90
21-0542	Set of 5 Templates	\$66.00

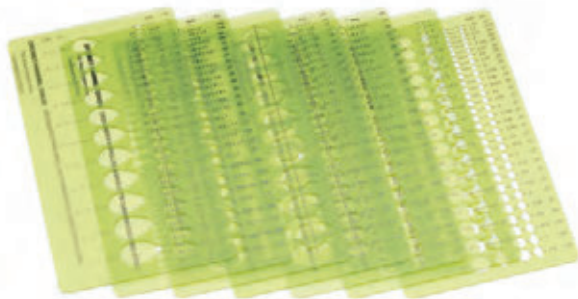
**JEWELRY DESIGN TEMPLATE KIT**

Allows accurate drawings of jewelry designs. Kit of seven, heavy-gauge plastic templates. Includes shapes as follows: round, oval, baguette, emerald, marquise, and pear. Templates for ring and setting designs are also included along with metric and carat equivalents for accuracy and convenience.

Order #	Description	1+
35-5700	Design Templates	\$60.20

MATT™ WAX ROD CENTERING TOOL

Allows exact alignment of the mini-lathe's wax-holding collet in the wax rod. Accommodates and precisely centers all three rod diameters.

Order #	Description	1+
21-0548	Centering Tool	\$37.75

**MATT™ WAX REAMER**

With the Matt Reamer you can quickly create perfect wax blanks with smooth parallel walls, and bore finger sizes (to the exact dimensions) straight through the blanks. You can also create bezels for round stones or coin holders. The reamer consists of a precision ground steel rod with a holding knob. Two specially designed carbide blades ensure the tool's precision and long life.

Order #	Description	1+
21-2835	Reamer	\$64.35

**MATT™ RING TUBE SIZER**

Enlarge the finger size of your wax models quickly and accurately. Hardwood mandrel is specially machined to incorporate a cutting steel blade that extends from the handle to the tip on the tapered section. Slide this tool through the hole of wax ring or ring tube and gently rotate clockwise. As the blade turns it scribes inner wall, enlarging the ring to the size that is marked along the mandrel, leaving a smooth and even finish on the ring.

Order #	Description	1+
21-2895	Matt Ring Tube Sizer	\$33.50

**MATT™ MITER BOX**

Slices bars, rods, and wax ring tubes into perfectly straight tablets and parallel walls or tapered sides. The Miter Box holds ring tube firmly in position inside the box, so there is no strain on your hands. The miter box has a stop/lock feature for cutting several tablets of the same thickness. The fine steel saw blades allow you to cut through the tube with no effort, leaving a smooth finish without filing.

Order #	Description	W x L	1+
21-0390	Box and Saw	6" x 2"	\$69.00

**MATT™ GUN KIT**

Versatile, extrusion technique for creating models is provided to you through the use of the Matt Gun. Allows you to individually control the temperature and pressure of the extrusion process. Three different methods of design can be achieved: on objects, freeform, and on water. Kit contains Matt Gun, two brass tips, three styles of wax, and a 113-page instruction book. 110V.

Order #	Description	1+
21-0955	Matt Gun Kit	\$165.00

REPLACEMENTS

21-0956	Blue Pellets for Mandrel Design (pack of 20)	\$9.80
21-0957	Green Pellets for Water Design (pack of 20)	\$9.80
21-0958	Red Pellets for Weaving (pack of 20)	\$9.80

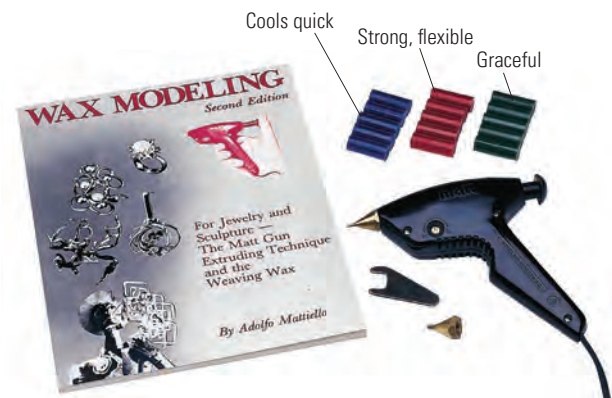

Casting

**MATT™ MINI LATHE WITH GAUGE KIT**

The handheld lathe works with a flex shaft and a #30 handpiece and is used for the design of wedding bands, bezels, coin holders, and pieces as large as a chess piece. Comes with a three-piece cutting tool and a 32-page instruction book. Handpiece is not included. 115V.

Item	Order #	Description	1+
A	21-2800	Mini Lathe with Gauge Kit (shown)	\$165.00

REPLACEMENT PARTS

B	21-0544	Blade Set (3-Pieces)	\$18.70
C	21-0545	Wax Holding Collet	\$6.50
D	21-0546	Cutting Tool Square End	\$6.60
E	21-0547	Cutting Tool Blank End	\$4.75
	21-2817	Green Replacement Wax Rods (4-Pieces)	\$11.80
	21-2812	Purple Replacement Wax Rods (4-Pieces)	\$11.80
	21-2822	Blue Replacement Wax Rods (4-Pieces)	\$11.80

**MATT™ TRIMMER SET**

Files flat and curved surfaces at different angles. This unit comes with a rotary file, three different waxes, instructions, and is powered by a flex shaft and No. 30 handpiece. Handpiece and cable not supplied with unit. 115V.

Order #	Description	1+
21-2880	Matt Trimmer Set	\$160.00

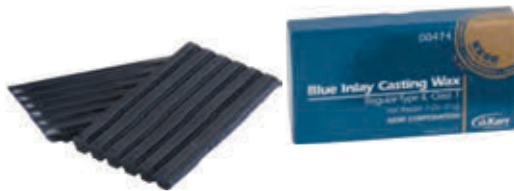
**KERR® INLAY WAX**

Superior build-up wax. Excellent for repairing. Inlay wax has excellent carvability without chipping or flaking. Solidifies at 144°F (62.2°C). Melting point 163°F (72.8°C).

Order #	OD x Length	12+	6+	1+
21-0250	¼" x 3"	\$14.49	\$15.12	\$15.75

Great with synthetic paraffin wax.

**KERR® DISCLOSING WAX**

A creamy wax used to repair wax pattern defects. Low melting temperature. Detects high spots; fills voids in waxes. Applies easily with wax tools or finger.

Order #	Description	Size	12+	6+	1+
21-0256	Repair Wax	2 oz	\$30.04	\$31.34	\$32.65

**KERR® PERFECT PURPLE**

Excellent build-up wax that carves easily. Used especially when multiple layers of build-up is required. Produces smooth surfaces. Melting point 156°F (68.9°C).

Order #	Description	W x L x H	12+	6+	1+
21-0255	Build-Up Wax	1" x 3" x 1"	\$28.15	\$29.38	\$30.60

**SCULPTURE WAX STRIPS**

Soft, pliable wax that is easily formed and shaped by hand without the use of heat. Perfect for forming large models.

Order #	Description	W x L x H	12+	6+	1+
21-6550	Sculpture Wax	¼" x 24" x ¼"	\$17.62	\$18.38	\$19.15

COMPASS CUTTER

Capable of cutting circles from 1 cm up to 6 inches in diameter from paper, film, wax sheets, and other thin materials. Comes complete with five spare blades.

Order #	Description	1+
39-1820	Compass Cutter	\$12.00

**DOUBLE-END WAX CARVER SET**

Seven excellent professional tools that offer design versatility and a hardwood stand that includes a sharpening stone.

Order #	Description	Length	1+
21-1127	Carvers Set with Stand	6"	\$29.00
52-1012	Hardwood Stand	6"	\$10.65

**WAX CARVER SET**

Made of high-grade, non-corrosive stainless steel, this wax carver set features all new shapes that cut or scrape waxes. Various tip designs give you the ability to work in tight places. Ergonomic handles provide a firm but pleasant grip. All tips feature sharp edges to cut properly.

Order #	Description	Length	1+
21-1125	Wax Carvers (6-Pieces)	6"	\$23.25

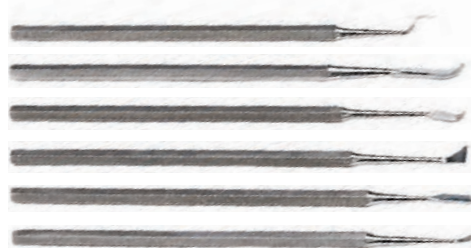
**WAX CARVING TOOLS**

Set contains four shapes, two sizes of each. Allows the user to actually carve the wax rather than scrape it away since the loops are sharp on one edge. Used to make and smooth designs, or use with wax lathes for making rings. Made of surgical-grade stainless steel with a sure-grip handle.

Order #	Description	1+
21-1100	Wax Carving Tools (4-Pieces)	\$24.00

**WAX DETAILER SET**

Excellent tool for filing waxes. Points are stainless steel and spiral with file-like edges. They are small enough to file in tiny corners, crevices and holes where other tools and files cannot reach. Set includes a fine detailer and an extra fine detailer. The fine detailer has a 1.2mm shaft, and the extra fine has a 0.8mm shaft. Comfortable wood handle measures 4". Made in the USA.

Order #	Description	Length	1+
21-1000	Wax Detailers (2-Pieces)	5"	\$12.00

**WAX CARVERS AND PROBES**

Set of six popular carvers and probes for wax work. Ideal for design and touch-up. Made of stainless steel.

Item	Order #	Description	Length	1+
	21-1120	Wax Carvers and Probes (6-Pieces)		\$29.75
A	21-1140	#3 Carver	6½"	\$6.35
B	21-2520	#17 Probe	5¾"	\$3.05
C	21-2510	#6 Probe	5½"	\$3.05
D	21-1150	#5 Carver	6½"	\$6.35



Casting

**WALLER SCRIBER**

Used to scribe hard metal, glass, and stone. Reversible ends for protection while carrying.

Order #	Description	Length	1+
52-9500	Scriber	6"	\$6.60

**DOUBLE-ENDED STEEL TRACER**

Twisted center allows firm grip. Ends are finely honed. Overall length is 6½".

Order #	Description	Length	1+
52-9660	Tracer	6½"	\$9.50

**STARRET DIVIDER**

Highly-polished dividers made of spring steel with hardened, tempered, and well-balanced round legs. Floating washer and thumb screw permit fast and positive adjustment.

Order #	Description	1+
21-1128	Divider with 3 inch legs	\$75.00

**SPRING DIVIDER**

Features heavy-duty, spring action with a special, quick-adjustment nut. The perfect tool for measuring distances between points and scribing circles and arcs. Made in Germany.

Order #	Max Opening	Leg Length	1+
35-0800	2¼"	3"	\$14.35
35-0802	6½"	6"	\$15.50

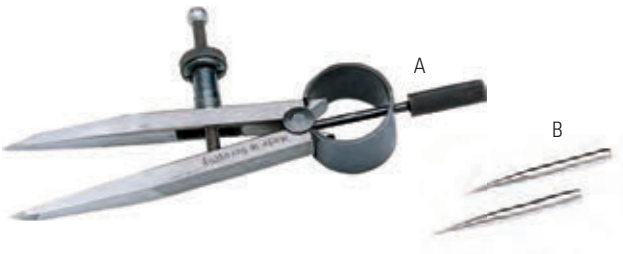
**SPRING DIVIDER WITH ADJUSTABLE POINTS**

Sharp, pointed tips are adjustable and can be replaced. Maximum opening 2¾" with tips retracted or ¾" with tips extended. Special quick-adjustment nut and heavy-duty spring. Made in Germany.

Item	Order #	Description	1+
A	35-0805	Spring Divider	\$14.35
B	35-0806	Replacement Tips (sold per pair)	\$2.65

**KERR® CALIPER**

Stainless steel and calibrated in 0.1mm. Excellent for measuring wall thicknesses. Rounded tip caliper is perfect for wax carving. The pointed tip is perfect for metal work.

Order #	Description	1+
21-0025	Round Tip Caliper	\$37.50

STEPPED WAX RING MANDREL

Round stepped sizes 4-13. Rotates 360° vertically. Aluminum mandrel is highly polished for easy wax removal. Sturdy steel base.

Order #	Description	Length	1+
21-0896	Stepped Wax Ring Mandrel	13"	\$21.50

**MAX WAX PENS**

Cordless wax tools used to form beads and details, whisk away flares, and spray and repair floaters and accidents. Designed to transfer wax to models. Heats up instantly to 850° with finger pressure control. Batteries included.

Item	Order #	Description	Length	Batteries	1+
A	21-2600	Max Wax Pen	6¾"	1- AA	\$25.00
B	21-2602	Super Max Wax Pen	8½"	2- AA	\$27.50
C	21-2601	Replacement Tips			\$6.50

**WAX PEN**

This digital touch-sensitive unit is used for wax working and spruing. Innovative touch power allows precise control of temperature when you touch the contact point on the pen. It has an immediate heating response. Low enough temperatures for precision wax working, yet high enough to burn silicon mold. Very small footprint takes up less space on the bench. Includes 4 Nichrome tips.

Order #	Description	1+
21-2003	Touch-A-Matic Wax Pen	\$270.00
21-2002	Set of 9 Tips	\$85.00

**ECONO WAXER WITH PEN**

This compact and economical 2 amp waxer quickly heats up to 350°F. This unit has an easy to read dial and a small handle designed to stay cool with a soft rubber finger rest. Each kit comes with 6 tips which can all be customized with a file or pair of pliers. This pen can even be mounted on a wall to save space (Velcro® not included).

Item	Order #	Description	12+	6+	1+
D	21-2604	Econo Waxer with Pen	\$118.15	\$125.10	\$139.00



Find added video content on Stuller.com.

GILES WAXER

This unit is excellent for carving, shaping, and texturing wax models. Comes with three tips and nine settings. Has a flexible handle for delicate work. Unit is 115V.

Item	Order #	Description	1+
E	21-0080	Waxer with 3 Tips	\$170.00
	21-0081	Replacement Tip (Red)	\$14.30
	21-0082	Replacement Tip (Blue)	\$14.75
	21-0083	Replacement Tip (Yellow)	\$14.30
	21-0084	Replacement Handle	\$74.65
F	21-0052	Super Heavy Duty 220 Unit (no tips)	\$598.00
	21-0053	Handle for Heavy Duty Waxer	\$119.95
	21-0087	Special Tip for Heavy Duty Waxer (not shown)	\$38.95



Casting



Find added video content on Stuller.com.

KERR® ULTRA-WAXER 2

An electronic waxing unit designed to increase efficiency and quality of waxing applications. - Includes dual spatulas to optimize productivity and an all-aluminum, lightweight design, which helps increase user comfort. - Foam grips on the spatula allow technicians to change the tips while they are still hot. - A convenient tip holder that keeps eight interchangeable heating tips organized and easily accessible. - Easy-to-use operations such as programmable presets and a quick heat function to increase unit effectiveness. - Tips from your Ultra-Waxer will fit the Ultra-Waxer 2. - 100°F-500°F

Item	Order #	Description	1+
A	22-0085	Kerr® Ultra-Waxer 2	\$375.00
B	22-0088	Spatula Small Blue Tip	\$79.00
C	22-0089	Spatula Large Teal Tip	\$79.00
D	22-0090	Spatula Beavertail Purple Tip	\$79.00
E	22-0091	Spatula Small # 7 Gray Tip	\$79.00
F	22-0092	Spatula Large # 7 Green Tip	\$79.00
G	22-0093	Spatula Needle Red Tip	\$79.00
H	22-0094	Spatula ½ Hollenback Black Tip	\$79.00
J	22-0095	Spatula Small Denture Pink Tip	\$79.00
K	22-0096	Spatula Large Denture Orange Tip	\$79.00
L	22-0097	Spatula Denture Spoon Yellow Tip	\$79.00
M	22-0133	Spatula Cord/Handle	\$79.00



Three tips included.

FOREDOM® WAX CARVER

The Handpiece – Lightweight and comfortable to hold with cork insulation to keep fingertips cool while working.

Compact Control – Precision heat control dial for setting and maintaining temperatures from 95°F (35°C) up to 560°F (294°C). Only 2½" x 2" (64 x 51mm). It hardly takes up any workbench space. 115V.

Brass Tips – Easy to clean and change, they're a great improvement over the tips used on other models. You can alter the tips with a file or pliers and create your own custom shapes. The wax carver comes with three tips: knife, small spoon, and straight taper. Four optional tips are sold separately. (*One-year limited manufacturer's warranty on all components except tips.)

Item	Order #	Description	1+
N	21-0180	Wax Carver	\$195.00
P	21-0183	Knife Tip	\$12.45
Q	21-0184	Small Spoon Tip	\$12.45
R	21-0186	Straight Taper Tip	\$12.45
S	21-0187	Curved Taper Tip	\$12.45
T	21-0188	Small Flat Tip	\$12.45
U	21-0189	Large Flat Tip	\$12.45

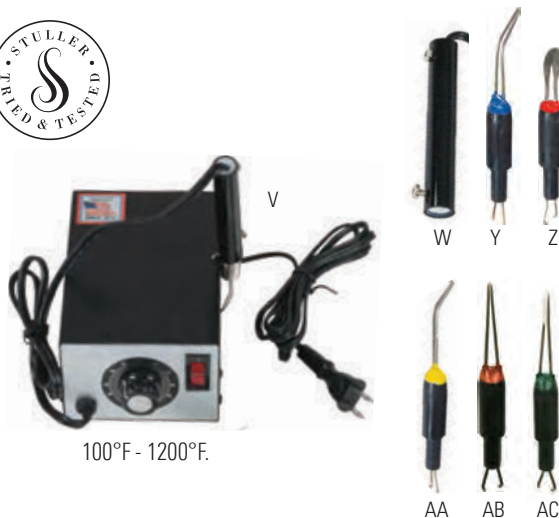
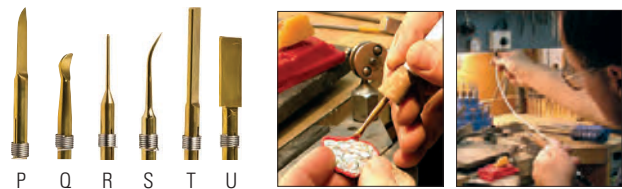

100°F - 1200°F.

PRECISION WAX HEATING UNIT

Heavy duty variable power rheostat enables precise and consistent temperature control. Sturdy handle with ultra flexible cord provides comfortable use. Built-in holder provides a safe place to store handpiece when not in use.

Item	Order #	Description	W x D x H	1+
V	47-4160	Heating Unit with Tip	4" x 6" x 3"	\$145.00
W	47-4161	Handpiece		\$45.00
Y	47-4162	Tip (Blue)		\$12.00
Z	47-4163	Tip (Red)		\$12.00
AA	47-4164	Tip (Yellow)		\$11.40
AB	47-4165	Tip (Orange)		\$11.40
AC	47-4166	Tip (Green)		\$12.00

**GRIFFITH WAXOLVENT**

A quality solvent and polish for wax and plastic models. Hazardous material, ships UPS Ground only.



Item	Order #	Description	Capacity	12+	6+	1+
A	54-9010	Bottle	4 oz	\$6.12	\$6.38	\$6.65
B	54-9012	Bottle	8 oz	\$10.12	\$10.56	\$11.00

KERR® LABORATORY SOLITINE™

For cleaning and smoothing waxes. Excellent for removing scratches, parting lines, or other imperfections. Produces a highly polished surface. Spray applicator included. Ships UPS Ground only.



Order #	Capacity	12+	6+	1+
21-0210	8 oz	\$30.04	\$31.34	\$32.65

PRO-CRAFT® VAC-U-COAT/DEBUBBLER

Reduces surface tension on model so that investment will adhere. Eliminates bubbles.



Order #	Capacity	12+	6+	1+
54-4427	7½ oz	\$5.20	\$5.42	\$5.65

**GLASS ALCOHOL LAMPS**

E-F. Nickel-plated brass burner with screw adjustment for wick. Includes 3" wick, 3/16" diameter.

G. Polished chrome-plated base with screw adjustment for wick. Includes 3" wick, 3/16" diameter.

Item	Order #	W x H	Capacity	12+	6+	1+
E	54-8025	2½" x 1"	1½ oz	\$8.09	\$8.78	\$9.75
F	54-8026	2½" x 1¾"	3 oz	\$8.29	\$8.78	\$9.75
G	14-2865	3" x 3"	3 oz	\$17.25	\$18.00	\$18.75
	54-8027	Replacement Wicks 3/16" (pack of 12)		\$3.65	\$3.96	\$4.40

**WAX KLEEN**

A non-petroleum, pleasant, citrus-scented solution for removing light scratches, parting lines, and polishing wax patterns. Also excellent for removing "stuck on" price or stock number labels without marring product surface. Ships UPS Ground only.

Item	Order #	Description	Capacity	12+	6+	1+
C	21-0160	Wax Gloss	4 oz	\$8.60	\$8.98	\$9.35
D	21-0162	Wax Gloss	8 oz	\$15.00	\$15.65	\$16.30

MICRO WAX FILM DEBUBBLER

Applied to wax patterns before vacuum investing to prevent wax bubbles. Non-flammable and biodegradable.



Order #	Capacity	12+	6+	1+
54-4445	1 gallon	\$18.61	\$19.71	\$21.90

DENATURED ALCOHOL

For use in alcohol lamps, making anti-oxidizers, and as a quick-drying dip to prevent spotting of plated pieces. Flammable, ships UPS Ground only.



Order #	Capacity	12+	6+	1+
54-8041	16 oz Bottle	\$6.53	\$6.82	\$7.10
54-8042	32 oz Bottle	\$8.46	\$8.83	\$9.20

**SOLVENT DISPENSER**

These dispensers have no stopper or cap to remove. Just touch the dispensing dish with a brush, cloth, or other applicator and the solvent is brought to the surface the instant it is needed. Stainless steel valves seal contents in the bottle until used, preventing spills, dripping, and escaping fumes. Fluid pumped into the dish does not drip back into the bottle, keeping stored liquids uncontaminated. Made of static dissipative plastic with Teflon tube.

Item	Order #	Description	Capacity	12+	6+	1+
J	54-4036	Small	4 oz (120ml)	\$16.01	\$16.70	\$17.40
K	54-4037	Small Anti-Splash	4 oz (120ml)	\$16.51	\$17.23	\$17.95
L	54-4038	Large	6 oz (180ml)	\$16.01	\$16.70	\$17.40

Casting

**CASTALDO® MOLD RUBBER****Castaldo® Gold Label®:**

- Premium soft
- Very pliable
- Great for molds containing undercuts

Castaldo® White Label®:

- Regular Firm
- Resilient
- Pliable
- Great for pieces that do not require undercuts like flat items

Castaldo® No Shrink Pink®:

- Provides zero shrinkage
- Excellent detail
- Vulcanized at 310°F for 7½ minutes per layer.



Item	Order #	Description	W × L × Thickness	12+	6+	1+
A	22-5865	Gold Label Strips	2⅞" × 18" × ⅛"	\$44.90	\$46.85	\$48.80
B	22-5855	White Label Strips	2⅞" × 18" × ⅛"	\$42.96	\$44.83	\$46.70
C	22-5885	No-Shrink Pink Strips	2⅞" × 18" × ⅛"	\$49.27	\$51.41	\$53.55
D	22-5860	Gold Label Ready-Cut	2⅞" × 17⅞" × ⅛"	\$47.38	\$49.44	\$51.50
E	22-5850	White Label Ready-Cut	2⅞" × 17⅞" × ⅛"	\$43.98	\$45.89	\$47.80
F	22-5880	No-Shrink Pink Ready-Cut	2⅞" × 17⅞" × ⅛"	\$52.72	\$55.01	\$57.30

**CASTALDO® TITANIUM LABEL™ MOLD RUBBER****Castaldo® Titanium Features:**

- Less pattern distortion
- Higher injection pressures
- Reduced rubber shrinkage
- Lower injection temperatures
- Higher clamping pressure
- Better detail
- Vulcanized at 307°



Order #	Description	W × L × Thickness	12+	6+	1+
22-5916	Titanium Label	2⅞" × 18" × ⅛"	\$48.81	\$50.93	\$53.05

**CASTALDO® SUPER STRETCH SILICONE MOLDING RUBBER**

New SuperStretch offers fantastic tear strength that allows mold makers to make standard two- part molds of designs that formerly required complicated multi-piece molds with difficult cores and inserts. The rubber stretches 900% before breaking. SuperStretch is easy to pack, easy to cut, and requires no silicone mold release spray. The shine is fantastic with waxes coming out with a glossy high shine finish meaning castings will require less finishing. Rubber shrinkage is very low at only 1.3%.



Order #	Description	W × L × Thickness	12+	6+	1+
22-5856	Super Stretch	2⅞" × 18" × ⅛"	\$44.90	\$46.85	\$48.80

**ECONOSIL ORANGE SILICONE RUBBER**

Silicone molding rubbers are synthetic rubber compounds. They have the consistency of molding clay, which reduces packing time to a few minutes. No spray needed. The rubber is orange in color. Vulcanize at 330°F for 15 minutes per layer.



Order #	Description	W × L × Thickness	12+	6+	1+
22-5900	Silicone Mold Rubber	2⅞" × 18" × ⅛"	\$44.90	\$46.85	\$48.80

CASTALDO® GELATO™

Castaldo® super high strength silicone molding rubber cuts like butter. It resists tearing and is strong enough to make complex molds that are stronger than any other silicone molding rubber on the market. The different colors do not have different properties. Rather, they allow the jeweler to color code his/her molds for categorizing.

- Easy to cut - No mold release spray
- High shine finish - Cheaper and easier than RTVs
- Vulcanize at 330°F for 15 minutes per layer
- Width x Length x Thickness: 27/8" x 18" x 1/8"



Item	Order #	W x L x Thickness	Color	12+	6+	1+
	22-5908	Assortment - 7 colors		\$43.88	\$45.79	\$47.70
A	22-5901	27/8" x 18" x 1/8"	Blue	\$43.88	\$45.79	\$47.70
B	22-5902	27/8" x 18" x 1/8"	Peach	\$43.88	\$45.79	\$47.70
C	22-5903	27/8" x 18" x 1/8"	Lemon	\$43.88	\$45.79	\$47.70
D	22-5904	27/8" x 18" x 1/8"	Fuchsia	\$43.88	\$45.79	\$47.70
E	22-5905	27/8" x 18" x 1/8"	Pistachio	\$43.88	\$45.79	\$47.70
F	22-5906	27/8" x 18" x 1/8"	Violet	\$43.88	\$45.79	\$47.70
G	22-5907	27/8" x 18" x 1/8"	Tan	\$44.90	\$46.85	\$48.80

**VLT SILICONE RUBBER**

Castaldo® VLT (very low temperature) make high volume molds directly from CAD/CAM and rapid prototyping models fast without risk of damage from heat or pressure. Get your models into production in as little as 30 minutes. Castaldo® VLT vulcanizes at temps as low as 150°F. Makes great molds from traditional wax carvings. Also, spray wax or plastic model with release spray to ensure easy release of the model after vulcanization. Shrinkage is only 1.4%. Castaldo® Silicone Modeling Rubber can be vulcanized in a wide range of time and temperature combinations depending on the characteristics of your model material.



Order #	Description	W x L x Thickness	12+	6+	1+
22-5915	Silicone Rubber	27/8" x 18" x 1/8"	\$41.48	\$43.92	\$48.80

**CASTALDO® LIQUAGLASS KIT**

Castaldo® LiquaGlass™ 0% shrinkage clear liquid RTV jewelry molding rubber makes strong, tough, flexible production molds at only a fraction of the price of clear silicone rubbers. Easy to measure, easy to mix, easy to pour, and easy to vacuum or de-bubble, LiquaGlass cures at room temperature in 24 hours with 0% shrinkage. Castaldo® LiquaGlass™ is packaged in a 1kg/2.2lb. kit containing equal parts A and B. 1:1 Mix Ratio. Cure time: 16 hours.

Order #	Description	12+	6+	1+
22-5869	2-Part RVT Rubber Kit	\$58.99	\$62.46	\$69.40

**CASTALDO® LIQUACAST LONG LIFE RTV LIQUID MOLDING RUBBER**

New 0% shrinkage liquid RTV rubber with all the advantages of regular Castaldo® LiquaCast™ plus added strength, tear resistance, and firmness. Its extreme durability means that difficult molds last and are less likely to break or tear in use. Bright orange in color and is packaged in plastic containers in two-part kits weighing 1kg, 8kg, and 20kg. Cure time: 24 hours.

Order #	Description	Size	1+
22-5896	LiquaCast Molding Rubber	2.2 lb	\$180.30
22-5896	LiquaCast Molding Rubber	17.6 lb	\$68.90



Casting

**CASTALDO® LIQUACAST™ AND CASTALDO® QUICK-SIL™ KITS**

A. Castaldeo® LiquaCast™ makes stronger, tougher, and longer-lasting production molds than other RTVs. LiquaCast is easier to mix, easier to vacuum or debubble, and easier to pour. It's safe, easy to use, and produces the finest details. Instructions included. 10:1 mix ratio. Cure time: 18 hours.

B. Castaldeo® Quick-Sil™ is a revolutionary 0% shrinkage jewelry molding rubber material that makes tough, long-lasting production molds with a high shine. Instructions included. Cure time: 15 minutes.

Item	Order #	Description	Size	12+	6+	1+
A	22-5870	2-Part LiquaCast Kit	1 lb	\$36.62	\$38.21	\$39.80
	22-5870	2-Part LiquaCast Kit	10 lb	—	—	\$99.80
B	22-5871	2-Part Quick-Sil Kit	2.216 lb	\$57.60	\$62.46	\$69.40
	22-5871	2-Part Quick-Sil Kit	11 lb	—	—	\$275.75

**CASTALDO® MOLD-LOCK FORMERS**

Castaldeo® mold-lock formers are a convenient, easy way to make mold locks without cutting. These stamped brass cones will form locks to prevent molds from shifting during injection. Sold by the bag. Each bag contains approximately 150 pieces weighing approximately 3 oz.

Order #	Description	12+	6+	1+
22-5889	Mold Lock Formers	\$15.50	\$16.18	\$16.85

**CASTALDO® MOLD RELEASE CREAM™**

Makes mold separation easier. Mold cream is a lotion and is more effective at separating a mold in half than using knives or powder. Vulcanized molds can be pulled open by hand. Mold cream is safe and non-toxic in plastic containers.

Order #	Description	Size	12+	6+	1+
22-5844	Mold Release Cream	1 oz	\$8.97	\$9.49	\$10.55

**CASTALDO® RESIN RELEASE SPRAY**

This resin release spray is a non-silicone, non- PTFE coating designed to release plastic resin and wax models from jewelry molds. The resin spray is non-flammable, non-explosive, natural, biodegradable, and is worker safe. Each can contains 340 grams.

Item	Order #	Description	12+	6+	1+
C	22-5849	Resin Release Spray	\$12.49	\$13.55	\$15.05

SPIRITS MOLD RELEASE

Allows a clean, smooth release of wax from the rubber mold. Do not use with Ditto products. Hazardous material, ships UPS Ground only.

Item	Order #	Description	12+	6+	1+
D	22-5840	Resin Release Spray	\$16.10	\$16.80	\$17.50

**CASTALDO® JEWELRY-MOLD RELEASE SPRAY**

Safe, non-toxic, long-lasting silicone spray used to prevent wax from sticking to molds, which helps eliminate broken patterns. Works well on rubber molds and metal molds. Spray a small amount onto the mold before injecting wax. Virtually odorless. Material is non-explosive and nonflammable. Contains no CFCs or VOCs. Hazardous material, ships UPS Ground only.

Item	Order #	Description	12+	6+	1+
E	22-5845	Mold Spray Release	\$11.73	\$12.42	\$13.80

FREEMAN JEWEL-SIL KITS

A two-part component, room-temperature vulcanizing silicone rubber compound. Designed especially for mold making, it is an ideal rubber for reproducing intricate detail and maintaining close tolerances. It features low viscosity for easy pouring and excellent clarity and cutting ability. It features high tear strength and the ability to endure temperatures up to 350°F. 1% or less shrinkage rate.

Item	Order #	Description	Size	Color	12+	6+	1+
A	54-5602	2-Part Silicone Rubber	2.2 lb	Clear	\$50.46	\$52.66	\$54.85
B	54-5605	2-Part Silicone Rubber	1 Gallon	Clear	—	—	\$274.80



REPLISIL CLEAR MOLD SILICONE RUBBER KIT

Two A and B component silicone that pours and cures at an ambient temperature without any shrinkage. Available in clear 1.1kg. 9:1 ratio of A to B. Made in Germany.



Order #	Description	12+	6+	1+
22-5811	2-Part - Silicone Mold Rubber	\$68.22	\$71.18	\$74.15



HEAVY DUTY VULCANIZERS

- Heavy duty aluminum cast construction
- Steel frame ceramic-mica heating element
- Ultra sensitive bulb and capillary
- Sensitive thermostat, ensures consistent accurate temperature
- 5/8" thick aluminum heating plates "won't warp"
- Maximum temperature 550°F

Item	Order #	Description	W x L x H	ID	Jaw Size	1+
C	22-7436	Deluxe	15" x 8" x 18"	4"	6" x 8 1/4"	\$925.00
D	22-7435	Standard	14" x 9" x 20"	2 3/4"	5" x 8"	\$669.95

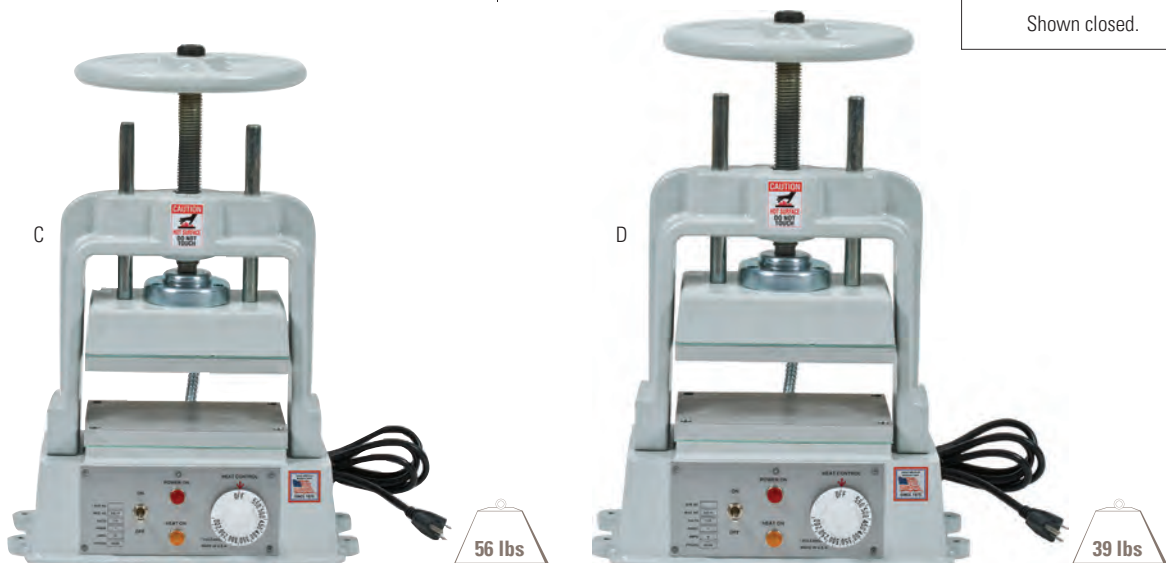

Casting

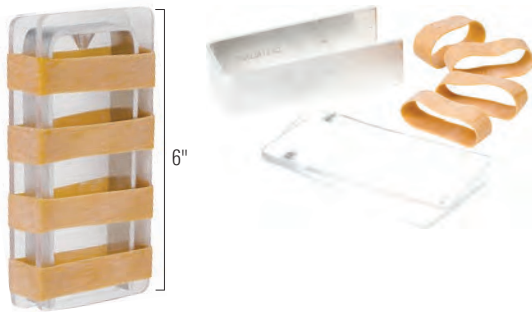

6"

LIQUID MOLD FRAMES

Clear plastic plates release easily from rubber, and won't shatter or cut hands like glass plates. Plastic mold frames can be used with LiguaCast RTV liquid rubber compounds and all other liquid rubber compounds. Heavy duty bands included.

Order #	W x L x Thickness	12+	6+	1+
22-6006	1 $\frac{7}{8}$ " x 6" x 1 $\frac{1}{4}$ "	\$15.00	\$15.89	\$17.65
22-6007	1 $\frac{7}{8}$ " x 6" x 1"	\$15.00	\$15.89	\$17.65
22-6008	1 $\frac{7}{8}$ " x 6" x 1 $\frac{1}{4}$ "	\$15.00	\$15.89	\$17.65
22-6009	1 $\frac{7}{8}$ " x 6" x 1 $\frac{1}{2}$ "	\$15.00	\$15.89	\$17.65

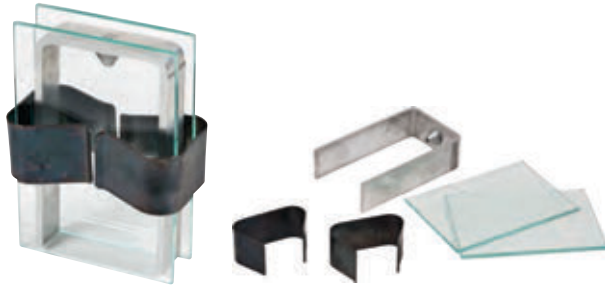
**SEE-THRU® MOLD FRAMES BY FERRIS®**

Features a built-in sprue former, glass cover plates, and corrosion resistant clamps. The perfect frame for pourable mold compounds.

Order #	W x L x Thickness	12+	6+	1+
22-5922	2" x 3" x $\frac{7}{8}$ "	\$17.38	\$18.41	\$20.45
22-5923	2" x 3" x $\frac{3}{4}$ "	\$17.77	\$18.81	\$20.90
22-5924	2" x 3" x 1"	\$22.36	\$23.67	\$26.30
22-5925	2" x 3" x 1 $\frac{1}{4}$ "	\$22.10	\$23.40	\$26.00

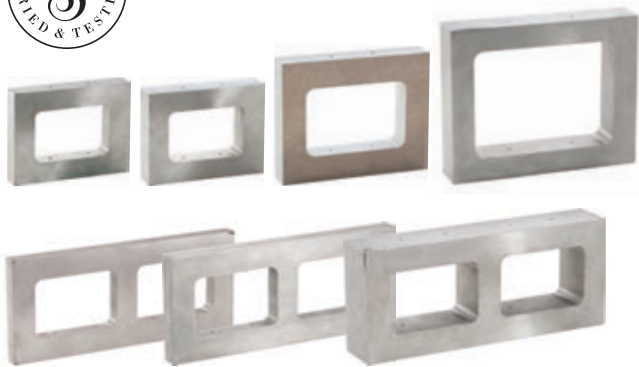
**ALUMINUM MOLD FRAMES**

Used to hold uncured rubber and model when vulcanizing. Sides of frame contain pre-drilled holes to allow excess rubber to escape, preventing model deformation.

Order #	Description	W x L x Thickness	12+	6+	1+
22-5506	Single	2 $\frac{7}{8}$ " x 1 $\frac{7}{8}$ " x $\frac{3}{4}$ "	\$9.35	\$9.90	\$11.00
22-5507	Single	2 $\frac{7}{8}$ " x 1 $\frac{7}{8}$ " x 1"	\$10.58	\$11.21	\$12.45
22-5509	Single	3 $\frac{3}{4}$ " x 2 $\frac{1}{2}$ " x 1"	\$13.56	\$14.36	\$15.95
22-5600	Single	4 $\frac{3}{4}$ " x 3 $\frac{1}{2}$ " x 1 $\frac{1}{4}$ "	\$29.58	\$31.32	\$34.80
22-5620	Double	2 $\frac{7}{8}$ " x 1 $\frac{7}{8}$ " x $\frac{1}{2}$ "	\$11.41	\$11.41	\$11.41
22-5621	Double	2 $\frac{7}{8}$ " x 1 $\frac{7}{8}$ " x $\frac{5}{8}$ "	\$12.65	\$12.65	\$12.65
22-5622	Double	2 $\frac{7}{8}$ " x 1 $\frac{7}{8}$ " x 1 $\frac{1}{2}$ "	\$23.59	\$23.59	\$23.59

**MOLD FRAME PLATES**

Metal plates used when vulcanizing that prevent mold rubber from adhering to the vulcanizer.

Order #	W x L x Thickness	12+	6+	1+
22-5700	5" x 7" x $\frac{1}{8}$ " (set of 2)	\$9.52	\$10.08	\$11.20
22-5701	4" x 6" x $\frac{1}{8}$ " (set of 2)	\$7.52	\$7.97	\$8.85
22-5702	3 $\frac{1}{2}$ " x 5" x $\frac{1}{8}$ " (set of 2)	\$5.87	\$6.21	\$6.90
22-5703	2 $\frac{1}{2}$ " x 3 $\frac{1}{2}$ " x $\frac{1}{8}$ " (set of 2)	\$5.40	\$5.72	\$6.35

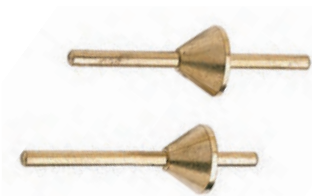
**SPRUE FORMERS**

Used to form an opening in the mold through which wax is injected. Attaches to the model in the mold frame. Also assures proper fit on the nozzle of the wax injector.

Order #	Description	12+	6+	1+
22-5800	Sprue Formers	\$1.06	\$1.10	\$1.15

MOLD-MATE™

Cut molds safely and easily. The new Mold-Mate™ has one vise-like clamp and a plastic cutting surface to help hold the mold. Mold-Mate™ gives cutter free movement of the mold for easier cutting and inspection.

Order #	Description	12+	6+	1+
39-2565	Mold-Mate	\$76.50	\$81.00	\$90.00



SWANN-MORTON® KNIFE BLADES

Swann-Morton® high-carbon knife blades are high-quality, precise (non-sterilized) blades for mold cutting. High carbon is sharper and lasts longer than stainless.

Item	Order #	Description	Per Pack	12+	6+	1+
A	39-2585	#11 Straight	Pack of 5	\$1.62	\$1.71	\$1.90
	39-2580	#11 Straight	Pack of 100	\$22.10	\$23.40	\$26.00
B	39-2595	#12 Curved	Pack of 5	\$1.57	\$1.67	\$1.85
	39-2590	#12 Curved	Pack of 100	\$22.10	\$23.40	\$26.00



MOLD-CUTTING KNIFE HANDLES

Used for #11 and #12 blades. Excellent for cutting rubber molds or wax carvings. Contoured and very comfortable.

Item	Order #	Description	12+	6+	1+
C	39-2560	Steel	\$3.19	\$3.38	\$3.75
D	39-2561	Blue Rubber PVC Grip	\$7.10	\$7.52	\$8.35
E	39-2570	Contoured Plastic	\$5.53	\$5.85	\$6.50
F	39-2575	Hollow Stainless Steel	\$6.12	\$6.48	\$7.20



RETRACTAWAY SCALPEL

The Retractable has a sleek, graphite-finished metal handle, offering the added safety of a hand-retractable blade mechanism. It is a highly versatile cutting tool, produced with designers, graphic artists, and model makers in mind.

Order #	Description	Per Pack	12+	6+	1+
39-2500	Scalpel with 2 Blades		\$12.16	\$12.87	\$14.30
39-2585	#11 Straight	Pack of 5	\$1.62	\$1.71	\$1.90



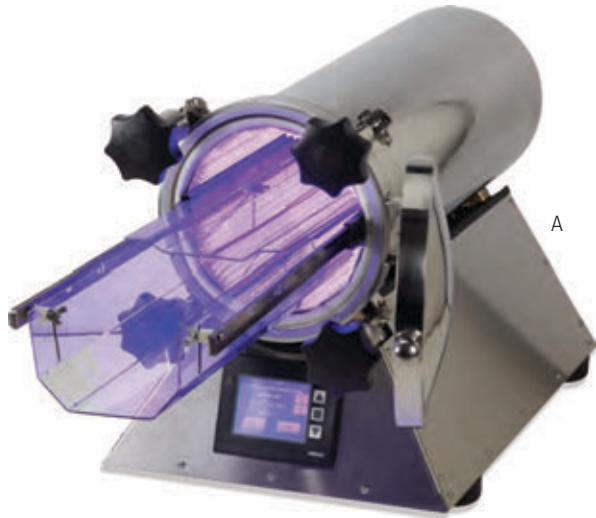

A



B

C

HD EQUIPMENT

A. **The HD Silver Bullet** is a hyperbaric curing chamber for HD Photopolymer Pattern production as well as RTV silicone mold making. This automatic hyperbaric chamber uses alternating air pressure and light energy to produce bubble-free HD precision casting patterns and bubblefree RTV silicone molds.

B. **The HD "Firefly" Kit** produces both silicone RTV molds and HD casting patterns. The Firefly hyperbaric light chamber utilizes air pressure instead of vacuum to eliminate air bubbles often associated with both mold and casting pattern production. Up to six RTV molds can be made in the chamber per cycle, curing in as little as two hours. When making HD casting patterns, up to four molds can be placed in the chamber per cycle with an average curing time of six minutes. Kit includes the hyperbaric light chamber, stainless steel stand, three stainless steel mold frames, timer, power supply, spin bag, and air coupling.

C. **The HD "Novac"** hyperbaric curing chamber utilizes air pressure to remove bubbles in the production of silicone RTV molds. By replacing the vacuum equipment and vacuum steps in mold production, the Novac chamber eliminates the time, waste, and mess normally associated with silicone RTV mold production.

Item	Order #	Description	1+
A	54-5802	HD Silver Bullet	\$9,888.00
B	54-5803	HD Firefly Kit	\$645.00
C	54-5801	HD Novac	\$185.00

HD SPITFIRE INJECTION MACHINE

The HD Spitfire is a low-pressure injector for mold filling of HD liquid polymer formulations. It injects into clear silicone molds in the HD Pattern light curing chambers. The Silver Bullet or Firefly curing chambers complete the production of high detailed and durable polymer patterns for casting. Requiring no electricity, the Spitfire is an air logic system that requires only a source of compressed air for operation. The HD polymer bottles fit easily in the Spitfire's internal dispensing tank. Three manual control valves operate the tank pressure, dispensing nozzle, and auxiliary air port. A foot pedal operates the dispensing nozzle for controlled mold filling of the liquid polymer into the silicone molds. Designed for extremely long life, the sturdy Spitfire has been designed with a very narrow footprint to conserve counter space.



Order #	Description	1+
22-5950	Spitfire Injection Machine	\$3,250.00

HD MOLD FRAME

HD Micro-Frame kits offer an economical alternative to traditional RTV mold frames. The compact frame sizes save approximately half the RTV required for industry standard frames. The precision stainless steel Micro- Frames quickly pay for themselves in RTV savings and are compatible with all RTV compounds. The innovative hinge-forming rod included in each kit allows the finished micro-molds to open and close like a book with perfect registration, eliminating the need for cutting intricate corner keys. A removable stainless steel sprue former and matching thumbscrew allows the master to be mounted in the sprue-former outside the mold frame without frame restriction or wobble. HD stainless steel Micro-Frame kits include two glass plates, rubber bands, sprue former, thumb screw, nylon hinge-forming rod, and nylon sprue-forming rod. The polypropylene jar that houses the kit doubles as a convenient RTV mixing cup.

Order #	Description	Height	1+
22-5926	HD Micro Mold Frame Kit	1/2"/12mm	\$19.65
22-5927	HD Micro Mold Frame Kit	5/8"/16mm	\$20.70
22-5928	HD Micro Mold Frame Kit	3/4"/20mm	\$21.75
22-5929	HD Micro Mold Frame Kit	1"/25mm	\$22.80
22-5930	HD Micro Mold Frame Kit	1 1/4"/31mm	\$23.80



HD AVATAR

Avatar is the newest addition to the HD Pattern System product line. Designed to produce heavier patterns in the class ring range for casting, this new photopolymer can also produce ultra light patterns as well. This virtual non-shrink polymer allows precise duplication from masters molded in clear RTV silicone. All HD patterns offer reliable detail and exact weights for casting. Patterns have perfect memory and infinite shelf life. A needed partner to CAD generated designs, HD patterns succeed where wax injection fails. One small bottle produces patterns that will yield up to 1,500 grams of 14 Karat gold castings.

Order #	Description	Size	1+
22-5940	Avatar	118ml	\$159.15



Designed to produce heavier patterns in the class ring range for casting, this new photopolymer can also produce ultra light patterns as well.



HD MASTER COPY

HD Master Copy is photopolymer that cures to a very tough and hard plastic that can be detailed and/or duplicated to produce a moldable master pattern. It's heat resistance allows it to be used as an alternate to the traditional silver masters for press molding with many vulcanized rubber molding materials, or as a master that can be used with silicone RTV molding compounds.

-Detailing: Milled, injected, or hand carved waxes, as well as RP patterns, or metal masters, can be molded first in clear silicone RTV and a duplicate pattern can then be made with Master Copy. Once the Master Copy pattern is removed from the mold it can be post cured to achieve maximum hardness with the curing lights of the Silver Bullet or Firefly units or in strong sunlight. This first generation Master Copy can be detailed as if it were a metal casting with rotary tools, files, fine abrasives, engravers, and polished to produce a perfect finished master to be molded again. Minimal shrinkage will be present in the duplicate master and it can be saved and reused like a Silver Master to produce additional production molds.

Order #	Description	Size	1+
22-5941	HD Master Copy	118ml	\$159.15



Note: Before molding a Master Copy model, clean the model in soapy water. Post curing or mold release maybe required before the model is used with some molding compounds.

Casting



STULLER MINI WAX INJECTOR

Easy-to-use, economical, hand-operated pump injects wax into mold. Thermostatically controlled settings keep wax at desired temperatures. Low temperature = 125°F, Medium temperature = 150°F, and High temperature = 175°F. Available in 120V. One-year limited manufacturer's warranty. Made in the USA.

Order #	Description	W x H	Wax Capacity	1+
22-7425	1 Pint	8" x 10"	1 lb	\$228.75



STULLER COMPACT AIR PRESSURE WAX INJECTOR

The Stuller compact, air pressure wax injector is constructed to provide years of service-free performance. One-quart, heavy-duty aluminum pot; three wing nuts for easy cover removal and wax loading; 0-20 PSI air pressure regulator and gauge; leak-resistant nozzle (will not clog at injection temperature; accurate thermostat; on/off; safety valve (set at 20 PSI). Requires 6 to 8 PSI (air supply not included). One-year limited manufacturer's warranty. Made in the USA.

Item	Order #	Description	W x H	Wax Capacity	1+
A	22-7424	1 Quart Compact Wax Injector	6" x 12"	2½ lb	\$365.00
REPLACEMENT PARTS					
B	22-7440	Complete Regulator Assembly			\$84.65
C	22-7428	Lid Seal (6¼" diameter)			\$11.40
D	22-7426	Heating Element, 120V			\$58.25
E	22-7403	Nozzle Assembly			\$87.95
	22-7427	Thermostat			\$41.30



STULLER COMPACT AIR PRESSURE WAX INJECTOR

The Stuller compact, air pressure wax injector is constructed to provide years of service-free performance. One-quart, heavy-duty aluminum pot; three wing nuts for easy cover removal and wax loading; 0-20 PSI air pressure regulator and gauge; leak-resistant nozzle (will not clog at injection temperature; accurate thermostat; on/off; safety valve (set at 20 PSI). Requires 6 to 8 PSI (air supply not included). One-year limited manufacturer's warranty. Made in the USA.

Item	Order #	Description	W x H	Wax Capacity	1+
F	22-7432	2¾ Quart Wax Injector	9" x 16"	5½ lb	\$470.00
REPLACEMENT PARTS					
H	22-7440	Complete Regulator Assembly			\$84.65
J	22-7437	Lid Seal (6¼" diameter)			\$11.20
K	22-7439	Heating Element, 120V			\$90.60
L	22-7403	Nozzle Assembly			\$87.95
M	22-7431	Thermometer			\$27.80
N	22-7438	Thermostat			\$91.35



INJECTION WAX FLAKES

Freeman injection wax has been the industry standard for quality and consistency. Our formulations are renowned for their high pattern detail, rapid wax solidification, minimal shrinkage, excellent flow, and low ash content (0.003%), enabling the cleanest burnouts and most accurate reproductions possible. All are designed for platinum, gold and silver, as well as industrial and dental alloys.

AQUA FLAKES

This all-purpose injection wax is our most popular formulation as it provides the ideal balance of characteristics demanded by most designers and casters. Also recommended for stone in place casting.

Order #	Injection Temperature	12+	6+	1+
21-0400	150°F (65°C)	\$6.81	\$7.38	\$8.20

RUBY RED FLAKES

Similar to our Aqua Flakes, except for the deep red color. Many designers and casters prefer the darker color for easier visual verification of fine detail.

Order #	Injection Temperature	12+	6+	1+
21-0401	150°F (65°C)	\$6.81	\$7.38	\$8.20

TURQUOISE FLAKES

Similar to our Aqua Flakes, except for the turquoise color. Many designers and casters prefer the darker color for easier visual verification of fine detail.

Order #	Injection Temperature	12+	6+	1+
21-0402	150°F (65°C)	\$6.81	\$7.38	\$8.20

FILIGREE PINK FLAKES

This wax combines the flexibility of Tuffy Green with the excellent flow characteristics of Aqua Flakes, producing very high detail while enabling easy pattern removal without breakage. Recommended for stone in place casting.

Order #	Injection Temperature	12+	6+	1+
21-0403	155°F (68°C)	\$6.81	\$7.38	\$8.20

FLEXIBLE BLUE FLAKES

Featuring the longest shelf-life and highest flexibility of the Freeman Flakes line, this unique mixture of wax and plastic is especially well-suited for metal molds and stone in place casting.

Order #	Injection Temperature	12+	6+	1+
21-0410	155°F (68°C)	\$6.97	\$7.38	\$8.20

CARVEABLE PURPLE FLAKES

This new wax features low shrinkage, excellent flow, and low ash content, yet offers minimal gumming of wax files and rotary tools like that of traditional injection waxes. It is a durable wax that will not break under stress, and does not react to body heat from fingers while handling. Ideal for designers or any casters who find themselves often reworking wax patterns.

Order #	Injection Temperature	12+	6+	1+
21-0016	170°F (77°C)	\$6.97	\$7.38	\$8.20

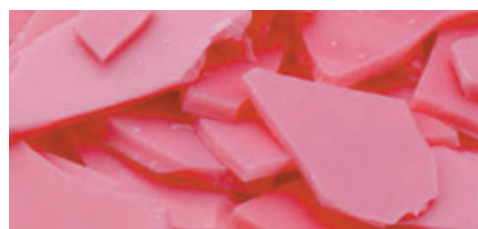

	Flow	Flexibility	Carvability	Shrinkage	Memory	Pattern Shelf Life	Readability	Solidification Time
Aqua	High	Medium	Low	Low	Medium	High	High	Medium
Ruby Red	High	Medium	Low	Low	Medium	High	High	Medium
Turquoise	High	Medium	Low	Low	Medium	High	High	Medium
Filigree Pink	Medium	Medium	Low	Low	Medium	High	Medium	Medium
Filigree Blue	Medium	Highest	Medium	Medium	High	Highest	Medium	Medium
Carveable Purple	High	High	High	Low	Medium	High	High	Fast

Casting

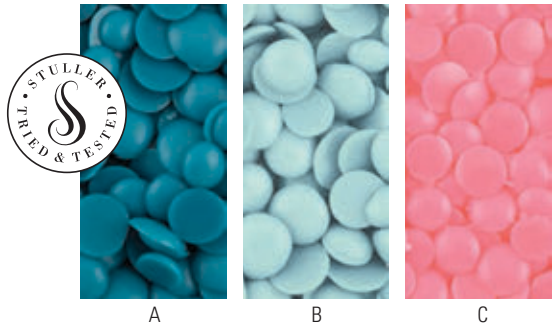

BEAD INJECTION WAXES BY FERRIS®

Excellent flow and high flexibility. This tough wax yields bright surfaces and will not become brittle in storage. Contains a built-in release agent. Turquoise beads with the same durability as aqua, but the darker color increases pattern readability. Injection temperature: 160°-165°F (71°-74°C).

Item	Order #	Description	12+	6+	1+
A	21-0422	Turquoise-Ject Wax Beads	\$6.02	\$6.53	\$7.25
B	21-0421	Aqua-Ject Wax Beads	\$7.47	\$8.10	\$9.00
C	21-0420	Pink Magna-Ject Wax Beads	\$7.47	\$8.10	\$9.00



CASTALDO® PLAST-O-WAX JEWELRY INJECTION WAX

- Produces patterns that are very flexible, resilient, and durable with great memory
- Patterns will not break despite rough handling
- Patterns bend, flex, and twist under pressure but return to their original shape
- Excellent flow and fill characteristics of wax and the stability of plastic
- Wax does not become brittle over time, inject them now – use them months later
- Wax releases easily from any type of mold to produce patterns with smooth glossy surfaces, crisp detail, and minimal shrinkage
- Unlike plastic-only pattern materials, it can easily be steam de-waxed
- Injection temperature 155°-160°F (68°-71°C)

Order #	Description	12+	6+	1+
21-0429	Injection Wax	\$23.42	\$24.80	\$27.55



CASTALDO® SUPERCERA® GOLD

Superior quality wax for a full range of applications in a unique, new form that provides extra convenience with easy identification. The Supercera® Gold is a hard wax with very little flexibility. Flows easily and will hold sharp detail. Almost no shrinkage or shrink. Can be carved. Recommended for large patterns with fine detail. Good for metal molds. Inject at 70°F (76°C).

Order #	Description	12+	6+	1+
21-0460	Supercera® Gold	\$45.86	\$47.86	\$49.95



STULLER SELECT WATER SOLUBLE WAX

Water soluble wax offers jewelry designers an effective, cost-efficient means for creating soluble cores in wax patterns. When injected or poured into the core mold, this wax will conform precisely to the core shape. This hard wax is excellent for precision molds and larger parts. Can be injected or hand cast at 150°F (66°-77°C).

Order #	Description	Size	12+	6+	1+
21-0240	Wax Cake	1 lb box	\$12.07	\$12.78	\$14.20

STULLER SELECT WAX SPRUE RODS

The ideal wax for sprue rods. Fully refined to eliminate impurities, the rods burn out quickly without expansion or residue. Perfect for building even the most demanding sprue systems. The sprue rod of choice for Stuller's own manufacturing. Light Green: A medium hard spruce rod which is tough and rigid. Perfect for general purpose casting. -Melt 158°-168°F

Order #	Diameter	Length	Per Unit	12+	6+	1+
21-1330	¼"	10"	1 lb pack	\$11.68	\$12.19	\$12.70
21-1331	⅜"	10"	1 lb pack	\$11.68	\$12.19	\$12.70
21-1332	½"	10"	1 lb pack	\$12.65	\$13.20	\$13.75
21-1338	⅜"	10"	25 lb box	\$425.96	\$444.48	\$463.00
21-1339	⅜"	6"	25 lb box			\$436.80

**SPRUE WAX**

Combines flexibility and sufficient rigidity for sprues and mounting wax patterns. Melts at lower temperature (125°F) and burns out clean. Great for general sprues and creating runners.

Order #	Gauge	Length	Per Unit	12+	6+	1+
21-1305	6 Gauge	4"	2 oz box	\$9.09	\$9.86	\$10.95
21-1306	8 Gauge	4"	2 oz box	\$9.09	\$9.86	\$10.95
21-1307	10 Gauge	4"	2 oz box	\$9.09	\$9.86	\$10.95
21-1308	12 Gauge	4"	2 oz box	\$9.09	\$9.86	\$10.95

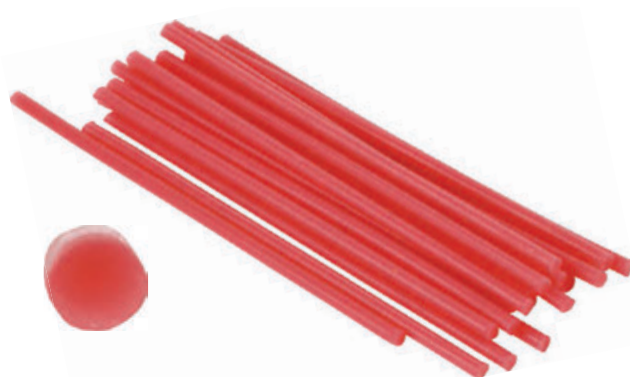
**HEXAGON SPRUE WAX**

Six-sided wax rods make treeing for production casting faster and easier than traditional round sprue rods. Melting temperature 125°F. Burns out fast and clean.

Order #	Diameter	Length	Per Unit	12+	6+	1+
21-1383	⅜"	24"	1 lb pack	\$5.31	\$5.63	\$6.25

**EXTRUDED SPRUE WAX**

Round, petroleum-based "red wax" rods (24" lengths) for sprues. Melting temperature 125°F. Burns out quickly and cleanly.

Order #	Diameter	Length	Per Unit	12+	6+	1+
21-0395	¼"	24"	1 lb pack	\$15.50	\$16.18	\$16.85
21-0396	⅜"	24"	1 lb pack	\$16.51	\$17.23	\$17.95



Casting



KERR FLASKS

Heavy duty, 304 stainless steel flasks with 18 gauge wall thickness.

Item	Order #	Description	OD	Height	12+	6+	1+
A	22-4720	2C	1¾"	1½"	\$15.50	\$16.18	\$16.85
B	22-4719	J3	3½"	2½"	\$16.51	\$17.23	\$17.95

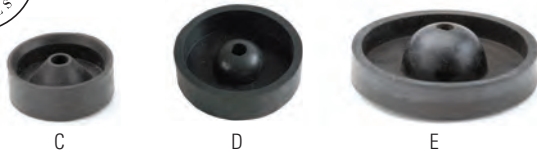

SPRUE BASE

Will accept 3/8" or 1/4" sprue rods.

Item	Order #	Description	OD	12+	6+	1+
C	22-4725	T2	1¾"	\$9.29	\$9.70	\$10.10
D	22-4729	T3	2½"	\$10.35	\$10.80	\$11.25
E	22-4727	Sprue Base (4.35 lb)	3¾"	\$4.19	\$4.37	\$4.55

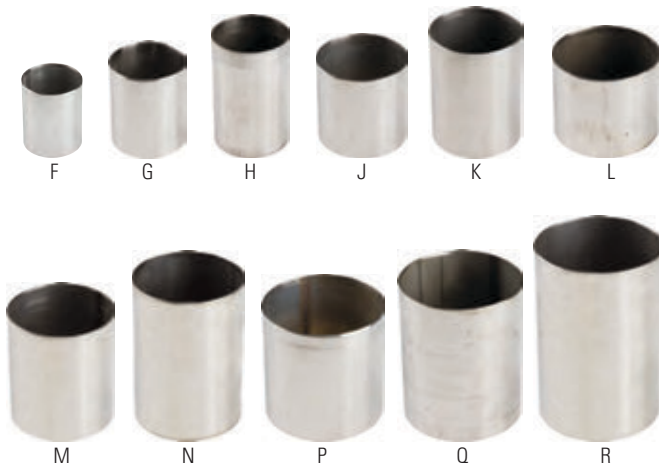

CASTING FLASKS

Made of durable stainless steel. Withstands extreme temperatures, quenching, and burnouts. 18 gauge.

Item	Order #	OD	Height	12+	6+	1+
F	21-6925	2"	2½"	\$4.14	\$4.32	\$4.50
G	21-6930	2½"	3"	\$5.20	\$5.42	\$5.65
H	21-6935	2½"	4"	\$5.89	\$6.14	\$6.40
J	21-6940	3"	3"	\$6.12	\$6.38	\$6.65
K	21-6945	3"	4"	\$6.53	\$6.82	\$7.10
L	21-6950	3½"	3"	\$7.77	\$8.11	\$8.45
M	21-6955	3½"	4"	\$4.85	\$4.85	\$4.85
N	21-6960	3½"	5"	\$10.35	\$10.80	\$11.25
P	21-6965	4"	4"	\$10.35	\$10.80	\$11.25
Q	21-6966	4"	5"	\$9.82	\$10.40	\$11.55
R	21-6970	4"	6"	\$11.73	\$12.24	\$12.75

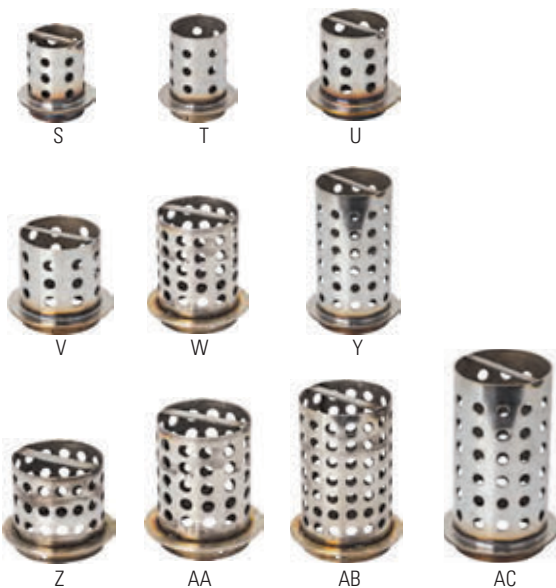

PERFORATED FLASKS

Stainless steel flasks used in vacuum casting. A vacuum pulls through the end and side, which allows complete fills. Masking tape is used to cover the holes when investing.

Item	Order #	OD	Height	12+	6+	1+
S	21-7000	2½"	3½"	\$17.13	\$18.14	\$20.15
T	21-7001	2½"	4"	\$21.68	\$22.95	\$25.50
U	21-7002	3"	4"	\$25.37	\$26.87	\$29.85
V	21-7011	3½"	4"	\$25.16	\$26.64	\$29.60
W	21-7012	3½"	5"	\$29.50	\$31.23	\$34.70
Y	21-7013	3½"	6"	\$31.58	\$33.44	\$37.15
Z	21-7003	4"	4"	\$33.90	\$35.38	\$36.85
AA	21-7014	4"	6"	\$33.62	\$35.60	\$39.55
AB	21-7007	4"	7"	\$39.65	\$41.38	\$43.10
AC	21-7015	4"	8"	\$41.86	\$44.33	\$49.25

**SPRUE BASE**

Allows the tree rod to be placed directly in the base and held securely.
Will accept 3/8" or 1/4" sprue rods.

Item	Order #	OD	12+	6+	1+
A	21-7834	2"	\$2.67	\$2.78	\$2.90
B	21-7835	2½"	\$2.85	\$2.98	\$3.10
C	21-7836	3"	\$3.08	\$3.22	\$3.35
D	21-7832	3½"	\$3.54	\$3.70	\$3.85
E	21-7833	4"	\$3.82	\$3.98	\$4.15

**BUTTON SPRUE BASE**

Used to form the base for the sprue. Fill the cup in the center with wax or clay and attach wax with sticky wax.

Item	Order #	OD	12+	6+	1+
F	21-7827	2"	\$2.90	\$3.02	\$3.15
G	21-7828	2½"	\$2.94	\$3.07	\$3.20
H	21-7829	3"	\$3.17	\$3.31	\$3.45
J	21-7830	3½"	\$3.13	\$3.26	\$3.40
K	21-7831	4"	\$4.23	\$4.42	\$4.60

**FLASK EXTENDERS**

Used to prevent overflow of investment during vacuuming. Made of rubber. Easily slips on and off flasks.

Item	Order #	OD	Height	12+	6+	1+
L	21-7970	2½"	3"	\$8.56	\$8.93	\$9.30
M	21-7975	3"	3"	\$8.56	\$8.93	\$9.30
N	21-7980	3½"	3"	\$8.56	\$8.93	\$9.30

**RUBBER SLEEVES**

Used in place of masking tape to cover holes on the perforated flasks. Sleeves easily fit over flasks to contain investment while pouring. Remove sleeve prior to burnout.

Item	Order #	OD	Height	12+	6+	1+
P	21-7008	3¾"	4"	\$8.10	\$8.45	\$8.80
Q	21-7009	4"	5¾"	\$11.36	\$11.86	\$12.35
R	21-7010	4"	7"	\$15.23	\$15.89	\$16.55

**FLASK TONGS**

Steel tongs used for lifting small and large perforated flasks to and from oven.

Order #	Length	12+	6+	1+
57-0680	15"	\$5.70	\$6.03	\$6.70

**PLATINUM FLASK LINER SHEET**

Order #	Description	W × L × Thickness	12+	6+	1+
21-7976	Flask Liner	8" × 31" × 1/16"	\$12.11	\$12.83	\$14.25



Casting

1-2 hour
set time



A



B



C

Silica

KERR® SATIN CAST 20 INVESTMENT

Satin Cast 20 satisfies the most critical caster demanding exacting tolerances. Kerr's "Extra-fine grain, zero mineralized" cristobalite powder achieves defect-free castings and satin smooth finishes. Consistently superior results for metals melting under 2000°F/1093°C.

Item	Order #	Description	Weight	12+	6+	1+
A	22-4731	Satin Cast 20	4.4 lbs (2kg)	\$15.30	\$16.20	\$18.00
B	22-4738	Satin Cast 20	33 lbs (15kg)	\$32.20	\$33.60	\$35.00
C	22-4740	Satin Cast 20	99 lbs (45kg)	\$66.72	\$70.65	\$78.50



Silica

KERR® SATIN CAST DIAMANTE®

With more than 20 years of experience as a "Stone in Place" investment, Satin Cast 20 is known as the most popular investment for this process. An investment formulated specifically for "Stone in Place" casting for higher temperature burnout.

Order #	Description	Weight	12+	6+	1+
22-4750	Satin Cast	99 lbs (45kg)	\$69.55	\$75.42	\$83.80



Silica

No chemical
needed to remove

KERR® PLATINITE®

Platinite is a high strength and high temperature investment for casting platinum, stainless steel, and alloys that melt above 2000°F. Platinite forms a strong mold with good dimensional accuracy and caters to the exacting needs for excellence. An exceptionally smooth surface is achieved without cracks and fissures, which drastically reduces finishing time.

Order #	Description	Weight	12+	6+	1+
22-4739	Platinite	99 lbs (45kg)	\$89.34	\$94.59	\$105.10

Stuller offers a wide range of investments to fit your casting needs	Gold	Silver	Platinum	Palladium	Stainless Steel	Titanium	Stone in Place	Mix with Water	Mix with Binder	Ok for CAD/CAM Resins	Di-Vester Needed	UOM	Order #
Kerr Satin Cast 20	•	•						•		•		33 lbs	22-4738
Kerr Satin Cast Diamante	•	•					•	•				99 lbs	22-4750
Kerr Opticast			•	•	•				•		•	77 lbs	22-4755
R&R Ultra-Vest	•	•						•		•		50 lbs	22-4771
R&R Solitaire	•	•					•	•		•		50 lbs	22-4772
R&R Ultra-Vest MAXX	•			•				•		•		50 lbs	22-4776
Grobet Investment	•	•						•				25 lbs	22-4761
Invest C/P			•	•	•	•			•	•	•	11 lbs	22-7047
Platinite			•		•			•				11 lbs	22-4739

R&R® ULTRA-VEST® INVESTMENT

Ultra-Vest® Investment offers casters smooth mixing, controlled setting, clean breakout, and excellent surface finish. Ultra-Vest® eliminates the watermarking defects seen with many other investments. Ultra-Vest® offers superior performance and unmatched consistency. For low temperature mold materials. Rapid prototype cooling.

Order #	Description	Weight	12+	6+	1+
22-4771	Ultra-Vest	50 lbs (23kg)	\$44.21	\$46.13	\$48.05



Above 30% Silica

R&R® ADVANTAGE AND PLASTICAST

A. **R&R Advantage** investment provides silver, brass, and bronze jewelry casters with an economical investment that reduces excess metal and watermarking defects for dependable casting results and maximum profits. For low temperature mold materials.

B. **R&R Plasticast** investment provides casters using plastic and wax/ plastic pattern materials with a mold material that meets the high expansion demands of the pattern material while maintaining mold surface and dimensional integrity.

Item	Order #	Description	Weight	12+	6+	1+
A	22-4773	Advantage	50 lbs (23kg)	\$36.94	\$38.54	\$40.15
B	22-4778	Plasticast	50 lbs (23kg)	\$47.84	\$49.92	\$52.00



Less than 50% Silica.



Less than 80% Silica

R&R® ULTRA-VEST® MAXX

An investment that can be used for yellow gold, white gold, and palladium, MAXX is very stable for high-melt temperatures, flask temperatures, burnout temperatures, and casting temperatures. MAXX eliminates orange peel defects associated with metal and other mold reactions, or any other challenges in the burnout process associated with plastic and resin pattern materials. For low temperature mold materials. Rapid prototype cooling.

Order #	Description	Weight	12+	6+	1+
22-4776	Ultra-Vest® MAXX	50 lbs (23kg)	\$50.23	\$52.42	\$54.60



Less than 50% Silica

R&R® SOLITAIRE INVESTMENT

Solitaire Investment is designed to provide critical protection to stone-in-place castings. Solitaire Investment protects castable stones during the wax-burnout phase of flask preparation.

Order #	Description	Weight	12+	6+	1+
22-4772	Solitaire Investment	50 lbs (23kg)	\$48.81	\$50.93	\$53.05

Less than 50% Silica



Safety masks, gloves and aprons located on pages 474-481.

Casting



Sold in box of 32 individual 160g bags or in 5kg bulk package.



Sold in 20kg bulk package.



C



D



E

INVESTMENT C/P AND LIQUID C/P (BINDER)

A-D. Allows for same-day platinum casting. Sets up in minutes, burns out clean, and allows for 2 hour burnout.

E-G. Phosphate bonded speed burnout investment for all common metals for jewelry casting except titanium. Developed for precious metals with high melting points. Better surface quality by reduced particle size. Improved composition for the highly demanding requirements of rapid prototype materials.

Item	Order #	Description	12+	6+	1+
A	21-7047	5kg Invest C/P Speed Investment	\$53.59	\$55.92	\$58.25
B	21-7048	20kg Invest C/P Speed Investment	\$185.01	\$193.06	\$201.10
C	21-7049	Investment Liquid for C/P 1000ml	\$14.03	\$14.64	\$15.25
D	21-7057	Investment Liquid for C/P 5000ml	\$68.82	\$71.81	\$74.80
E	21-7058	Invest C/P Speed Investment with 1L Invest Liquid	\$60.90	\$63.55	\$66.20
F	21-7059	Invest RP Investment for Rapid Prototype Materials	\$51.52	\$53.76	\$56.00
G	21-7060	Invest RP Investment with 1L Invest Liquid	\$60.90	\$63.55	\$66.20

INVESTMENT WARNING! This material contains crystalline silica and shows evidence of causing cancer in humans. (ARC Group 1) Prolonged exposure may cause lung injury (silicosis). Users must comply with all applicable health and safety regulations relating to the safe handling of crystalline silica. See MSDS for information. California Prop 65 Warning: This product contains crystalline silica, a chemical know in the state of California to cause cancer.



F



G



GROBET USA® INVESTMENT

Formulation contains a defoamer blended right into the material. Gives a low rise when vacuuming, a wider water usage for greater yield flexibility, and easier removal of air bubbles on wax pattern's face.

Order #	Description	Weight	12+	6+	1+
22-4761	Investment	50 lbs	\$75.07	\$78.34	\$81.60



H



J



K

PLASTIC MEASURING CYLINDERS AND SYRINGE

Item	Order #	Height	Capacity	12+	6+	1+
H	21-7400	16"	250ml	\$10.63	\$11.09	\$11.55
J	21-7401	6"	1000ml	\$11.18	\$11.66	\$12.15
K	58-2559		35ml	\$2.38	\$2.72	\$3.40

INVESTMENT SCALES

Item	Order #	Description	Capacity	12+	6+	1+
A	21-7700	Investment Scale	10 lb	\$19.76	\$20.93	\$23.25
B	21-7701	Investment Scoop		\$2.30	\$2.40	\$2.50
C	21-7705	Investment Scale	20 lb	\$68.47	\$72.50	\$80.55
D	21-7720	Investment Scale	6.5 lb	\$13.47	\$14.27	\$15.85



TASO MIXING BOWL SCALE

Measure, mix and pour all-in-one bowl with the Taso mixing bowl scale.

- Weight Capacity: 11 lb / 5000 g
- Scale Mode, units: Pounds, Ounces, Grams
- Volume Mode, units: Cups, Fluid Ounces & Milliliters
- Increments: 0.1 oz, 1 g, 1/8 cup, 1/8 fl. oz, 1 ml

Order #	Description	12+	6+	1+
E 21-7721	Taso Mixing Bowl Scale	\$49.45	\$52.36	\$58.18

RUBBER MIXING BOWLS

Flexible for easy pouring.

Item	Order #	Diameter	Height	Capacity	12+	6+	1+
F	21-7602	5"	5"	1 pint	\$4.60	\$4.80	\$5.00
G	21-7603	6"	6"	1½ quart	\$8.28	\$8.64	\$9.00
H	21-7604	8½"	6½"	1 gallon	\$17.20	\$17.95	\$18.70



PRO-CRAFT® INVESTMENT VIBRATOR

Three-speed, variable vibrator with great weight and a low center of gravity. Quiet operation with great surface area on platform. Comes with an extra-long cord and three-prong grounded plug. 120V, 40W, 60Hz.

Order #	Description	12+	6+	1+
21-7710	Investment Vibrator	\$70.17	\$74.30	\$82.55



INTERVAL TIMER

Interval timer for investment mixing. One to 60 minute timer. Weight ¾ lbs.

Order #	Description	W x L x Depth	12+	6+	1+
21-9010	Interval Timer	2¼" x 4⅝" x ½"	\$17.60	\$18.63	\$20.70

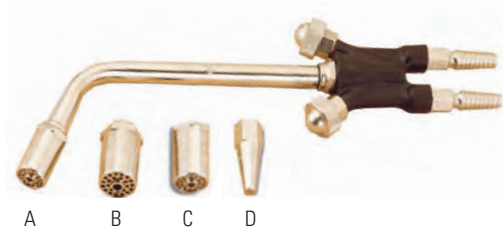

Casting

**HI-HEAT TORCH**

The mixing chamber of the Model D blowpipe is designed for use with natural, artificial, or bottled gas, but not for acetylene. Produces intense, perfectly formed flame. Use standard 1/2" hose with C-clamps.

Item	Order #	Description	12+	6+	1+
A	54-4535	Hi-HeatTorch	\$59.46	\$62.96	\$69.95
B	54-4536	Large Gas/Air Torch (Extra Tip)	\$11.86	\$12.56	\$13.95
C	54-4537	Small Gas/Air Torch (Extra Tip)	\$6.72	\$7.11	\$7.90
D	54-4538	Oxygen/Gas Torch (Extra Tip)	\$6.72	\$7.11	\$7.90

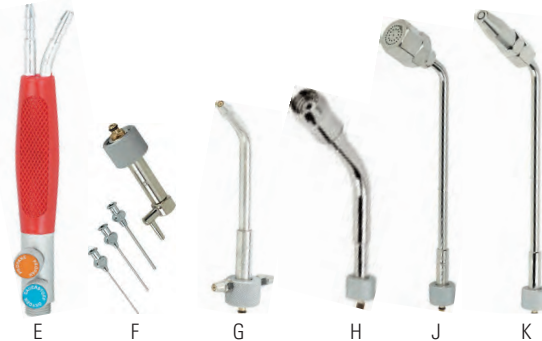
**THE SWISS TORCH**

The most versatile, handy, lightweight, and reliable torch on the market. Use with propane and natural gas/oxygen. Not for use with acetylene. The selection of heads permit pinpoint to large flames for melting. 100% made in Switzerland.

Item	Order #	Description	12+	6+	1+
E	14-1660	Swiss Torch Body	\$101.15	\$107.10	\$119.00
F	14-1661	Micro Head w/3 Needle Nozzles	\$131.75	\$139.50	\$155.00
G	14-1662	Hoke® Standard Head	\$131.75	\$139.50	\$155.00
H	14-1663	Short Melting Head	\$97.75	\$103.50	\$115.00
J	14-1664	Long Melting Head	\$97.75	\$103.50	\$115.00
K	14-1665	Platinum Head	\$89.68	\$94.95	\$105.50



Used to help prevent dangerous reverse gas flow.

CHECK VALVE

Item	Order #	Description	12+	6+	1+
L	14-1790	For Fuel Gas Regulator	\$12.45	\$13.19	\$14.65
	14-1795	For Oxygen Regulator	\$12.45	\$13.19	\$14.65

**CHECK VALVES/FLASHBACK ARRESTORS**

Stops flashback fires by preventing reverse gas flow with automatic reset between flashes. Solid brass case is durable and easy to install. Fits standard 3/8" "B" connections. (Use with hose 14-0780).

Item	Order #	Description	12+	6+	1+
M	14-0769	For Fuel Gas Lines	\$35.70	\$37.80	\$42.00
N	14-0770	Oxygen Flashback Arrestor	\$35.70	\$37.80	\$42.00

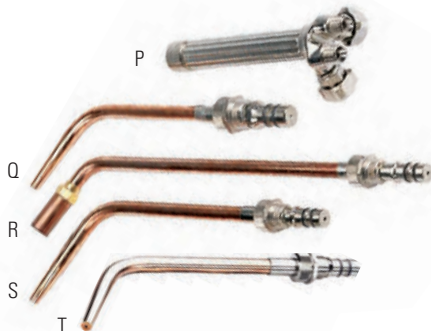
**SMITH CASTING TORCHES**

Smith torch handle is nickel plated. For casting platinum, gold, or silver. Note: Flashback arrestors recommended for use with all casting torches. UL listed with a lifetime warranty.

Item	Order #	Description	12+	6+	1+
P	14-5060	Smith Torch Handle	\$140.25	\$148.50	\$165.00
Q	14-5062	Oxygen/Acetylene Tip	\$103.95	\$103.95	\$103.95
R	14-5063	Oxygen/Acetylene Heating Tip	\$84.41	\$89.37	\$99.30
S	14-5064	Oxygen/Propane Tip	\$53.98	\$57.15	\$63.50
T	14-5065	Oxygen/Hydrogen Tip	\$50.96	\$53.96	\$59.95

**MELTING DISH WITH HANDLE**

Ideal for torch melts. Removable wooden handle resists heat, which makes it easy to melt and pour metals.

Item	Order #	Description	12+	6+	1+
U	22-7911	Crucible	\$13.11	\$13.68	\$14.25
V	22-7910	Crucible with Handle	\$20.65	\$21.55	\$22.45
W	22-7912	Handle	\$6.49	\$6.77	\$7.05

MELTING DISHES KITS

These kits come with two melting dishes that are made of fused silica for melting precious metals, and one handle ideal for torch melts with removable, wooden handle that resists heat. For temperatures up to 2,800°F (1,538°C).

Small Kit contains: 20 DWT crucible, 40 DWT crucible, and holder.

Large Kit contains: 100 DWT crucible, 175 DWT crucible, and holder

Item	Order #	Description	Diameter × H	12+	6+	1+
A	22-7913	Small Holder		\$9.29	\$9.70	\$10.10
	22-7913KIT	Small Kit		\$17.57	\$18.34	\$19.10
B	22-7914	Large Holder		\$10.35	\$10.80	\$11.25
	22-7914KIT	Large Kit		\$20.65	\$21.55	\$22.45

CRUCIBLE DISHES

C	22-7930	16 DWT (148g)	1¾" × ⅝"	\$4.00	\$4.18	\$4.35
D	22-7931	19 DWT (196g)	2¼" × ¾"	\$4.14	\$4.32	\$4.50
E	22-7932	25 DWT (155g)	3" × 1"	\$6.12	\$6.38	\$6.65
F	22-7933	35 DWT (420g)	4" × 1⅜"	\$5.34	\$5.57	\$5.80

**GRAPHITE CRUCIBLES**

These heat resistant crucibles, often called black lead, withstand temperatures up to 3,000°F (1,649°C) and will tolerate thermal shock.

Item	Order #	Diameter × H	12+	6+	1+
G	22-8000	4⅞" × 3⅞"	\$34.13	\$35.62	\$37.10
H	22-8000	5¼" × 4¼"	\$38.27	\$39.94	\$41.60
J	22-8000	6⅞" × 5⅞"	\$50.69	\$52.90	\$55.10

**STRAIGHT SIDES MELTING DISHES**

Used for high-temperature (2,500°F) melting of platinum, chromium, gold, alloys, and other metals.

Item	Order #	Diameter × H	Capacity	12+	6+	1+
K	22-7937	3⅞" × 2"	18 oz (510g)	\$11.27	\$11.76	\$12.25
L	22-7938	3¾" × 3½"	40 oz (1134g)	\$13.39	\$13.97	\$14.55

**MELTING CRUCIBLES**

These melting crucibles have thick walls that will withstand temperatures up to 2,500°F. Made of clay bonded fused silica, these heavy-duty crucibles have spouts (lips) for easy pouring. Use for torch welding only.

Item	Order #	Diameter × H	Capacity	12+	6+	1+
M	22-7942	2⅞" × 2⅞"	18 oz	\$9.29	\$9.70	\$10.10
N	22-7943	3½" × 3½"	45 oz	\$12.33	\$12.86	\$13.40
P	22-7944	4" × 4½"	80 oz	\$16.47	\$17.18	\$17.90
Q	22-7946	5" × 5¼"	150 oz	\$22.45	\$23.42	\$24.40

**MORGAN MELTING DISH (WESGO)**

Used for high-temperature melting of platinum, chromium, gold, alloys, and other metals.

Item	Order #	Description	Capacity	12+	6+	1+
R	22-8150	Straight Side	8 oz (227g)	\$22.13	\$23.09	\$24.05
S	22-8152	High Back	10 oz (282g)	\$25.35	\$26.45	\$27.55



Casting

**HOODED CRUCIBLE WITH SPOUT**

Hooded, high-temperature ceramic crucibles for steel.

Item	Order #	Description	Capacity	12+	6+	1+
A	22-3702	500 DWT	110ml	\$9.38	\$9.79	\$10.20
B	22-3703	380 DWT	80ml	\$8.56	\$8.93	\$9.30

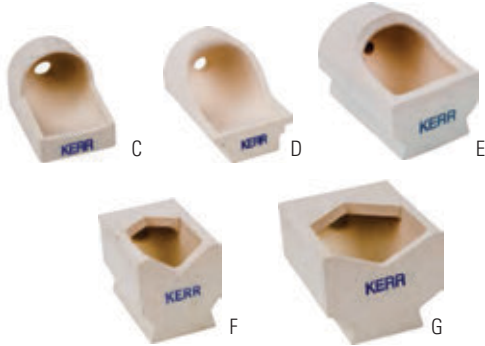
**KERR® CLAY CRUCIBLES**

These high quality, clay/ceramic replacement crucibles are for melting gold, silver, and other non-ferrous metals. Use with centrifugal casting machines.

Item	Order #	Description	W x L	Capacity	12+	6+	1+
C	22-4700	Standard	1 $\frac{1}{8}$ " x 1 $\frac{1}{8}$ "	1 oz	\$32.61	\$34.03	\$35.45
D	22-4701	Standard	1 $\frac{1}{8}$ " x 2 $\frac{1}{2}$ "	2 $\frac{1}{2}$ oz	\$26.91	\$28.08	\$29.25
E	22-4702	4" x 6"	1 $\frac{1}{8}$ " x 3 $\frac{3}{8}$ "	7 oz	\$33.72	\$35.18	\$36.65
F	22-4703	4" x 6"	1 $\frac{1}{8}$ " x 3 $\frac{3}{8}$ "	12 oz	\$36.16	\$37.73	\$39.30
G	22-4704	4" x 6"	1 $\frac{7}{8}$ " x 3 $\frac{3}{8}$ "	120 oz	\$38.27	\$39.94	\$41.60

**PLATINUM CRUCIBLE**

Use only with the large Yasui platinum casting machine.

Item	Order #	Description	Capacity	12+	6+	1+
H	22-3700	Large Crucible	400g	\$78.75	\$82.18	\$85.60

**MORGAN CRUCIBLES (WESGO)**

Used for high-temperature melting of platinum, chromium, gold, alloys, and other metals.

Item	Order #	Description	Capacity	12+	6+	1+
J	22-4610	Slotted A	13 oz (185g)	\$30.50	\$31.82	\$33.15
K	22-4612	Large D	11 oz (315g)	\$47.29	\$49.34	\$51.40

**CRUCIBLES**

These crucibles are designed for use with the tabletop casting machine from Ti-Research.

Item	Order #	Description	Max Capacity	12+	6+	1+
L	21-7050	Medium	up to 150g	\$21.57	\$22.51	\$23.45
M	21-7051	Large	up to 250g	\$24.29	\$25.34	\$26.40
N	21-7052	Extra Large	up to 450g	\$28.29	\$29.52	\$30.75

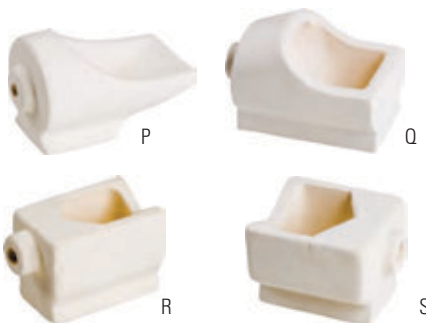
**CASTING CRUCIBLES**

These crucibles for centrifugal casting machines are suitable for melting metals in temperatures up to 2,000°F. Square casting crucibles retain heat and are excellent for use with centrifugal casting machines.

Item	Order #	Description	Capacity	12+	6+	1+
P	22-4620	Replacement Crucible	9 oz	\$20.65	\$21.55	\$22.45
Q	22-4624	Round	9 oz	\$24.06	\$25.10	\$26.15
R	22-4631	Square	12 oz	\$18.35	\$19.15	\$19.95
S	22-4634	Square	18 oz	\$19.85	\$21.00	\$23.35

REVERSIBLE INGOT MOLD

Used to recycle scrap metal. One side makes sheet and the other side makes wire in 3, 4, 5, and 6mm sizes. C-clamp secures and releases the plates.

Item	Order #	Description	Capacity	12+	6+	1+
A	22-8770	Wire and Sheet	130 DWT (221g)	\$42.20	\$44.69	\$49.65



COMBINATION INGOT MOLD

Offers versatility and ease of use. Used to recycle scrap metal into sheet and wire. Machined from high quality tool steel. Adjustable double-sided frame with C-clamp handle.

- Flat Faces for flat or square ingots.
- Width adjustable from 0 to 46mm. Height 76mm, thickness 3mm.
- Bored Faces to form round wire.
- Wire diameters: 3, 4, 5, and 6mm. Wire length up to 76mm.

Item	Order #	Description	Capacity	12+	6+	1+
B	22-8771	Wire and Sheet	175 DWT	\$31.88	\$33.75	\$37.50



ADJUSTABLE INGOT MOLD

Used for recycling clean scrap into sizes useful for rolling sheet. Adjustable width and height. Machined from high quality tool steel. Width adjustable from 0 to 46mm. Height 76mm, thickness 3mm. Weight 2.75 lbs.

Item	Order #	Description	Capacity	12+	6+	1+
C	22-8772	Sheet Mold	140 DWT	\$25.93	\$27.45	\$30.50



DURSTON OPEN INGOT MOLD

Used to form ingots or bullion.

Item	Order #	W x L x H	Capacity	12+	6+	1+
D	22-8700	35mmx90mmx35mm	50 DWT (78g)	\$20.06	\$21.24	\$23.60
E	22-8701	35mmx90mmx35mm	80 DWT (124g)	\$20.57	\$21.78	\$24.20
F	22-8702	65mmx155mmx40mm	200 DWT (310g)	\$22.44	\$23.76	\$26.40



DURSTON INGOT MOLD FOR WIRE

Used to pre-form metal into wire strips before rolling or drawing. Can make three sizes:

- $\frac{3}{4}$ " x $\frac{5}{16}$ " x $6\frac{1}{16}$ " (19mm x 8mm x 170mm)
- $\frac{3}{8}$ " x $\frac{3}{8}$ " x $6\frac{1}{16}$ " (9mm x 9mm x 170mm)
- $\frac{9}{32}$ " x $\frac{5}{16}$ " x $6\frac{1}{16}$ " (7mm x 8mm x 170mm)

Item	Order #	W x L x H	12+	6+	1+
G	22-0510	1¼" x 10½" x 1¼"	\$8.93	\$9.45	\$10.50

DURSTON REVERSIBLE INGOT MOLDS

Precision ground. Six sizes of wire. Adjustable flat up to 70mm.

Item	Order #	Description	W x L	12+	6+	1+
	22-8710	4 Hole	60mmx110mm	\$180.46	\$191.07	\$212.30
H	22-8711	6 Hole	60mmx110mm	\$115.60	\$122.40	\$136.00
J	22-8712	Flat	50mmx130mm	\$106.25	\$112.50	\$125.00

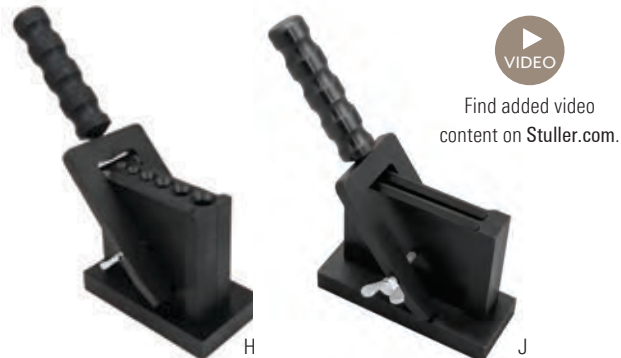

Find added video content on Stuller.com.

Casting

**BORAX**

Specially prepared for making flux for jewelry soldering. Dissolves easily to make a paste. Inhibits the formation of oxides on metal surfaces and allows solder to flow more easily.

Item	Order #	Description	Weight	12+	6+	1+
A	54-2520	Cone	4 oz	\$6.07	\$6.34	\$6.60

MAGIC BORAX™

Borax Granular powder is an excellent, general purpose flux. Excellent also for glazing clay crucibles to extend crucible life.

Item	Order #	Description	Weight	12+	6+	1+
B	54-4432	Boric Acid Granular	16 oz	\$7.31	\$7.63	\$7.95

MAGIC BORIC ACID POWDER®

High-grade, superfine boric acid powder. Use as high-grade flux and deoxidizing agent. Can also be mixed with denatured alcohol to make soldering flux.

Item	Order #	Description	Weight	12+	6+	1+
C	54-4433	Boric Acid Powder	16 oz	\$7.86	\$8.32	\$9.25

**SUPER FLUX**

Special formulation of flux for jewelers. Will minimize oxidation on molten metal. Use on precious metals for torch melting or furnace melting.

Item	Order #	Description	Weight	12+	6+	1+
D	54-4411	Super Flux	8 oz	\$12.42	\$12.96	\$13.50

**FIRESCOFF®**

Revolutionary heat-activated ceramic spray coating. Firescoff™ combines a scale preventer, a high performance non-fluorinated flux (for both hard and soft solder), and the convenience of easy removal in warm water, all-in-one.

Other benefits include:

- Integrated non-fluorinated flux for consistent soft and hard solder welding.
- Perform multiple soldering operations without waiting
- Enjoy strong, non-brittle, void-free welds
- Greater control when reticulating with silver or gold
- Superior performance over boric acid and Batterns® flux or paste flux
- Provides stray heat protection for gemstones
- Prevents scaling of metal alloys including gold, stainless steel, copper, and silver
- Warm water cleanup—less than two minutes in an ultrasonic cleaner
- Remove dangerous pickling acids from the workbench
- Alcohol-free—no dangerous flash, no frustrating burn residue
- No smell, no outgassing
- Significant improvement in safety over traditional methods

Item	Order #	Description	Size	12+	6+	1+
E	54-4413	Small Bottle	1 oz	\$9.78	\$10.35	\$11.50
F	54-4414	Bulk Dispenser	3000 ml	\$191.41	\$199.73	\$208.05
G	54-4414	Large Bottle	4½ oz	\$23.89	\$25.29	\$28.10

CENTRIFUGAL TABLETOP CASTING MACHINE

The new CAST/T is a compact centrifugal casting machine for the production of precision castings. The casting machine includes a 30mm and 60mm casting flask, the necessary handling tools, wax disks, and investments. The casting machine also includes one 150 gram and one 250 gram crucible for a flame melt. The manufacturer highly recommends a propane/oxygen flame. The CAST/T can cast up to 450 grams of gold, platinum, silver, or other alloys in one mold. The CAST/T is designed to handle your small casting requirements (up to 25 rings) and includes a step-by-step operating manual and video CD. Made in Germany. Two-year limited manufacturer's warranty.

Item	Order #	Description	1+
A	21-7040	Tabletop Machine Kit	\$3,445.00
B	21-7043	Metal Ring Sectioned (30mm)	\$85.25
C	21-7044	Metal Ring (30mm)	\$71.00
D	21-7045	Metal Ring (60mm)	\$72.00
E	21-7054	Mold Base	\$45.40
F	21-7046	Wax Discs for standard (pack of 25)	\$26.80
G	21-7049	Liquid	\$15.25
H	21-7053	Stainless Steel Cleaning Solution 100ml	\$9.05
J	22-5811	2-Part - Silicone Mold Rubber	\$74.15
K	21-7605	Mix Kit	\$790.10
L	21-7055	Ceramic Liner (55mm W x 40mm L)	\$52.55
M	21-7056	Ceramic Liner (25mm W x 40mm L)	\$44.45
N	21-7059	Invest RP Investment for Rapid Prototype Materials	\$56.00
P	21-7060	Invest RP Investment with 1L Invest Liquid	\$66.20



BEAD BLASTING

Bead blasting cabinets help to remove hardened investment, oxidation, and heat scale from metals, and they also produce a satin finish on jewelry. This is accomplished by using dry abrasives such as glass beads or granule abrasives. It is recommended that some sort of dust collection is used with beading cabinets.

Q. Includes handpiece with 0.060" ID ceramic nozzle, foot operated, 1/8" male fitting for all sources, 80-90 psi compressed air required. 1.5 CFM. Use glass beads media 150 mesh or finer.

R. A heavy duty cabinet with handheld pencil style etcher, recirculates glass beads, Plexiglas® top opening window, requires 90-100psi compressed air. 1.5CFM. Includes incandescent light receptacle, rubber gloves, and rear vent for vacuum system.

S. High pressure trigger operated gun, Plexiglas top slant window. Includes safety valve, rear vent, receptacle for bulb, and 18" rubber gloves.

Item	Order #	Description	Size	1+
Q	23-0048	Bottle Blaster		\$109.95
R	23-0055	Bench Top Blaster	16" x 12" x 18"	\$201.50
	23-0039	Foot Valve Assembly		\$69.95
	23-0044	Mylar® Shields	8" x 11"	\$17.00
	23-0043	Lined Gloves (pair)	15"	\$19.10
	23-0047	Pencil Blaster Ceramic Tip	0.048"	\$16.90
	23-0047	Pencil Blaster Ceramic Tip	0.06"	\$16.90
S	23-0061	Bead Blaster	22½" x 18" x 14"	\$197.95
	23-0062	Bead Blaster Ceramic Nozzle		\$18.00
	23-0044	Mylar® Shields	14" x 17"	\$45.55
	23-0043	Unlined Rubber Gloves (pair)	18"	\$28.10



Casting

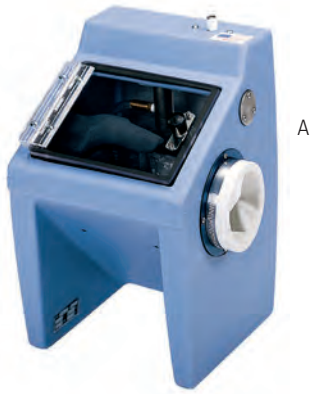

E-Z VIEW SAND BLASTER

The E-Z Blaster unit is designed to remove hardened investment from castings and to also produce a rich satin finish on jewelry. The cabinet is made of a one-piece polymer body, which will never rust or leak. The unit automatically recirculates the media and features an adjustable pressure regulator and a self-cleaning ceramic nozzle. It also includes a bright light for easy viewing and a double filter bag to ensure a clean interior. Made in the USA. - Requires 80-90 PSI.

- Comes with 5 lbs of quartz abrasive that provides a strong, satin finish.



Item	Order #	Description	Volts	W x L x H	1+
A	23-0080	E-Z Sand Blaster	110	10" x 11" x 15"	\$510.40



GLASS BEAD BLASTER

Produces a stream of micro-sized glass beads for removing stubborn investment particles, oxidation, and heat scale from metal. Leaves articles with smooth finish. Made in the USA.

- Large viewing window with hinged door for easy clean-out
- Illuminated interior (40-watt bulb maximum)
- Neoprene glove sealed to opening for holding article
- Easily controlled instant action gun
- Gun is attached to 3 1/2" air line hose with fittings
- Connects to compressor (sold separately), capable of producing 30-60 psi pressure with at least a 5 gallon tank
- Portable - Weighs only 10 lbs when filled with 5 lbs of glass beads
- Includes 5 lbs waterproof micro-sized glass beads

Item	Order #	Description	Size	1+
B	23-0050	Bead Blaster	9" x 9" x 9"	\$425.00
C	23-0051	Filter		\$38.95
D	23-0052	Neoprene Gloves		\$15.75
E	23-0053	Air Gun	6.19 oz	\$74.15
F	23-0054	On Face Tube	6.17 oz	\$27.40
G	23-0049	Replacement Media	5 lbs	\$18.95



GLASS BEADS

Ceroglass crushed glass is made of clean and carefully screened soda lime glass. Low cost angular media with a high cutting speed. Primarily used in open blast cleaning and difficult cleaning applications.

Item	Order #	Grit	12+	6+	1+
H	23-0073	20-40	\$10.35	\$10.80	\$11.25
J	23-0074	50-80	\$10.35	\$10.80	\$11.25
K	23-0075	70-120	\$10.35	\$10.80	\$11.25
L	23-0076	120-230	\$10.35	\$10.80	\$11.25
M	23-0077	140-325	\$10.35	\$10.80	\$11.25
N	23-0078	170-400	\$10.35	\$10.80	\$11.25

GLASS BEAD ADVANTAGES

- Fast cutting action
- Safe substitute for sand (does not cause silicosis)

- Improves performance of other media by blending
- Improved water jet cutting and cleaning performance
- Cleans thoroughly and very efficiently

- Lower disposal and maintenance costs
- Available in a full range of sizes

INVESTMENT MIXING INSTRUCTIONS

RECOMMENDED WATER/POWDER RATIOS

REGULAR Castings

Ladies' Rings, pendants, filigree & intricate-wax patterns.

40 ml water to 100 grams powder

Water		Yields Approximate	
avg oz	ml	cubic inch	CC
6.1	172	21	349

HEAVY Castings

Heavy Ladies' Rings, Mens' Rings & School Rings

36 ml water to 100 grams powder

Water		Yields Approximate	
avg. oz	ml	cubic inch	CC
6.4	182	22	359

To get the number of pounds of investment needed to fill any particular flask, divide the cubic inch content of the flask by 20.

To get flask content in cubic inches. Round Flask = $0.7854 \times \text{dia.}^2 \times \text{height}$. Square Flask = width \times length \times height.

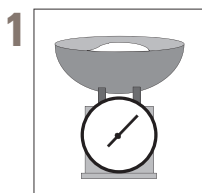

1 Weigh investment.

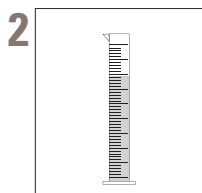

2 Measure water.

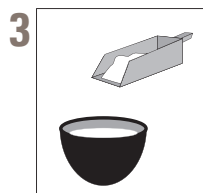

3 Always add investment to water.



4 Mix for 3 to 3½ minutes.

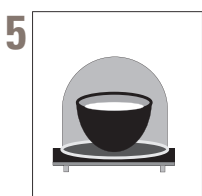

5 Vacuum 20 seconds after bell.

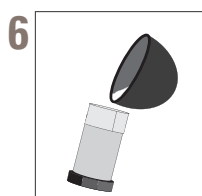

6 Pour into flask.

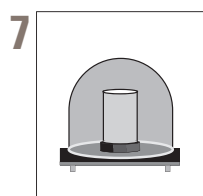

7 Vacuum up to 90 seconds.

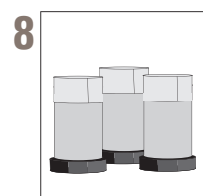

8 Leave still for 2 hours.

TEMPERATURE CONVERSION TABLE

Conversion Formulas °F = (9/5 × °C) + 32° °C = 5/9 (°F - 32°)

°F	°C	°F	°C	°F	°C	°F	°C	°F	°C	°F	°C
600	316	830	443	1120	604	1410	766	1640	893	1930	1054
610	321	840	449	1130	610	1420	771	1650	899	1940	1060
620	327	850	454	1140	616	1430	777	1660	904	1950	1066
630	332	860	460	1150	621	1440	782	1670	910	1960	1071
640	338	870	466	1160	627	1450	788	1680	916	1970	1077
650	343	880	471	1170	632	1460	793	1690	921	1980	1082
660	349	890	477	1180	638	1470	799	1700	927	1990	1088
670	354	900	482	1190	643	1480	804	1710	932	2000	1093
680	360	910	488	1200	649	1490	810	1720	938	2010	1099
690	366	920	493	1210	654	1500	816	1730	943	2020	1104
700	371	930	499	1220	660	1510	821	1800	982	2030	1110
710	377	1000	538	1230	666	1520	827	1810	988	2040	1116
720	382	1010	543	1240	671	1530	832	1820	993	2050	1121
730	388	1020	549	1250	677	1540	838	1830	999	2060	1127
740	393	1030	554	1260	682	1550	843	1840	1004	2070	1132
750	399	1040	560	1270	688	1560	849	1850	1010	2080	1138
760	404	1050	566	1280	693	1570	854	1860	1016	2090	1143
770	410	1060	571	1290	699	1580	860	1870	1021	2100	1149
780	416	1070	577	1300	704	1590	866	1880	1027	2110	1154
790	421	1080	582	1310	710	1600	871	1890	1032	2120	1160
800	427	1090	588	1320	716	1610	877	1900	1038	2130	1166
810	432	1100	593	1330	721	1620	882	1910	1043		
820	438	1110	599	1400	760	1630	888	1920	10		



A new generation of steam cleaning performance, quality and durability.

- External sight glass with cover
- Low water cut-off
- Water intake valve with back up flow prevention
- Adjustable thermostat
- Insulated nozzle assembly
- 2.3 gallon capacity
- 70-80 PSI steam pressure
- 1,500 watts
- 110 volt
- 13 amp
- One-year warranty



Cleaning



Item	Order #	Description	1+
A	15-0510	Steamer with Solenoid 14½" x 10½" x 14"	\$1,395.00
REPLACEMENT PARTS			
B	15-0512	Safety Valve	\$255.45
C	15-0514	Nozzle	\$16.65
D	15-0509	Check Valve	\$29.95
E	15-0515	Ball Valve ½"	\$27.55
F	15-0513	Plastic Housing for Glass Tube	\$36.00
G	15-0520	Sight Glass 6"	\$12.30
H	15-0516	Foot Switch and Cord	\$79.00
J	15-0511	Solenoid Valve	\$106.00
K	15-0519	Thermostat	\$35.00
L	15-0517	Ball Valve ¼"	\$33.45
M	15-0530	Heating Element	\$76.75
N	15-0525	Low Water Cut-Off	\$51.50
P	15-0518	Pressure Gauge	\$38.00
Q	15-0531	Rubber Gasket	\$4.15
R	15-0524	On/Off Switch	\$6.35
S	15-0012	Ferrule Fitting	\$3.00



Hoffman offers technologically-superior micronic cleaning. Grease, grime, and micro-deposits disappear in seconds — no messy rag, lint, or baths. Oxidation and deposits are removed from the tiniest crevices for a bright, sparkling finish — faster, easier. Inexpensive to operate, Hoffman Steemkleen machines offer outstanding value. Choose from the 2 or 6 gallon capacities that start up faster, recover temperature and pressure faster, and finish your job faster with less labor. Automatic safety valves make our micronic cleaners safer.

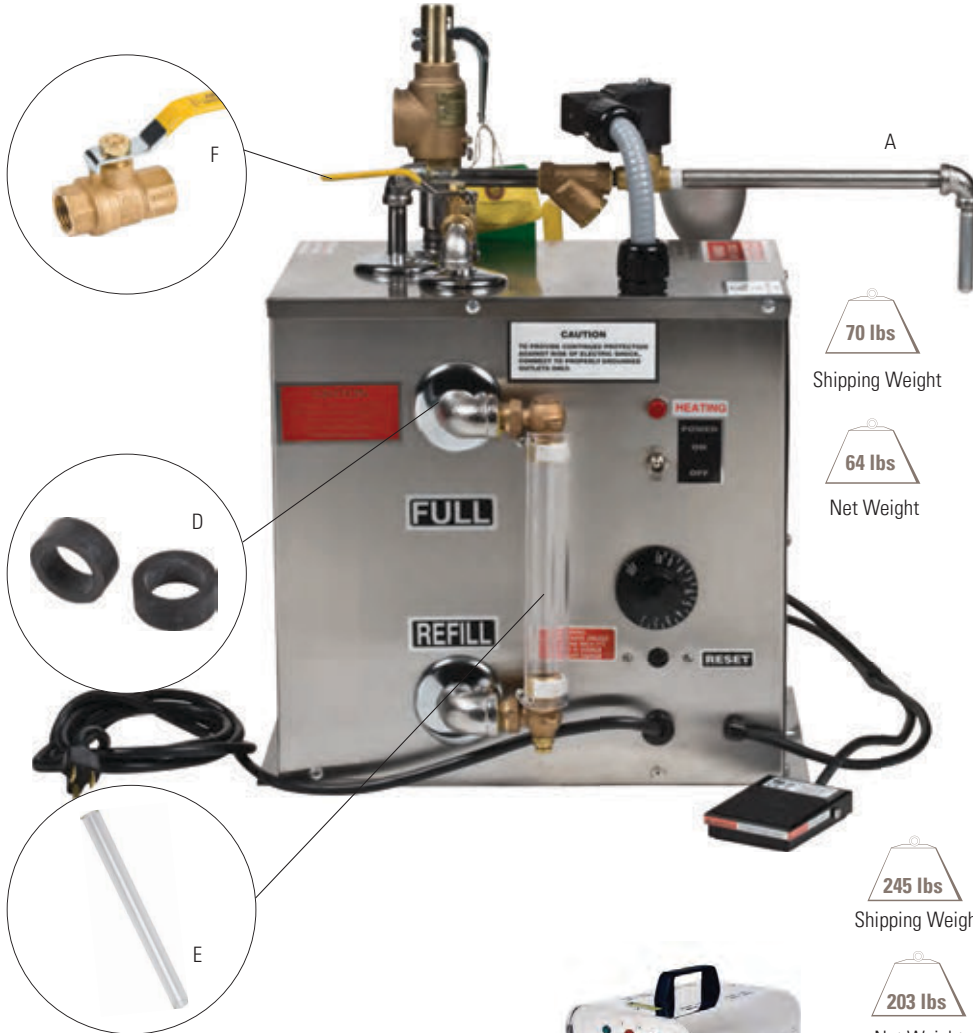

A. Model JEL-3

- A. S. M. E. and U.L. Approved
- Tank capacity: 2 gallons
- Saves time, boosts productivity
- Develops 70-90 PSI steam
- Safety shielded sight glass with stainless steel cabinet
- Plugs into any 110 or 220 VAC outlet
- Easy reservoir refill manuel
- Adjustable thermostat controls
- Auto low water cut-off
- Total operator control
- Rust-inhibited pressure tank (no rust or corrosion)
- Finger tip or foot switch controls
- 110 Volts/13 Amps
- 17¾" W × 23½" H × 20½" D

70 lbs
Shipping Weight

64 lbs
Net Weight

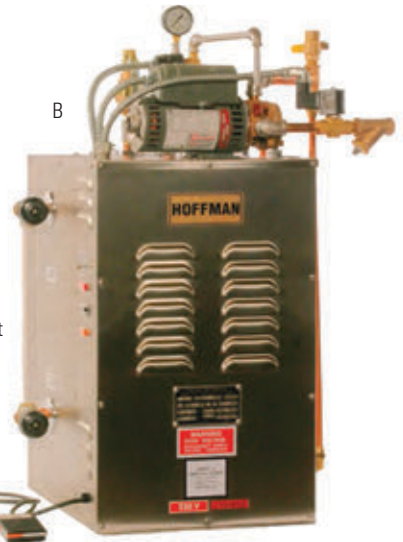

B. Model JEL-10

- A. S. M. E. and U.L. Approved
- Tank capacity: 6 gallons
- 220 Volts/3 phase/60Hz
- Steam outlet: solenoid with foot switch
- Easy reservoir refill (pump & motor)
- Fast temperature/pressure recovery
- Auto low water cut-off
- 22" W × 35" H × 22" D

245 lbs
Shipping Weight

203 lbs
Net Weight



C. Model Gem 3

- Screw in element for quick reheat and recovery
- No high-pressure boiler to worry about leaks
- Uses distilled water straight from a jug
- Electric foot pedal control
- 9" W × 11" H × 11" D

Item	Order #	Description	1+
A	15-0503	JEL-3, 2 gallons	\$1,438.90
B	15-0505	JEL-10, 6 gallons	\$4,310.00
C	15-0501	Gem 3 Steamer	\$780.00

REPLACEMENT PARTS

D	15-0521	Washers (Pack of 2)	\$3.95
E	15-0522	Sight Glass Cover	\$27.70
F	15-0517	Ball Valve	\$33.45
	15-0520	Sight Glass	\$21.10
	15-0502	Solenoid Valve for JEL-3	\$197.05
	15-0504	Heating Element	\$162.70
	15-0506	Replacement Gasket	\$5.95
	15-0525	Low Water Cut-Off	\$51.50
	15-0516	Foot Switch and Cord	\$79.00

RELIABLE

RELIABLE STEAMERS

- Provides hours of continuous steam
- Low water light indicator
- Uses regular tap water
- Stainless steel tank
- Water level stick
- Incology heating elements
- 120 Volts
- Made in Italy
- Limited 1 year warranty, 3 year warranty on tank

These steamers are ideally suited for use in jewelry stores and workrooms for cleaning away leftover wax, plaster waste, and other debris, and for polishing the final product. Steam deodorizes and sanitizes with heat and moisture, and since the only ingredient required for these is regular tap water, cleaning has never been safer, healthier, or more environmentally friendly. They provide up to 6 hours of steam from a stainless steel tank.



D. Model i800A

D. Model i800A

- Unlimited continuous steam when connected to a water supply
- Water Capacity: 1.3 gallons (5 liters)
- Up to 80 PSI, 5.5 bar operating pressure
- Two 1200 watt heating elements (1 spare)
- 10 amps power consumption
- 20 amp plug required
- Automatic shut-off of pump
- Boiler thermostat reset switch
- Direct connection to water line

- Optional portable water supply
- Unit weight: 36 lbs.
- Shipping weight: 46 lbs.

A. Model i500A

- Four hours of continuous steam
- Water Capacity: .66 gallons (2.5 liters)
- Up to 50 PSI, 3.4 bar operating pressure
- 1,000 watt copper heating element
- 10 amps power consumption
- 1,800 watt electrical (iron and boiler)
- Rated for up to 8 hours of use per day
- Unit weight: 13 lbs.
- Shipping weight: 16 lbs.



A. Model i500A

Find added video content on Stuller.com.



B. Model i600A

- Six hours of continuous steam
- Water Capacity: 1¼ gallons (4.5 liters)
- Up to 65 PSI, 4.5 bar operating pressure
- 1200 watt heating element
- 10 amps power consumption
- Unit weight: 16.7 lbs.
- Shipping weight: 23 lbs.



B. Model i600A

Find added video content on Stuller.com.



C. Model i700A

- Six hours of continuous steam
- Water Capacity: 2.37 gallons (9 liters)
- Up to 70 PSI, 4.8 bar operating pressure
- 10 amps power consumption
- Two 1200 watt heating elements (1 spare)
- Unit weight: 30.35 lbs.
- Shipping weight: 33.9 lbs.



C. Model i700A

Item	Order #	Description	W x D x H	1+
A	15-1110	Reliable Model i500A	14" x 8¾" x 11"	\$599.00
B	15-1105	Reliable Model i600A	13" x 8¾" x 15"	\$899.00
C	15-1106	Reliable Model i700A	12½" x 14¼" x 20½"	\$1,199.00
D	15-1112	Reliable Model i800A	11½" x 11" x 39"	\$2,299.00
E	15-1116	Foot Switch		\$120.00
F	15-1109	Solenoid Valve		\$125.00

SHARPERTEK STEAMER

Sleek table-top unit makes a great impression and delivers reliable, superior performance with its compact, durable, state-of-the-art design. Atmospheric technology directly converts distilled water into high-powered, super-heated, dry steam cleaning energy on demand at 70-90psi. Effectively cleans dirt, residue, and build-up with excellent penetration and exceptional control for even the most delicate of jewelry. Safe, efficient, green, requires no boiler tank, harsh chemicals or detergents, and the tank stays cool to the touch. Proudly designed, engineered, and manufactured in the U.S.A. to meet the highest standards anywhere in the world.

Order #	Description	Model	W x L x H	1+
15-1000	Steam Cleaner	S1500-R	9" x 14" x 10"	\$395.00



SILVER DRAGON STEAMER

The Silver Dragon is a boilerless steam cleaner that will deliver 90-125 PSI of constant steam in up to two minutes. This tabletop steamer is foot-pedal controlled, made of 20 gauge stainless steel, and uses 1,200 watts, 110 volts. UL approved. Use only distilled water.

Order #	Description	W x L x D	1+
15-1005	Steam Cleaner	9" x 10" x 13"	\$725.00



MAGIC CLEAN STEAM

Special, high concentrate prevents scale, rust buildup, and mineral deposits inside steamer. Use this super-concentrated additive to help prolong the life of your steamer. Note: Use one cap full each time steamer is filled.

Order #	Description	12+	6+	1+
54-4430	16 oz Bottle	\$4.80	\$5.09	\$5.65



JEWEL JET STEAM

The worlds #1 home jewelry cleaner is back and better than ever. The Jewel Jet Jewelry Steam Cleaner uses the amazing power of steam to clean your jewelry. Professional jewelers have been using steam to produce those brand new jewelry looks for years and now you can too. With 8 oz of tap water (no chemicals), you can produce amazing results in your own home!

- Two-year warranty
- Modern styling retains design cues that are distinctly Jewel Jet
- Stainless steel boiler has 10 times the burst capacity as aluminum
- Pressurized safety cap locks under pressure and releases steam to prevent build-up
- Auto shut-off after 10 minutes of non-use
- Increased burst steam releases 50% more steam than before
- Pressure and heat sensors shut the unit down if too much pressure or heat is detected

Order #	Description	Height	1+
15-2008	Pro Personal Steamer	10"	\$89.95



- LED under-lighting near the nozzle makes visual inspection easier
- LED indicator light blinks red when unit is warming up and solid blue when ready
- UL Listed
- 30-40Psi



ELMA® S-SERIES ULTRASONICS

Powerful professional ultrasonic cleaning for all applications. The series increases the ultrasonic effect farther to obtain even better results. Made in Germany.



23-5928 Model S30



23-5931 Model S40



23-5929 Model S100

- The sweep function, developed in the Elma laboratories, guarantees a sound field distribution by way of continuous shifting.
- The degas function efficiently accelerates the degassing process in the cleaning liquid, particularly in freshly mixed baths.
- When used in tough long-term operations you will find that the new units with their functional design fully meet the demands of any cleaning task.

- Ultrasonic frequency of 37 kHz
- 3/8" Drain duct/diameter
- Sweep function
- Degas mode
- One year limited warranty
- Variable heat

Model S30

- Tank Capacity: 2½ quarts (2.75 liters)
- Tank Dimensions: 9½" × 5½" × 3¼"
- Total Power Consumption: 80/280 watts
- Heating Power: 0/200
- Voltage: 110V
- Unit Weight: 3.3 lbs.

Model S40

- Tank Capacity: 3¾ quarts (4.25 liters)
- Tank Dimensions: 9½" × 5½" × 5¼"
- Total Power Consumption: 140/340 watts
- Heating Power: 0/200 watts
- Voltage: 110V
- Weight: 4 lbs.

Model S100

- Tank Capacity: 9½ quarts (9.5 liters)
- Tank Dimensions: 11½" × 9½" × 5¼"
- Total Power Consumption: 150/550 watts
- Heating Power: 0/400 watts
- Voltage: 110V
- Weight: 5.9 lbs.

Order #	MFG Model #	W × D × H	1+
23-5928	Elma Model S30	11½" × 7¼" × 8½"	\$579.90
23-5931	Elma Model S40	11½" × 7¼" × 10½"	\$795.90
23-5929	Elma Model S100	14½" × 10¼" × 10½"	\$1,199.00

ELMA® P-SERIES ULTRASONIC

The ideal cleaner for all applications. The units are easy to operate with clearly arranged displays showing frequency and settings vs. actual settings of selected temperature. Several special features make these units perfect for intensive cleaning applications.



23-5950 Model P30H



23-5950 Model P60H



23-5950 Model P70H

- Pulse Operating mode to intensify the cleaning effect.
- High frequency for dissolving dirt or rouge in hard to reach areas.
- Low frequency—Noise reduction, ideal for prolonged cleaning times.
- Power reduction by increments of 10% to aid in sensitive surfaces.
- Degas Mode—Freshly mixed cleaning liquids are saturated with air, which reduces the cleaning effect. Degas mode removes such oxygen.
- Made in Germany.

- Ultrasonic frequency of 37/80 kHz
- 3/8" Drain duct diameter
- Sweep function
- 115-120 Volts
- One year limited warranty

Model P30H

- Tank Capacity: 2½ quarts (2.75 liters)
- Tank Dimensions: 9½" × 5½" × 3¼"
- Total Power Consumption: 320/300 watts
- Heating Power: 250 watts
- Unit Weight: 3.3 lbs

Model P60H

- Tank Capacity: 3¾ quarts (5.75 liters)
- Tank Dimensions: 11½" × 5¼" × 5¼"
- Total Power Consumption: 580/550 watts
- Heating Power: 500 watts
- Unit Weight: 5.75 lbs

Model P70H

- Tank Capacity: 8½ quarts (5.6 liters)
- Tank Dimensions: 19½" × 5½" × 3¼"
- Total Power Consumption: 820 watts
- Heating Power: 750 watts
- Unit Weight: 5.6 lbs

Order #	MFG Model #	W × D × H	1+
23-5950	Elma Model P30H	11½" × 7¼" × 8½"	\$859.00
23-5950	Elma Model P60H	14½" × 7 3/10" × 10½"	\$1,189.00
23-5950	Elma Model P70H	22½" × 7" × 8¼"	\$1,289.00



ELMA® X-TRA ULTRASONICS - HEAVY DUTY

Elma's latest generation of ultrasonic cleaners meet high requirements of life span and durability. The ElmaSonic X-Tra series stands out, due to the longer lasting cavitation-resistant, stainless steel used in all tanks. Powerful, short heat-up time and optimized sound field distribution with sweep function. Complete with two cleaning modes and temp control range of 70°-175°F. Elma offers a three-year warranty against leakage under normal usage. Made in Germany.

- Ultrasonic frequency of 35kHz
- Sweep function
- 115 Volts

Model 30H

- Tank Capacity: 2 quarts (2.75 liters)
- Tank Dimensions: 9½" x 5¼" x 4"
- Total Power Consumption: 120 watts
- Heating Power: 400 watts
- Drain Duct Diameter: ¾"
- Weight: 16 lbs

Model 50H

- Tank Capacity: 3½ quarts (4.5 liters)
- Tank Dimensions: 9½" x 5¼" x 4"
- Total Power Consumption: 160 watts
- Heating Power: 400 watts
- Drain Duct Diameter: ¾"
- Weight: 22 lbs

Model 70H

- Tank Capacity: 5 quarts (6.5 liters)
- Tank Dimensions: 9½" x 5¼" x 4"
- Total Power Consumption: 180 watts
- Heating Power: 400 watts
- Drain Duct Diameter: ¾"
- Unit Weight: 33 lbs

Model 150H

- Tank Capacity: 13 quarts (14 liters)
- Tank Dimensions: 12" x 8"
- Total Power Consumption: 300 watts
- Heating Power: 800 watts
- Drain Duct Diameter: ½"
- Weight: 35 lbs



23-5936 Model 30H



23-5938 Model 50H



23-5942 Model 150H



23-5940 Model 70H

Order #	MFG Model #	W x D x H	1+
23-5936	Elma Model 30H	14½" x 8½" x 9½"	\$1,236.00
23-5938	Elma Model 50H	14½" x 8½" x 11½"	\$1,299.00
23-5940	Elma Model 70H	14½" x 8½" x 11½"	\$1,537.00
23-5942	Elma Model 150H	16¾" x 12¾" x 13¾"	\$2,127.00

PARTS HOLDING BASKET

Baskets used for keeping small parts together in ultrasonics or steam cleaners. Springs apart for quick unloading.

Item	Order #	Description	Basket	Length	12+	6+	1+
A	23-1000	Small Basket	1½"	6½"	\$4.04	\$4.28	\$4.75
B	23-1010	Large Basket	2"	6"	\$3.87	\$4.10	\$4.55
C	23-1012	Large Brass Basket	1"		\$5.40	\$5.72	\$6.35
D	23-1015	Small Basket with Handle	5¾"		\$4.04	\$4.28	\$4.75
	23-1020	Large Basket with Handle	5¾"		\$4.25	\$4.50	\$5.00

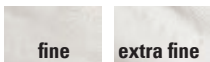

CLEANING BASKET

Stainless steel cleaning baskets are universal. With practical side clips, they can be used with smaller and larger units.

Item	Order #	L x W x D	Mesh	Fits Tank	12+	6+	1+
E	23-5915	5" x 4" x 1¼"	Fine	2 qt	\$10.84	\$11.48	\$12.75
F	23-5920	5½" x 4½" x 1½"	Extra-Fine	2 qt	\$14.07	\$14.90	\$16.55
G	23-6200	5½" x 2½" x 1½"	Fine	1 pt	\$24.31	\$25.74	\$28.60
H	23-6209	5¼" x 5" x 3½"	Extra-Fine	2 qt	\$14.41	\$15.26	\$16.95
J	23-6210	9" x 5" x 3½"	Extra-Fine	3 qt	\$15.30	\$16.20	\$18.00



Cleaning



Window shows the minute just set or minute remained in ultrasonic cleaning process

Timer setting

Start/Pause and Memory setting

Power switch

Heating setting

Actual °C/°F window shows the current temperature of cleaning fluid inside the tank

STULLERSONICS

StullerSonic provide you with a high quality ultrasonic in two-quart, three-quart, or six-quart sizes. This one puts the control in your hands with a multitude of options.

- Play/pause button
- Customizable timer (1-30 minutes)
- 30°C to 80°C temperature settings
- 37KHz of power
- 110V-230V dual voltage
- Power consumption: 60 or 120 watts
- Includes stainless steel basket and tweezers
- Shuts off automatically after four hours
- Uses auto-excitation type, all 1C automatic operation
- Stable quality and low noise



- 2 quart volume
- Internal tank dimensions: 150mm × 137mm × 100mm



A



- 3 quart volume
- Internal tank dimensions: 238mm × 138mm × 100mm

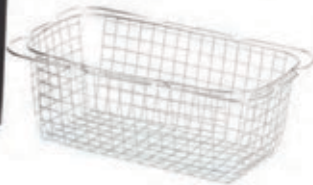

B



- 6 quart volume
- Internal tank dimensions: 302mm × 152mm × 150mm



C

These high quality ultrasonics are available in two-quart, three-quart, or six-quart sizes. Includes a basket and small mesh cylinder basket for cleaning small parts.

Item	Order #	Description	1+
A	23-5712	2 Quart	\$265.00
B	23-5712	3 Quart	\$345.00
C	23-5712	6 Quart	\$595.00

L&R® Quantrex® systems are manufactured with vinyl-clad steel housings, stainless steel tanks, and premium system components. Their contemporary design and quiet operation are a complement to the importance of beauty and elegance within the jewelry industry. The Quantrex® line is backed by the most comprehensive warranty on the industry—all defects in materials or workmanship are covered for 2½ years.

PERSONAL-SIZED ULTRASONIC CLEANER

- Tank dimensions: 4¾" x 3¾" x 2½"
- Tank capacity: 18oz
- Overall dimensions: 5¾" x 4⅞" x 4¾"
- 117V AC
- Peak output: 70 watts
- Heater, timer, and basket not included



Order #	Description	1+
23-5850	PC3	\$170.00
23-5851	Stainless Steel Basket	\$42.00

QUANTREX® Q90

- Tank dimensions: 5⅞" x 5¾" x 4"
- Timer and heater included
- Capacity: 2 quarts (1.9 liters)
- 117V AC
- Overall dimensions: 6⅞" x 6¾" x 8⅞"
- Fits 2-quart baskets
- Maximum temperature 150°
- Peak output: 160W, 43 kHz
- Not for use with soft stones



Order #	Description	1+
23-5854	Quantrex® 90	\$315.00

QUANTREX® Q140

- Tank dimensions: 9⅞" x 5¾" x 4"
- Peak output: 270W
- Capacity: 3¾ quarts
- Timer and heater
- Overall dimensions: 10¾" x 6¾" x 8"
- 117V AC
- Fits 2-quart and 3-quart baskets



Order #	Description	1+
23-5858	Quantrex® Q140	\$455.00

QUANTREX® Q210

- Tank dimensions: 9⅞" x 5¾" x 4"
- Peak output: 400W, 43 kHz
- Capacity: 6 quarts
- Timer and heater included
- Fits 2-quart or 3-quart baskets



Order #	Description	1+
23-5859	Quantrex® Q210	\$897.00

Cleaning



Model 100SB

- 4" W x 5" H
- Stainless steel basket
- 6 oz. tank capacity
- 4 oz. Gem Sparkle concentrate
- Battery operated
- Ring hanger



Model 200 TURBO

- 5 3/4" W x 5 3/4" H
- Stainless steel basket
- 12 oz. tank capacity
- 32 oz. Gem Sparkle concentrate
- Available in 110V or 220V
- Ring hanger



Model 309 TURBO

- 10 3/4" W x 6 3/4" H
- Stainless steel basket
- 12 oz. tank capacity
- 32 oz. Gem Sparkle concentrate
- Available in 110V or 220V
- Ring hanger

SPEED BRITE IONIC CLEANING SYSTEMS

The Speed Brite Ionic Cleaning System is an odorless, silent process that instantly removes tarnish from gold and silver and will not damage soft stones such as emeralds, opals, turquoise, and pearls. Operation is quick and easy. Ions are attached to the contaminants rather than the metal and stones. The surface tension is reduced, which permits the contaminants to be lifted away by soft bubbles. Made in the USA.

Item	Order #	Description	1+
A	23-6500	Model 100SB	\$63.55
B	23-6501	Model 200 Turbo	\$125.00
C	23-6502	Model 309 Turbo	\$185.00
GEM SPARKLE CLEANING SOLUTIONS			
D	23-6610	32 oz (liquid)	\$16.85
E	23-6611	1 gallon (liquid)	\$31.50
F	23-6612	32 oz (powder)	\$17.95
G	23-6612	8 oz (powder)	\$13.50



STULLERSONIC CLEANER

Ideal machine for the small trade shop or for the retail counter. Handy and robust, the sandwich transducer system ensures high reliability. Complete stainless steel construction prevents rusting or oxidation. Compact in size and price but not in quality. Comes with 15-minute timer switch. Made in Germany.

- Maximum temperature: 140°F
- Weight: 6 lbs.
- Capacity: 0.85 quarts (0.8 liters)
- Frequency: 35 kHz
- Power consumption: 30 watts, heater 100 watts
- Tank dimensions: 7 1/2" x 3 1/2" x 2 1/4"
- Unit dimensions: 8 1/16" x 3 7/8" x 6 3/4"

Item	Order #	Description	1+
H	23-5874	Stullersonic with Heater	\$349.90
J	23-6208	Stainless Steel Basket	\$40.25



ELMASONIC ULTRASONIC CLEANER

An industrial-strength ultrasonic designed for the retail counter. Features a stainless steel tank encased in an attractive plastic housing and hinged cover. Made in Germany.

- Plastic basket included
- Capacity: 9 quarts (9 liters)
- 0-120 minute timer
- Power consumption: 40 watts
- Frequency: 35 kHz
- Tank dimensions: 7 7/8" x 3 5/16" x 2 3/8"
- Unit dimensions: 9 5/16" x 3 5/16" x 2 3/8"

Order #	Description	1+
23-5872	Ultrasonic Cleaner	\$249.95

MEDELCO® SONIC CLEANER

Sonic cleaning has many of the advantages of an ultrasonic without the high cost. Excellent promotional item, comes in an attractive resale box. Housing and tank are sturdy plastic. Supplied with instructions, 8 ounces concentrated cleaning solution, lid, and perforated dip tray.

Made in the USA.

- Tank dimensions: 3" x 2" high
- Capacity: 8 ounces



1.5 lbs

Order #	Description	Voltage	12+	6+	1+
15-0580	Sonic Cleaner	120V	\$11.69	\$12.38	\$13.75

PERSONAL ULTRASONIC CLEANER

- Use only plain tap water to clean
- Remove dirt effectively; results can be seen with bare eyes
- Clean articles to shine just like new
- Three-minute automatic shutoff
- Significant product structure advancement
- Tightened lid design for effective noise reduction
- Improved products durability and safety by water resistance capability enhancement
- Stainless steel tank



1.5 lbs

Order #	Description	Capacity	12+	6+	1+
23-5901	Ultrasonic Cleaner	1 pint	\$35.62	\$37.71	\$41.90

DIGITAL ULTRASONIC

Professional cleaning power is available in this simple, small, and well priced unit. This ultrasonic is designed for home and professional use, with enough power and durability to be used in a jewelry store. Simply add clean, distilled water, jewelry cleaner concentrate (sold separately), and your jewelry in the tank. Start the cleaning cycle and watch as your jewelry is cleaned the professional way. You'll be pleased as dirt, body oil, soap scum, dead skin, and other filmy substances are loosened and removed in a matter of minutes. Tank dimensions: 6¾" x 5⅓" x 2¾"



3.8 lbs

Order #	Description	W x L x H	12+	6+	1+
23-5904	Ultrasonic with Basket	7" x 9" x 6"	\$58.52	\$61.97	\$68.85

ULTRA-CR BY POLYCHEM

Ultra-CR is a mildly alkaline, concentrated cleaning solution specially formulated for the jewelry industry. Ultra-CR easily removes all buffing and polishing compounds from gold, silver, platinum, brass, copper, and rhodium without the use of ammonia or other harsh chemicals. Patented surfactants provide superior rinsability, which eliminates streaking and dulling. Ultra-CR has gone through comprehensive development and testing at Stuller's manufacturing facility. It's proven to be longer lasting and superior to other cleaners on the market. Ships UPS Ground only. (Dilute 10 to 1.)



Item	Order #	Description	Container Volume	12+	6+	1+
A	54-4450	Container	1 gallon	\$20.72	\$23.31	\$25.90
B	54-4452	Container	2½ gallon	\$49.47	\$53.64	\$59.60
C	54-4451	Drum	15 gallon	\$258.57	\$269.81	\$281.05
D	54-4455	Drum	55 gallon	—	—	\$724.20



A



B

L&R® ULTRASONIC SOLUTIONS

A. Waterless solution is designed to prevent varnish formation and leaves an excellent polish on all watch parts.

B. Waterless cleaning solution especially formulated for use with all L&R rinses and cleaning machines. Rinse with No. 54-4395. Will not spot or streak. Contains ammonia.



Item	Order #	Description	Container Volume	1+
A	54-4391	Extra-Fine Watch Cleaner	1 gallon	\$47.70
B	54-4392	#111 Ammoniated Watch Cleaner	1 gallon	\$46.70

C. Waterless, non-ammoniated solution, formulated for use on ultrasonic cleaning units. Won't spot or streak. Greater solvency on greases, gummed oils, and containments. Rinse with No. 54-4395.

D. Ready-to-use, waterless, and non-ammoniated clock cleaning solution.



C



D

Item	Order #	Description	Container Volume	1+
C	54-4393	#566 Non-Ammoniated Watch Cleaner	1 gallon	\$47.70
D	54-4397	#677 Clock Cleaner	1 gallon	\$47.70

E. Biodegradable super concentrate used at a 3 to 20% concentration with water. Removes most buffing compounds without discoloration of metal. Can be heated in an ultrasonic machine up to 180°F to enhance cleaning. Contains no film-forming corrosion inhibitors so parts can be plated without any additional cleaning. Do not use on aluminum.

F. Ellanar cleaner is an effective solution without the added ammonia. Safe to use on gold, diamonds, and gems.



E



F

Item	Order #	Description	Container Volume	1+
E	54-4402	Buffing Compound Cleaner	1 gallon	\$37.95
F	54-4403	Ellanar Jewelry Cleaner	1 gallon	\$35.00

ULTRASONIC/ STANDARD WATCH RINSE

G. Fast drying, long lasting, and won't break down. Specially formulated for use with Watch Cleaner #111. Can be used with any watch cleaning solution. Compatible with all cleaners.

H. Clear petroleum distillate, specially blended by L&R. Contains no benzoin or chlorinated solvents. Leaves no oily film. Dries fast. Use in ultrasonic with Cleaner #111; in standard machines, with No-Foam Watch Cleaner. Compatible with all cleaners.



G



H

Item	Order #	Description	Container Volume	1+
G	54-4395	Standard Rinse	1 gallon	\$46.70
H	54-4394	#3 Rinse	1 gallon	\$47.70

MYXIS SHINE BRITE ULTRASONIC CONCENTRATE

- Shine Brite works well on jewelry such as mesh and rope chains, diamond bracelets, cluster rings, precious metals, and watch bands.
- Non-toxic, non-acidic, and designed to dissolve the dirt and grime away faster than any other cleaner on the market.
- Rinses away with warm water and light steam.
- Now available in 15 no-mess, pre-measured packages that make 1 gallon (each) of Shine Brite cleaning solution, reducing your shipping costs.

Item	Order #	Description	12+	6+	1+
A	54-4476	Ultrasonic Concentrate	\$33.44	\$34.90	\$36.35



CLEANING CONCENTRATE

Tivaclean is an electrocleaning concentrate for both metals and plastics. It is an orange powder that, when mixed with water, changes to a fluorescent green to ensure full rinsing. Tivaclean also contains anti-foaming agents for low sudsing and a deodorant to suppress odor. A biocatalyst is also present for biodegradability and eliminates the need to use toxic chlorinated solvents. In solution, Tivaclean has a non-caustic Ph of 9-10. Tivaclean is also a great ultrasonic cleaner. It can be used at room temperature; however, heating the solution to a temperature between 160°F and 180°F enhances its performance.

Item	Order #	Container Volume	12+	6+	1+
B	54-4401	1 lb	\$6.21	\$6.48	\$6.75



STULLER SUPER SONIC SOAP

A special blend of cleaning agents, including ammonia, that produces the ultimate in ultrasonic cleaning. Very effective in removing tripoli, bobbing, and polishing compounds. Highly concentrated, dilute with up to 10 parts water.

Item	Order #	Container Volume	12+	6+	1+
C	54-4447	1 gallon	\$12.71	\$13.46	\$14.95

PUMP ADAPTER

D. Pump adapter for 5 gallon drum. Allows for the easy directional dispensing of liquids into receiving container.

E. Pump adapter for 5 gallon drum. Heavy duty pump with angled spout to prevent dripping. Fits 3/4" and 2" openings.

Item	Order #	Description	12+	6+	1+
D	54-4458	18" Barrel - 8 oz per stroke	\$27.46	\$29.07	\$32.30
E	54-4439	12" Barrel - 5 oz per stroke	\$32.26	\$34.16	\$37.95

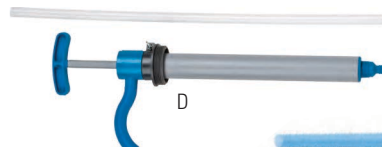

MAGIC GREEN ULTRASONIC CLEANING POWDER

Non-ammoniate, concentrated. Mix one ounce per gallon of water.

Item	Order #	Container Volume	12+	6+	1+
F	54-4400	32 oz	\$17.68	\$19.17	\$21.30
	54-4404	10 lb (not shown)	\$56.17	\$58.61	\$61.05
	54-4405	50 lb (not shown)	\$316.65	\$343.35	\$381.50



MAGIC LUSTER CLEANING SOLUTION

Super concentrated ultrasonic cleaner for gold and silver dilutes with up to 40 parts water. Works fast at room temperature, extra fast in heated water. Non-ammoniated, biodegradable.

Item	Order #	Container Volume	12+	6+	1+
G	54-4407	1 gallon	\$16.77	\$18.18	\$20.20
	54-4408	5 gallons (not shown)	\$74.89	\$79.29	\$88.10



ULTRASONIC PARTS BASKET

Fine, plastic mesh mounted on plastic legs to keep basket away from bottom of ultrasonic and will prevent even your smallest stone from being lost. Has up to 16 hanging hooks. Great for use with chains also. Basket has convenient handle for easy removal.

Order #	Description	Height	Depth	12+	6+	1+
23-2000	Parts Basket	3 7/8"	4 7/8"	\$15.73	\$16.65	\$18.50



PLASTIC STRAINERS

Plastic strainers with nylon mesh are great for many uses. Nylon will not scratch jewelry and is perfect for dipping jewelry.

Item	Order #	Description	Width	Depth	12+	6+	1+
A	23-5900	Small Basket	5"	2 7/8"	\$1.62	\$1.71	\$1.90
B	23-5905	Large Basket	9"	2 1/2"	\$2.59	\$2.75	\$3.05

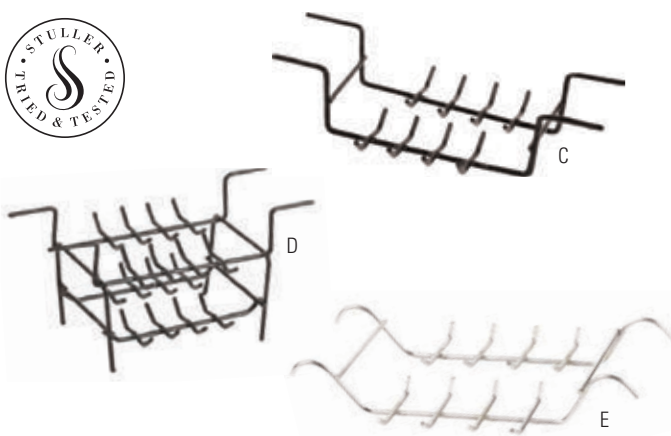

ULTRASONIC RING RACKS

Fits one- and two-quart ultrasonics lengthwise and three-, six-, and ten-quart tanks crosswise. Plastic coated, rust-resistant hook and bar racks increase ultrasonic cleaning efficiency and will not mar objects.

Item	Order #	Description	Length	12+	6+	1+
C	23-6205	Coated Rack - No Legs		\$3.61	\$3.83	\$4.25
D	23-6206	Coated Double Rack with Legs		\$6.29	\$6.66	\$7.40
E	23-6204	Stainless Steel Rack - No Legs		\$8.80	\$9.32	\$10.35
F	23-1030	8 Hooks (16 Rings)	12"	\$7.40	\$7.83	\$8.70
G	23-1032	12 Hooks (24 Rings)	14 1/2"	\$8.07	\$8.55	\$9.50
	23-1034	Replacement Hooks - pack of 5		\$3.87	\$4.10	\$4.55



Rings not included

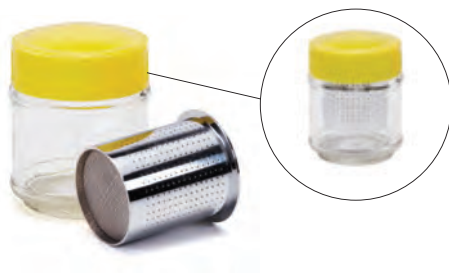

STONE WASHER

Clean loose stones with a glass container for washing.

Order #	Description	12+	6+	1+
64-4010	Stone Washer	\$7.11	\$8.12	\$10.15

BAMBOO TWEEZERS

Tweezers made from bamboo have a gentle grip and will not damage small delicate objects. Bamboo tweezers are highly recommended for use in optical inspection and production environments. They have excellent insulation and are chemical-resistant.

Item	Order #	Description	Length	12+	6+	1+
A	57-7517	Small Pointed	6"	\$4.04	\$4.28	\$4.75
B	57-7518	Large Pointed	9½"	\$4.21	\$4.46	\$4.95
C	57-7519	Large Flat Blunt	7"	\$4.89	\$5.18	\$5.75



COATED FORCEPS/STEAM TWEEZERS

Used for handling items being steamed and/or cleaned in ultrasonics. Plastic coating on tips provide chemical resistance along with a firm grip for retrieving items without scratching. Made of nickel-plated steel. Plastic coating may vary in color.

Item	Order #	Description	Length	12+	6+	1+
D	57-7510	Cross-Locking	6½"	\$9.99	\$10.58	\$11.75
E	57-7515	Straight	8"	\$9.35	\$9.90	\$11.00
F	57-7516	Straight	10"	\$10.20	\$10.80	\$12.00



ECONOMICAL STEAM TWEEZERS

Chrome-plated. Chemical resistance is provided by the plastic coating on tips. Plastic coating may vary in color.

Order #	Description	Length	12+	6+	1+
57-9200	Steam Tweezers	10"	\$6.16	\$6.53	\$7.25



STEAMOSTAT

Made of stainless steel, the Steamostat features PVC-covered tips for holding jewelry while steam cleaning.

Order #	Description	Length	12+	6+	1+
46-4555	Steamostat	8"	\$9.78	\$10.35	\$11.50



HEMOSTAT FORCEPS

Used as clamps when working with small articles. Made of stainless steel. Box-joint construction and serrated jaws allow firm holding. Contains three-position locking device.

Item	Order #	Description	Length	12+	6+	1+
G	46-4545	Straight Forceps	5"	\$5.74	\$6.08	\$6.75
H	46-4550	Curved Forceps	5"	\$5.53	\$5.85	\$6.50





SPARKLE SPARKLE EVERYDAY CLEANER

This jewelry cleaner is perfect for all of your jewelry - even your delicate opals and pearls. Its refreshing botanical formula boasts scents of citrus, mint, and aloe extracts for powerful, yet gentle cleaning power. Made in USA.

Kit Includes:

- (1) Bottle of 60 ml powerful jewelry cleaner spray
- (1) Bottle of 120 ml refill
- (2) Jewelry cleaning micro brushes
- (1) 6" x 4" polishing cloth

Order #	Description	1+
54-9029	Jewelry Cleaning Kit	\$12.95

- Spray and rinse convenience
- Cleans in less than 30 seconds
- Leakproof bottle
- No residue after cleaning
- Safe/non-toxic
- Non-abrasive
- Sold in 1 oz. bottles



SPARKLE SPARKLE

Now you can polish and care for your jewelry with premium jewelry care products. Unique, leak-proof spray bottle design means less mess than a traditional dip silver cleaner, and it's safe to take along when traveling.

Sold individually or as a set. Set includes: one cleaner; one lint-free cloth; two brushes and one velvet pouch. Rekindles the brilliance of white and yellow gold jewelry. Helps extend the life of rhodium coatings.

Kit (54-9034) includes all of the following:

- Sparkle Sparkle Gold Jewelry Cleaner
- Two GemBrushes
- SparkleSparkle™ Lint-Free GemCloth
- Luxurious velvet GemPouch



Item	Order #	Description	Size	12+	6+	1+
A	54-9030	Gold Cleaner	1 oz	\$3.44	\$3.56	\$3.95
B	54-9031	Platinum Cleaner	1 oz	\$3.44	\$3.56	\$3.95
C	54-9032	Silver Cleaner	1 oz	\$3.44	\$3.56	\$3.95
D	54-9033	Delicate Cleaner	1 oz	\$3.44	\$3.56	\$3.95
E	54-9034	Gold Kit		\$6.05	\$6.26	\$6.95
	54-9035	Platinum Kit		\$6.05	\$6.26	\$6.95
	54-9036	Silver Kit		\$6.05	\$6.26	\$6.95
	54-9037	Delicate Kit		\$6.05	\$6.26	\$6.95



QUICK-CLEAN CLEANER

The quickest, easiest, and most effective way to clean your jewelry at home. Our Quick-Clean system is a fully contained foam with an agitating chamber that protects jewelry, while efficiently removing soil. The fill line of the liquid cleaner is below the bottom of the agitating chamber. A riser/drain feature supports the agitating chamber and allows the cleaning solution to flow into the agitating chamber during cleaning.

Order #	Description	Container Volume	12+	6+	1+
54-4520	Quick-Clean	8 oz	\$6.21	\$6.48	\$6.75



MYXIS SHINE BRITE

Formulated for repair facilities, yet safe enough for the retail market. Non-harmful, non-acidic, Shine Brite works remarkably well on the most difficult of jewelry such as mesh and rope chains, diamond bracelets and cluster rings, precious metals, and watch bands. Shine Brite dissolves dirt and grime away completely in warm water or light steam.

Order #	Description	Container Volume	12+	6+	1+
54-4478	Jewelry Cleaner	4 oz	\$3.53	\$3.83	\$4.25
54-4479	Jewelry Cleaner	8 oz	\$4.90	\$5.31	\$5.90

INSTA-CLEAN

A non-toxic dip or wipe-on tarnish remover and cleaner for gold, silver, copper, and brass.

Item	Order #	Container Volume	12+	6+	1+
A	54-4490	8 oz	\$4.72	\$5.00	\$5.55
B	54-4491	16 oz	\$6.89	\$7.47	\$8.30
C	54-4492	32 oz	\$11.04	\$11.97	\$13.30
D	54-4493	1 gallon	\$32.08	\$34.78	\$38.65



PR88 HAND PROTECTION

Excellent hand protection that will keep grease and grime from penetrating the skin. Just apply before beginning work. Washes off with soap and water.

Order #	Container Volume	12+	6+	1+
54-4462	3½ oz	\$9.06	\$9.46	\$9.85
54-4462	1 liter	\$27.92	\$29.14	\$30.35



BLUE MAGIC INVISIBLE GLOVE

Protective hand coating. Protects hands from rouge, grease, oil, and even paint. Easy clean-up with soap and water. Not greasy—actually improves grip on tools.

Order #	Container Volume	12+	6+	1+
54-4468	2½ oz	\$6.21	\$6.48	\$6.75



HAND CLEANER

A concentrated hand cleaner specifically designed for the jewelry industry. Contains very little grit with a citrus orange scent. This hand cleaner will remove all polish quickly and easily.

Item	Order #	Container Volume	12+	6+	1+
E	23-0065	1 gallon	\$20.65	\$21.55	\$22.45



PURE MAGIC

Cleans jewelry in 3 to 5 minutes regardless of how dirty. Just add water to the concentrated dry chemical mixture to obtain 32oz of full-strength cleaning solution.

Item	Order #	Container Volume	12+	6+	1+
F	54-4470	32 oz	\$13.48	\$14.06	\$14.65



STULLER TARNISH REMOVER

Dip and rinse to instantly remove tarnish from silver. Note: Ingredients deteriorate with use and can cause tarnish. Fresh solution corrects the problem.

Item	Order #	Container Volume	12+	6+	1+
G	54-4444	1 gallon	\$25.80	\$27.32	\$30.35



38¼" W × 18¼" L × 49¼" H
Double Faucet

FILTRATION SINK

Stuller's exclusive filtration sinks are a must have for your shop. Our single and double filtration sinks are made of stainless steel and each have a removable basin, which is light but durable. These sinks feature quality construction and up to 10 micron filtration at an affordable price.

One of the best ways to recover all the metal being washed away is with these 3 step filtration process. This is an easy to install filtration system taking less than 10 minutes for set up. Now you can stop washing away profits and save yourself the headache plumbing problems. The first step of the filtration process is a carpet filter, next the water will go through the decanting process, and last the water transfer. You can't go wrong with these easy installable filtration sinks.

3 FILTRATION STEPS

- 1 - CARPET FILTER
- 2 - DECANTING
- 3 - WATER TRANSFER

Recover metal with this easy-to-install triple water filtration system.



21¼" W × 18¼" L × 49¼" H
Single Faucet



View from above down into the basin, showing the filter.



Each sink has a removable basin which is light but durable.

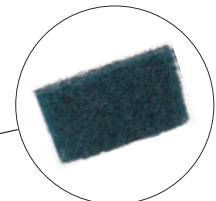
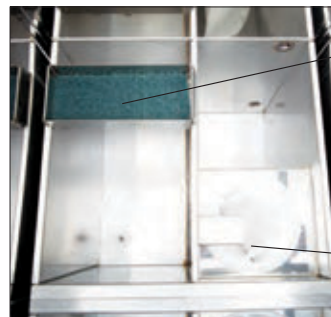

Carpet Filter



Bag Filter

Order #	Description	1+
23-6011	Double Faucet	\$2,600.00
23-6011	Single Faucet	\$1,900.00
REPLACEMENT PARTS		
23-6012	Bag Filter	\$31.95
23-6012	Carpet Filter	\$10.25

MAGIC DRAIN TRAP

See-thru trap can save all kinds of valuables. Easy, snap-off filter is easily removed to recover lost items. Magic drain is all plastic and resists corrosion. Easy to install. Hardware included.

Order #	Description	12+	6+	1+
23-6015	Magic Drain Trap	\$14.41	\$15.26	\$16.95



STONE SAVER

New style drain trap for jewelry trade shops. Made with fine mesh that prevents anything larger than 0.5 millimeters across from falling into the drain. Magnetic ring provides a secure seal to metal drains. Works with any standard 4½" metal sink drain. No installation required.

Order #	Description	12+	6+	1+
51-1000	Stone Saver™	\$11.36	\$11.86	\$12.35



ROUND SINK TRAP

This under counter sink trap is made from high density polyethylene with 3/8" uniform wall thickness and a removable polyethylene bucket and filter. It is designed for gravity drainage and is 100% corrosion proof seamless polyethylene construction. Made in the U.S.A.

Item	Order #	Description	Capacity	1+
A	23-6022	Top Access 1½" Pipe	1.2 gallon	\$356.00
	23-6022	Top Access with 2" Pipe	1.2 gallon	\$356.00
B	23-6023	Bottom Access 1½" Pipe	1.2 gallon	\$356.00
	23-6023	Bottom Access 2" Pipe	1.2 gallon	\$356.00



GOLD RECOVERY SYSTEM

Don't let money get washed down the drain. Install a drain sweeper kit under your sink and capture all your precious metal sweeps. The kit is easily installed with the included fittings and instructions—no need for a plumber in most cases. Catch particles as small as five microns. Filter cartridges are easily changed out in a matter of a couple minutes with no mess. This is a must-have for any repair room or manufacturing facility. Uses 1" inside diameter PVC pipe.

Item	Order #	Description	W × L	12+	6+	1+
C	23-6020	Drain Sweeper Kit	4½" × 13¾"	—	—	\$189.75
D	23-6021	Replacement Filter		\$5.91	\$6.26	\$6.95



Drills and Punches

HIGH-SPEED TWIST DRILLS

These high-speed drills are top-quality, precision-ground tempered steel. The drills are able to drill into metal as well as stone. A uniform, medium shank size speeds up tool changes.

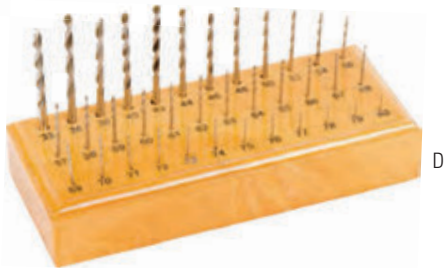
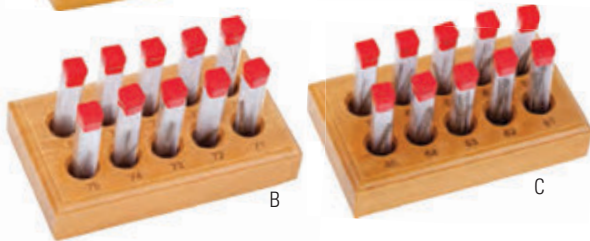

	Kit Order # 28-10000			
	A. Set of 200 (10 each) #61-80	B. Set of 100 (10 each) #71-80	C. Set of 100 (10 each) #61-70	D. Set of 36 (1 each) #33-80
12+	\$82.75	\$42.29	\$42.29	\$45.26
6+	\$86.35	\$45.86	\$45.86	\$47.23
1+	\$89.95	\$50.95	\$50.95	\$49.20

Order # 28-10000
 Material High Speed Steel
 Shank Size 3/32"
 Sold in packs of 10

	1.778mm	1.702mm	1.613mm	1.512mm	1.397mm	1.321mm	1.181mm	1.092mm
Drill #	#50	#51	#52	#53	#54	#55	#56	#57
12+	\$4.48	\$4.48	\$4.48	\$4.48	\$4.48	\$4.48	\$4.48	\$4.48
6+	\$5.04	\$5.04	\$5.04	\$5.04	\$5.04	\$5.04	\$5.04	\$5.04
1+	\$5.60	\$5.60	\$5.60	\$5.60	\$5.60	\$5.60	\$5.60	\$5.60

	1.067mm	1.041mm	1.016mm	0.99mm	0.965mm	0.94mm	0.914mm	0.889mm
Drill #	#58	#59	#60	#61	#62	#63	#64	#65
12+	\$4.48	\$4.48	\$4.48	\$4.48	\$4.48	\$4.48	\$4.48	\$4.48
6+	\$5.04	\$5.04	\$5.04	\$5.04	\$5.04	\$5.04	\$5.04	\$5.04
1+	\$5.60	\$5.60	\$5.60	\$5.60	\$5.60	\$5.60	\$5.60	\$5.60

	0.838mm	0.813mm	0.787mm	0.734mm	0.712mm	0.66mm	0.635mm	0.61mm
Drill #	#66	#67	#68	#69	#70	#71	#72	#73
12+	\$4.48	\$4.48	\$4.48	\$4.48	\$4.48	\$4.48	\$4.48	\$4.48
6+	\$5.04	\$5.04	\$5.04	\$5.04	\$5.04	\$5.04	\$5.04	\$5.04
1+	\$5.60	\$5.60	\$5.60	\$5.60	\$5.60	\$5.60	\$5.60	\$5.60

	0.572mm	0.533mm	0.508mm	0.457mm	0.406mm	0.369mm	0.343mm
Drill #	#74	#75	#76	#77	#78	#79	#80
12+	\$4.48	\$4.48	\$4.48	\$4.48	\$4.48	\$4.48	\$4.48
6+	\$5.04	\$5.04	\$5.04	\$5.04	\$5.04	\$5.04	\$5.04
1+	\$5.60	\$5.60	\$5.60	\$5.60	\$5.60	\$5.60	\$5.60



COBALT TWIST DRILLS



Order #	Kit Order # 28-0681		
	E. Set of 10 (1 each) 0.5mm–2.2mm		
Material	Cobalt Steel		
Shank Size	3/32"		
	Sold Each		
	12+	6+	1+
	\$37.27	\$39.47	\$43.85

	0.5mm	0.6mm	0.7mm	0.8mm	0.9mm	1mm	1.1mm	1.2mm
12+	\$4.29	\$4.29	\$4.29	\$4.29	\$4.29	\$4.29	\$4.29	\$4.29
6+	\$4.55	\$4.55	\$4.55	\$4.55	\$4.55	\$4.55	\$4.55	\$4.55
1+	\$5.05	\$5.05	\$5.05	\$5.05	\$5.05	\$5.05	\$5.05	\$5.05

	1.3mm	1.4mm	1.5mm	1.6mm	1.7mm	1.8mm	1.9mm	2mm
12+	\$4.29	\$4.29	\$4.29	\$4.29	\$4.29	\$4.29	\$4.29	\$4.29
6+	\$4.55	\$4.55	\$4.55	\$4.55	\$4.55	\$4.55	\$4.55	\$4.55
1+	\$5.05	\$5.05	\$5.05	\$5.05	\$5.05	\$5.05	\$5.05	\$5.05

	2.1mm	2.2mm	2.3mm
12+	\$4.29	\$4.29	\$4.29
6+	\$4.55	\$4.55	\$4.55
1+	\$5.05	\$5.05	\$5.05

Order #	28-10001	Kit Order # 28-10001		
Material	High Speed Steel	A. Set of 20 (1 each) #60-80		
Shank Size	3/32"	12+	6+	1+
	Sold in packs of 10	\$44.39	\$46.32	\$48.25

	1.78mm	1.7mm	1.51mm	1.397mm	1.18mm	1.092mm	1.067mm	1.041mm
Drill #	#50	#51	#52	#54	#55	#57	#58	#59
12+	\$17.53	\$17.53	\$17.53	\$17.53	\$17.53	\$17.53	\$17.53	\$17.53
6+	\$18.29	\$18.29	\$18.29	\$18.29	\$18.29	\$18.29	\$18.29	\$18.29
1+	\$19.05	\$19.05	\$19.05	\$19.05	\$19.05	\$19.05	\$19.05	\$19.05

	1.016mm	0.99mm	0.965mm	0.94mm	0.914mm	0.889mm	0.838mm	0.813mm
Drill #	#60	#61	#62	#63	#64	#65	#66	#67
12+	\$17.53	\$17.53	\$17.53	\$17.53	\$17.53	\$17.53	\$17.53	\$17.53
6+	\$18.29	\$18.29	\$18.29	\$18.29	\$18.29	\$18.29	\$18.29	\$18.29
1+	\$19.05	\$19.05	\$19.05	\$19.05	\$19.05	\$19.05	\$19.05	\$19.05

	0.787mm	0.734mm	0.713mm	0.66mm	0.635mm	0.61mm	0.572mm	0.533mm
Drill #	#68	#69	#70	#71	#72	#73	#74	#75
12+	\$17.53	\$19.60	\$19.60	\$22.68	\$22.68	\$22.68	\$22.68	\$22.68
6+	\$18.29	\$20.45	\$20.45	\$23.66	\$23.66	\$23.66	\$23.66	\$23.66
1+	\$19.05	\$21.30	\$21.30	\$24.65	\$24.65	\$24.65	\$24.65	\$24.65

	0.508mm	0.457mm	0.406mm	0.369mm	0.343mm
Drill #	#76	#77	#78	#79	#80
12+	\$22.68	\$22.68	\$27.83	\$27.83	\$27.83
6+	\$23.66	\$23.66	\$29.04	\$29.04	\$29.04
1+	\$24.65	\$24.65	\$30.25	\$30.25	\$30.25



DORMER, HIGH-SPEED, TWIST DRILLS
 Straight-shank, high-speed, steel twist drills. Made of high-quality steel. Last two digits equal drill number.



A



Order #	28-0682	Kit Order # 28-0682		
Material	Cobalt Steel	B. Set of 50 (5 each) #50, #53, #56, #57, #60, #64, #67, #70, #72, #76		
Shank Size	3/32"	12+	6+	1+
	Sold in packs of 5	\$50.75	\$55.04	\$61.15

	1.78mm	1.51mm	1.18mm	1.05mm	1.02mm	0.94mm	0.91mm	0.81mm
Drill #	#50	#53	#56	#57	#60	#63	#64	#67
12+	\$7.35	\$7.35	\$7.35	\$7.35	\$7.35	\$7.35	\$7.35	\$7.35
6+	\$7.79	\$7.79	\$7.79	\$7.79	\$7.79	\$7.79	\$7.79	\$7.79
1+	\$8.65	\$8.65	\$8.65	\$8.65	\$8.65	\$8.65	\$8.65	\$8.65

	0.91mm	0.74mm	0.71mm	0.64mm	0.61mm
Drill #	#64	#69	#70	#72	#73
12+	\$7.35	\$7.35	\$7.35	\$7.35	\$7.35
6+	\$7.79	\$7.79	\$7.79	\$7.79	\$7.79
1+	\$8.65	\$8.65	\$8.65	\$8.65	\$8.65



TITANIUM COATED TWIST DRILLS
 A professional and ideal solution to demanding drilling needs. The titanium coating allows the bits to withstand high temperatures by reducing friction. This leads to increased wear resistance.



B



PRIMO® HIGH SPEED TWIST DRILLS

HSS is the number one used drill in jewelry manufacturing. They are now available in standard 3/32" shank sizes.



Order # 10-8324
 Material Steel
 Shank Size 3/32"
 Sold in packs of 3

Kit Order # 10-8324		
10-Piece Assortment (1 each) .5mm-2.2mm		
12+	6+	1+
\$23.41	\$24.43	\$25.45

	0.5mm	0.7mm	0.9mm	1.1mm	1.2mm	1.4mm	1.6mm	1.8mm	2mm	2.2mm
Drill #	#76	#70	#65	#57	#56	#54	#52	#50	#46	#43
12+	\$7.31	\$7.31	\$7.31	\$7.31	\$7.31	\$7.31	\$7.31	\$7.31	\$7.31	\$7.31
6+	\$7.63	\$7.63	\$7.63	\$7.63	\$7.63	\$7.63	\$7.63	\$7.63	\$7.63	\$7.63
1+	\$7.95	\$7.95	\$7.95	\$7.95	\$7.95	\$7.95	\$7.95	\$7.95	\$7.95	\$7.95



PRIMO® HIGH SPEED TITANIUM COATED TWIST DRILLS

Titanium coated drills last 4-5 times longer than non-coated drills. Coated drills provide smoother drilling and run cooler due to less friction.

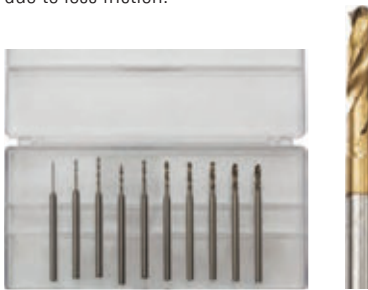

Order # 10-8325
 Material Steel
 Shank Size 3/32"
 Sold in packs of 3

Kit Order # 10-8325		
10-Piece Assortment (1 each) .5mm-2.2mm		
12+	6+	1+
\$8.14	\$8.50	\$8.85

	0.5mm	0.7mm	0.9mm	1.1mm	1.2mm	1.4mm	1.6mm	1.8mm	2mm	2.2mm
Drill #	#76	#70	#65	#57	#56	#54	#52	#50	#46	#43
12+	\$8.14	\$8.14	\$8.14	\$8.14	\$8.14	\$8.14	\$8.14	\$8.14	\$8.14	\$8.14
6+	\$8.50	\$8.50	\$8.50	\$8.50	\$8.50	\$8.50	\$8.50	\$8.50	\$8.50	\$8.50
1+	\$8.85	\$8.85	\$8.85	\$8.85	\$8.85	\$8.85	\$8.85	\$8.85	\$8.85	\$8.85



PRIMO® HIGH SPEED STEEL JOBBER TITANIUM COATED TWIST DRILLS

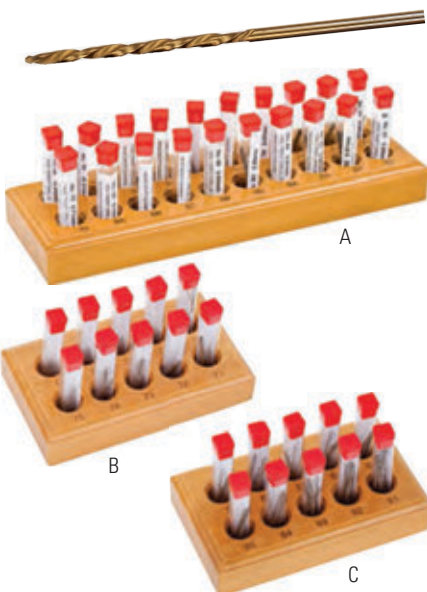

Order # 10-8330
 Material Steel
 Shank Size 3/32"
 Sold Each

Kit Order # 10-8330		
A. Set of 100 (5 each) #61-80	B. Set of 50 (5 each) #61-70	C. Set of 50 (5 each) #71-80
12+	\$71.81	\$37.81
6+	\$74.93	\$39.46
1+	\$78.05	\$41.10

	0.99mm	0.97mm	0.94mm	0.91mm	0.89mm	0.84mm	0.81mm	0.79mm	0.73mm	0.71mm
Drill #	#61	#64	#63	#64	#65	#66	#67	#68	#69	#70
12+	\$6.35	\$6.35	\$6.35	\$6.35	\$6.35	\$6.35	\$6.35	\$6.35	\$6.35	\$6.35
6+	\$6.62	\$6.62	\$6.62	\$6.62	\$6.62	\$6.62	\$6.62	\$6.62	\$6.62	\$6.62
1+	\$6.90	\$6.90	\$6.90	\$6.90	\$6.90	\$6.90	\$6.90	\$6.90	\$6.90	\$6.90

	0.66mm	0.64mm	0.61mm	0.57mm	0.53mm	0.51mm	0.46mm	0.41mm	0.37mm	0.34mm
Drill #	#71	#72	#73	#74	#74	#76	#77	#78	#79	#80
12+	\$6.35	\$6.35	\$6.35	\$6.35	\$6.35	\$6.35	\$6.35	\$6.35	\$6.35	\$6.35
6+	\$6.62	\$6.62	\$6.62	\$6.62	\$6.62	\$6.62	\$6.62	\$6.62	\$6.62	\$6.62
1+	\$6.90	\$6.90	\$6.90	\$6.90	\$6.90	\$6.90	\$6.90	\$6.90	\$6.90	\$6.90



Order # 28-0683

Material Cobalt
Shank Size 3/32"
Sold in packs of 10

Kit Order # 28-0683	
50-Piece Assortment: #50, #53, #56, #57, #60 #64, #67, #70, #72, #76	50-Piece Assortment: #71-#80
12+	\$65.16
6+	\$70.65
1+	\$78.50

PRIMO® COBALT MINI TWIST DRILLS

- Accurately ground for precise drilling
- 10 most popular drill sizes offered
- Extended life compared to Vanadium drills

	1.78mm	1.7mm	1.61mm	1.51mm	1.4mm	1.32mm	1.18mm	1.09mm	1.07mm	1.04mm	1.02mm
Drill #	#50	#51	#52	#53	#54	#55	#56	#57	#58	#59	#60
12+	\$7.32	\$7.32	\$7.32	\$7.32	\$7.32	\$7.32	\$7.32	\$7.32	\$7.32	\$7.32	\$7.32
6+	\$8.24	\$8.24	\$8.24	\$8.24	\$8.24	\$8.24	\$8.24	\$8.24	\$8.24	\$8.24	\$8.24
1+	\$9.15	\$9.15	\$9.15	\$9.15	\$9.15	\$9.15	\$9.15	\$9.15	\$9.15	\$9.15	\$9.15

	0.99mm	0.97mm	0.94mm	0.91mm	0.89mm	0.84mm	0.81mm	0.79mm	0.73mm	0.71mm
Drill #	#61	#62	#63	#64	#65	#66	#67	#68	#69	#70
12+	\$7.32	\$7.32	\$7.32	\$7.32	\$7.32	\$7.32	\$7.32	\$7.32	\$7.32	\$7.32
6+	\$8.24	\$8.24	\$8.24	\$8.24	\$8.24	\$8.24	\$8.24	\$8.24	\$8.24	\$8.24
1+	\$9.15	\$9.15	\$9.15	\$9.15	\$9.15	\$9.15	\$9.15	\$9.15	\$9.15	\$9.15

	0.66mm	0.61mm	0.64mm	0.57mm	0.53mm	0.52mm	0.46mm	0.41mm	0.37mm	0.34mm
Drill #	#71	#73	#74	#74	#75	#76	#77	#78	#79	#80
12+	\$7.32	\$7.32	\$7.32	\$7.32	\$7.32	\$7.32	\$7.32	\$7.32	\$7.32	\$7.32
6+	\$8.24	\$8.24	\$8.24	\$8.24	\$8.24	\$8.24	\$8.24	\$8.24	\$8.24	\$8.24
1+	\$9.15	\$9.15	\$9.15	\$9.15	\$9.15	\$9.15	\$9.15	\$9.15	\$9.15	\$9.15



Order # 77-2507

Material Steel
Shank Size 3/32"
Sold in packs of 5

Kit Order # 77-2507		
30-Piece Assortment (3 each)		
12+	6+	1+
\$7.27	\$7.70	\$8.55

PRIMO® DIAMOND COATED MINI TWIST DRILLS

	2.71mm	2.49mm	2.08mm	1.99mm	1.78mm	1.7mm	1.61mm	1.51mm
Drill #	#36	#40	#45	#47	#50	#51	#52	#53
12+	\$7.27	\$7.27	\$7.27	\$7.27	\$7.27	\$7.27	\$7.27	\$7.27
6+	\$7.70	\$7.70	\$7.70	\$7.70	\$7.70	\$7.70	\$7.70	\$7.70
1+	\$8.55	\$8.55	\$8.55	\$8.55	\$8.55	\$8.55	\$8.55	\$8.55

	1.4mm	1.18mm	0.99mm	0.89mm
Drill #	#54	#56	#61	#65
12+	\$7.27	\$7.27	\$7.27	\$7.27
6+	\$7.70	\$7.70	\$7.70	\$7.70
1+	\$8.55	\$8.55	\$8.55	\$8.55



Drills and Punches

PRIMO® COBALT PILOT TWIST DRILL ASSORTMENT

Solid cobalt, double ended pilot drills provide an optimal pinpoint location to mark the area to be drilled.



Order #	Description	12+	6+	1+
10-8326	Pilot Twist Drill Assortment (0.5mm, 1.0mm, 1.5mm)	\$15.50	\$16.18	\$16.85





Swiss-made medium-fine grit twist drills are the ultimate for drilling stones, pearls, glass, or ceramics. Use with standard handpieces and a small amount of water as lubricant.

PANTHER DIAMOND TWIST DRILL, FIG. #77D



Order # 28-10002

Material Tungsten Carbide Steel
 Shank Size 3/32"
 Sold in packs of 6

	0.8mm	0.9mm	1mm	1.2mm	1.4mm
Drill #	#008	#009	#010	#012	#014
12+	\$58.65	\$58.65	\$58.65	\$58.65	\$58.65
6+	\$61.20	\$61.20	\$61.20	\$61.20	\$61.20
1+	\$63.75	\$63.75	\$63.75	\$63.75	\$63.75



PANTHER STAINLESS STEEL TWIST DRILL, FIG. #77



Order # 28-10003

Material Stainless Steel
 Shank Size 3/32"
 Sold in packs of 6

	0.5mm	0.6mm	0.7mm	0.8mm	0.9mm	1mm	1.1mm	1.2mm	1.3mm	.50-1.6mm
Drill #	#005	#006	#007	#008	#009	#010	#011	#012	#013	#005-016
12+	\$7.47	\$7.47	\$7.47	\$7.47	\$7.47	\$7.47	\$7.47	\$7.47	\$7.47	\$16.41
6+	\$8.10	\$8.10	\$8.10	\$8.10	\$8.10	\$8.10	\$8.10	\$8.10	\$8.10	\$17.37
1+	\$9.00	\$9.00	\$9.00	\$9.00	\$9.00	\$9.00	\$9.00	\$9.00	\$9.00	\$19.30

	1.5mm	1.6mm	1.7mm	1.8mm	1.9mm	2mm	2.1mm	2.2mm	2.3mm
Drill #	#015	#016	#017	#018	#019	#020	#021	#022	#023
12+	\$37.90	\$37.90	\$37.90	\$37.90	\$37.90	\$37.90	\$37.90	\$37.90	\$37.90
6+	\$39.55	\$39.55	\$39.55	\$39.55	\$39.55	\$39.55	\$39.55	\$39.55	\$39.55
1+	\$41.20	\$41.20	\$41.20	\$41.20	\$41.20	\$41.20	\$41.20	\$41.20	\$41.20



PANTHER TUNGSTEN CARBIDE TWIST DRILL, FIG. #H203



Order # 28-10004

Material Tungsten Carbide Steel
 Shank Size 3/32"
 Sold in packs of 6

	0.5mm	0.6mm	0.7mm	0.8mm	0.9mm	1mm	1.1mm	1.2mm	1.3mm	1.4mm
Drill #	#005	#006	#007	#008	#009	#010	#011	#012	#013	#014
12+	\$37.90	\$37.90	\$37.90	\$37.90	\$37.90	\$37.90	\$37.90	\$37.90	\$37.90	\$37.90
6+	\$39.55	\$39.55	\$39.55	\$39.55	\$39.55	\$39.55	\$39.55	\$39.55	\$39.55	\$39.55
1+	\$41.20	\$41.20	\$41.20	\$41.20	\$41.20	\$41.20	\$41.20	\$41.20	\$41.20	\$41.20

	1.5mm	1.6mm	1.7mm	1.8mm	1.9mm	2mm	2.1mm	2.2mm	2.3mm
Drill #	#015	#016	#017	#018	#019	#020	#021	#022	#023
12+	\$37.90	\$37.90	\$37.90	\$37.90	\$37.90	\$37.90	\$37.90	\$37.90	\$37.90
6+	\$39.55	\$39.55	\$39.55	\$39.55	\$39.55	\$39.55	\$39.55	\$39.55	\$39.55
1+	\$41.20	\$41.20	\$41.20	\$41.20	\$41.20	\$41.20	\$41.20	\$41.20	\$41.20





Order # 28-10005

Material Tungsten Vanadium Steel
 Shank Size 3/32"
 Sold in packs of 6

	0.5mm	0.6mm	0.7mm	0.8mm	0.9mm	1mm	1.1mm
12+	\$14.86	\$14.86	\$14.86	\$14.86	\$14.86	\$14.86	\$14.86
6+	\$15.50	\$15.50	\$15.50	\$15.50	\$15.50	\$15.50	\$15.50
1+	\$16.15	\$16.15	\$16.15	\$16.15	\$16.15	\$16.15	\$16.15

	1.2mm	1.4mm	1.5mm	1.6mm	1.8mm	1.9mm
12+	\$14.86	\$14.86	\$14.86	\$14.86	\$14.86	\$14.86
6+	\$15.50	\$15.50	\$15.50	\$15.50	\$15.50	\$15.50
1+	\$16.15	\$16.15	\$16.15	\$16.15	\$16.15	\$16.15



BUSCH® TUNGSTEN VANADIUM STEEL DRILLS

Tungsten vanadium steel makes drills both tougher and harder. Only a small amount of vanadium is needed to increase the hardness, strength, and high temperature stability of steel.

Order # 28-10006

Material Stainless Steel
 Shank Size 3/32"
 Sold Each

	1.5mm	2.5mm	3mm	4mm	5mm	2mm
12+	\$5.66	\$5.10	\$5.10	\$5.66	\$5.66	\$5.66
6+	\$5.90	\$5.54	\$5.54	\$5.90	\$5.90	\$5.90
1+	\$6.15	\$6.15	\$6.15	\$6.15	\$6.15	\$6.15

Technical Note: Always use a lubricant or water when working with diamond coated instruments

DIAMOND-COATED CORE DRILLS

Used to cut holes in ceramics, tile, and glass without chipping or cracking. Shanks are 3mm, medium-fine grit and are made of stainless steel with electroplated diamond particles.



Order # 28-1000

Material High Speed Steel
 Shank Size 3/32"
 Sold Each

Kit Order # 28-1000			
A. Set of 6 (1 each) 1.0mm, 1.3mm, 1.4mm, 1.6mm, 1.8mm, 2.1mm			
	12+	6+	1+
	\$17.96	\$20.20	\$22.45

	0.7mm	0.8mm	0.9mm	1mm	1.1mm	1.2mm	1.3mm	1.4mm
12+	\$5.01	\$5.01	\$5.01	\$5.01	\$5.01	\$5.01	\$5.01	\$5.01
6+	\$5.31	\$5.31	\$5.31	\$5.31	\$5.31	\$5.31	\$5.31	\$5.31
1+	\$5.90	\$5.90	\$5.90	\$5.90	\$5.90	\$5.90	\$5.90	\$5.90

	1.5mm	1.6mm	1.7mm	1.8mm	1.9mm	2mm	2.1mm
12+	\$5.01	\$5.01	\$5.01	\$5.01	\$5.01	\$5.01	\$5.01
6+	\$5.31	\$5.31	\$5.31	\$5.31	\$5.31	\$5.31	\$5.31
1+	\$5.90	\$5.90	\$5.90	\$5.90	\$5.90	\$5.90	\$5.90

DIAMOND-COATED TWIST DRILLS

Use to drill stones, glass, pearls and ceramics. Diamond is evenly plated on High Speed Steel blanks for maximum life. Medium/Fine grit. Always use a small amount of water or coolant when drilling for longer drill life and faster cutting. Wear safety glasses.

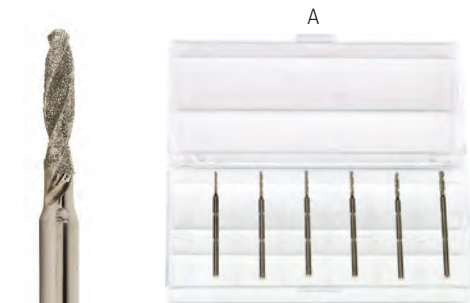

Drills and Punches



BENCH TOP DRILL PRESS

A. This new, easy-to-use bench top drill press is tiny, but powerful enough to use for all of your drilling projects. With a platform measuring only 6¾" x 6¾", it is space saving as well as economical.

- 110-120V - Accepts ⅛" to ¼" drills - 100 Watts

B. Superlube is a multi-purpose synthetic non-toxic, non-polluting, and non-corrosive lubricant with Teflon particles. It does not harm plastic.

Item	Order #	Description	Size	12+	6+	1+
A	28-0686	Bench Top Drill Press		\$63.75	\$67.50	\$75.00
B	26-3879	Synthetic Lubricant	¼ oz	—	—	\$9.05

FOREDOM®



FOREDOM® DRILL PRESS

A rugged and precise stand that converts your flexible shaft unit into a precision drill press and milling tool. The sturdy, all-metal stand is fully adjustable, has a 2" throat capacity, and a stroke length of up to 1¼". The work holding table moves up and down or can be swung away for drilling large pieces. Designed for use with No. 30, No. 30H, No. 44, No. 44T, and No. 44HT handpieces. The DP39 comes with a dial indicator measuring in millimeters for setting, drilling, or cutting depth. Graduated by 1/100 mm.

Item	Order #	Description	12+	6+	1+
C	34-6302	DP30 Drill Press	\$149.43	\$158.22	\$175.80



FOREDOM® MINI VISE

Zinc, die-cast, mini vise firmly grasps small work pieces for precision drilling. Has horizontal and vertical "V" grooves for holding small round pieces. Use with DP30, item 34-6302.

Item	Order #	Description	Width	ID	12+	6+	1+
D	34-6301	Metal Vise	1¾"	1¼"	\$21.25	\$22.50	\$25.00



FOREDOM® DRILL VISE

Plastic mini vise is great for holding gemstones and other materials that require water during the drilling process.

Item	Order #	Description	Width	ID	12+	6+	1+
E	58-2434	Drill Vise	¾"	1½"	\$16.83	\$17.82	\$19.80



412 SLICK LUBE

The most advanced coolant in the market today. The 100% synthetic polymer coolant is a unique blend of wetting agents, lubricants, and rust inhibitors. Excellent for drilling and cutting. Contains no nitrosamines, phenols, nitrates, sulphur, chlorine, phosphates, or oil. It controls dermatitis with the addition of skin conditioners. Keeps machinery and work cleaner and has excellent rust prevention properties. Concentrate mixes 10:1.

Order #	Container Volume	12+	6+	1+
26-1003	16 oz bottle	\$10.50	\$11.12	\$12.35

COMBINATION CENTERING AND RIVETING PUNCH

Allows automatic stroke. Adjustable for light, medium, or heavy impressions. Fitted with centering point. Also shipped with cup and flat points for riveting and burnishing.

Item	Order #	Description	12+	6+	1+
A	47-8002	Centering and Riveting Punch	\$21.89	\$23.18	\$25.75



DOUBLE-ENDED, PIN VISE

Each end contains reversible, steel collets. Rolling prevented by hexagonal head. Hollow handle and heads are made of brass.

Item	Order #	Capacity	Length	12+	6+	1+
B	58-2400	0 – 3.2mm	4"	\$4.89	\$5.18	\$5.75



AUTOMATIC CENTER PUNCH

Punches, marks, and scribes. Lightweight aluminum body with replaceable steel point for long wear. Adjusts for light or heavy markings. Pencil-slim design with pocket clip.

Item	Order #	Description	Length	12+	6+	1+
C	47-8014	Center Punch	7"	\$14.88	\$15.75	\$17.50



PIN SLIDE

Easy to operate with one hand due to knurled ring which slides forward to close steel jaws. Hollow handle.

Item	Order #	Capacity	Length	12+	6+	1+
D	58-2410	0 – 1.3mm	4 1/8"	\$9.61	\$10.17	\$11.30



PIN VISE WITH SQUARE CHUCK

Used to hold small drills, wire, taps, screwdriver blades, and more.

Item	Order #	Capacity	Length	12+	6+	1+
E	58-2450	0 – 2mm	3"	\$6.46	\$6.84	\$7.60
F	58-2452	0 – 2mm	4 1/4"	\$7.65	\$8.10	\$9.00
G	58-2454	0 – 2mm	4 3/4"	\$7.86	\$8.32	\$9.25
H	58-2456	0 – 2mm	5"	\$8.37	\$8.87	\$9.85

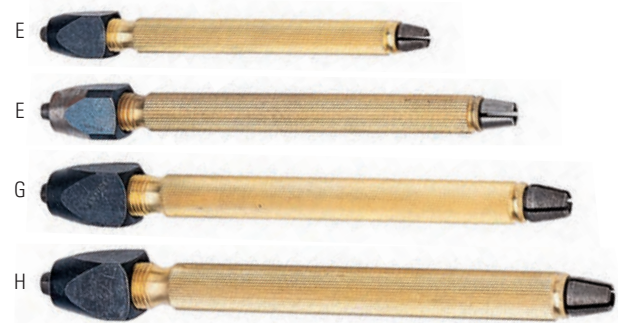

WING-NUT, HAND VISE

Used in holding small drills, wire, taps, screwdriver blades, and more. Hollow handles allow long wire to pass through. Jaws have spring action, and are serrated and grooved. Open and close with large wing nut.

Item	Order #	Length	Width	Jaw Opening	12+	6+	1+
J	58-1400	4 1/2"	5/8"	1/4"	\$24.82	\$26.28	\$29.20



SWIVEL PIN VISE

Used for drilling or tapping. Contains two, double-ended chucks.

Item	Order #	Capacity	Length	12+	6+	1+
K	58-2200	0 – 3.3mm	4"	\$4.38	\$4.64	\$5.15



Drills and Punches



GRS® HAND CHUCK

This precision hand chuck holds a variety of tools including many gravers. Its two-jaw chuck is made of hardened and ground steel with a v-notch in each jaw for superior grip. Extremely versatile, comfortable shape and size.

Item	Order #	Opening	Length	1+
A	26-4039	1.5mm	2"	\$33.80



SWIVEL TOOL HANDLE

Used for drilling, reaming, and other applications. The barrel turns by twisting the knurled collar. Holds earring while setting.

Item	Order #	Opening	Length	12+	6+	1+
B	37-9000	1.5mm	4"	\$13.18	\$13.95	\$15.50



ADAPTER CHUCKS

Allows small drills to be adapted to larger chucks or flex shaft handpieces.

Item	Order #	Description	Capacity	Collet Size	12+	6+	1+
C	28-2115	1 collet	1.15mm	3/32"	\$6.33	\$6.71	\$7.45
	28-2116	2 collets	2.5mm	3/32"	\$10.03	\$10.62	\$11.80



MICRO CHUCK

For use with #70 and #80 drills.

Item	Order #	Opening	Shank Size	12+	6+	1+
D	28-2118	1.5mm	3/32"	\$4.23	\$4.42	\$4.60

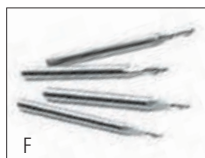

PREFORM DRILL PRESS

The drill press is used to center and guide the drill bit when preparing the mounting to accept the Preform Stock. Designed to work with all five sizes of mill bits. Handpiece sold separately.

Item	Order #	Description	OD	12+	6+	1+
E	48-1036	Preform Drill Press		—	—	\$155.00
F	48-1046	Drill Kit		\$57.33	\$60.71	\$67.45



INDIVIDUAL DRILLS

Item	Order #	Description	OD	12+	6+	1+
G	48-1048	Carbide End Mill Drill	1mm	\$17.57	\$18.34	\$19.10
H	48-1047	Carbide End Mill Drill	1.2mm	\$17.57	\$18.34	\$19.10
J	48-1043	Carbide End Mill Drill	1.5mm	\$17.57	\$18.34	\$19.10
K	48-1044	Carbide End Mill Drill	1.75mm	\$17.57	\$18.34	\$19.10
L	48-1045	Carbide End Mill Drill	2mm	\$17.57	\$18.34	\$19.10



PEARL HOLDING VISE

Holds pearls securely for drilling. 13 holes (2-10mm).

Item	Order #	Description	12+	6+	1+
M	53-1203	Pearl Holding Vise	\$5.53	\$5.85	\$6.50

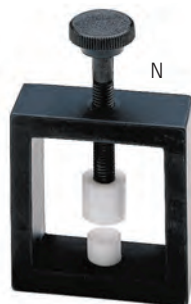

PEARL DRILL VISE

Holds pearls in place while drilling. Allows you to half-drill pearls and beads or open obstructed or imperfect holes. Features a 1mm, drill guide (#60 drill).

Item	Order #	Description	12+	6+	1+
N	53-1201	Pearl Drill Vise	\$16.15	\$17.10	\$19.00



A

SET OF PEARL DRILLS

Used to drill holes in seed pearls and round and half-round stones to aid in the setting process.

Item	Order #	Outside Diameter	12+	6+	1+
A	53-1200	1.0mm-3.0mm Pearl Drill Set	\$75.07	\$78.34	\$81.60

INDIVIDUAL DRILLS

53-1206	1.05mm	\$6.12	\$6.38	\$6.65
53-1207	1.2mm	\$6.12	\$6.38	\$6.65
53-1208	1.45mm	\$6.12	\$6.38	\$6.65
53-1209	1.65mm	\$6.12	\$6.38	\$6.65
53-1210	1.85mm	\$6.12	\$6.38	\$6.65
53-1211	2.05mm	\$6.12	\$6.38	\$6.65
53-1212	2.26mm	\$6.12	\$6.38	\$6.65
53-1213	2.4mm	\$6.12	\$6.38	\$6.65
53-1216	3mm	\$6.12	\$6.38	\$6.65

HIGH-SPEED PEARL DRILLS

High speed pearl drills are double ended. They are specially shaped to drill an accurate hole without chipping.



Order #	Outside Diameter	12+	6+	1+
28-0730	0.6mm	\$4.80	\$5.09	\$5.65
28-0731	0.7mm	\$4.80	\$5.09	\$5.65
28-0732	0.8mm	\$4.80	\$5.09	\$5.65
28-0733	0.9mm	\$4.80	\$5.09	\$5.65
28-0734	1mm	\$4.80	\$5.09	\$5.65
28-0736	1.2mm	\$4.80	\$5.09	\$5.65
28-0737	1.3mm	\$4.80	\$5.09	\$5.65
28-0738	1.4mm	\$14.49	\$15.12	\$15.75
28-0739	1.5mm	\$14.49	\$15.12	\$15.75
28-0740	1.6mm	\$14.49	\$15.12	\$15.75
28-0741	1.7mm	\$20.65	\$21.55	\$22.45



BUSCH® PEARL DRILLS

For drilling holes in pearls and other round to half-round stones for stone setting. 3/32" shank.

Order #	OD	12+	6+	1+	Order #	OD	12+	6+	1+
28-0751	0.9mm	\$4.42	\$4.68	\$5.20	28-0755	1.6mm	\$4.42	\$4.68	\$5.20
28-0752	1mm	\$4.42	\$4.68	\$5.20	28-0757	2.1mm	\$4.42	\$4.68	\$5.20
28-0753	1.2mm	\$4.42	\$4.68	\$5.20	28-0758	2.3mm	\$4.42	\$4.68	\$5.20
28-0754	1.4mm	\$4.42	\$4.68	\$5.20	28-0759	2.5mm	\$4.78	\$4.99	\$5.20



B

C

D

PEARL DRILL MACHINE

High-precision drill, specifically designed to drill pearls from 3mm to 20mm without any chipping or cracking of the pearls. The compact unit includes a drill chuck, a self-centering vise to hold the pearls securely while drilling, and a 6,000 RPM motor. Comes with brass pearl holders from 3mm to 7mm.

Item	Order #	Description	Outside Diameter	1+
B	28-0700	Pearl Drilling Machine		\$842.70

REPLACEMENT PARTS

C	28-0705	Carbon Brush/Caps		\$13.05
D	28-0711	Brass Holder (pair)	6mm	\$37.05
	28-0712	Brass Holder (pair)	7mm	\$37.05
	28-0713	Brass Holder (pair)	8mm	\$37.05
	28-0714	Brass Holder (pair)	9mm	\$37.05
	28-0715	Brass Holder (pair)	10mm	\$45.85
	28-0716	Brass Holder (pair)	11mm	\$45.85
	28-0717	Brass Holder (pair)	12mm	\$45.85
	28-0718	Brass Holder (pair)	13mm	\$45.85
	28-0719	Brass Holder (pair)	14mm	\$45.85
	28-0720	Brass Holder (pair)	15mm	\$45.85
	28-0721	Brass Holder (pair)	16mm	\$45.85
	28-0722	Brass Holder (pair)	17mm	\$51.95
	28-0723	Brass Holder (pair)	18mm	\$51.95
	28-0724	Brass Holder (pair)	19mm	\$51.95
	28-0725	Brass Holder (pair)	20mm	\$51.95

EASY JEWEL IV
 Advanced laser technology and marking software enable new applications and bring laser marketing and engraving to the highest standards. The new EasyJewel with 'Enhanced Mode' has been especially designed for circumferential seamless design and large components requiring uniform surfaces.

JEWELRY MARKING MADE EASY

Typical jewelry marking tasks are handled effortlessly with perfect results. Thanks to numerous innovations, even inside marking of wide or special shape rings is now easily achieved. The sophisticated marking software automatically makes geometrical corrections due to the non-perpendicular approach to the marking area. Large markings can be executed with the help of an auto-tilting function. Within minutes the system is retooled for marking flat parts.

Based on advanced completely air cooling technology. As an all-in-one laser marking solution with compact design, the system is portable. The 100V – 240V connection ensures quick and easy initial operation without requiring any additional device like for example an external cooling. A special safety feature is the enclosed marking area (laser class 1). Wearing laser safety goggles is thus not necessary, a fact which enhances operator convenience.

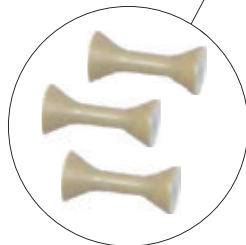

Easy Jewel Pins

176 lbs

- Bench-top laser marking system for jewelry manufacturing
- Advanced laser technology
- Engrave inside and outside rings
- Engrave flat, irregular, and unique shapes

Order #	Description	1+
14-0146	Easy Jewel IV 50F Fiber Laser Engraver	\$96,700.00
14-0146	Easy Jewel IV 30F Fiber Laser Engraver	\$79,900.00
14-0146	Easy Jewel IV 20F Fiber Laser Engraver	\$69,900.00
14-0146	Easy Jewel IV 10E Laser Engraver	\$59,900.00

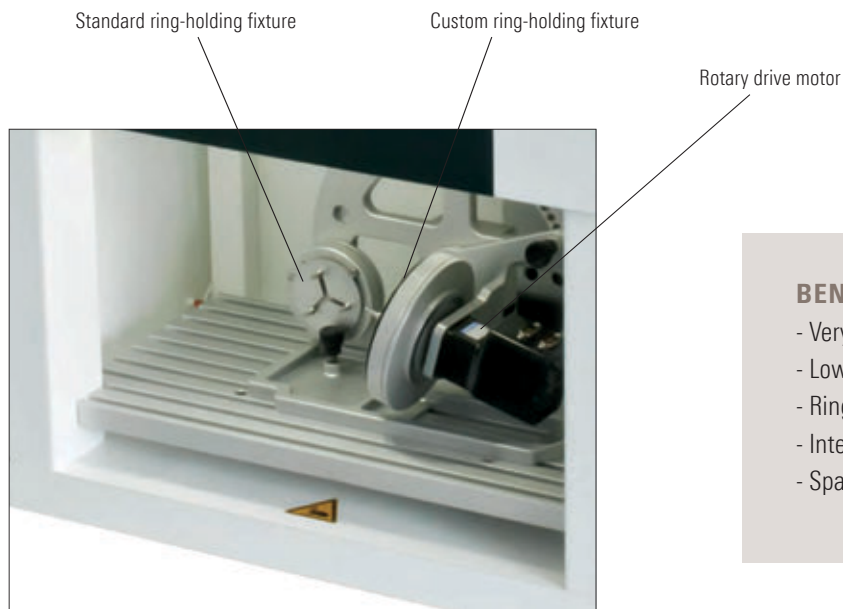

BENEFITS

- Very easy operation using graphical interface
- Low maintenance and service costs
- Ring marking module-patent pending
- Integrated air cooling
- Spacious working Chamber

- Quick and exact loading of regular and special shapes. One fixture for inside, and outside marking
- Precise jogging function to reach optimum marking position. Software auto-correction, auto-tiling
- Live preview with real time color camera
- Task-oriented, efficient job definition by entering part and material parameters
- Ships direct from factory

EASY JEWEL IV ACCESSORIES

Item	Order #	Description	1+
A	14-0148	Chuck, Symmetric Ring (standard)	\$2,156.00
B	14-0148	Chuck, Symmetric Ring (custom)	\$1,114.00
C	14-0149	Centering Fixture	\$2,023.00
D	14-0147	Support Flange M/MTR	\$446.00
E	14-0153	Rotary Cam Centering Plate	\$376.00
F	14-0150	Flapper for Centering Tool	\$83.00
G	14-0155	Replacement Flat Marking Angle Plate (2 required)	\$114.00
H	14-0154	Replacement Spring for Chuck, Symmetric	\$9.00
J	14-0151	Pin, 13.9mm Conical (3 each required)	\$67.00
	14-0151	Pin, 8.9mm Conical (3 each required)	\$25.00
	14-0151	Pin, 15.0mm Cylindrical (3 each required)	\$29.00
	14-0151	Pin, 8.0mm Cylindrical (3 each required)	\$29.00
	14-0151	Pin, 11.4mm Conical (3 each required)	\$67.00



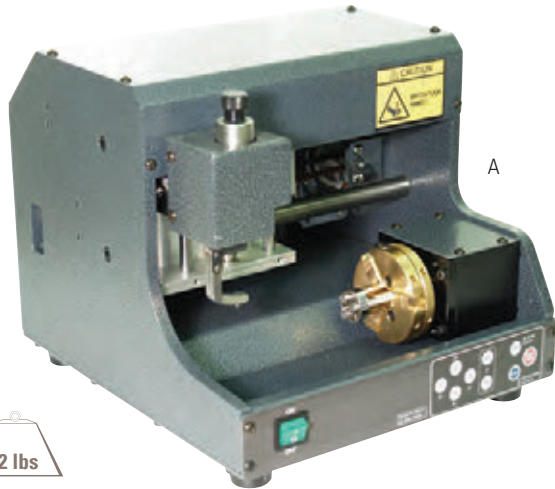

42 lbs

The Best Built Inside Ring Engraver can perform tasks that were previously impossible on a traditional engraver such as: Engrave on the outside of rings, easily engrave perfectly spaced multiple lines on either the inside or outside of rings, and automatically engrave any logos or artwork your customers request!

BEST BUILT INSIDE RING ENGRAVER

A compact and quiet computerized system for engraving the inside and outside of flat of slightly domed rings, perfect for use in small stores and shops: Features intuitive software that lets you use your own PC fonts or designs for engraving, all necessary work piece fixtures, focused LED (like a laser) for precise work piece alignment, variable depth adjustment and automatic surface slope checker for uneven surfaces, and an easily replaceable diamond tip.

- Includes USB cable
- Speed up or slow down the process at the press of a button
- Do single-line, double-line and hatching-style engraving (a unique shading effect made by drawing parallel lines closely together)
- Individually assign different tool paths (e.g., double-line letter followed by hatching-style letter)
- Easily convert and engrave JPEG and BMP images

Specifications:

- Engraves rings only
- Dual voltage 110/220V
- 10¹/₈" W x 11¹/₄" L x 9¹/₄" H
- 42 lbs.

Item	Order #	Description	W x L x H	1+
A	26-3922	Inside Ring Engraver	10 ¹ / ₈ " x 11 ¹ / ₄ " x 9 ¹ / ₄ "	\$2,395.00

See next page for Replacement Diamond Tips (26-3923).



48 lbs

BEST BUILT FLAT ENGRAVER

Best Built computerized flat engraver is quiet used directly for engraving on flat surfaces. This engraver is used for award plaques and plates, memorial plates, etc. It is perfect for use in small stores and shops. This computerized engraver features intuitive software that lets you use your own PC fonts or designs for engraving, all necessary work piece fixtures, focused LED (like a laser) for precise work piece alignment, variable depth adjustment and automatic surface slope checker for uneven surfaces, and an easily replaceable diamond tip.

- Includes USB cable
- Speed up or slow down the process at the press of a button
- Do single-line, double-line and hatching-style engraving (a unique shading effect made by drawing - parallel lines closely together)
- Individually assign different tool paths (e.g., double-line letter followed by hatching-style letter)
- Easily convert and engrave JPEG and BMP images

Specifications:

- Engraves flat surfaces
- 110V
- Maximum engraving area 4" x 4¹/₂"
- 12³/₄" W x 10¹/₄" L x 9¹/₄" H
- 52 lbs.

Item	Order #	Description	W x L x H	1+
B	26-3921	Flat Engraver	12 ³ / ₄ " x 10 ¹ / ₄ " x 9 ¹ / ₄ "	\$3,495.00
	26-3921	120° Diamond Tip For UT- 120		\$35.00
	26-3921	90° Diamond Tip For UT- 20		\$35.00



90° Diamond Tip For UT- 20



120° Diamond Tip For UT- 120

BEST BUILT DUAL COMPUTERIZED ENGRAVERS

These engravers combine the style and accuracy of traditional diamond engraving with the endless possibilities of a Windows-based software system. This multi-functioning engraver fits the need of all types of jewelers and hobbyists. With the press of a button, engrave or mill on top of the ring using the built-in rotary vise. Engrave inside the ring with the included ring engraving tip attachment. Features:

- Variable depth adjustment and automatic surface slope checker for uneven surfaces such as bracelets
- Cut name plate jewelry
- Engraves deep enough for enamel inlay
- Engrave bangle bracelets
- Precious metal cutting bits
- Five automatic sensors
- Laser pointer
- Engrave or cut precious metal or acrylic
- Flat surface engraving area is 4" x 4 1/2"
- 15 1/4" W x 13 1/4" L x 12 1/4" H
- 100-240 Volts, 50/60 Hz
- 80 lbs.

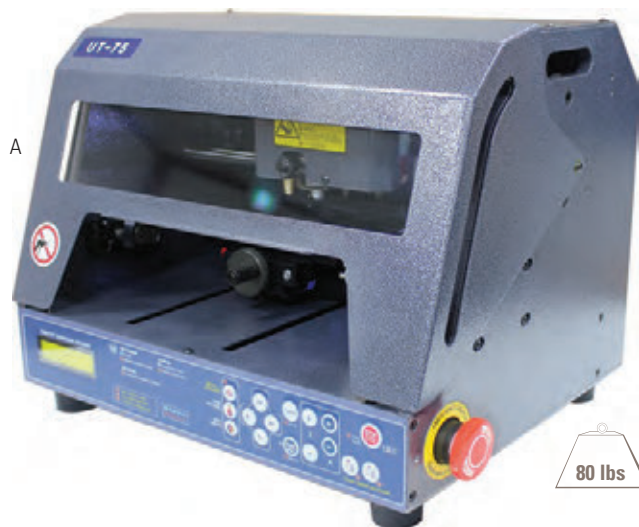

Item	Order #	Description	W x L x H	1+
A	26-3924	Dual Computerized Engraver	15 1/4" x 13 1/4" x 12 1/4"	\$7,995.00

BEST BUILT DUAL FUNCTION ENGRAVER PRO

The Best Built engraver features an intuitive Windows based software system that provides the user with options not possible on a manual engraver. This combination unit will engrave on flat and round surfaces as well as inside and outside of rings. Never before has so much engraving potential been put into one machine for such a low price. All you need to start engraving is a Windows based PC with a USB connection. The system includes software that is easy to install and operate. You are ready to start engraving in no time at all. Features:

- Flat, curved, inside ring and outside ring engraving
- Easily replaceable diamond tip
- Includes all necessary vises, clamps and jigs for holding work
- Flat engraving area is 4" x 4 1/2"
- Use any Fonts available from your personal computer
- Additional Fonts available through web downloads for free
- Import JPEG and BMP images from any online source
- Laser centering for perfect engraving
- Variable depth feature allows for engraving on uneven surfaces like ID bracelets
- 15" W x 11 3/4" L x 10" H
- Runs smooth and quiet
- 65 lbs.



Item	Order #	Description	W x L x H	1+
B	26-3919	Dual Engraver Pro	15" x 11 3/4" x 10"	\$5,495.00

REPLACEMENT TIPS FOR BEST BUILT ENGRAVERS

Order #	Description	1+
26-3923	90° Diamond Tip	\$35.00
26-3923	150° Diamond Tip	\$35.00
26-3923	120° Diamond Tip	\$35.00



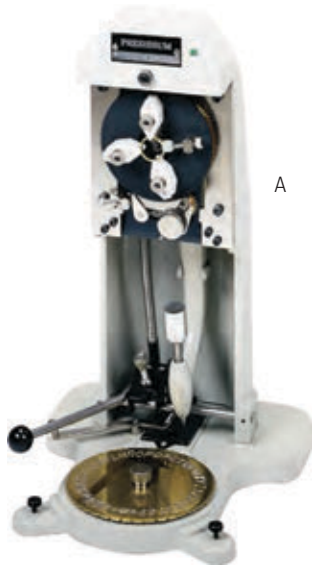

A

PRESIDIUM® INSIDE-RING ENGRAVER

The Presidium® Inside-Ring Engraver is manufactured to the highest standards. The machine is compact, user friendly and comes with a diamond engraving tip, a circular dial template, complete set of instructions, dust cover and five brass sample rings. Features include easy template installation, wide ring holding capacity, adjustable letter spacing, and the template produces letters with heights of 9mm and 4mm.

Item	Order #	Description	1+
A	26-3850	Inside-Ring Engraver	\$525.00

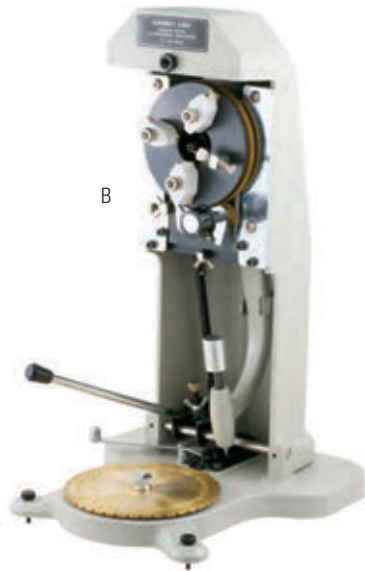

B

INSIDE RING ENGRAVER

This engraving machine is manufactured to the highest standard. It is compact and user-friendly. Features easy type installation, one single dial produces letters with heights of 1mm and 2mm, wide ring-holding capacity of ring sizes from 19mm to 30mm, adjustable letter spacing. Includes a type dial, diamond tip, and five brass sample rings. Block font dial.

Item	Order #	Description	W x L x H	1+
B	26-3780	Grobet Ring Engraver	9" x 7" x 19½"	\$525.00
	26-3781	Diamond Stylus Tip		\$46.00

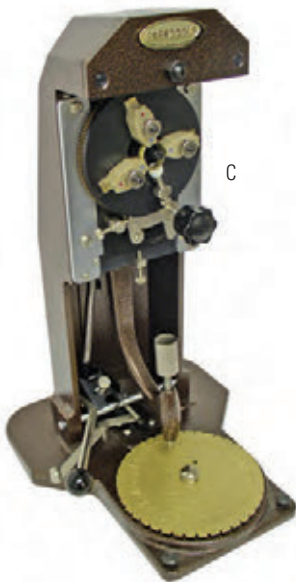

C

PEPE INSIDE RING ENGRAVER

Used for engraving on the inside of rings, this engraver will accommodate a large variety of widths and shapes including stone set rings.

- Automatic letter centering
- Uniformed character spacing
- Jaws rotate a full 360°
- Includes double sided font disc and diamond stylus and three practice rings
- Block Font Dial

Item	Order #	Description	1+
C	26-3750	Pepe Ring Engraver	\$579.00

ENGRAVING DIALS

All engraving dials measure 5" diameter with 1/2" center hole.

Item	Order #	Description	1+
A	26-3854	Continuous Modern Script Upper/Lower Case	\$98.00
B	26-3855	Modern Block Font Upper/Lower Case	\$100.00
C	26-3856	Modern Block Font Large/Small Upper Case	\$100.00
D	26-3857	Single Line Block Font	\$100.00
E	26-3858	Fancy Contentious Script Font Upper/Lower Case	\$100.00
F	26-3859	Danish Font Large/Small Upper Case	\$100.00

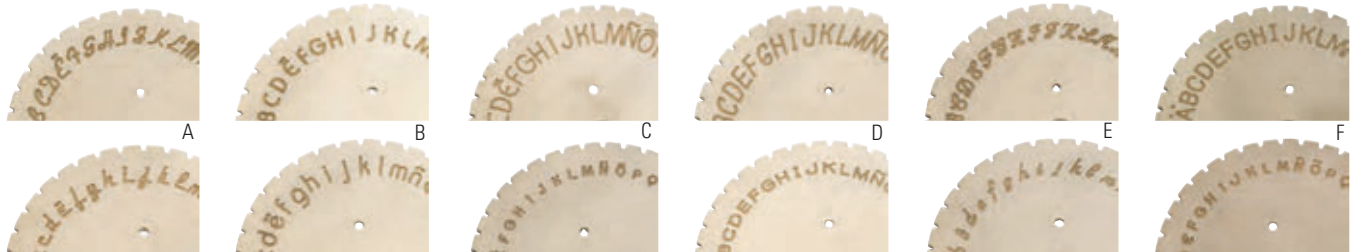

FLAT ENGRAVING MACHINE

- Includes type
- Adjustable type slide accommodates both small (1 1/4") and large (2 3/4") type
- 15 different pantograph ratios from 2 1/2:1 to 6:1
- Height adjustment for objects up to 2 1/2"
- "Quick Slide" female vise accommodates jewelry, discs up to 4" diameter, or 3 1/2" wide rectangular objects
- Diamond stylus vise rotates 360°

Item	Order #	W x H x D	1+
G	26-3770	14" x 11" x 14 1/2"	\$600.00

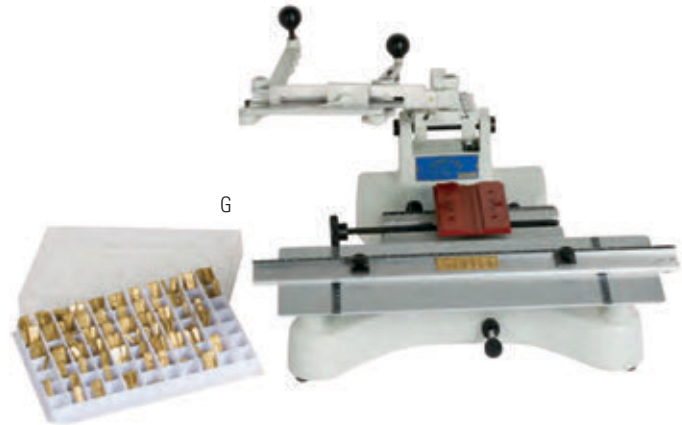

PEPE FLAT ENGRAVING MACHINE

Double tray font holding table helps save time by setting up two lines of text to be engraved. Features:

- Premium diamond stylus
- Quick slide female vise will hold plates up to 4" circular or rectangular
- 15 different pantograph ratios from 2 1/2:1 to 6:1
- Vise rotates a full 360° with stops at every 45° increment
- Set of 4 brass male pins to fit into female vise assembly
- Adjustable combination type slide accommodates both large 2 3/4" and small 1 1/4" font blanks
- Height adjustment up to 4 1/2"
- Single line block font included

Item	Order #	Description	W x L x H	1+
H	26-3760	Pepe Flat Engraving	14" x 14 1/2" x 11"	\$722.00



FONT SETS

This font set for double font table engraving machine includes 140 pieces (box included).

Item	Order #	Description	1+
J	26-3762	Single Line Block Font Set	\$215.00





A



B

Standard systems require oil-free compressed air to operate a standard handpiece. Get the GraverMach AT for integrated Airtact control featuring both hand and foot operation.

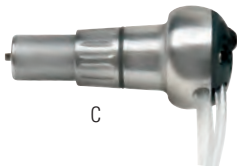

C

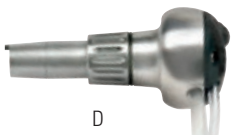

D



E

Airtact handpieces require a GraverMach AT System or a combination of any other GRS engraving system with an Airtact control system.

ENGRAVING SYSTEMS

A. GraverMach AT – GraverMach AT is wonderfully familiar to anyone who uses its predecessors, including the GraverMate, GraverMax™ SC, or GraverMach. But the expanded capability of precise, selectable hand control puts this power tool in a class by itself. The hand control technology is based on the GRS® Airtact. This advanced, patent-pending air logic system provides hand control power without adding moving parts to the handpiece itself. The result is a rugged and intuitive way to control handpiece power by hand. When foot control is preferred, it is only two seconds away. This one simple selector knob instantly gives you greater control, choice, and refinement in your work. The ability to instantly change from hand to foot control whenever you want means new creative freedom and reduced stress.

B. GraverMax™ G8 – GraverMax™ G8 is based on the original GraverMach. This engraving system gives each handpiece excellent range of power with perfect control throughout an expanded range of impact speeds. The GraverMax™ G8 features 400 to 8,000 strokes per minute, a throttle bias adjustment valve for tailoring throttle response to your work, and a dual-stage precision air regulator. Advanced ergonomics include front air pressure adjustment, Quick Change air couplings, rear mount throttle connection, and an advanced valve pulse unit that operates with virtually no noise or vibration. The GraverMax™ G8 has connections for two impact handpieces plus an auxiliary air connection for the air tools, including the GRS® Ultra 850 rotary handpiece. Handpieces sold separately.

Item	Order #	Description	W x L x H	1+
A	26-4009	GraverMach AT	6" x 13" x 8¼"	\$1,839.00
B	26-4011	GraverMax™ G8	5¼" x 12" x 8¼"	\$1,295.00

GRS® AIRTACT HANDPIECE

C. #901 – The comfortable compact shape has an adjustable side hose connection. 901 fits most engraving and stone setting needs including microscopic engraving, deep relief work, and bead raising/hammer setting. Made from fully heat-treated stainless steel, the set includes six QC holders. 2.6" (66mm) long, weighs 2.4 oz. (68g). Package includes: #901 QC handpiece, QC hand handle, 9 QC tool holders, six steel points, one GlenSteel graver, and QC holders.

D. Monarch – "Monarch" is the finest impact handpiece for confident execution of ultra-fine engraving including bulino and banknote styles. Monarch features heat-treated stainless steel construction, an elegant graverstyle handle, and adjustable side hose connection. Includes six QC holders. 2.4" (61mm) long, and weighs 7.4 oz.

E. Magnum – No other impact handpiece can equal the Magnum's range of power, from amazingly heavy to very fine. Its compact size is misleading as the Magnum exceeds the power of previous models that are twice the length. It also has fine control with shading capability significantly better than any handpiece with this much top end power.

Item	Order #	Description	1+
C	26-4036	#901 Airtact Stainless Steel	\$379.00
D	26-4038	Monarch Airtact Stainless Steel	\$359.00
E	34-2224	Magnum Airtact Stainless Steel	\$399.00

GRS® MAGNUM HANDPIECE

No other impact handpiece can equal the Magnum's range of power, from amazingly heavy to very fine. Its compact size is misleading as the Magnum exceeds the power of previous models that are twice the length. It also has fine control with shading capability significantly better than any handpiece with this much top end power.

Item	Order #	Description	1+
F	34-2224	GRS® Magnum Handpiece	\$339.00



F



QUICK-CHANGE 901 HANDPIECE SET

The comfortable compact shape has an adjustable side hose connection. 901 fits most engraving and stone setting needs including microscopic engraving, deep relief work, and bead raising/hammer setting. Made from fully heat-treated stainless steel, the set includes six QC holders. 2.6" (66mm) long, weighs 2.4 oz. (68g). Package includes: #901 QC handpiece, QC hand handle, 9 QC tool holders, six steel points, one GlenSteel graver, and QC holders.



Item	Order #	Description	1+
A	26-4037	#910 Handpiece Kit	\$349.00
B	26-4036	#901 Airtact Stainless Steel	\$379.00

QUICK-CHANGE MONARCH

"Monarch" is the finest impact handpiece for confident execution of ultra-fine engraving including bulino and banknote styles. Monarch features heat-treated stainless steel construction, an elegant graverstyle handle, and adjustable side hose connection. Includes six QC holders. 2.4" (61mm) long, and weighs 7.4 oz.



Item	Order #	Description	1+
C	26-4038	#921 Quick-Change Monarch	\$299.00

QC 915 GRAVERMEISTER HANDPIECE

The 915 fits most engraving and stone setting needs including microscopic engraving, deep relief work and bead raising/hammer setting. Made from fully heat-treated stainless steel, the set includes six QC holders. 2.6" (66mm) long. Weighs 8 oz.



Item	Order #	Description	1+
D	26-4026	#915 Quick-Change Handpiece	\$299.00

GRS® QUICK-CHANGE GRAVER ACCESSORIES

Handle with Holders: Gravers and/or tools mount into these interchangeable "QC" holders, which in turn fit all GRS® "QC" handpieces and GRS® "QC" sharpening fixture. This allows tools to be changed in three seconds without a wrench. Holders accept square tools up to 2.5mm, round tools to 3.3mm. Comes with three QC tool holders.



Item	Order #	Description	Per Unit	1+
	34-2233	Extra-Long	Pack of 3	\$25.25
E	34-2234	Extra-Long	Pack of 10	\$82.60



GRAVERSMITH PNEUMATIC POWER TOOL FOR STONE SETTING AND ENGRAVING

This new power tool offers basic work capability and pneumatic impact power for stone setting and engraving at less cost than the fully-featured machines. Like all GRS® power tools, the GraverSmith reduces worker fatigue, increases production, and improves quality. A choice of handpieces allow the GraverSmith to fit a wide range of applications and user preferences. Includes: - Variable impact rate-400 to 8,000 per minute - Heavy duty foot control - Built-in air regulator with integral pressure gauge - One handpiece outlet (handpiece sold separately) - Remote filter - Carry handle and built-in tool storage

Order #	Description	W x L x H	1+
26-4013	Graversmith	5¾" x 10" x 5¾"	\$869.00



GRS® SYSTEM 3 AIR HANDPIECE

The GRS® System 3 is an affordable air impact tool that can engrave metal, set stones, hammer, texture, and carve wood and other materials. The System 3 handpiece is a piston and port design, which self-oscillates using normal compressed air. It is comfortable, lightweight, and delivers good impact power. It requires compressed air 1.2 cfm at 50PSI minimum (35 liters per minute at 3.3 bar requiring). Includes: handpiece, foot control, air filter-regulator, three quick-change tool holders, six steel points, and instructions.

Order #	Description	1+
26-4050	System 3 Kit	\$575.00

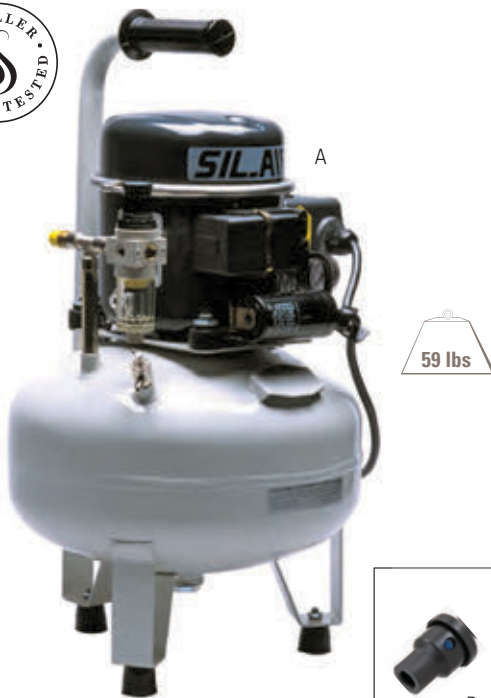

SILENTAIRE AIR COMPRESSOR

The Silentaire air compressor is virtually noiseless and is totally automatic. Unit includes a tank, line pressure gauge, line pressure regulator, moisture trap/filter/gauge, safety valve, air intake filter, and a carrying handle. The SIL-AIR models feature a heavy duty ½hp pump for reliability and durability.

Item	Order #	Description	1+
A	14-5000	4 gallon Compressor (½ hp) (40 decibel)	\$1,065.90
	14-4999	6 gallon Compressor (½ hp) (40 decibel)	\$1,149.90

MAINTENANCE PARTS

B	14-4492	Air Intake Filter	\$19.50
C	14-4493	Filter Element (Pack of 4)	\$13.60
D	14-4494	Filter Regulator WI	\$83.75
E	14-4495	Pressure Gauge ½" - Rear	\$26.00
F	14-4496	Filter Element WI	\$26.00
G	14-4497	Filter Kit N Coalescent	\$47.20
H	14-5002	24 oz Compressor Oil	\$22.80
J	14-4498	Blowgun with Coil Hose	\$41.90
K	14-5004	Air Filter / Oil Removal Kit	\$105.95
L	14-5001	Hook-Up Hose (50' x ¼")	\$42.35
M	14-5005	Quick Disconnect Kit	\$31.75





MEIJI MICROSCOPE BENCH SYSTEMS

The Meiji® Microscope is designed for working while viewing. Magnified up to 22.5X. You see clearly the finest details for both stone setting and engraving. Work hour after hour without eye strain. Finish your jobs with precision every time. No pattern or object is too small. Precision optics with a magnification range from 3.5 to 22.5, working distance of 6 inches.

A. Trinocular System 1 (8TR)

- The Meiji® 8TR Scope
- Acrobat™ stand with head rest
- Mt. kit 10X eye piece
- Ring light
- 0.5 auxiliary lens (increases working distance from 104mm (4") to 174mm (6.85"))

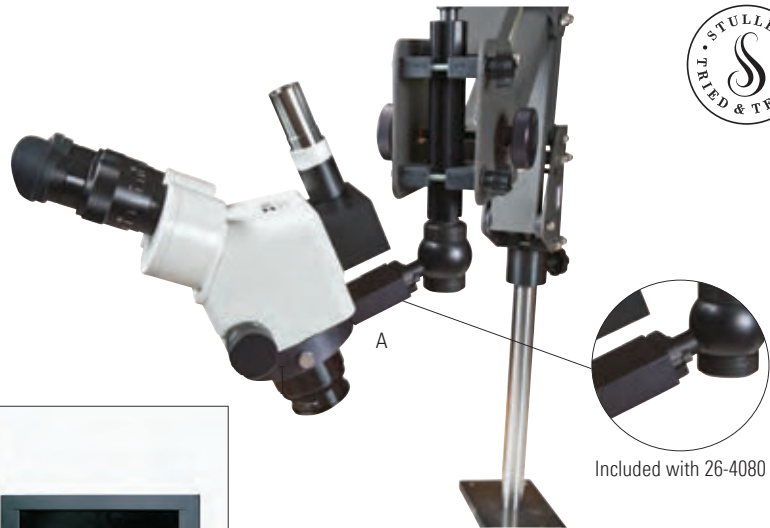

Included with 26-4080

B. Binocular System 2 (EMZ-5)

- The Meiji® EMZ-5 Scope
- Acrobat™ stand with head rest
- 10X eye piece
- Ring light
- 0.5 auxiliary lens (increases working distance from 93mm (3.66") to 150mm (5.90"))

Includes mount adaptor.



Item	Order #	Description	1+
A	26-4080	Trinocular System 1 (8TR)	\$2,495.95
B	26-4073	Binocular System 2 (EMZ-5)	\$2,095.95
C	26-4089	Mount Adaptor (included with #26-4080)	\$75.00



EYE PIECE

Super wide field eye pieces.

Order #	Description	1+
26-4082	10X (pair)	\$160.00
26-4083	20X (pair)	\$160.00



LED MICROSCOPE RING LIGHT

Natural spectrum light. Intensity can be adjusted. Super wide field eye pieces.

Order #	Description	1+
26-4196	Ring Light	\$159.95





MEJI® MICROSCOPE BODIES

Body Binocular/Trinocular Specifications:

- Zoom Ratio: 6.5:1
- Zoom Range 0.7X - 4.5X
- Zoom Control: Graduated knurled ring (EMT-2)
- Dual, Graduated, bilateral mount (EMZ-5, EMZ-8)
- Magnification: 7X - 45X (with 10X eyepieces)
- Field of View: 32mm - 5.1mm
- Working distance: 93mm (EMT-2, EMZ-5); 104mm (EMZ-8)
- Eye tube Inclination: 45°
- Interpupillary Distance Adjustment: 54mm - 75mm
- Dioptic Adjustment: Dual (+/-5)
- Extended Magnification Range: 2.1X -270X
- Extended Working Distances: 34mm - 251mm (EMT-2, EMZ-5); 38mm - 307mm (EMZ-8) with supplement tall objectives and eyepieces

Item	Order #	Description	Focal Working Distance (with lens)	1+
A	26-4079	EMZ-5 (body only)	93 mm	\$1,260.00
B	26-4098	*EMZ-8TR Auxiliary Lens 0.5mm	174 mm	\$140.00
B	26-4098	*EMZ-5 Auxiliary Lens	150 mm	\$140.00
C	26-4081	EMZ-8TR (body only)	104 mm	\$1,630.00
D	26-4086	EMT-2 Adapter (required for lens)		\$35.00

*Choose the correct lens for each scope.

COLOR TV CAMERA (FOR EMZ-8TR)

Meiji Techno Analog CCD Color Cameras provides a resolution of 768/494, a single analog video camera that offers a durable, compact light-weight microscope video and performs perfectly with trinocular microscope models and can be controlled with software via a computer(s) RS232 port. All camera setting can be saved to disc and recalled allowing repeatability of camera setup.

Item	Order #	Description	1+
E	26-4085	Camera (for 8TR)	\$1,210.00
F	26-4084	Camera Mount Adapter for 8TR (required)	\$210.00



- HDMI C-mount camera
- 1920x1080 60 fps via HDMI
- 1920x1080 30fps via USB2.0
- Still resolution 3264x1836
- Video record: 1080p 30fps on SD card or PC
- Output: HDMI, USB 2.0, SD Card
- 1/3" CMOS chip (use .3x C-mount adapter)
- Button (1) controls:
Exposure, White balance, Gamma, Gain, Sharpness, Saturation, Contrast
- Button (2) controls:
Cross line, Image Compare, Image Freeze
- OS support: Windows XP and later
- Software: ISCapture full parameter control



2 MP HD CAMERA

This HD color microscopy camera offers full 1080p video through HDMI with perfect color reproduction and extremely fast frame rate streaming direct to a monitor. You can operate the camera by directly connecting to a monitor without a PC and save images into an onboard microSD card, or use it as a standard USB 2.0 camera. The camera quickly reacts to lighting changes in any life science, clinical, or material applications. With video output via HDMI connector, the on-camera buttons allow easy access to feature settings. With 60fps at 1080p, this camera presents a perfect combination of outstanding resolution and frame rate. This allows the user to fluently manipulate the live images without any lags. With multiple output options available for this powerful camera HDMI 1080p, USB 2.0, or SD memory card can be used individually or all three simultaneously.

Order #	Description	1+
26-4059	60fps/HDMI, 30fps/USB	\$1,500.00
26-4059	0.5X "C" Mount Adapter	\$265.00

GRS® ACROBAT™ STAND

The Acrobat™ stand has outstanding flexibility, working with you and not against you. Easy position and swinging away when desired. Arm moves with adjustable friction or lock if desired. Built-in head rest.

Item	Order #	Description	1+
A	26-4094	Acrobat™ Stand (Only)	\$528.00

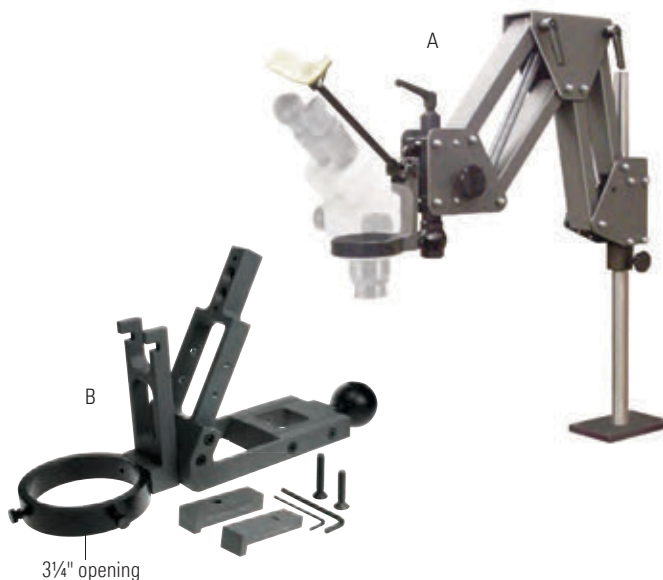

CAMERA MOUNT FOR GRS® ACROBAT STAND

This new and improved mounting system allows you to video what you see through the microscope without making any adjustments. It keeps your workplace centered at all times.

Item	Order #	Description	1+
B	26-4194	Camera Mount System	\$350.00

ADJUSTABLE SWING ARM

With a 6" reach in any direction, this exclusive design, developed here at Stuller, gives you an extra hand when setting or engraving. You can set stones under your bench microscope (26-4073), or make your GRS™ Microblock™ or mounting bracket (26-4107) even easier to use. Cam locks are built in to hold in any position.

Order #	Description	1+
26-4185	Adjustable Swing Arm (6" reach)	\$149.00



RINGENIE THE COMPLETE KIT

The RinGenie was created for designers and stone setters. The RinGenie enhances the precision of setting and engraving rings. With the RinGenie you can work with wax molds, blanks, or any style of ring. You can work at ease knowing that the RinGenie is securely holding your ring while your working. With the different angle options you get a complete veiw and range working with the ring. The Kit Includes:

- (1) Body
- (1) Drill/Mill/Layout Assembly
- (1) Scriber Assembly
- (1) 3/32 Diameter Hardened Drill bushing
- (1) Alignment Plate
- (2) Tightening Rods
- (1) Side Pointer
- (1) Drag Adjustment Screw
- (8) Plastic Collets (sizes are: 5, 6, 7, 8, 9,10,11,12)
- (16) Aluminum Collets (sizes are: 5 , 5.5, 6, 6.5, 7, 7.5, 8, 8.5, 9, 9.5, 10, 10.5, 11, 11.5, 12, 12.5)
- (1) Custom Fitted Wood Case

Order #	Description	1+
26-1700	RinGenie Kit	\$695.00
26-1700	RinGenie Adapter	\$74.95



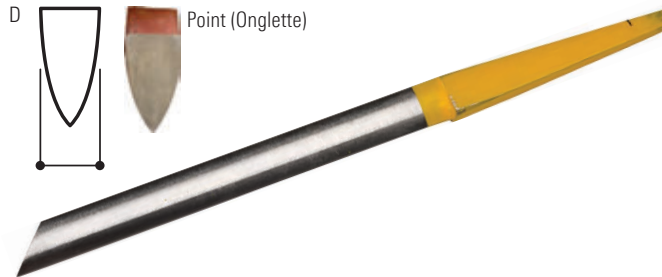
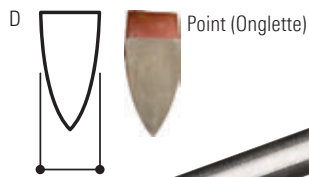
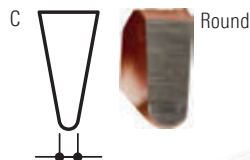
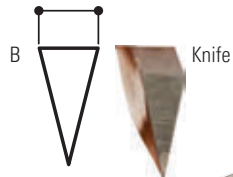
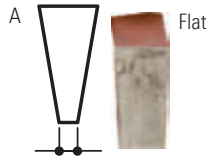

GROBET USA® SWISS HIGH-SPEED STEEL GRAVERS

Genuine, high quality, Swiss-made gravers produced from special high-speed steel for long-lasting performance. Accept no substitutes.

Item	Order #	Description	Style	Width	12+	6+	1+	
A	36-2560	Flat	#36	0.2mm	\$9.31	\$9.86	\$10.95	
	36-2561	Flat	#37	0.4mm	\$9.31	\$9.86	\$10.95	
	36-2562	Flat	#38	0.6mm	\$9.31	\$9.86	\$10.95	
	36-2563	Flat	#39	1.0mm	\$9.31	\$9.86	\$10.95	
	36-2564	Flat	#40	1.2mm	\$9.31	\$9.86	\$10.95	
	36-2565	Flat	#41	1.4mm	\$9.31	\$9.86	\$10.95	
	36-2566	Flat	#42	1.8mm	\$9.31	\$9.86	\$10.95	
	36-2567	Flat	#43	2.0mm	\$9.31	\$9.86	\$10.95	
	36-2585	Flat	#45	2.4mm	\$9.31	\$9.86	\$10.95	
	B	36-2600	Knife	#1	1.8mm	\$11.82	\$12.51	\$13.90
		36-2601	Knife	#2	2.0mm	\$11.82	\$12.51	\$13.90
36-2602		Knife	#3	2.2mm	\$11.82	\$12.51	\$13.90	
36-2603		Knife	#4	2.4mm	\$11.82	\$12.51	\$13.90	
36-2604		Knife	#5	2.6mm	\$11.82	\$12.51	\$13.90	
36-2605		Knife	#6	2.8mm	\$11.82	\$12.51	\$13.90	
C	36-2570	Round	#50	0.2mm	\$9.31	\$9.86	\$10.95	
	36-2571	Round	#51	0.4mm	\$9.31	\$9.86	\$10.95	
	36-2572	Round	#52	0.6mm	\$9.31	\$9.86	\$10.95	
	36-2573	Round	#53	1.0mm	\$9.31	\$9.86	\$10.95	
	36-2574	Round	#54	1.20mm	\$9.31	\$9.86	\$10.95	
	36-2590	Round	#55	1.80mm	\$9.31	\$9.86	\$10.95	
	D	36-2580	Point (Onglette)	#5/0	1.16mm	\$9.31	\$9.86	\$10.95
		36-2581	Point (Onglette)	#4/0	1.24mm	\$9.31	\$9.86	\$10.95
36-2582		Point (Onglette)	#3/0	1.35mm	\$9.31	\$9.86	\$10.95	
36-2550		Point (Onglette)	#2/0	1.45mm	\$9.31	\$9.86	\$10.95	
36-2551		Point (Onglette)	#0	1.58mm	\$9.31	\$9.86	\$10.95	
36-2552		Point (Onglette)	#1	1.78mm	\$9.31	\$9.86	\$10.95	
36-2553		Point (Onglette)	#2	1.94mm	\$9.31	\$9.86	\$10.95	
36-2554		Point (Onglette)	#3	2.16mm	\$9.31	\$9.86	\$10.95	
36-2555		Point (Onglette)	#4	2.54mm	\$9.31	\$9.86	\$10.95	
36-2556	Point (Onglette)	#5	2.74mm	\$9.31	\$9.86	\$10.95		
36-2557	Point (Onglette)	#6	2.94mm	\$9.31	\$9.86	\$10.95		
36-2559	Point (Onglette)	#8	3.36mm	\$9.31	\$9.86	\$10.95		

GRAVERS SHAPES WITH CUTTING ANGLES AND FACES

Flat has a rectangular cross section with a flat cutting edge used to make flat bottom cuts.

Square has an equilateral square set on its corner so the lower corner cuts the metal.

Lozenge has a rhombus shape with two acute and two obtuse angles for making "V" cuts with an acute angle.

Onglette is triangular in shape with slightly rounded sides that form a point along the bottom.

Knife has an acute triangular shape used to make deep, narrow V-shaped cuts.

Round has flat sides and a rounded bottom used to cut rounded grooves and raise beads.

Oval has an oval shape and is used to produce U-shaped cuts.

Liner has a similar shape to the flat but with shallow parallel grooves running along its bottom edge.

Dotter has a rectangular shaft with a flat top and rounded bottom used to make dots or round bottomed cuts.

Always wear eye protection when shaping and sharpening.



GROBET USA® SWISS QUICK CHANGE GRAVERS

Pre-shaped, quick-change graters are designed to fit the GRS® Quick Change Tool Holder for use with the GRS® Quick Change Handpieces. They also work with the Freedom® PowerGraver™ and the MagnaGravers™. Made from special, high-speed steel for long lasting performance. Genuine, Swiss-made with the yellow tang. Accept no substitutes.



Stone Setting Kit

Includes 11 Gravers:
36-2722, 36-2723, 36-2724, 36-2701, 36-2705,
36-2708, 36-2711, 36-2712, 36-2713, 36-2734, and 36-2736.

Engraving Kit

Includes 11 Gravers:
36-2722, 36-2724, 36-2726, 36-2701, 36-2702,
36-2705, 36-2708, 36-2712, 36-2713, 36-2734, and 36-2736.

Item	Order #	Description	Style	Width	12+	6+	1+
	36-2741	Stone Setting Kit			\$93.50	\$99.00	\$110.00
	36-2740	Engraving Kit			\$93.50	\$99.00	\$110.00
A	36-2700	Flat Edge	#36	0.2mm	\$9.27	\$9.81	\$10.90
	36-2701	Flat Edge	#37	0.4mm	\$9.27	\$9.81	\$10.90
	36-2702	Flat Edge	#38	0.6mm	\$9.27	\$9.81	\$10.90
	36-2703	Flat Edge		0.8mm	\$9.27	\$9.81	\$10.90
	36-2704	Flat Edge	#39	1.0mm	\$9.27	\$9.81	\$10.90
	36-2705	Flat Edge	#40	1.2mm	\$9.27	\$9.81	\$10.90
	36-2706	Flat Edge	#41	1.4mm	\$9.27	\$9.81	\$10.90
	36-2707	Flat Edge		1.6mm	\$9.27	\$9.81	\$10.90
	36-2708	Flat Edge	#42	1.8mm	\$9.27	\$9.81	\$10.90
	36-2709	Flat Edge	#43	2.0mm	\$9.27	\$9.81 <td \$10.90	
	36-2710	Flat Edge	#45	2.4mm	\$9.27	\$9.81	\$10.90
B	36-2732	Knife		1.8mm	\$9.27	\$9.81	\$10.90
	36-2733	Knife		2.0mm	\$9.27	\$9.81	\$10.90
	36-2734	Knife	#1	2.2mm	\$9.27	\$9.81	\$10.90
	36-2736	Knife	#2	2.6mm	\$9.27	\$9.81	\$10.90
	36-2737	Knife	#3	2.8mm	\$9.27	\$9.81	\$10.90
C	36-2711	Round	#50	0.2mm	\$9.27	\$9.81	\$10.90
	36-2712	Round	#51	0.4mm	\$9.27	\$9.81	\$10.90
	36-2713	Round	#52	0.6mm	\$9.27	\$9.81	\$10.90
	36-2714	Round		0.8mm	\$9.27	\$9.81	\$10.90
	36-2715	Round	#53	1.0mm	\$9.27	\$9.81	\$10.90
D	36-2719	Point	#5/0	1.16mm	\$9.27	\$9.81	\$10.90
	36-2720	Point	#4/0	0.20mm	\$9.27	\$9.81	\$10.90
	36-2721	Point	#3/0	1.35mm	\$9.27	\$9.81	\$10.90
	36-2722	Point	#2/0	1.45mm	\$9.27	\$9.81	\$10.90
	36-2723	Point	#0	1.58mm	\$9.27	\$9.81	\$10.90
	36-2724	Point	#1	1.78mm	\$9.27	\$9.81	\$10.90
	36-2725	Point	#2	1.94mm	\$9.27	\$9.81	\$10.90
	36-2726	Point	#3	2.16mm	\$9.27	\$9.81	\$10.90
	36-2727	Point	#4	2.54mm	\$9.27	\$9.81	\$10.90

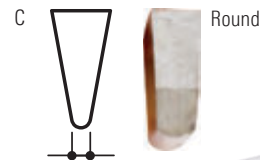
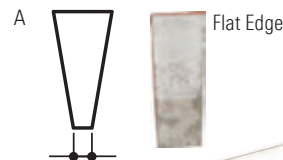

MULLER® HIGH-SPEED GRAVERS

Quality E.C. Muller® gravers hold an edge up to five times longer than carbon-steel gravers. Generally preferred for use on gold, platinum, silver, and steel. These gravers can be modified to be used with all power-assisted engraving systems and handpieces, including GRS® and Foredom® systems.



Item	Order #	Description	Style	12+	6+	1+
A	36-3523	Flat	#36	\$6.16	\$6.53	\$7.25
	36-3524	Flat	#37	\$6.16	\$6.53	\$7.25
	36-3525	Flat	#38	\$6.16	\$6.53	\$7.25
	36-3526	Flat	#39	\$6.16	\$6.53	\$7.25
	36-3527	Flat	#40	\$6.16	\$6.53	\$7.25
	36-3528	Flat	#41	\$6.16	\$6.53	\$7.25
	36-3529	Flat	#42	\$6.16	\$6.53	\$7.25
	36-3530	Flat	#43	\$6.16	\$6.53	\$7.25
	36-3531	Flat	#44	\$6.16	\$6.53	\$7.25
	36-3532	Flat	#45	\$6.16	\$6.53	\$7.25
B	36-3535	Knife	#0	\$6.16	\$6.53	\$7.25
	36-3536	Knife	#1	\$6.16	\$6.53	\$7.25
	36-3537	Knife	#2	\$6.16	\$6.53	\$7.25
	36-3538	Knife	#3	\$6.16	\$6.53	\$7.25
C	36-3511	Round	#50	\$6.16	\$6.53	\$7.25
	36-3512	Round	#51	\$6.16	\$6.53	\$7.25
	36-3513	Round	#52	\$6.16	\$6.53	\$7.25
	36-3514	Round	#53	\$6.16	\$6.53	\$7.25
	36-3515	Round	#54	\$6.16	\$6.53	\$7.25
	36-3516	Round	#55	\$6.16	\$6.53	\$7.25
	36-3517	Round	#56	\$6.16	\$6.53	\$7.25
	36-3518	Round	#57	\$6.16	\$6.53	\$7.25
	36-3519	Round	#58	\$6.16	\$6.53	\$7.25
	36-3542	Bevel	#1	\$6.16	\$6.53	\$7.25
	36-3543	Bevel	#2	\$6.16	\$6.53	\$7.25
	36-3544	Bevel	#3	\$6.16	\$6.53	\$7.25
D	36-3500	Point (Onglette)	#2/0	\$6.16	\$6.53	\$7.25
	36-3501	Point (Onglette)	#0	\$6.16	\$6.53	\$7.25
	36-3502	Point (Onglette)	#1	\$6.16	\$6.53	\$7.25
	36-3503	Point (Onglette)	#2	\$6.16	\$6.53	\$7.25
	36-3504	Point (Onglette)	#3	\$6.16	\$6.53	\$7.25
	36-3505	Point (Onglette)	#4	\$6.16	\$6.53	\$7.25
	36-3506	Point (Onglette)	#5	\$6.16	\$6.53	\$7.25

TEMPERING TEMPERATURES

Color on Polished Steel	°F	°C	Temperature	Tool Type
Light Straw	400°	204°	Very High	Gravers, Files
Straw Yellow	428°	220°	High	Scrapers, Twist Drills, Razors
Golden Yellow	469°	242°		Cold Chisels, Hammer Faces
Dark Brown-Bronze	500°	260°	Medium	Drills
Purple or Peacock	531°	277°		Chasing Punches, Springs, Dies
Full Dark Blue	550°	287°	Low	Hot Chisels, Knives
Pale Blue	610°	321°		Saw Blades, Screwdrivers
Gray-Black	630°	332°	Soft to Dead Soft	Too Soft for Steel Tools

Graver Type	Normal Cutting Angle	Number of Set-Off Faces	Angle of Set-Off Faces
Flat	30°- 45°	0	0
Square	30°- 45°	2	5°- 10°
Lozenge	30°- 45°	2	5°- 10°
Onglette	30°- 45°	0	0
Knife	30°- 45°	2	5°- 10°
Round	60°- 65°	0	0
Oval	60°- 65°	0	0
Liner	30°- 45°	0	0
Dotter	30°- 45°	0	0



MULLER® STRAIGHT LINE GRAVERS

Genuine E.C. Muller® quality grade line gravers are made of High Carbon Tool Steel and are essential for performing various engraving techniques, some of which include florentine, shading, stippling, and background work. Suitable for work on flat or convex surfaces, these gravers can be used on most metals, wood, bone, ivory, and onyx. Made in the USA.

Gravers are ordered by indicating the grade first, which is the distance between the lines. The second number indicates the number of lines required on the liner. Grade 8 is the finest line (smallest distance between the lines) and 26 is the thickest line (farthest distance between the lines).

Order #	Style	Lines	12+	6+	1+
36-6500	#8	6	\$15.94	\$16.88	\$18.75
36-6501	#8	8	\$15.94	\$16.88	\$18.75
36-6502	#8	10	\$15.94	\$16.88	\$18.75
36-6510	#12	4	\$15.94	\$16.88	\$18.75
36-6511	#12	6	\$15.94	\$16.88	\$18.75
36-6512	#12	8	\$15.94	\$16.88	\$18.75
36-6513	#12	12	\$15.94	\$16.88	\$18.75
36-6514	#12	14	\$15.94	\$16.88	\$18.75
36-6520	#14	4	\$15.94	\$16.88	\$18.75
36-6521	#14	8	\$15.94	\$16.88	\$18.75
36-6522	#14	12	\$15.94	\$16.88	\$18.75
36-6530	#16	4	\$17.72	\$18.77	\$20.85
36-6531	#16	6	\$17.72	\$18.77	\$20.85
36-6532	#16	8	\$17.72	\$18.77	\$20.85
36-6533	#16	10	\$17.72	\$18.77	\$20.85
36-6534	#16	16	\$17.72	\$18.77	\$20.85
36-6540	#18	6	\$17.72	\$18.77	\$20.85
36-6541	#18	8	\$17.72	\$18.77	\$20.85
36-6542	#18	10	\$17.72	\$18.77	\$20.85
36-6550	#20	6	\$17.72	\$18.77	\$20.85
36-6551	#20	10	\$17.72	\$18.77	\$20.85
36-6560	#24	8	\$19.85	\$21.02	\$23.35
36-6570	#26	10	\$17.72	\$18.77	\$20.85

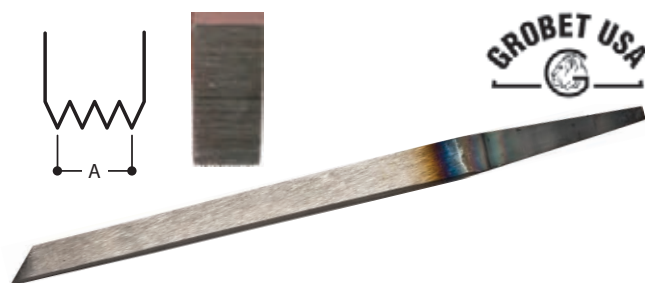

GROBET USA® SWISS CARBON LINE ENGRAVERS

All 4½" gravers. Made in Switzerland.

Order #	Style	Rows Per cm	Lines	Distance Between Lines	12+	6+	1+
					\$28.26	\$29.93	\$33.25
36-2611	#14	57	6	0.175	\$25.37	\$26.87	\$29.85
36-2612	#16	50	6	0.200	\$25.37	\$26.87	\$29.85
36-2613	#18	44	6	0.227	\$25.37	\$26.87	\$29.85
36-2614	#20	40	6	0.250	\$25.37	\$26.87	\$29.85
36-2620	#12	67	8	0.150	\$25.37	\$26.87	\$29.85
36-2621	#14	57	8	0.175	\$25.37	\$26.87	\$29.85
36-2622	#16	50	8	0.200	\$25.37	\$26.87	\$29.85
36-2623	#18	44	8	0.227	\$25.37	\$26.87	\$29.85
36-2624	#20	40	8	0.250	\$25.37	\$26.87	\$29.85
36-2630	#14	57	10	0.175	\$25.37	\$26.87	\$29.85
36-2631	#16	50	10	0.200	\$28.26	\$29.93	\$33.25
36-2635	#14	67	14	0.149	\$28.26	\$29.93	\$33.25
36-2636	#16	57	14	0.175	\$25.37	\$26.87	\$29.85



E.C. MULLER® BENT LINE GRAVERS

These High Carbon Tool Steel gravers are designed for concave surfaces with 6 as the finest and 16 being the thickest grade.

Order #	Style	Lines	12+	6+	1+
36-1200	#6	4	\$16.79	\$17.77	\$19.75
36-1201	#6	6	\$16.79	\$17.77	\$19.75
36-1202	#8	4	\$16.79	\$17.77	\$19.75
36-1203	#8	6	\$16.79	\$17.77	\$19.75
36-1204	#12	6	\$16.79	\$17.77	\$19.75
36-1205	#12	8	\$16.79	\$17.77	\$19.75
36-1206	#16	8	\$16.79	\$17.77	\$19.75
36-1207	#16	10	\$16.79	\$17.77	\$19.75



A Tapered Flat



B Tapered Round



C Flat Parellel



D Onglette

C-MAX GRAVERS

A-C. Strong demand has led to the development of additional C-Max gravers. With these three new styles, users have even more options. These gravers feature a 1/8" round shank and are made with the same GRS® C-Max carbide as the new C-Max Onglettes.

D. Introducing the new C-Max Onglette for jewelry work, stone setting, and general engraving. The carbide material for C-Max gravers provides a superior edge to traditional tool metals. Try one today and see the difference for yourself.

Item	Order #	Description	W (mm) × L (in.)	Style	12+	6+	1+
A	36-2645	Tapered Flat	0.2mm × 1 1/8"	#36	\$16.96	\$17.95	\$19.95
	36-2645	Tapered Flat	0.4mm × 1 1/8"	#37	\$15.26	\$16.16	\$17.95
	36-2645	Tapered Flat	0.6mm × 1 1/8"	#38	\$15.26	\$16.16	\$17.95
	36-2645	Tapered Flat	0.8mm × 1 1/8"	#39	\$15.26	\$16.16	\$17.95
	36-2645	Tapered Flat	1.0mm × 1 1/8"	#40	\$13.56	\$14.36	\$15.95
	36-2645	Tapered Flat	1.2mm × 1 1/8"	#41	\$13.56	\$14.36	\$15.95
	36-2645	Tapered Flat	1.4mm × 1 1/8"	#42	\$13.56	\$14.36	\$15.95
	36-2645	Tapered Flat	1.8mm × 1 1/8"	#44	\$13.56	\$14.36	\$15.95
B	36-2646	Tapered Round	0.4mm × 1 1/8"	#51	\$15.26	\$16.16	\$17.95
	36-2646	Tapered Round	0.6mm × 1 1/8"	#52	\$15.26	\$16.16	\$17.95
	36-2646	Tapered Round	0.8mm × 1 1/8"	#53	\$15.26	\$16.16	\$17.95
C	36-2647	Flat Parellel	0.6mm × 1 1/8"	#38	\$15.26	\$16.16	\$17.95
	36-2647	Flat Parellel	0.8mm × 1 1/8"	#39	\$15.26	\$16.16	\$17.95
	36-2647	Flat Parellel	1.0mm × 1 1/8"	#40	\$13.56	\$14.36	\$15.95
	36-2647	Flat Parellel	1.2mm × 1 1/8"	#41	\$13.56	\$14.36	\$15.95
	36-2647	Flat Parellel	1.4mm × 1 1/8"	#42	\$13.56	\$14.36	\$15.95
	36-2647	Flat Parellel	1.8mm × 1 1/8"	#44	\$13.56	\$14.36	\$15.95
D	36-2650	Onglette	1 1/8" length	#0	\$15.26	\$16.16	\$17.95
	36-2650	Onglette	1 1/8" length	#2	\$13.56	\$14.36	\$15.95



E



F

EASYGRAVER V-POINT SHARPENING FIXTURE

Many new engravers are challenged with understanding and consistently producing accurate sharpening results. Professionals want to save time during the sharpening process to increase profitable moments spent at the bench. The design of the EasyGraver Sharpening Fixture is based on the standard geometries that we observed in use by hundreds of engraving artists and jewelers throughout the world over many years. Two separate models are available: 120° or 105°, both for creating V-point gravers. For hand engravers and jewelers who currently use other geometries, the time it takes to adjust to these presets is outweighed by the benefits of accuracy and efficiency.

Item	Order #	Description	12+	6+	1+
E	26-3985	EasyGraver V-Point 105°	\$100.30	\$106.20	\$118.00
F	26-3985	EasyGraver V-Point 120°	\$117.30	\$124.20	\$138.00



GLENSTEEL GRAVERS

GRS[®] now offers V-shaped gravers made from GlenSteel high-speed steel for engravers, stone setters, and jewelers. These new tools have a precision ground V-point geometry on one end with a convenient 3/32" square shank on the other. GlenSteel features outstanding toughness to resist breaking and chipping, even in slender, fine shapes. An excellent all-around choice for professionals and hobbyists when a tough graver is needed. It is also cobalt-free so you are not exposed to cobalt dust when sharpening. Also for use with Lindsay templates.

Item	Order #	Description	W (mm) × L (in.)	12+	6+	1+
A	36-2540	V-Point Graver 60°	1.98mm × 2 1/2"	\$13.60	\$14.40	\$16.00
B	36-2541	V-Point Graver 75°	1.98mm × 2 1/2"	\$13.60	\$14.40	\$16.00
C	36-2542	V-Point Graver 105°	1.98mm × 2 1/2"	\$13.60	\$14.40	\$16.00
D	36-2543	V-Point Graver 120°	1.98mm × 2 1/2"	\$13.60	\$14.40	\$16.00
E	36-2545	A1 Square Graver	2.35mm × 2 3/4"	\$12.83	\$13.39	\$13.95
F	36-2546	A2 Flat Graver	2.35mm × 2 3/4"	\$12.83	\$13.39	\$13.95
G	36-2547	A3 Blank Graver	2.35mm × 2 3/4"	\$11.86	\$12.56	\$13.95



C-MAX CARBIDE GRAVERS

A tungsten carbide graver with the right blend of hardness and toughness for hand engraving and stone setting applications. C-Max achieves a metallurgical balance like no other carbide. These don't break easily and definitely hold a fine edge.

Item	Order #	Description	W (mm) × L (in.)	12+	6+	1+
H	36-2641	V-Point Graver 75°	1.98mm × 2"	\$19.42	\$20.57	\$22.85
J	36-2642	V-Point Graver 90°	1.98mm × 2"	\$19.42	\$20.57	\$22.85
K	36-2643	V-Point Graver 105°	1.98mm × 2"	\$19.42	\$20.57	\$22.85
L	36-2644	V-Point Graver 120°	1.98mm × 2"	\$19.42	\$20.57	\$22.85
M	36-2640	Round Blank Graver	2" length	\$5.91	\$6.26	\$6.95
N	36-2648	2mm Square Blank	1.98mm × 2"	\$14.88	\$15.75	\$17.50
P	36-2649	3/32" Square Blank	1.98mm × 2"	\$14.88	\$15.75	\$17.50



GRS[®] TUNGSTEN-CARBIDE GRAVERS

These are much harder than any tool steel, but more brittle. They last up to 10 times longer between sharpenings when properly used. Sharpen with a diamond wheel.

Item	Order #	Description	W (mm) × L (in.)	12+	6+	1+
Q	36-2548	Square Carbide	2.2mm × 2"	\$9.35	\$9.90	\$11.00
R	36-2549	Blank Carbide	2.2mm × 2"	\$9.35	\$9.90	\$11.00





GRS® CARBIDE BLANK AND BURNISHER TOOLS

Precision tungsten-carbide tools for texturing and burnishing. Burnish Tool – Special tool that is used for burnishing or gypsy stone setting.

Order #	Description	W (mm) × L (in.)	12+	6+	1+
36-2609	Carbide Burnish Tool	1.98mm × 2"	\$20.40	\$21.60	\$24.00

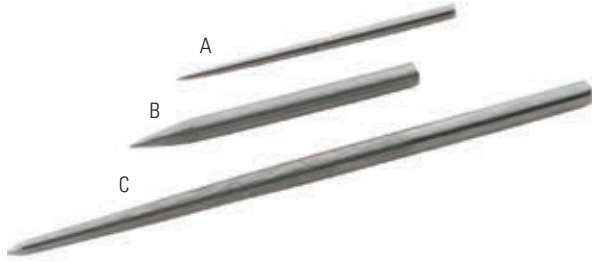

GRS® HEAT-TREATED HARDENED STEEL POINTS

Easily made into special punches, hammer tools, bead raisers, prong pushers, stipple points, and more. All points are properly hardened.



Item	Order #	W (mm) × L (in.)		12+	6+	1+
A	36-2595	1.8mm × 1½"	Sold in packs of 6	\$5.74	\$6.08	\$6.75
B	36-2596	3.1mm × 1½"	Sold in packs of 6	\$7.61	\$8.06	\$8.95
C	36-2597	3.3mm × 3"	Sold in packs of 6	\$8.93	\$9.45	\$10.50



MAGNA-GRAVER

This impact handpiece is recommended for use with the Freedom® L Motor, but can also be used with other flexible shafts. It features a one piece, 1/8" output shaft that holds shank tools with a set screw. Designed for use with Magna-Graver® gravers or custom tools fashioned from 1/8" tool steel rod. Gravers sold separately. Made in the USA.

Order #	Description	Length		12+	6+	1+
36-8801	Magna-Graver	5¾"				\$249.60



FACETED GEM-SETTING GRAVER SET

Used for setting diamonds and other stones. Set consists of six carbon steel gravers, six wooden handles, and a step-by-step model plate. Contains gravers point (onglette) #0 and #1; flat #38 and #40; and round #50 and #52.

Order #	Description		12+	6+	1+
53-0700	Gem-Setting Outfit Set		\$56.95	\$60.30	\$67.00



THERMO-LOC HANDLES

These handles let you install gravers and similar hand tools without the frustration of drilling. Inside each handle is a core made of Thermo-Loc, a special heat-softenable material. Simply warm the handle or heat the tool tang and insert the tool. At normal temperatures, Thermo-Loc™ becomes solid to hold the tool securely with a perfect fit. Includes four handles, extra Thermo-Loc, and instructions. The Thermo-Loc™ core softens between 160°-180°F (70°-80°C).

Order #	Description		12+	6+	1+
26-4140	Thermo-Loc™ Handle Set		\$12.19	\$12.72	\$13.25

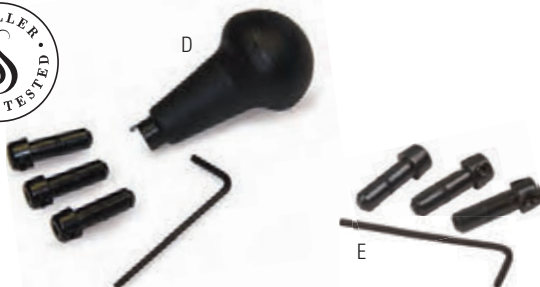

GRS® QUICK-CHANGE GRAVER ACCESSORIES

Handle with Holders: Gravers and/or tools mount into these interchangeable "QC" holders, which in turn fit all GRS® "QC" handpieces and GRS® "QC" sharpening fixture. This allows tools to be changed in three seconds without a wrench. Holders accept square tools up to 2.5mm, round tools to 3.3mm. Comes with three QC tool holders.



Item	Order #	Description		12+	6+	1+
D	26-4135	Handle with 3 Tool Holders Set		\$30.50	\$31.82	\$33.15
E	26-4137	Replacement Holder		\$16.11	\$17.06	\$18.95



ROSEWOOD GRAVER HANDLES

Used to hold gravers securely with reinforcing metal collets.

Item	Order #	Description	W x L	12+	6+	1+
A	37-8600	Half-Head	1¼" x 1½"	\$2.51	\$2.66	\$2.95
B	37-8601	Long Half-Head	1¼" x 2"	\$2.51	\$2.66	\$2.95
C	37-8602	Round	1⅝" x 1¾"	\$2.51	\$2.66	\$2.95
D	37-8603	Long Mushroom	1¼" x 2"	\$2.51	\$2.66	\$2.95



GRAVER HANDLES

Wide variety of finely finished, hardwood handles. Metal sleeve securely holds graver.

Item	Order #	Description	W x L	12+	6+	1+
E	37-8500	Gourd	2½" x 1¼"	\$1.27	\$1.35	\$1.50
F	37-8501	Half-Head	2" x 1⅝"	\$1.27	\$1.35	\$1.50
G	37-8502	Half-Head	1¾" x 1⅝"	\$1.27	\$1.35	\$1.50
H	37-8503	Half-Head	2¼" x 1¼"	\$1.27	\$1.35	\$1.50
J	37-8504	Mushroom	2" x 1¼"	\$1.27	\$1.35	\$1.50
K	37-8505	Mushroom	1¾" x 1¼"	\$1.27	\$1.35	\$1.50
L	37-8506	Mushroom	2¼" x 1¼"	\$1.27	\$1.35	\$1.50
M	37-8507	Oval	1" x 1¼"	\$1.27	\$1.35	\$1.50
N	37-8508	Pear	1⅝" x 1¾"	\$1.27	\$1.35	\$1.50
P	37-8509	Round	1⅝" x 1⅝"	\$1.27	\$1.35	\$1.50
Q	37-8510	Vase	3" x 1⅝"	\$1.27	\$1.35	\$1.50



ADJUSTABLE GRAVER HANDLE SET

Adjust your graver length to exactly what you want by sliding it in and out of the handle, then locking it in place. Lightweight aluminum. Set of three different color handles.

Order #	Description	Length	1+
26-4136	Graver Handle Set (set of 3)	2¾"	\$42.50



CROCKER-PATTERN GRAVER SHARPENER

Used to hold graver in a fixed position while sharpening on a bench stone. Graver can be set to any angle by setting index. Can also be locked in for repeated accuracy. Sharpening stone sold separately.

Item	Order #	Description	12+	6+	1+
R	36-8800	Graver Sharpener	\$40.80	\$43.20	\$48.00



GRAVER SHARPENER

Used to sharpen gravers. Place graver in either of two angled openings and then roll over a flat oilstone to sharpen. Sharpening stone not included.

Item	Order #	Description	W x L	12+	6+	1+
S	36-8840	Sharpener	1½" x 2⅝"	\$7.48	\$7.92	\$8.80





BURGESS™ VIBRO-GRAVER

Rugged, industrial-quality engraving tool makes permanent markings on almost any hard surface. Can also be used to make background effects. Features durable, tungsten-carbide engraving tip, an on/off switch, and a spark-free motor that vibrates at 7,200 strokes per minute. Adjustment dial changes length of stroke and depth of mark. Includes carbide bit. Diamond bit not included.

Order #	Description	12+	6+	1+
36-8000	Vibro-Graver 110V	\$47.60	\$50.40	\$56.00



POST ASSEMBLY FOR GRS® SHARPENING FIXTURES

For use with GRS® Sharpening Fixtures.

Order #	Description	12+	6+	1+
26-3986	Post Assembly	\$25.46	\$26.96	\$29.95



GRAVER LUBE KIT

Extends graver life and brightens cuts. Sharpen your graver less and your work will look better. Includes lube container with lid and sponge.

Order #	Description	Size	1+
10-4555	Graver Lube Oil Kit	4 oz	\$9.55



NORTON SHARPENING STONE OIL

Primarily used as sharpening oil, but can be used for general purposes.

Order #	Description	Size	12+	6+	1+
10-6015	Norton™ Sharpening Oil	4½ oz	\$8.42	\$8.78	\$9.15



MOUNTED ARKANSAS BENCH STONE

Excellent for sharpening tools such as gravers and knives due to the close-density oilstone qualities. Mounted in cedar box.

Order #	Grit	W × L × H	1+
10-5510	Fine	2" × 4" × 1/2"	\$19.35
10-5520	Extra-Fine	2" × 4" × 1/2"	\$45.90



RUBY BENCH STONES

Excellent for sharpening and flattening hard metals as well as glass, quartz, and porcelain.

Item	Order #	Description	Grit	W × L × H	1+
A	10-4203	1-Sided Boxed	Medium	1" × 4" × 3/8"	\$105.10
B	10-4204	1-Sided Boxed	Fine	1" × 4" × 3/8"	\$134.65
C	10-4210	2-Sided Loose	Medium	1" × 4" × 3/8"	\$136.70

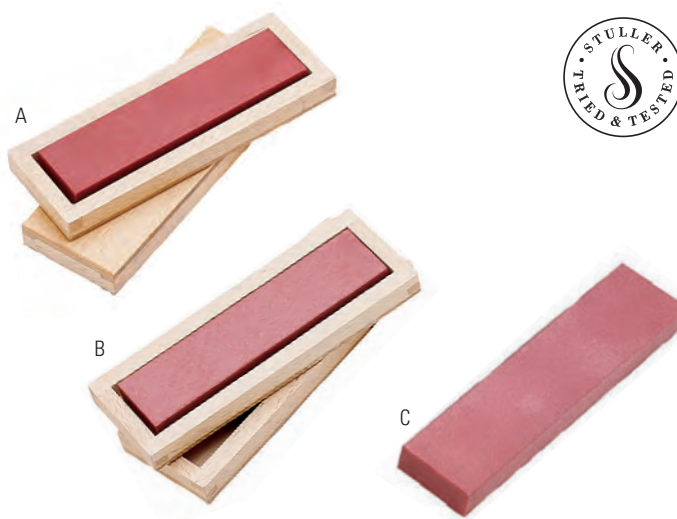

ARKERAM BENCH STONES

Made from Arkansas stone powder, solidified by fire. Slightly more abrasive than regular Arkansas stones. Shipped in a hardwood box and can be used on both sides with oil.

Order #	W × L × H	1+
10-6008	1" × 4" × 1/2"	\$37.25
10-6010	2" × 6" × 1"	\$50.95



COMBINATION INDIA BENCH STONE

One side has fine grit, and the other side is coarse. Fast-cutting, man-made stone of a tough, aluminum-oxide abrasive.

Order #	W × L × H	1+
10-4500	1 3/4" × 4" × 5/8"	\$17.30
10-4510	2" × 6" × 1"	\$26.50





GRS® STANDARD BLOCK

Double ball-bearing system for smooth rotation without looseness or wear. The unique GRS® rotational break system lets you control the rotational resistance similar to the magna block. Block is made of solid steel. Black jaws and satin chrome finish reduce glare and eye strain. GRS® standard block includes upper jaw plates, four pins, and wrench.

- Stainless steel body - Block weight 19 lbs - Jaw height 1½"
- Ball diameter 5" - Max opening 3" - Jaw width 2½"

Item	Order #	Description	1+
A	26-4131	Standard Block with Attachment Kit	\$507.55
	26-4129	Standard Block (only)	\$445.15



GRS® MAGNA BLOCK

B. Heavy-duty block for exceptional support and strength. Two ball bearings and a thrust bearing large-roller, eliminates wear and looseness for the life of the block. Jaws are hardened steel. Rotational resistance is infinitely adjustable for fine tuning the block to your work. Non-glare finish. Block includes upper jaw plates, five pins, and wrench.

- Stainless steel body - Block weight 30 lbs - Jaw height 1¾"
- Ball diameter 5¾" - Max opening 3½" - Jaw width 3"

C. GRS® 30 Piece Attachment Set includes: leather-faced ring clamps plus a variety of pins and clamps to fit upper jaws of engraving blocks

Item	Order #	Description	1+
B	26-4128	Magna Block with Attachment Set	\$700.00
C	26-4130	30 Piece Attachment Kit (only)	\$93.50



GRS® POSITIONING VISE

D. Especially made for microscope work. This unique vise has many magna block similarities and one huge difference: You can reposition its center of rotation by simply pulling a lever. By pulling the release lever, you can slide the upper half into various positions. Under a microscope, your work must stay in the field of view as you rotate the vice. The positioning vise allows you to keep your work within the microscope's field of view. Includes upper jaw plates, five pins, and wrench. Specifications: - Block weight 42 lbs - Jaw height 1.8" - Ball diameter 7.1" - Max jaw opening 3½" - Jaw width 3"

E. Engraving Block Shelf: Attaches easily to GRS® fixed mounting plate to hold your engraving block off the front of your bench. This puts your engraving block at the same working height as your bench pin.

Item	Order #	Description	1+
D	26-4157	Positioning Ball Vise	\$829.95
E	26-4156	Large Block Shelf	\$82.00



GRS® LOW PROFILE VISE

The stainless steel low profile model offers GRS® strength and quality in a shorter model. A popular use is under a microscope where 6" (150mm) of space is needed between the microscope and the work. Using other blocks, the eye level of the user can be too high. The low profile vise has the same jaw size and capacity as the Magna Block, yet is 1½" shorter. An option for this vise is a heavy-duty turntable base. Includes upper jaw plates, five pins, and wrench.

- Block weight 20¼ lbs (9.19kg) - Jaw height 1½" (46mm)
- Ball diameter 6⅞" (147mm) - Max opening 3½" (89mm) - Jaw width 3" (76mm)

Item	Order #	Description	1+
F	26-4139	GRS® Low Profile Vise	\$630.00
G	26-4162	Turntable Base with Break & Teflon Pad	\$280.00

SUPER PINS

Heavy-duty plastic and steel pins fit jaw holes in GRS® Magna Block and GRS® Standard Block.

Item	Order #	Description	Diameter	1+
A	26-4133	2 Pins	3/8"	\$5.90
B	26-4134	4 Pins	1/4"	\$8.90

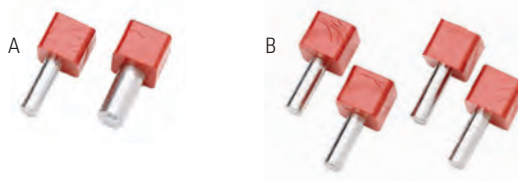
**GRS® MICROBLOCK BALL VISE**

C. For engraving stone setting and other precision work. The Microblock's stainless steel low profile body, stainless steel jaws, and compact design is especially suited for microscope work or other situations where the size of a larger vise is an obstacle.

D. GRS® 30 Piece Attachment Set includes: leather-faced ring clamps plus a variety of pins and clamps to fit upper jaws of engraving blocks

Item	Order #	Description	1+
C	26-4167	Microball	\$260.00
D	26-4130	30 Piece Attachment Kit (only)	\$93.50

**ENGRAVING BLOCK**

Recognized worldwide as the finest block. Side slack is eliminated as the turntable revolves on Victor® bearings; however, it is responsive to the slightest touch. Center screw allows the opening and closing of the deep jaws. Used to firmly hold objects for engraving, stone setting, and general work. 5" diameter block.

Item	Order #	Description	Diameter	1+
E	26-2004	Block	5"	\$467.25
F	26-2010	Set of Attachments (only)		\$124.75

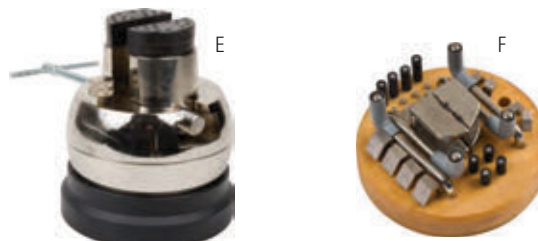
**GRS® TURNTABLE BASE**

Used with the low profile vise, this heavy turntable base lets you reposition the work's center of rotation for working under a microscope. A removable centering post lets you position the turntable in the precise center of your microscope's field of view.

Item	Order #	Description	Diameter	1+
G	26-4162	Turntable Base with Break & Teflon Pad	10"	\$280.00
H	26-4163	Mount Kit		\$20.15

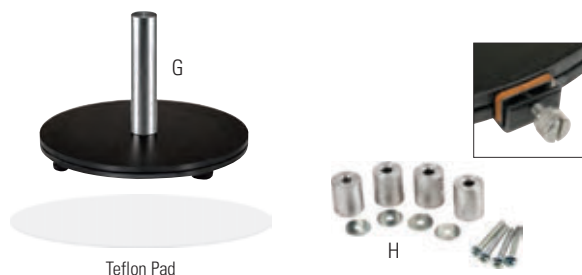
**GRS® MOUNTING PLATES**

J. **Optional Mounting Adapter:** Used to attach the fixed mounting plate to bench tops.

K. **Fixed Mounting Plate:** Used for mounting BenchMate and other GRS® products to your bench.

L. **Adjustable Height Bracket:** Includes an additional fixed mounting plate that can be lowered up to 4" in 1/2" increments.

M-N. **Engraving Block Shelf:** Attaches easily to GRS® fixed mounting plate to hold your engraving block off the front of your bench. This puts your engraving block at the same working height as your bench pin.

Item	Order #	Description	1+
J	26-4106	Mounting Adapter	\$27.55
K	26-4107	Ceramic Lap	\$199.00
L	26-4108	Height Bracket	\$52.90
M	26-4105	Small Block Shelf	\$42.35
N	26-4156	Large Block Shelf	\$82.00



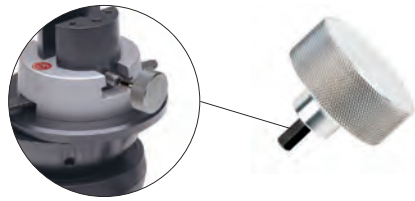

HEXAGON KEY FOR BALL VISE

Hexagon key ball vise with knurled aluminum low profile handle design so it can be left inserted in block chuck while working. Fits all GRS® vises except the Microblock. (Block not included)

Order #	Description	Outside Diameter	12+	6+	1+
58-2439	Hexagon Key	1/4"	\$14.41	\$15.26	\$16.95



RING PAD

When used with engraving blocks, it insulates the workbench surface from heat. Also serves as a rest for the engraving block.

Order #	Description	Diameter	12+	6+	1+
26-3660	Leather	5"	\$56.19	\$59.49	\$66.10



PIN PLATE

A. Single Pin: For multi-purpose and standard vise. Plate will pivot to hold unusual shapes.

B. Double Pin: For multi-purpose vise. This is a stationary plate with two mounting pins to prevent pivoting.

Item	Order #	Description	12+	6+	1+
A	26-4151	Single Pin Plate	\$23.80	\$25.20	\$28.00
B	26-4152	Double Pin Plate	\$23.80	\$25.20	\$28.00

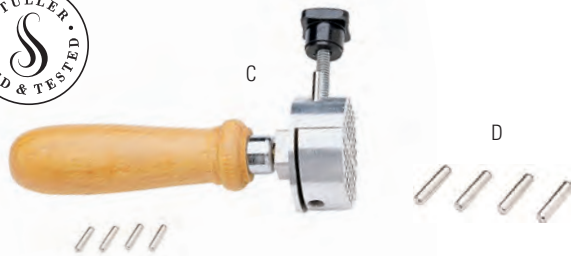

PEG CLAMP

Hand-held tool that holds small, odd-shaped articles for engraving. Jaws are 2" round, and open and close on twin guides, which are controlled by the threaded thumbscrew. Detachable wooden handle allows head to be mounted in vise. Includes four pegs. Overall length 5 3/4".

Item	Order #	Description	Length	12+	6+	1+
C	26-5000	Peg Clamp	5 5/16"	\$17.26	\$18.27	\$20.30
D	26-5001	Set of 4 Pins		\$2.68	\$2.84	\$3.15



GRS® RING-CLAMP SET

Leather-faced attachment for GRS® blocks, holds rings solid to set stones, bright cut, engrave, and finish.

Order #	Description	12+	6+	1+
26-4147	Ring Clamp Set	\$22.48	\$23.81	\$26.45

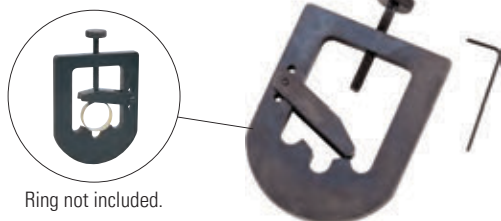

Ring not included.

GRS® INSIDE RING ENGRAVING HOLDER

This handy ring holder securely holds a ring and allows easy access to the inside of the ring for engraving. Designed to be held in the hand or in a bench or ball vise. Made of hardened steel.

Order #	Description	12+	6+	1+
26-4154	Ring Holder	\$55.25	\$58.50	\$65.00

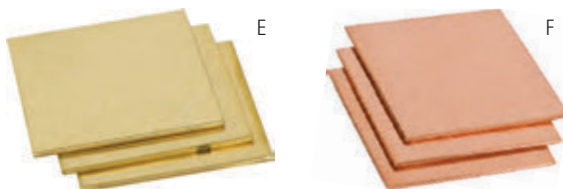

ENGRAVING PRACTICE SHEETS

Use to practice engraving and stone setting. Flat plates come in half-hard brass and copper. Sold in packs of 3.



Item	Order #	Description	W x L	12+	6+	1+
E	26-4165	Square Brass	2" x 2"	\$15.50	\$16.18	\$16.85
F	26-4166	Square Copper	2" x 2"	\$10.35	\$10.80	\$11.25

GRS® PITCH BOWL AND PITCH CUP

Both are filled with a special, meltable material that softens when heated. They allow you to hold small, fragile, irregular, or thin pieces for engraving, setting, and finishing. Both will fit any vise or engraving block.

Item	Order #	Description	W x L x H	12+	6+	1+
A	26-4113	Pitch Bowl	3¼" x 4¾" x ½"	\$62.05	\$64.75	\$67.45
B	26-4149	Pitch Cup	2" Diameter	\$23.78	\$24.82	\$25.85

**PITCH BOWL KIT**

Suitable for holding or supporting jewelry for engraving. The bowl is made of cast iron and rests on a rubber pad. The bowl can be tipped to a comfortable working angle. Includes: pitch, bowl, and rubber pad.

Item	Order #	Description	Size	12+	6+	1+
C	26-4205	Pitch Bowl Set	6¼" Diameter			\$39.75
	26-4215	Pitch	8 oz	\$33.30	\$34.75	\$36.20
	26-4216	Pitch	32 oz	\$48.76	\$50.88	\$53.00

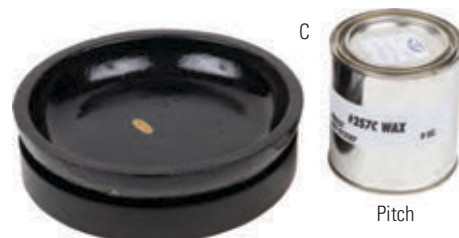
**BRASS SHEETS**

Used to practice engraving. Sold in 12 sheet packs.



Order #	Description	W x L	12+	6+	1+
36-1556	Brass Sheets	¾" x 2¼"	\$24.38	\$25.44	\$26.50

**COPPER RINGS**

Use to practice engraving.

Order #	Description	12+	6+	1+
26-5400	Copper Rings	\$1.75	\$1.82	\$1.90

**SYNTHETIC BEESWAX**

When rubbed on a surface, it leaves a film on which a design can be marked.

Item	Order #	Description	Size	12+	6+	1+
D	26-1000	Beeswax	1 oz tube	\$3.50	\$3.65	\$3.80
E	26-1002	Cake	1 lb cake	\$9.35	\$9.90	\$11.00

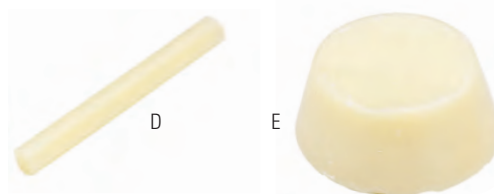
**CHINESE WHITE**

Apply onto a surface when melted, allows an impression to be left by a pencil mark.

Item	Order #	Description	Size	12+	6+	1+
F	26-1600	Small Cake	0.19 oz	\$12.88	\$13.44	\$14.00

**ORANGE FLAKE SHELLAC**

When heated, it is used to hold objects for chasing, engraving, or setting.

Item	Order #	Description	Size	12+	6+	1+
G	12-2270	Flake Shellac	16 oz	\$12.33	\$12.86	\$13.40

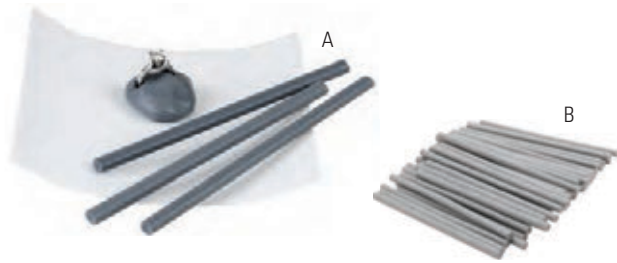

THERMO-LOC® STARTER

Kit includes 6" square PTFE (Teflon pad) and 1 lb. Thermo-Loc® sticks. Thermo-Loc® is a special reusable polymer material that is rigid at room temperature yet becomes softly pliable when heated/ warmed. Always place on Thermo-Loc® (Teflon) pad when warming in microwave oven. Ring not included.

Item	Order #	Description	12+	6+	1+
A	26-4168	Starter Kit	\$36.34	\$37.92	\$39.50
B	26-4169	1 lb of Sticks	\$29.44	\$30.72	\$32.00



JETT SETT™ THERMOPLASTIC COMPOUND

C. Jett Sett™ is a thermoplastic compound used for stone setting, riveting, engraving, and holding parts. Use it to make rigid molds, drying forms, texture plates, and custom clay stamping tools. Make custom handles and grips for your favorite tools. Jett Sett™ has ceramic component that makes it so strong it can be used to make dies for hydraulic presses. Jett Sett™ is made workable by soaking pellets in hot water, then gathering it into a ball of pliable material. Jett Sett™ becomes rock hard when it cools and cannot be chipped, cracked, or broken even when applying force with hammers or hydraulics.



JETT SETT™ PLASTIFORM

D. Plastiform is a low temperature, hand-formable, non-toxic thermoplastic with many uses for the jewelry industry. It is a unique material that is resilient plastic at room temperature but melts into a clear gel at only 140°. This process can be repeated indefinitely, making Plastiform very economical to use. Plastiform was originally developed for the jewelry industry as a shellac substitute.

Item	Order #	Description	Size	12+	6+	1+
C	12-2280	Thermoplastic Compound	1 lb	\$36.62	\$38.21	\$39.80
D	12-2288	Plastiform Compound	1 lb	\$22.04	\$24.80	\$27.55



SHELLAC STICKS

Opaque stick used for setting jewels and stones and for temporarily holding objects. Heat to apply.

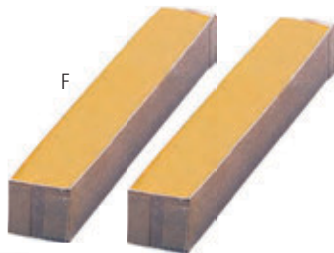

Item	Order #	Description	Length	12+	6+	1+
E	12-2300	Shellac Stick	7"	\$10.99	\$11.47	\$11.95



CHASER'S CEMENT

Use to attach objects to work holders. In bar form, but melts easily. Can be cleaned with alcohol. Two ½ lb. bars per box.



Item	Order #	Description	Size	12+	6+	1+
F	12-2030	Chaser's Cement	2- ½ lb bars	\$36.11	\$37.68	\$39.25

DIAMOND SETTERS CEMENT

Securely holds diamonds or other precious stones for polishing operations when melted and applied to a wooden dowel.

Item	Order #	Description	W x L x Depth	12+	6+	1+
G	12-2080	Setters Cement	3" x 3" x ¼"	\$24.89	\$25.97	\$27.05



GRS® SHELLAC PAD

Inserts into the jaws of BenchMate™ for setting and engraving.

Item	Order #	Description	12+	6+	1+
H	26-4112	Shellac Pad	\$4.74	\$4.94	\$5.15

DOUBLE-ENDED STEEL TRACER

Twisted center allows firm grip. Ends are finely honed.
Overall length is 6½".

Item	Order #	Description	Length	12+	6+	1+
A	52-9660	Tracer	6½"	\$8.07	\$8.55	\$9.50

**DIAMOND-TIPPED SCRIBER**

Used to scribe hardest metals, glass, and stones. Hexagonal, aluminum handle prevents rolling.

Item	Order #	Description	Length	12+	6+	1+
B	52-9504	Scriber	5¼"	\$15.56	\$16.47	\$18.30

**TUNGSTEN-CARBIDE TIP SCRIBER**

Tungsten-carbide tip scriber marks stainless steel, copper, ceramics, and platinum. Screw chuck for reversing tungsten-carbide point when not in use. Tip is replaceable. Measures 6" overall.

Item	Order #	Description	12+	6+	1+
C	52-9505	Tungsten-Carbide Tip Scriber	\$5.87	\$6.21	\$6.90
	52-9506	Replacement Tips	\$2.81	\$2.97	\$3.30

**CARBIDE TIPPED SCRIBER**

Used to scribe hardest metals, glass, and stones. Hexagonal, aluminum handle prevents rolling. Slim-line design, comfortable to use.

Item	Order #	Description	Length	12+	6+	1+
D	52-9502	Scriber	5¼"	\$4.17	\$4.41	\$4.90

**TUNGSTEN-CARBIDE SCRAPERS**

Flat-sided, tungsten-carbide scrapers are ideal for flash and bur removal on precious metals. Recommended for platinum.

Item	Order #	Tip Diameter	Tip Length	Overall Length	12+	6+	1+
E	18-0520	3 mm	1¼"	6¼"	\$17.21	\$18.23	\$20.25
F	18-0521	4 mm	1¼"	6¼"	\$17.21	\$18.23	\$20.25
G	18-0522	5 mm	1¼"	6¼"	\$17.21	\$18.23	\$20.25

**WALLER SCRIBER**

Used to scribe hard metal, glass, and stone. Reversible ends for protection while carrying.

Item	Order #	Description	12+	6+	1+
H	52-9500	Scriber	\$5.61	\$5.94	\$6.60
	52-9501	Replacement Tip	\$4.42	\$4.68	\$5.20





GRS® SHARPENING SYSTEMS

Sharpen gravers and tools in seconds without heat using the GRS® Power Hone. It provides a sharper, stronger tool edge for brighter cuts, cleaner lines and scrolls, more precise beads, and finer shading. Beginners learn proper sharpening in minutes with easy-to-use sharpening fixtures made for the GRS® Power Hone. Diamond wheels and a low speed allow hardened steel, high-speed steel, and carbide tools to be sharpened. With its heavy steel housing, continuous-duty motor, and double-bearing spindle, the GRS® Power Hone is a sharpener users can depend on for years.

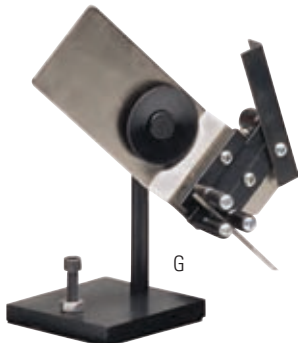
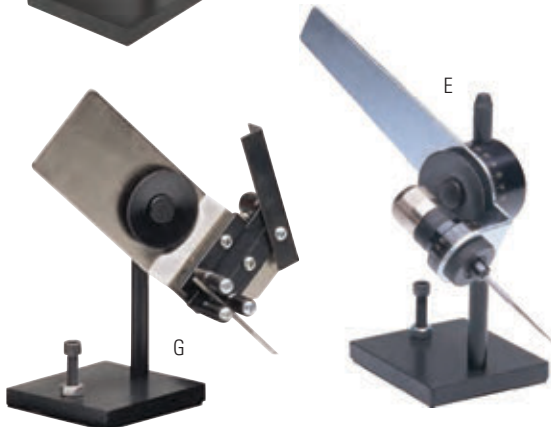
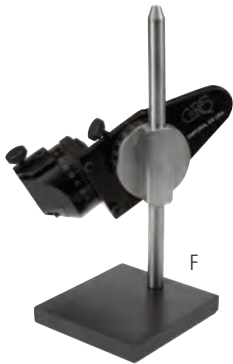

GRS® POWER HONE™ SYSTEMS

Dual Angle System Includes: a dual-angle sharpening fixture, power hone, quick wheel change adapter, 260 grit and 600 grit diamond wheels, ceramic lap, ½ micron diamond spray, and wheel storage rack.

Quick-Change System Includes: quick change sharpening fixture, power hone, quick wheel change adapter, 260 grit and 600 grit diamond wheels, ceramic lap, ½ micron diamond spray, and wheel storage rack.

Item	Order #	Description	1+
A	26-4161	Dual Angle Fixture System	\$1,089.00
B	26-3999	Quick-Change Fixture System	\$1,054.00

GRS® BASIC POWER HONE™

C. GRS® Power Hone™ uses diamond wheels to sharpen hardened steels, high speed steels, and carbides. The wheels last for years and stay flat for accuracy. Different grits are available from coarse to mirror polishing. With its heavy steel housing, continuous-duty motor, and double-bearing spindle, the GRS® Diamond Power Hone™ is a sharpener you can depend on for years. Includes 600 grit diamond wheel, quick wheel adaptor. 115V and 220V models available.

Item	Order #	Description	1+
C	26-4160	Diamond Power Hone (without fixture)	\$498.00

GRS® QUICK WHEEL CHANGE ADAPTER (FOR ORIGINAL)

D. Change Power Hone™ wheels in two seconds. This drive plate assembly replaces the standard wheel knob. To change wheels, you just lift them on and off. Quick wheel change adapter shown with Power Hone system. Sharpening wheel and Power Hone not included.

Item	Order #	Description	1+
D	26-4019	Wheel Change Adapter	\$69.00

GRS® DUAL-ANGLE SHARPENING FIXTURE

E. The dual-angle sharpening fixture holds a wider variety of tools and adjusts to more angles than the standard fixture. With two degree dials, you can set the elevation angle and the rotation angle of each tool. This fixture is accurate and beautifully made. Its degree dials are large and easy to read. All tool gripping surfaces are hardened steel for long life.

GRS® QUICK-CHANGE SHARPENING FIXTURE

F. Just insert your tool into the front of the unit and sharpen. The unit has two-degree dials, plus a unique detente system that makes sharpening fast, easy and accurate. Comes with stand.

GRS® STANDARD SHARPENING FIXTURE

G. You'll sharpen accurate tools because the degree dial lets you set the precise angle. Saves time and gives you a better edge for making the cleanest, smoothest cuts ever. Holds tools with or without handles.

Item	Order #	Description	1+
E	26-4001	Dual Angle Sharpening Fixture	\$249.00
F	26-4000	Quick-Change Sharpening Fixture	\$214.00
G	26-4002	Standard Sharpening Fixture	\$138.00



GRS® POWER HONE ACCESSORIES

Item	Order #	Description	OD	Grit	Micron	12+	6+	1+
A	26-4014	Diamond Wheel	5"	260		\$84.15	\$89.10	\$99.00
B	26-4015	Diamond Wheel	5"	600		\$76.50	\$81.00	\$90.00
C	26-4016	Diamond Wheel	5"	1200		\$76.50	\$81.00	\$90.00
D	26-4017	Ceramic Lap	6"			\$183.08	\$191.04	\$199.00
E	26-4018	Wheel Storage Rack				\$17.98	\$19.04	\$21.15
F	26-4043	Diamond Spray Grade - Coarse			3μ	\$27.83	\$29.04	\$30.25
G	26-4042	Diamond Spray Grade - Medium			1μ	\$27.83	\$29.04	\$30.25
H	26-4041	Diamond Spray Grade - Fine			1/2μ	\$27.83	\$29.04	\$30.25
J	26-4040	Diamond Spray Grade - Extra Fine			1/4μ	\$27.83	\$29.04	\$30.25



STEVE LINDSAY TEMPLATE KITS

The Lindsay graver sharpening fixture is a quick way to consistently sharpen a 3/32" square graver point accurately. Using the universal template, the sharpener will grind the patented Uniform-Parallel Point™ in a variety of configurations, as well as produce other points. A huge benefit of this sharpener is that it is repeatable as far as making a particular point that is normally fussy to produce with adjustable angle type sharpeners. Kit contains a Lindsay sharpening fixture and Uniform-Parallel Point template (Image K).

Item	Order #	Description	1+
K	26-3990	Sharpening Fixture without Stones	\$92.55
L	26-3991	Universal Template and 4 Diamond Bench Stones	\$234.00
	26-3992	4 Templates and 4 Diamond Bench Stones	\$305.80



STEVE LINDSAY TEMPLATES

These templates work with the Lindsay sharpening fixture. They allow you to create the designed point every time flawlessly. Use only with 3/32" square graver.

Item	Order #	Description	1+
M	26-3997	Universal Uniform-Parallel Point	\$23.95
N	26-3997	Roland Baptist Gold Inlay	\$23.95
P	26-3997	Dario Cortini Bulino	\$23.95
Q	26-3997	Calligraphy Uniform-Parallel Point	\$23.95
R	26-3997	70° Bulino	\$23.95
S	26-3997	Round Bottom	\$23.95
T	26-3997	Phil Coggan Bulino	\$23.95
U	26-3997	Detailing	\$23.95
V	26-3997	Flat and Knife Combo	\$23.95
W	26-3989	Sharpening Fixture	\$68.65

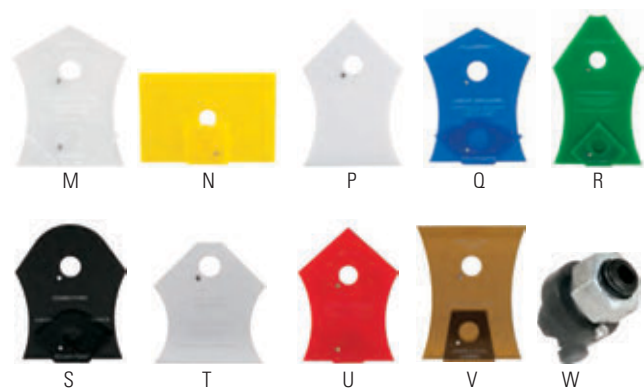

DIAMOND BENCH STONES

Item	Order #	Grit	1+
Y	26-3993	260	\$41.45
Z	26-3994	600	\$41.45
AA	26-3995	1200	\$41.45
AB	26-3996	2000	\$41.45

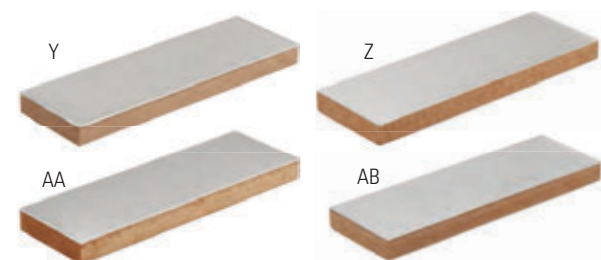



GRS® QUICK-CHANGE GRAVER HOLDER

A. Organize your work area and protect your tools by utilizing this great storage system. It comes with 12 different color-coordinating trays and collars so that you can better organize your tools. Collars slide over the tools next to the QC Tool Holder. The color coding system saves time and keeps you organized. The trays are set at an angle for easy removal, and it is easier to see the graver points. The system holds 120 QC tools in a nice compact organized fashion. Includes small plastic magnifier.

Get 12 different colored trays and color-coordinated collars to mark your tools. Each tray holds 10 tools and comes with 10 collars of each color. Includes small plastic magnifier.

Item	Order #	Description	Quantity	12+	6+	1+
A	26-4180	QC Storage System				\$53.00
	26-4181	QC Storage Trays Set	12 Piece	\$33.99	\$35.47	\$36.95



GRS® QUICK-CHANGE GRAVER ACCESSORIES

Handle with Holders: Gravers and/or tools mount into these interchangeable "QC" holders, which in turn fit all GRS® "QC" handpieces and GRS® "QC" sharpening fixture. This allows tools to be changed in three seconds without a wrench. Holders accept square tools up to 2.5mm, round tools to 3.3mm. Comes with three QC tool holders.

Item	Order #	Description	Per Unit	12+	6+	1+
B	26-4135	Handle with 3 Tool Holders Set		\$30.50	\$31.82	\$33.15
C	26-4137	Replacement Holder	3 Pack	\$16.11	\$17.06	\$18.95
	26-4138	Traditional Holder	10 Pack	\$46.79	\$49.55	\$55.05
D	34-2233	Extra-Long	3 Pack	\$21.46	\$22.73	\$25.25
	34-2234	Extra-Long	10 Pack	\$70.21	\$74.34	\$82.60
E	34-2231	3/2" Round Holder	3 Pack	\$17.43	\$18.45	\$20.50
	34-2229	3/2" Round Holder	10 Pack	\$59.88	\$63.41	\$70.45
F	34-2232	Soft-Hit QC Holder	10 Pack	\$27.16	\$28.76	\$31.95

Gravers handles found on page 238-239

PARTS OF GRAVER

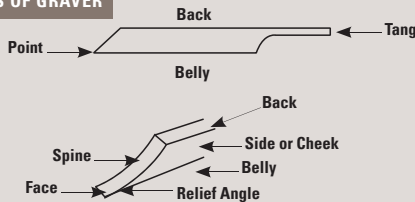

POINT SHAPES

Option 1
Best for Knife
Onglette, Lozenge

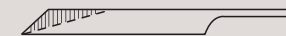

Option 2
Best for Flat,
Round

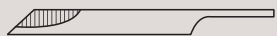

SET-OFF AND RELIEF ANGLES



CUTTING GRAVER TO LENGTH

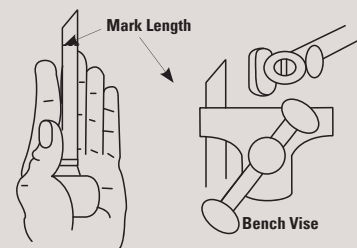

SELECTING THE RIGHT FILE FOR THE JOB

In choosing the correct file for any application, three factors need to be considered: shape, size and cut. Shape and size are more a choice of application, but generally the shape of the file should match the contour of the object being filed. In selecting the cut, it is important to know that files are made in a range of tooth characteristic cuts.

The two cuts most common to the jeweler are:

Chisel-Cut — Chisel-cut files are the best choice for fast removal as the cut or number of teeth per inch will be higher, however they tend to leave a rough surface. The angle of the chisel-cut is 52-72 degrees.

Edge-Cut — Edge-cut files are generally used for finishing or fine finishing according to the chosen cut or number of teeth per inch. They can run from about 22 teeth per inch in coarse-cut files. Numbers ranging from 00 to 4 grade files are used most by jewelers, 8 is the finest cut and will be requested by the watchmakers. The angle of the edge cut is 50-55 degrees.

Other cuts available to the jeweler are:

Single-Cut — Used on very thin sections of the work piece with lighter pressure. Available in needle file shapes in cut 2, equivalent to 96 teeth per inch, the most common cut for such applications.

Double-Cut — has two series of teeth, one series cuts in much the same manner as a single-cut file, and the second crosses over the first one with a 45-50 degree angle to shape the chip breaker and the teeth. The chip breaker will avoid having to long chip which may scratch the work piece.

Rasp-Cut — Usually confined to wax work.

FILE SHAPES

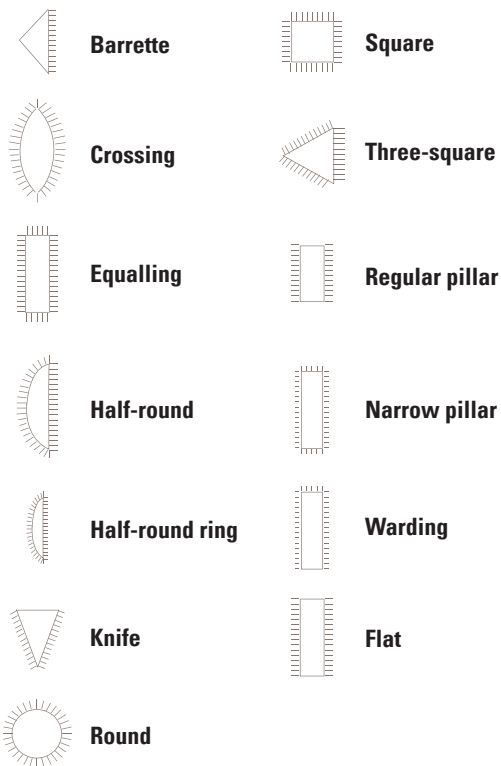

Scale of Cuts

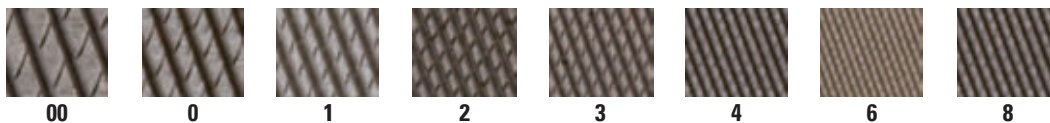

TEETH PER CM	12	16	20	25	31	38	46	56	68	84	116
TEETH PER INCH	30	41	51	64	79	97	117	142	173	213	295
Escapement Files				0		2		4	6		
Handle Files		00		1							
Needle Files			00	0	1	2	3	4	6		
Precision Files (w/tang) 10" / 250mm	00	0	1	2	3	4		6			
Precision Files (w/tang) 4"-8" / 100-200mm		00	0	1	2	3	4		6		
Precision Files 3" / 76mm			00	0	1	2	3	4		3	8
Rifflers, Die Sinkers				0		2		4			

FILE FACTS

- The most common sizes used by jewelers are from 6 to 8 inches for the tang files and 5½ to 6¼ inches for the needle files. The escapement files are available only in 5¼ inches.
- On difficult material, such as platinum, it is recommended that a coated file be used such as a Grobet USA Premium file. The coating will provide non-clogging on sticky materials.
- Files kept in drawers, where they can bang into or slide over one another, will result in dulling and chipping of the teeth. Files should always be kept in the original packaging.
- Never hold files by their teeth. Perspiration can cause the file to rust, and the oil from your skin can cause the file to skip.
- Files are designed to cut on the push stroke, or, better yet, the file should be lifted from the surface entirely to allow filings to fall from the teeth as well as to minimize dulling.
- Grease or oils can be removed through the application of chalk, which absorbs them.
- Files should never be oiled for use.

Files

**GROBET USA® WAX FILES**

Used for shaping waxes. Coarse, wide-tooth style does not clog as easily as conventional files. Set of six includes one of each shape sold in plastic pouch.



Order #	Description	Length	12+	6+	1+
33-9220	6-Piece Wax File Set	5½"	\$46.81	\$49.56	\$55.07

**DOUBLE-ENDED WAX FILE**

Double-end, double-cut file that has open, coarse teeth used for filing plastics, waxes, and soft materials. One end is coarser than the other.

Item	Order #	Length	Width	12+	6+	1+
A	31-3840	8"	14mm	\$35.66	\$37.76	\$41.95
B	31-3850	7"	12.7mm	\$25.71	\$27.23	\$30.25

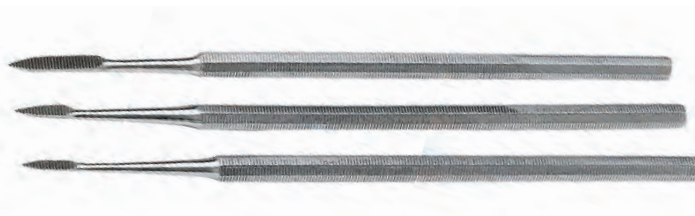
**WAX CARVING FILE SET**

Precision wax carving files with pointed tips for fine work. Each file features single cuts, which will not clog, but will leave a smooth surface. Made of stainless steel with Sure-Grip® Handles.

Order #	Description	Length	12+	6+	1+
33-9240	3-Piece Wax Carving Kit	5½"	\$14.88	\$15.75	\$17.50

SELECTING THE RIGHT FILE FOR THE JOB

In choosing the correct file for any application, three factors need to be considered: shape, size and cut. Shape and size are more a choice of application, but generally the shape of the file should match the contour of the object being filed. In selecting the cut, it is important to know that files are made in a range of tooth characteristic cuts.

The two cuts most common to the jeweler are:

Chisel-Cut — Chisel-cut files are the best choice for fast removal as the cut or number of teeth per inch will be higher, however they tend to leave a rough surface. The angle of the chisel-cut is 52-72 degrees.

Edge-Cut — Edge-cut files are generally used for finishing or fine finishing according to the chosen cut or number of teeth per inch. They can run from about 22 teeth per inch in coarse-cut files. Numbers ranging from 00 to 4 grade files are used most by jewelers, 8 is the finest cut and will be requested by the watchmakers. The angle of the edge cut is 50-55 degrees.

Other cuts available to the jeweler are:

Single-Cut — Used on very thin sections of the work piece with lighter pressure. Available in needle file shapes in cut 2, equivalent to 96 teeth per inch, the most common cut for such applications.

Double-Cut — has two series of teeth, one series cuts in much the same manner as a single-cut file, and the second crosses over the first one with a 45-50 degree angle to shape the chip breaker and the teeth. The chip breaker will avoid having to long chip which may scratch the work piece.

Rasp-Cut — Usually confined to wax work.

GROBET USA® GENUINE SWISS-PATTERN HAND FILES

Known and recognized worldwide as unsurpassed for exceptional durability. Extreme hardness due to chrome-alloy steel and unique manufacturing process.

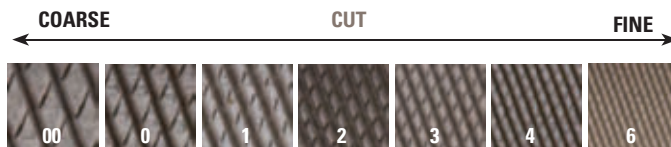

HALF-ROUND Tapered in width and thickness, coming to a point. Cut on both sides.

Order #	Cut	Width	Length	Thickness	12+	6+	1+
31-1110	00	5/8"	6"	1 1/4mm	\$25.46	\$26.96	\$29.95
31-1120	0	5/8"	6"	1 1/4mm	\$25.46	\$26.96	\$29.95
31-1131	1	5/8"	6"	1 1/4mm	\$27.16	\$28.76	\$31.95
31-1142	2	5/8"	6"	1 1/4mm	\$27.84	\$29.48	\$32.75

Order #	Cut	Width	Length	Thickness	12+	6+	1+
31-1153	3	5/8"	6"	1 1/4mm	\$29.71	\$31.46	\$34.95
31-1164	4	5/8"	6"	1 1/4mm	\$31.45	\$33.30	\$37.00
31-1176	6	5/8"	6"	1 1/4mm	\$47.60	\$50.40	\$56.00



HALF-ROUND RING Tapered in width and thickness, coming to a point. Useful in filing the inside of rings. Cut on both sides.

Order #	Cut	Width	Length	Thickness	12+	6+	1+
31-1271	00	3/4"	6"	9/64mm	\$27.63	\$29.25	\$32.50
31-1280	0	3/4"	6"	9/64mm	\$27.63	\$29.25	\$32.50
31-1291	1	3/4"	6"	9/64mm	\$28.48	\$30.15	\$33.50

Order #	Cut	Width	Length	Thickness	12+	6+	1+
31-1302	2	3/4"	6"	9/64mm	\$28.48	\$30.15	\$33.50
31-1313	3	3/4"	6"	9/64mm	\$29.33	\$31.05	\$34.50
31-1324	4	3/4"	6"	9/64mm	\$39.53	\$41.85	\$46.50



BARRETTE Tapered in width and thickness, coming to a point. Only flat side is cut, providing safe edge and top.

Order #	Cut	Width	Length	Thickness	12+	6+	1+
31-0271	00	5/8"	6"	4mm	\$19.34	\$20.48	\$22.75
31-0280	0	5/8"	6"	4mm	\$20.19	\$21.38	\$23.75
31-0291	1	5/8"	6"	4mm	\$22.74	\$24.08	\$26.75

Order #	Cut	Width	Length	Thickness	12+	6+	1+
31-0302	2	5/8"	6"	4mm	\$23.38	\$24.75	\$27.50
31-0314	4	5/8"	6"	4mm	\$26.14	\$27.68	\$30.75



REGULAR PILLAR Parallel in width and tapered in thickness. Perfect for inside square cuts and filing slots.

Order #	Cut	Width	Length	Thickness	12+	6+	1+
31-2430	00	3/4"	6"	5/32mm	\$15.34	\$16.25	\$18.05
31-2440	0	3/4"	6"	5/32mm	\$15.47	\$16.38	\$18.20
31-2451	1	3/4"	6"	5/32mm	\$16.24	\$17.19	\$19.10
31-2462	2	3/4"	6"	5/32mm	\$14.37	\$15.21	\$16.90

Order #	Cut	Width	Length	Thickness	12+	6+	1+
31-2473	3	3/4"	6"	5/32mm	\$17.43	\$18.46	\$20.51
31-2484	4	3/4"	6"	5/32mm	\$19.51	\$20.66	\$22.95
31-2496	6	3/4"	6"	5/32mm	\$29.45	\$31.19	\$34.65

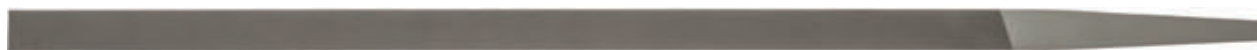

NARROW PILLAR These files are parallel in width and tapered in thickness to create perfectly flat filing. Double-cut top and bottom, both edges are safe.

Order #	Cut	Width	Length	Thickness	12+	6+	1+
31-2132	2	3/4"	6"	4mm	\$23.63	\$25.02	\$27.80

Files



CROSSING Half-round on two sides, with one side having a larger radius than the other. Tapered in width and thickness. Cut and usable to the point. Used primarily for filing interior curved surfaces.

Order #	Cut	Width	Length	Thickness	12+	6+	1+
31-0590	0	5/8"	6"	11/64mm	\$38.04	\$40.28	\$44.75
31-0602	2	5/8"	6"	11/64mm	\$40.80	\$43.20	\$48.00
31-0614	4	5/8"	6"	11/64mm	\$45.05	\$47.70	\$53.00



EQUALLING Parallel in width and thickness. Used primarily for filing slots and corners.

Order #	Cut	Width	Length	Thickness	12+	6+	1+
31-0680	00	3/4"	6"	3/32mm	\$19.34	\$20.48	\$22.75
31-0690	0	3/4"	6"	3/32mm	\$19.13	\$20.25	\$22.50
31-0702	2	3/4"	6"	3/32mm	\$19.98	\$21.15	\$23.50
31-0714	4	3/4"	6"	3/32mm	\$22.53	\$23.85	\$26.50

**PILLAR CHECKERING**

Order #	Cut	Width	Length	Thickness	12+	6+	1+
31-2118	0	3/4"	6"	4mm	\$32.94	\$34.88	\$38.75

**FLAT**

Parallel in width and thickness. One edge is safe.

Order #	Cut	Width	Length	Thickness	12+	6+	1+
31-1431	00	45/64"	6"	4mm	\$15.30	\$16.20	\$18.00
31-1440	0	45/64"	6"	4mm	\$16.24	\$17.19	\$19.10
31-1451	1	45/64"	6"	4mm	\$16.41	\$17.37	\$19.30
31-1462	2	45/64"	6"	4mm	\$16.49	\$17.46	\$19.40

Order #	Cut	Width	Length	Thickness	12+	6+	1+
31-1473	3	45/64"	6"	4mm	\$18.66	\$19.76	\$21.95
31-1484	4	45/64"	6"	4mm	\$20.53	\$21.74	\$24.15
31-1496	6	45/64"	6"	4mm	\$30.39	\$32.17	\$35.75

**THREE-SQUARE**

Gradually tapered, cut, and workable to the point.

Order #	Cut	Width	Length	Thickness	12+	6+	1+
31-3720	0	23/64"	6"	4mm	\$18.27	\$19.35	\$21.50
31-3731	1	23/64"	6"	4mm	\$18.27	\$19.35	\$21.50

Order #	Cut	Width	Length	Thickness	12+	6+	1+
31-3742	2	23/64"	6"	4mm	\$19.34	\$20.48	\$22.75
31-3754	4	23/64"	6"	4mm	\$21.68	\$22.95	\$25.50

**FILE CLEANER**

Steel, wire bristles mounted on wooden handle. Works great in removing small particles that clog teeth and reduce a file's ability to cut.

Order #	Length	12+	6+	1+
33-9810	10"	\$8.33	\$8.82	\$9.80



GROBET USA® PREMIUM HAND FILES

The highest execution standard on files. The surface has a Rockwell hardness of 72HRC, the hardest steel known. Will give a better performance on hard-to-file surfaces. Resistant to corrosion, no need to grease these files. Has a longer life than the standard file. An excellent file to use on platinum. Use 37-8794 file handle.

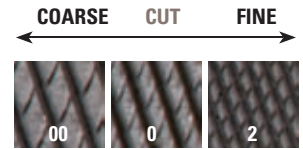

PILLAR

Order #	Cut	Length	Cutting Length	12+	6+	1+
31-8056	0	6"	5¼"	\$23.63	\$25.02	\$27.80

Order #	Cut	Length	Cutting Length	12+	6+	1+
31-8058	2	6"	5¼"	\$19.48	\$20.63	\$22.92



HALF-ROUND

Order #	Cut	Length	Cutting Length	12+	6+	1+
31-8060	0	6"	5¼"	\$34.85	\$36.90	\$41.00

Order #	Cut	Length	Cutting Length	12+	6+	1+
31-8062	2	6"	5¼"	\$34.85	\$36.90	\$41.00



HALF-ROUND SLIM

Order #	Cut	Length	Cutting Length	12+	6+	1+
31-8064	0	6"	5¼"	\$36.00	\$38.12	\$42.35

Order #	Cut	Length	Cutting Length	12+	6+	1+
31-8066	2	6"	5¼"	\$36.89	\$39.06	\$43.40



ROUND

Order #	Cut	Length	Cutting Length	12+	6+	1+
31-8068	0	8"	5¼"	\$17.81	\$18.86	\$20.95

Order #	Cut	Length	Cutting Length	12+	6+	1+
31-8070	2	8"	5¼"	\$19.51	\$20.66	\$22.95



THREE-SQUARE

Order #	Cut	Length	Cutting Length	12+	6+	1+
31-8072	0	8"	5¼"	\$23.76	\$25.16	\$27.95

Order #	Cut	Length	Cutting Length	12+	6+	1+
31-8074	2	8"	5¼"	\$23.76	\$25.16	\$27.95



SQUARE

Order #	Cut	Length	Cutting Length	12+	6+	1+
31-8076	0	8"	5¼"	\$19.55	\$20.70	\$23.00

Order #	Cut	Length	Cutting Length	12+	6+	1+
31-8078	2	8"	5¼"	\$22.64	\$23.97	\$26.63

**BARRETTE**

Order #	Cut	Length	Cutting Length	12+	6+	1+	Order #	Cut	Length	Cutting Length	12+	6+	1+
31-8048	0	6"	5¾"	\$29.54	\$31.28	\$34.75	31-8050	2	6"	5¾"	\$29.54	\$31.28	\$34.75

**HAND**

Order #	Cut	Length	Cutting Length	12+	6+	1+	Order #	Cut	Length	Cutting Length	12+	6+	1+
31-8052	0	6"	5¾"	\$20.15	\$21.33	\$23.70	31-8054	2	6"	5¾"	\$20.15	\$21.33	\$23.70

GROBET USA® PREMIUM NEEDLE FILES

The highest execution standard on files. The surface has a Rockwell hardness of 72HRC, the hardest steel known. Will give a better performance on hard-to-file surfaces. Resistant to corrosion, no need to grease these files. Has a longer life than the standard file. An excellent file to use on platinum. Use 37-8794 file handle.

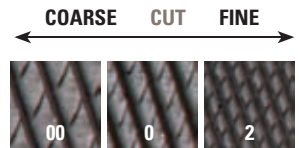
**BARRETTE**

Order #	Cut	Length	Cutting Length	12+	6+	1+	Order #	Cut	Length	Cutting Length	12+	6+	1+
31-8000	00	7"	3¼"	\$14.20	\$15.04	\$16.71	31-8004	6	7"	3¼"	\$14.24	\$15.08	\$16.75
31-8002	0	7"	3¼"	\$14.24	\$15.08	\$16.75							

**HALF-ROUND**

Order #	Cut	Length	Cutting Length	12+	6+	1+	Order #	Cut	Length	Cutting Length	12+	6+	1+
31-8012	00	7"	3¼"	\$16.10	\$17.05	\$18.94	31-8016	2	7"	3¼"	\$16.11	\$17.06	\$18.95
31-8014	0	7"	3¼"	\$16.11	\$17.06	\$18.95							

**EQUALLING**

Order #	Cut	Length	Cutting Length	12+	6+	1+	Order #	Cut	Length	Cutting Length	12+	6+	1+
31-8006	00	7"	3¼"	\$14.20	\$15.04	\$16.71	31-8010	2	7"	3¼"	\$14.24	\$15.08	\$16.75
31-8008	0	7"	3¼"	\$14.24	\$15.08	\$16.75							



GROBET USA® PREMIUM NEEDLE FILES

Made in Switzerland.

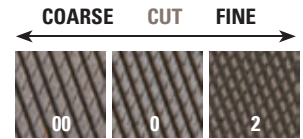

SQUARE

Order #	Cut	Length	Cutting Length	12+	6+	1+
31-8030	00	7"	3¼"	\$13.39	\$14.18	\$15.75
31-8032	0	7"	3¼"	\$13.39	\$14.18	\$15.75

Order #	Cut	Length	Cutting Length	12+	6+	1+
31-8034	2	7"	3¼"	\$13.39	\$14.18	\$15.75



THREE-SQUARE

Order #	Cut	Length	Cutting Length	12+	6+	1+
31-8024	00	7"	3¼"	\$13.39	\$14.18	\$15.75
31-8026	0	7"	3¼"	\$13.39	\$14.18	\$15.75

Order #	Cut	Length	Cutting Length	12+	6+	1+
31-8028	2	7"	3¼"	\$13.39	\$14.18	\$15.75



WARDING

Order #	Cut	Length	Cutting Length	12+	6+	1+
31-8018	00	7"	3¼"	\$13.39	\$14.18	\$15.75
31-8020	0	7"	3¼"	\$13.39	\$14.18	\$15.75

Order #	Cut	Length	Cutting Length	12+	6+	1+
31-8022	2	7"	3¼"	\$13.39	\$14.18	\$15.75



ROUND

Order #	Cut	Length	Cutting Length	12+	6+	1+
31-8036	00	7"	3¼"	\$13.36	\$14.15	\$15.72
31-8038	0	7"	3¼"	\$13.39	\$14.18	\$15.75

Order #	Cut	Length	Cutting Length	12+	6+	1+
31-8040	2	7"	3¼"	\$13.39	\$14.18	\$15.75

SIX "YELLOW TANG" FILES SET

For platinum, stainless steel, and other hard to file materials. Little to no clogging. Highly resistant to corrosion. Set includes one of each: barrette, equaling, half-round, three-squared, square, and round.



Order #	Cut	Length	Cutting Length	12+	6+	1+
31-8042	00	7"	3¼"	\$66.02	\$69.90	\$77.67
31-8044	0	7"	3¼"	\$66.00	\$69.89	\$77.65
31-8046	2	7"	3¼"	\$66.00	\$69.89	\$77.65

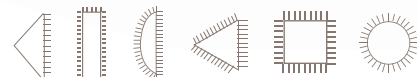

Files

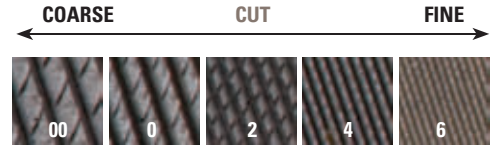
**ASSORTED NEEDLE FILES**

Sets consist of one each: barrette, crossing, equalling, half-round, joint round edge, knife, marking, round, splitting, square, 3-square, and warding files. Knurled handles.



Order #	Cut	Length	12+	6+	1+
31-2141	0	5½"	\$89.34	\$94.59	\$105.10
31-2142	2	5½"	\$89.34	\$94.59	\$105.10
31-2143	4	5½"	\$95.58	\$101.21	\$112.45

GROBET USA® NEEDLE FILES

Precision files for exacting work. Made of the highest quality steel, they are machined and finished for precision shape and balance.

**EQUALLING**

Order #	Cut	Length	12+	6+	1+
31-5120	0	7¾"	\$8.88	\$9.40	\$10.45
31-5132	2	7¾"	\$8.88	\$9.40	\$10.45

Order #	Cut	Length	12+	6+	1+
31-5144	4	7¾"	\$8.88	\$9.40	\$10.45

HALF-ROUND

Order #	Cut	Length	12+	6+	1+
31-5310	0	7¾"	\$11.01	\$11.66	\$12.95
31-5332	2	7¾"	\$11.01	\$11.66	\$12.95

Order #	Cut	Length	12+	6+	1+
31-5354	4	7¾"	\$11.86	\$12.56	\$13.95

THREE-SQUARE

Order #	Cut	Length	12+	6+	1+
31-6450	0	7¾"	\$9.18	\$9.72	\$10.80
31-6472	2	7¾"	\$9.18	\$9.72	\$10.80

Order #	Cut	Length	12+	6+	1+
31-6494	4	7¾"	\$9.82	\$10.40	\$11.55
31-6506	6	7¾"	\$28.01	\$29.66	\$32.95



KNIFE

Order #	Cut	Length	12+	6+	1+
31-5630	0	7¾"	\$11.01	\$11.66	\$12.95
31-5642	2	7¾"	\$11.01	\$11.66	\$12.95

Order #	Cut	Length	12+	6+	1+
31-5654	4	7¾"	\$11.01	\$11.66	\$12.95



ROUND

Order #	Cut	Length	12+	6+	1+
31-5970	0	7¾"	\$8.46	\$8.96	\$9.95
31-5982	2	7¾"	\$8.46	\$8.96	\$9.95

Order #	Cut	Length	12+	6+	1+
31-5994	4	7¾"	\$9.31	\$9.86	\$10.95



BARRETTE

Order #	Cut	Length	12+	6+	1+
31-4660	0	7¾"	\$9.78	\$10.35	\$11.50
31-4682	2	7¾"	\$9.78	\$10.35	\$11.50

Order #	Cut	Length	12+	6+	1+
31-4704	4	7¾"	\$10.16	\$10.76	\$11.95



CROSSING

Order #	Cut	Length	12+	6+	1+
31-4940	0	7¾"	\$10.16	\$10.76	\$11.95
31-4952	2	7¾"	\$10.16	\$10.76	\$11.95

Order #	Cut	Length	12+	6+	1+
31-4964	4	7¾"	\$11.86	\$12.56	\$13.95



EQUALLING

Order #	Cut	Length	12+	6+	1+
31-5051	00	6¼"	\$7.61	\$8.06	\$8.95
31-5060	0	6¼"	\$7.61	\$8.06	\$8.95
31-5082	2	6¼"	\$7.61	\$8.06	\$8.95

Order #	Cut	Length	12+	6+	1+
31-5104	4	6¼"	\$7.61	\$8.06	\$8.95
31-5116	6	6¼"	\$8.46	\$8.96	\$9.95



HALF-ROUND

Order #	Cut	Length	12+	6+	1+
31-5241	00	6¼"	\$8.88	\$9.40	\$10.45
31-5250	0	6¼"	\$8.88	\$9.40	\$10.45
31-5272	2	6¼"	\$8.88	\$9.40	\$10.45

Order #	Cut	Length	12+	6+	1+
31-5294	4	6¼"	\$8.93	\$9.45	\$10.50
31-5306	6	6¼"	\$12.03	\$12.74	\$14.15



Files

Files

GROBET USA® NEEDLE FILES

Grobet, genuine precision files.

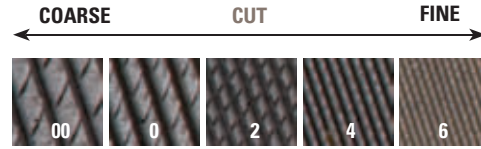

SQUARE

Order #	Cut	Length	12+	6+	1+
31-6191	00	6¼"	\$9.78	\$10.35	\$11.50
31-6200	0	6¼"	\$9.78	\$10.35	\$11.50
31-6222	2	6¼"	\$9.78	\$10.35	\$11.50

Order #	Cut	Length	12+	6+	1+
31-6244	4	6¼"	\$10.16	\$10.76	\$11.95
31-6256	6	6¼"	\$11.01	\$11.66	\$12.95



THREE-SQUARE

Order #	Cut	Length	12+	6+	1+
31-6371	00	6¼"	\$7.61	\$8.06	\$8.95
31-6380	0	6¼"	\$7.61	\$8.06	\$8.95
31-6402	2	6¼"	\$7.61	\$8.06	\$8.95

Order #	Cut	Length	12+	6+	1+
31-6424	4	6¼"	\$8.46	\$8.96	\$9.95
31-6436	6	6¼"	\$10.16	\$10.76	\$11.95



KNIFE

Order #	Cut	Length	12+	6+	1+
31-5580	0	6¼"	\$8.12	\$8.60	\$9.55
31-5592	2	6¼"	\$8.12	\$8.60	\$9.55

Order #	Cut	Length	12+	6+	1+
31-5614	4	6¼"	\$9.01	\$9.54	\$10.60
31-5626	6	6¼"	\$10.50	\$11.12	\$12.35



ROUND

Order #	Cut	Length	12+	6+	1+
31-5901	00	6¼"	\$7.14	\$7.56	\$8.40
31-5910	0	6¼"	\$7.14	\$7.56	\$8.40
31-5932	2	6¼"	\$7.14	\$7.56	\$8.40

Order #	Cut	Length	12+	6+	1+
31-5954	4	6¼"	\$7.74	\$8.19	\$9.10
31-5966	6	6¼"	\$8.16	\$8.64	\$9.60



BARRETTE

Order #	Cut	Length	12+	6+	1+
31-4581	00	6¼"	\$7.14	\$7.56	\$8.40
31-4590	0	6¼"	\$7.14	\$7.56	\$8.40
31-4612	2	6¼"	\$7.14	\$7.56	\$8.40

Order #	Cut	Length	12+	6+	1+
31-4634	4	6¼"	\$7.10	\$7.52	\$8.35
31-4646	6	6¼"	\$10.97	\$11.61	\$12.90



CROSSING

Order #	Cut	Length	12+	6+	1+
31-4900	0	6¼"	\$8.88	\$9.40	\$10.45
31-4912	2	6¼"	\$8.88	\$9.40	\$10.45

Order #	Cut	Length	12+	6+	1+
31-4924	4	6¼"	\$8.88	\$9.40	\$10.45
31-4936	6	6¼"	\$10.50	\$11.12	\$12.35



GROBET USA® ESCAPEMENT FILES

Grobet, genuine precision files. Known as the square handle needle file.

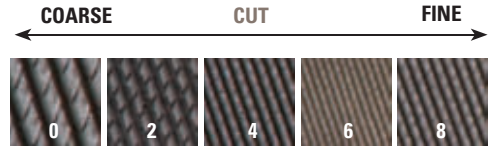

BARRETTE

Order #	Cut	Length	12+	6+	1+
31-7000	0	5½"	\$13.35	\$14.13	\$15.70
31-7012	2	5½"	\$13.35	\$14.13	\$15.70
31-7034	4	5½"	\$14.37	\$15.21	\$16.90

Order #	Cut	Length	12+	6+	1+
31-7046	6	5½"	\$15.13	\$16.02	\$17.80
31-7050	8	5½"	\$15.43	\$16.34	\$18.15



CROSSING

Order #	Cut	Length	12+	6+	1+
31-7142	2	5½"	\$14.37	\$15.21	\$16.90
31-7154	4	5½"	\$16.45	\$17.42	\$19.35

Order #	Cut	Length	12+	6+	1+
31-7166	6	5½"	\$16.28	\$17.24	\$19.15



EQUALLING

Order #	Cut	Length	12+	6+	1+
31-7202	2	5½"	\$12.33	\$13.05	\$14.50

Order #	Cut	Length	12+	6+	1+
31-7214	4	5½"	\$12.92	\$13.68	\$15.20



HALF-ROUND

Order #	Cut	Length	12+	6+	1+
31-7240	0	5½"	\$14.37	\$15.22	\$16.91
31-7252	2	5½"	\$14.41	\$15.26	\$16.95
31-7274	4	5½"	\$14.62	\$15.48	\$17.20

Order #	Cut	Length	12+	6+	1+
31-7286	6	5½"	\$15.43	\$16.34	\$18.15
31-7290	8	5½"	\$17.81	\$18.86	\$20.95



ROUND

Order #	Cut	Length	12+	6+	1+
31-7420	00	5½"	\$12.07	\$12.78	\$14.20
31-7432	2	5½"	\$12.07	\$12.78	\$14.20
31-7454	4	5½"	\$12.33	\$13.05	\$14.50

Order #	Cut	Length	12+	6+	1+
31-7466	6	5½"	\$12.33	\$13.05	\$14.50
31-7470	8	5½"	\$14.15	\$14.99	\$16.65
31-7526	6	5½"	\$9.89	\$9.89	\$9.89



THREE-SQUARE

Order #	Cut	Length	12+	6+	1+
31-7600	0	5½"	\$13.31	\$14.09	\$15.66
31-7612	2	5½"	\$13.35	\$14.13	\$15.70
31-7624	4	5½"	\$14.15	\$14.99	\$16.65

Order #	Cut	Length	12+	6+	1+
31-7636	6	5½"	\$15.34	\$16.25	\$18.05
31-7637	8	5½"	\$15.43	\$16.34	\$18.15



KNIFE

Order #	Cut	Length	12+	6+	1+
31-7336	6	5½"	\$18.53	\$19.62	\$21.80



THREE-SQUARE

Order #	Cut	Length	12+	6+	1+
31-7576	6	5½"	\$18.53	\$19.62	\$21.80
31-7625	0	5½"	\$13.09	\$13.86	\$15.40
31-7626	2	5½"	\$13.09	\$13.86	\$15.40

Order #	Cut	Length	12+	6+	1+
31-7627	4	5½"	\$14.03	\$14.85	\$16.50
31-7629	8	5½"	\$16.28	\$17.24	\$19.15



Q

R

COARSE CUT FINE



FILE SET

Habilis® files are the in-between files. Perfect for those jobs too large for the needle but too small for the regular file. Comes with built-in handle and are excellent for shaping. Sold in sets of 5.

Order #	Cut	Length	12+	6+	1+
33-8301	00	8½"	\$65.36	\$69.21	\$76.90
33-8302	1	8½"	\$59.63	\$63.14	\$70.15
33-8305	126 Grit Diamond				\$237.10

NEEDLE FILE SET

Contains one of each: barrette, crossing, equalling, half-round, round-edge, joint, knife, marking, round, slitting, square, three-square, and warding. All have knurled handles.



Order #	Cut	Length	12+	6+	1+
31-6790	0	6¼"	\$81.94	\$86.76	\$96.40
31-6802	2	6¼"	\$87.76	\$92.93	\$103.25
31-6814	4	6¼"	\$87.72	\$92.88	\$103.20
31-6828	6	6¼"	\$109.78	\$116.24	\$129.15

Shop Set Up SERVICE

Is your shop ready for a major renovation? Or, do a few pieces of equipment need updating?
Turn to Stuller's Tools Tech team to get the job done right.

We'll work with you to achieve the right balance of equipment, space, and budget to take your shop to the next level. Upgrade your technology and get more done in less time with improved safety measures.



POLISHING

Work with our team to setup the best polishing shop for your business. We will work with you to select the right equipment for the basic jobs while also keeping up with the latest technology.



CASTING

Control the entire jewelry making process by casting in your shop. Work with us to improve your casting processes by stocking up on the latest equipment for today's resins and waxes.



DIGITAL MANUFACTURING

Forge into the future of custom jewelry and create your customers' dream piece with the latest digital manufacturing technology. Increase your manufacturing and design capabilities by designing digitally.

What do our customers say?

Working with the Stuller team was a dream come true. We only had two and a half months before our target date for being open. The team provided everything we needed to equip our entire shop. All new state of the art equipment and tools!

I can say that the whole experience was typical Stuller. Everything was done on time and to absolute near perfection.

Dave Croad
CC Jewelers
Traverse City, MI

Call Stuller's Tools Tech Team at 1-800-877-7777, ext 4300.
They'll work with you to design your dream shop.



Files



ECONOMY NEEDLE FILE SET

May vary on individual file shapes and sizes.



Order #	Cut	Length	12+	6+	1+
31-6840	2	5½"	\$8.41	\$8.91	\$9.90



MASCOT® UTILITY FILE SET

Set consists of one of each of six American pattern file shapes: square, half-round, triangular, round, flat, and warding. Wooden file handle is treated with a smooth lacquer finish, which feels good in your hand. Performs wonderfully and even looks great on your workbench.



Order #	Length	Blade Length	12+	6+	1+
33-9235	7"	4"	\$9.99	\$10.58	\$11.75



4" MINI-NEEDLE FILE SET

Mini economy needle files to get into tight spots and tiny settings. Set may vary on individual shapes and sizes. Use with 37-8790 handle.



Order #	Cut	Length	12+	6+	1+
31-6852	2	4"	\$8.80	\$9.32	\$10.35



BROACHES SET

Set of six broaches with plastic handles. Sizes included are Numbers 46 through 72 according to English Stubs Gauge. Five-sided. Has a regular taper and perfect finish. Used for general purpose work such as cutting, cleaning, and finishing. Made in Germany.



Order #	Stub Range	12+	6+	1+
15-5060	43-72	\$13.09	\$13.86	\$15.40

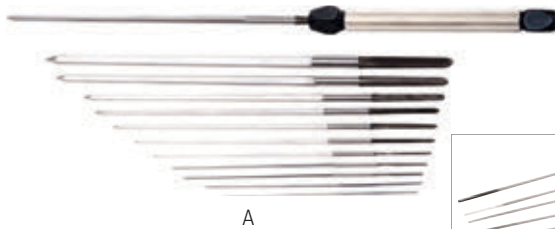

A

B



ASSORTMENT BROACH CUTTING SETS

Pen-sized aluminum holder/handle with 3/8" diameter anodized barrel and pocket clip. Holds 5½" diamond needle files with shortened shanks that are stored in the barrel. Handle has non-slip finger grip surface for positive control. An easy, convenient way to keep files at your fingertips. Round broach set for general purpose work.



Item	Order #	Style	Stub Range	12+	6+	1+
A	15-5050	Cutting	15-70	\$35.10	\$37.17	\$41.30
B	15-5055	Round	55-80	\$29.58	\$31.32	\$34.80



DOUBLE-ENDED RIFFLER FILE SET

Six-inch long, double-ended, riffler files. Shipped in a vinyl pouch for convenience. Note: Use proper eye protection.



Order #	Length	12+	6+	1+
31-9910	6"	\$13.22	\$14.00	\$15.55

DIAMOND NEEDLE FILE SET

Made of fine steel with a diamond coating used for precision filing jobs. The diamond particles are electroplated onto the surface of the metal.



Order #	Description	Length	12+	6+	1+
33-9500	Medium Grit Needle File Set	5½"	\$36.55	\$38.70	\$43.00

INDIVIDUAL FILES

33-9501	Equalling	5½"	\$9.27	\$9.82	\$10.91
33-9502	Three-Square	5½"	\$9.27	\$9.81	\$10.90
33-9503	Half-Round	5½"	\$9.27	\$9.81	\$10.90
33-9504	Square	5½"	\$9.27	\$9.81	\$10.90
33-9505	Round	5½"	\$9.27	\$9.81	\$10.90

**3M® DIAMOND FILE SET**

Diamond files can cut your finishing time in half. These flex diamond files are made of a rigid plastic with flex diamond laminate on the surface. These files are ideal for handwork on small and difficult to reach areas. There is no better sanding tool on the market for the price.

Shapes in set:

- Flat (¾" x 1½")
- Flat (¼" x 2½")
- Flat (½" x 1¾")
- Half Round (¾" x 1¾")

Order #	Color	Grit	Micron	12+	6+	1+
10-8071	Red	200	74 μ	\$29.11	\$30.83	\$34.25

**FILE HANDLES**

Item	Order #	Description	12+	6+	1+
A	37-7856	Skroo-Zon Wooden Handle (6" Files Only)	\$2.64	\$2.79	\$3.10
B	37-7846	Threaded Plastic File Handle	\$3.27	\$3.47	\$3.85

NEEDLE FILE HANDLES

C	37-8336	Hardwood for Metal Ferrule 4" x 5/8"	\$0.94	\$0.99	\$1.10
D	37-8330	Hardwood for Metal Ferrule 4" x 3/8"	\$0.94	\$0.99	\$1.10

**ALUMINUM FILE HANDLES**

These needle-file handles are an entirely different approach to file handles. Handles are made of high-grade, anodized aluminum with steel chucks and are knurled for ease of handling. The steel chucks are fixed into the shaft so when the knurled sleeve is unscrewed, the chuck will quickly release the file. This handle could possibly be the needle-file handle to last a lifetime. These handles have been tested and found superior to all other handles.

Item	Order #	Needle File	Length	Diameter	12+	6+	1+
E	37-8790	4"	4½"	3/8"	\$7.27	\$7.70	\$8.55
F	37-8792	5½" - 6¼"	4½"	½"	\$7.99	\$8.46	\$9.40
G	37-8794	6¼" - 7¾"	4½"	½"	\$8.12	\$8.60	\$9.55



FOREDOM



FOREDOM® 2220 JEWELER'S KIT

The 1/6 HP reversible SR Motor with FCT foot-operated speed control, H.20 Handpiece with chuck key, and 43-piece accessory kit offers superior performance and combines all of the features expected. H.20 Handpiece comes with a 1.5mm allen wrench to adjust collet tension. SR Motor operates in both forward and reverse rotation and comes with a standard 39" inner and outer sheath and shaft.

Item	Order #	Description	1+
A	34-2242	SR Motor with H.20 Handpiece	\$245.00
B	34-2375	H.20 Handpiece	\$82.50
C	34-2157	Motor Maintenance Kit 10	\$16.95



FOREDOM® 2220 JEWELER'S KIT

The 1/6 HP reversible SR Motor with FCT foot-operated speed control, H.30 Handpiece with chuck key, and accessory kit offers superior performance and combines all of the features expected. Operates in both forward and reverse rotation.

Item	Order #	Description	1+
D	34-2243	SR Motor with H.30 Handpiece	\$229.00
ACCESSORIES			
E	34-2215	H.30 Handpiece	\$47.00
F	34-2158	Motor Maintenance Kit 8	\$16.95



FOREDOM® TX300 JEWELER'S KIT

The TX permanent-magnet DC 1/3 HP motor delivers more torque and complete control than any other flexible shaft power tool. The TX has more torque in the low, medium, and full-speed ranges than standard motors. It offers smooth and controlled acceleration. Ideal for stone setting, wax carving, and high-speed polishing. Kit Includes:

- TX Permanent-Magnet Motor, 1/3 HP
- H.30 Handpiece with chuck key
- TXR Foot-Operated Speed Control
- 43-piece accessory kit

Item	Order #	Description	1+
G	34-2255	TX300 Motor with H.30 Handpiece	\$279.00
H	34-2215	H.30 Handpiece	\$47.00
ACCESSORIES			
J	34-2286	TXR Foot Control	\$47.65
K	34-2156	Maintenance Kit 16	\$21.15





FOREDOM® STONE SETTING KIT

This high-torque/low-speed motor and Quick Change handpiece combination make this an ideal kit for stone setting, drilling, and other low-speed applications.

Kit includes:

- LX Permanent-Magnet Motor high-torque/low-speed, 5,000 RPM
- H.18 Quick Change Handpiece
- TXR Foot-Operated Speed Control
- Accessory kit tray

Item	Order #	Description	1+
A	34-2240	Stone Setting Kit	\$329.95

ACCESSORIES

B	34-2213	H.18 Handpiece	\$120.00
C	34-2156	Maintenance Kit 16	\$21.15



FOREDOM® POWERGRAVER KIT WITH SETTING ACCESSORIES

Ideal for bead, prong, channel, hammer, and bezel setting as well as engraving and other decorative work. The PowerGraver provides a power assist to stone setting and engraving operations. The 2293 PowerGraver kit is a dedicated system with specialized components. Its new permanent magnet Series PGX (formerly PG) motor is designed for high torque-low speed applications with permanently lubricated ball bearings for quiet, trouble-free performance. The 9D handpiece works and feels like a hand engraving tool with the advantages of greater control and the ability to adjust the impact force. The unit comes equipped with a special, extra flexible neoprene sheath and a 6' long power cord. A DVD with 32 minutes of instruction for using the PowerGraver is included, along with a set of accessories and maintenance items. Two-year warranty of PowerGraver Motor. Accessories included in kit: carbide stylus, anvil point, and a set of four gravers (#52 round, #3 onglotte, #2 bevel, and #40 flat).

Item	Order #	Description	1+
D	34-2293	PowerGraver Kit	\$395.00

ACCESSORIES

E	34-2131	Carbide Stylus	\$32.80
F	34-2130	Anvil Point	\$6.90



FOREDOM® H 9D HANDPIECE

This special, chuck-type handpiece fits only the PowerGraver. Adjusting ring changes impact force, and included palm rest provides comfort and "feel" of hand engraving tool. Comes with three interchangeable collets (1/16", 3/32", 1/8").

Item	Order #	Description	1+
G	34-2294	H 9D Handpiece	\$182.00



FOREDOM® MOTORS

All motors come with a 39" long shaft in a protective sheath with a steel liner and silencer. The TX motor requires a special, speed control that cannot be used on other models. Comes with sheath. One-year warranty. Ball Bearing motor. Runs up to 18,000 RPM. Operates in forward and reverse.

Item	Order #	Description	HP	RPM	1+
H	34-2257	TX Motor	1/8	15,000	\$215.00
J	34-2241	SR Motor	1/8	18,000	\$169.95



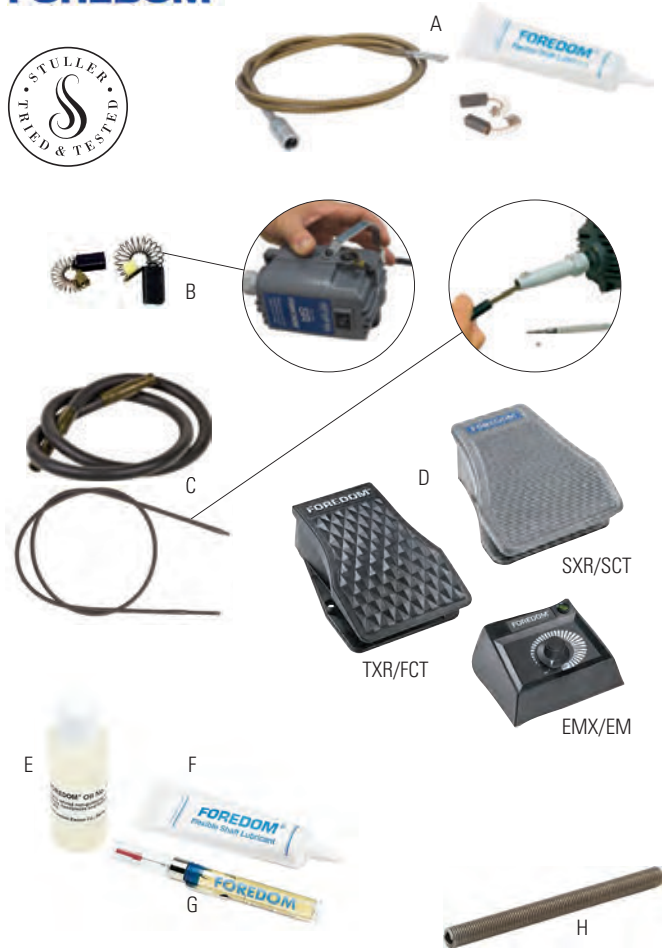

FOREDOM® MAINTENANCE KITS AND SUPPLIES

A. Motor Maintenance Kits. Your flex shaft will likely require replacement shafts and sheaths during its lifetime. Motor specific kits come packed with a shaft, motor brushes, and grease.

B. Motor Brushes. Motor brushes come in pairs and should be replaced for optimal machine performance when worn to ¼ inch in length. Be sure to watch our video for help with replacing motor brushes.

C. Shafts and Sheaths. You can expect to replace inner shafts and outer sheaths over the course of your machine's life. There are various types for different machines.

D. Speed Controls. Speed controls are required to operate a Foredom flexible shaft machine and allow the user to vary speed from low to full. Motors connect to speed controls and not directly into an electrical outlet. The 6' long speed control power cord plugs into an outlet.

LUBRICANTS

Item	Order #	Description	Size	1+
E	34-2259	Motor/Handpiece Oil	2 oz	\$4.00
F	34-2260	Flexible Shaft Grease	1 oz	\$4.00
G	34-2279	Hypodermic Oiler		\$4.40

DUPLEX SPRING

Item	Order #	Description	1+
H	34-2307	Spring for Duplex	\$10.00

Flex Shafts

Order #	Description	1+	CC	CC	DD	EE	GG	H	HB	K	L	LB	MM	MMG	PG	R	RB	S	SB	SM	SR	SRB	SRM	TX	TXB	TXGH	TXH	TXM	TXMH
34-2158	A. Motor Maintenance Kit 8	\$16.95																	•	•	•	•	•						
34-2159	Maintenance Kit 9	\$16.95	•		•								•																
34-2157	Motor Maintenance Kit 10	\$16.95																				•							
34-2156	Maintenance Kit 16	\$21.15									•													•					
34-2261	B. Motor brushes	\$8.50	•		•	•							•						•			•							
34-2262	Motor brushes	\$8.50		•		•	•							•			•	•											
34-2263	Motor brushes	\$12.15									•				•									•	•	•	•	•	•
34-2254	Motor brushes	\$8.50						•	•	•									•	•	•	•	•						
34-2270	C. Inner shaft	\$10.60	•			•	•	•			•	•				•	•	•				•		•					
34-2274	Inner shaft	\$10.60			•	•							•																
34-2277	Standard sheath	\$15.25			•	•							•																
34-2271	Standard sheath	\$14.50	•			•	•	•			•	•				•	•	•				•		•					
34-2273	Neoprene sheath	\$18.40	•			•	•	•			•	•				•	•	•				•		•					
34-2297	60 in. HD sheath	\$64.95																			•			•					
34-2308	Connector CC-DD	\$3.40	•																										
34-2309	Connector EE-GG	\$3.50			•	•																							
34-2280	D. FCT Foot control	\$34.90	•								•			•					•			•							
34-2286	TXR Foot Control	\$47.65																						•					
34-2281	SCT Foot control	\$66.75	•								•								•			•							
34-2289	SXR Foot control	\$66.75	•								•								•										
34-2283	EM Manual control	\$66.75	•								•								•										
34-2295	EMX Manual control	\$79.45																											

GROBET USA® S-300 MOTOR

A. Versatile flex shaft machine with ball bearing motor runs smooth and requires no lubrication. One-year replacement warranty. Includes S-300 motor, foot pedal, and No. 30 handpiece.

B. Includes S-300 motor with quick change handpiece kit.

C. Includes C-300 motor with quick change handpiece kit.

FLEX SHAFT MAINTENANCE KIT

Includes tube of flexible shaft lubricant (grease) and a set of replacement motor brushes.



Item	Order #	Description	HP	1+
A	34-2325	S-300 Motor with #30 Handpiece	1/8	\$119.00
B	34-2319	S-300	1/8	\$109.95
C	34-2327	C-300	1/10	\$89.00
D	34-2251	Maintenance Kit		\$16.95

ACCESSORIES

E	34-2346	Inner Shaft		\$8.15
F	34-2347	Outer Shaft		\$9.20

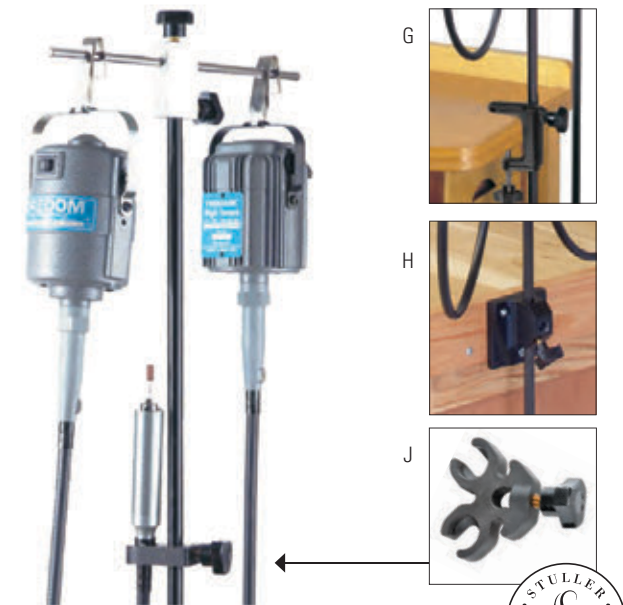
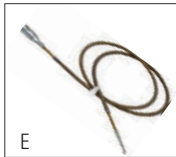

FLEXSHAFT DOUBLEMOTOR HANGERS

Convenient stand used to hold or hang up machines. Attaches to workbench, allowing more working space. Both models include a handpiece rest and t-rod, which can accommodate two motors. Full swivel with locking screw.

Item	Order #	Description	1+
G	34-2275	Foredom Hanger with Clamp	\$47.00
H	34-2276	Foredom Hanger with Base	\$69.00
J	34-2267	Handpiece Rest	\$9.20



MOTOR HANGERS

Convenient stand used to hold or hang up machines. Attaches to workbench, allowing more working space. Both models include a handpiece rest and t-rod, which can accommodate two motors. Full swivel with locking screw.

Item	Order #	Description	1+
K	34-6110	Adjustable Flex Shaft Holder	\$28.15
L	34-6112	Double Flex Shaft Holder	\$32.00



A

HANDPIECE HOLDER

Convert your flex shaft machine into a polishing lathe. A convenient way to hold your handpiece while polishing, grinding, sanding, and carving. The handpiece holder comes complete with a handpiece clamp, rod, and bench clamp. Adjustable height up to 10". The bench clamp adjusts to bench top thicknesses up to 2 1/4". Fits handpieces No. 30, No. 304, No. 44, No. 44T, and No. 44HT.

Item	Order #	Description	1+
A	34-2268	Handpiece Holder	\$41.00



B

QUICK CHANGE HANDPIECE

Ergonomic design provides improved control and extra comfort. Release lever for use with 3/32" (2.4mm) shanks.

Item	Order #	Description	1+
B	34-2402	Quick Change Handpiece	\$65.60



C

PLASTIC CHUCK KEY HANDLE

For No. 30, No. 30SJ, No. 25C, and No. 30H handpiece users.

Item	Order #	Description	1+
C	28-2114	Plastic Chuck Key with Handle	\$6.00

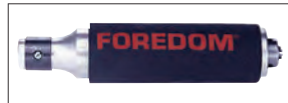

FOREDOM® CUSHION HANDLE

This foam, hand-fitted cushion fits nicely on the No. 30 and No. 44 Foredom handpieces. Makes those long hours of drilling go by quickly.

Order #	Description	1+
34-2266	Cushion Handle	\$2.65



D

GROBET USA® QUICK CHANGE HANDPIECE

Special design provides better control and extra comfort. Quick Change lever for use with 3/32" shank.

Item	Order #	Description	1+
D	34-2354	Handpiece	\$144.60
E	34-2355	Handpiece with Duplex Spring	\$224.55



E

GROBET USA® GENERAL PURPOSE HANDPIECE

The most popular handpiece for all-around use. Chuck takes accessory shanks for 0 to 5/32" (0 to 4mm). Includes chuck key.

Item	Order #	Description	1+
F	34-2356	General Purpose Handpiece	\$34.75
G	28-2114	Plastic Chuck Key with Handle	\$6.00



F



G



H

SWISS TECHNIQUE HANDPIECE

Ideal for fast precision work that requires quick tool changes. The quick release collet can be opened even while the tool is spinning. Comes with a 3/32" collet. Shaped for the hand, vibration free, and has an all-metal dust-proof casing. Made in Switzerland.

Item	Order #	Description	Size	1+
H	34-2299	Rotary Handpiece		\$190.00
J	34-2303	Collet (replacement part)	3/32"	\$35.00
K	34-2304	Collet (replacement part)	1/8"	\$35.00



J



K

FOREDOM®**FOREDOM® H.52 AND H.52D QUICK CHANGE HANDPIECES**

Quick release, push-pull action handpieces allow users to simply push to open chuck, insert tool, and then pull to close and lock. Made of a durable plastic barrel and grip with pre-lubed ball bearings. H.52 and H.52D handpieces to accept 3/32" (2.35mm) shank.

Item	Order #	Description	1+
A	34-2360	H.52 Handpiece	\$122.00
B	34-2361	H.52D Handpiece with Duplex Spring	\$135.00

**FOREDOM® H.8 AND H.8D HANDPIECES**

Handpiece is anodized aluminum with tapered grip only 1/2" thick for comfortable fingertip control. Included are both 3/32" and 1/8" collets. Pin wrench also included. Permanently sealed, maintenance-free ball bearings make this an excellent alternative for continuous use.

Item	Order #	Description	Size	1+
C	34-2207	H.8 Handpiece		\$61.40
D	34-2208	H.8D Handpiece		\$82.20

REPLACEMENT PARTS

E	34-2100	Collet Set of 4 (34-2101 to 34-2104)		\$27.60
	34-2103	Collet	3/32"	\$7.75

**FOREDOM® H.10 AND H.10D HANDPIECES**

Quick release lever action for rapid accessory changes. Pre-lubricated ball bearings require no maintenance. Accepts 3/32" (2.35mm) shank.

Item	Order #	Description	1+
F	34-2209	H.10 Handpiece	\$245.00
G	34-2210	H.10D Handpiece	\$265.00
H	34-2219	Collet	\$46.50

**FOREDOM® H.20 AND H.20D HANDPIECES**

The H.20 handpiece has a plastic molded front grip with tapered sides for easy handling. It has pre-lubricated ball bearings that do not require maintenance. A lever action handle is all that is required to change accessories. For use with 3/32" (2.35mm) shank burs.

Item	Order #	Description	1+
J	34-2375	H.20 Handpiece	\$82.50
K	34-2376	H.20D Handpiece	\$85.00
L	34-2377	Collet	\$11.60

**FOREDOM® STONE SETTING KIT**

Handpiece with exclusive Quick Change press-to-release collet. Ideal for stone setting and other applications requiring frequent bur changes. Slimmer grip for fingertip control. Accepts 3/32" (2.35mm) shank accessories. Pre-lubricated ball bearings require no maintenance.

Item	Order #	Description	1+
M	34-2213	H.18 Handpiece	\$120.00
N	34-2214	H.18D Handpiece	\$129.00
P	34-2310	Collet	\$29.25

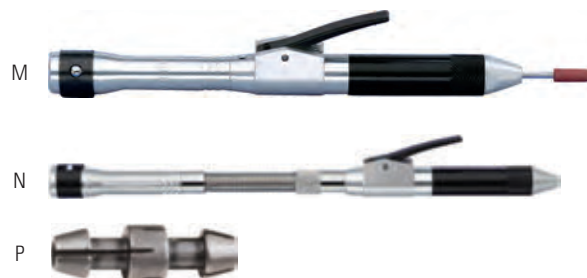

FOREDOM®



FOREDOM® H.44T AND H.44HT HANDPIECES

Tapered-grip handpieces with a collet-type chuck that adapts to accessories up to 1/4". Pre-lubricated ball bearings require no maintenance. H.44T includes a pin, wrench, and three collets (3/32", 1/8", and 1/4"). H.44HT includes a pin, wrench, and two collets (1/8" and 1/4"). Designed for use with the Foredom® H Flex Shaft system.

Item	Order #	Description	Inside Diameter	1+
A	34-2217	H.44T Handpiece		\$49.00
B	34-2218	H.44HT Handpiece		\$52.00

REPLACEMENT PARTS

C	34-2110	Collet Set of 7 (41-444 to 447-449)		\$49.65
	34-2113	Collet	3/32"	\$8.00
	34-2114	Collet	1/8"	\$8.00
	34-2115	Collet	5/32"	\$8.00

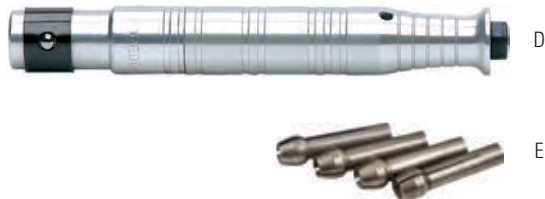

FOREDOM® H.8 AND H.8D HANDPIECES

Handpiece is anodized aluminum with tapered grip only 1/2" thick for comfortable fingertip control. Included are both 3/32" and 1/8" collets. Pin wrench also included. Permanently sealed, maintenance-free ball bearings make this an excellent alternative for continuous use.

Item	Order #	Description	1+
D	34-2370	H.28 Handpiece	\$49.00
E	34-2100	Collet Set of 4 (34-2101 to 34-2104)	\$27.60

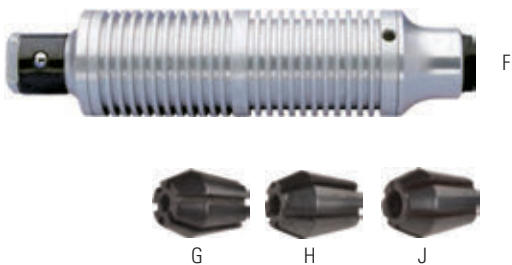

FOREDOM® H.35 HANDPIECE

Precision, high-speed handpiece with unique, planetary drive that produces 2 1/2 times the speed of the motor. This feature makes it the perfect tool for bright cutting with diamond flywheels and for other high-speed work with carbide and diamond points. Seven collets are available ranging from 1/16" to 3/16" including metric sizes. Pre-lubricated, double shielded, ball bearings rated for speeds to 35,000 RPM and comes with 1/8" collet (unless other size is specified). Recommended motor speed is 14,000 RPM.

Item	Order #	Description	Inside Diameter	1+
F	34-2216	H.35 Handpiece		\$147.50

REPLACEMENT PARTS

G	34-2135	Collet	3/32"	\$20.25
H	34-2138	Collet	1/16"	\$20.25
J	34-2139	Collet	3/8"	\$20.25



FOREDOM® H.30 AND H.30H HANDPIECES

Excellent in quality and popular for its general purpose use, these handpieces feature three-jaw Jacob® style chuck that fits shanks from 0" to 5/32". Pre-lubricated ball bearings require no maintenance. H.30H This heavy-duty handpiece is designed for use with the Foredom H Flex Shaft system. Chuck key included with all models.

Item	Order #	Description	1+
K	34-2220	H.30H Handpiece	\$62.50
L	34-2215	H.30 Blue	\$47.00
M	34-2215	H.30 Pink	\$47.00
N	34-2215	H.30 Handpiece	\$47.00
P	28-2114	Plastic Chuck Key with Handle	\$6.00



FOREDOM® HAMMER STONE SETTING KIT

This high-torque/low-speed motor and Quick Change handpiece combination make this an ideal kit for stone setting, drilling, and other low-speed applications. Kit Includes:

- LX Permanent-Magnet Motor, high-torque/low-speed, 5,000 RPM
- H15 Hammer Quick Change Handpiece with anvil point, pavé point, and carbide styles
- TXR Foot Speed Control - Tray



Item	Order #	Description	Style	1+
A	34-2250	Stone Setting Kit		\$359.95

TIPS

B	34-2130	Anvil Point	Flat	\$6.90
C	34-2131	Carbide Stylus	Point	\$32.80
D	34-2132	Pavé	Pavé Point	\$38.55

FOREDOM® H.15 AND H.15D HANDPIECES

Hammer handpiece used by professional jewelers for stone setting and decorative work. Has 1/2" stroke with adjustable impact and comes with an anvil point (34-2130). Can also be used with pavé point (34-2132) for special texturing. A stylus (34-2131) with pointed, carbide tip is available for texturing, marking, or scribing hardened steel. Recommended for use with LX Motor at speeds of 0-5,000 RPM. 1/2" diameter at tip, 6" long, and 4 oz.



Item	Order #	Description	Style	1+
E	34-2211	H.15 Handpiece		\$110.00
F	34-2212	H.15D Handpiece		\$125.00

TIPS

G	53-1905	Diamond	Texturing	\$36.70
H	34-2130	Anvil Point	Flat	\$6.90
J	34-2131	Carbide Stylus	Point	\$32.80
K	34-2132	Pavé	Pavé Point	\$38.55



GROBET USA® HAMMER-STYLE HANDPIECE

Designed to hit hard under control without excessive heat build-up.



Item	Order #	Description	1+
L	34-2351	Hammer HP	\$182.00
M	34-2352	Hammer HP with Duplex Spring	\$223.55
N	34-2353	Hammer Point	\$5.40



SWISS HAMMER HANDPIECE

Lightweight slender aluminum body with a hardened steel inside mechanism. Comes with one screw-in cylinder non-hardened point.

Item	Order #	Description	Style	1+
P	34-2298	Hammer Handpiece		\$215.00

TIPS

Q	53-1905	Diamond	Texturing	\$36.70
R	34-2130	Anvil Point	Flat	\$6.90
S	34-2131	Carbide Stylus	Point	\$32.80
T	34-2132	Pavé	Pavé Point	\$38.55





Badeco Micromotor Kits

This Swiss-made system is an investment for your shop. One tool does it all. Relying on quick-change technology, you'll move from rotary to reciprocating to hammer with ease. Enjoy smooth control with the convenient foot pedal. It replaces your flex shaft. Call us today to learn how you can add speed to your shop today with Badeco.



A

Kit 1

Includes:

- Pedal
- Control unit
- Handpiece holder
- 450 quick-change handpiece



B

Kit 2

All items from Kit 1, plus:

- A controller that will hold up to three handpieces
- Two additional quick-change handpieces



C

Kit 3

All items from Kit 1, plus:

- A controller that will hold all four handpieces
- Three additional quick-change handpieces

BADECO MICROMOTOR KIT 1

Badeco micromotor kit 1 comes complete with a control unit, one micromotor, handpiece, and a foot pedal. Features include speed and rotation control, and hand or foot control.

Item	Order #	Description	1+
A	34-2380	Badeco Micromotor Kit 1	\$1,899.00

BADECO MICROMOTOR KIT 2

Badeco micromotor kit 2 comes complete with a control unit, three micromotors, three handpieces, and a foot pedal. Features include speed and rotation control, and hand or foot control.

Item	Order #	Description	1+
B	34-2381	Badeco Micromotor Kit 2	\$2,900.00

BADECO MICROMOTOR KIT 3

Badeco micromotor kit 3 comes complete with an arm, control unit, four micromotor handpieces, and a foot pedal. Special features of this system include speed control, direction rotation control, automatic selection of micromotors, and speed control for four micromotors with one pedal. Just pull a handpiece out of its holster and that handpiece is ready for use.

Item	Order #	Description	1+
C	34-2382	Badeco Micromotor Kit 3	\$3,800.00

POWER MICROMOTOR

The 20,000 RPM micromotor is used with the Badeco micromotor kits 1, 2, and 3 (34-2380, 34-2381, and 34-2382).

Order #	Description	Inside Diameter	RPM	1+
34-2383	Power Micromotor	26 mm	20,000	\$579.00

**HANDPIECES FOR POWER MICROMOTOR**

All of these handpieces can be used with the power micromotor 34-2383.

Item	Order #	Description	RPM	1+
A	34-2384	Micropolishing Quick Exchange Handpiece	500-5,000	\$564.30
B	34-2385	Quick Exchange Handpiece	20,000	\$395.00
C	34-2386	Exchangable Collet Handpiece	20,000	\$386.50
D	34-2387	Rivetting and Setting Mallet Handpiece	8,000	\$564.30

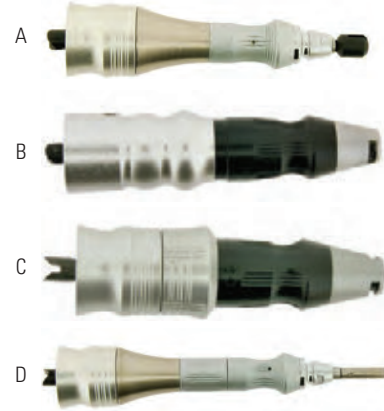
**QUICK EXCHANGE HANDPIECE**

The Badeco quick change hand piece is used with your flexshaft. It is robust and handy and allows for quick clamping and unclamping. The hand piece has 3 ball bearings and is good for speeds up to 20,000 rpm.

Order #	Description	RPM	1+
34-2396	Quick Exchange Handpiece	20,000	\$323.70

**RIVETTING AND SETTING Mallet**

The Badeco quick exchange rivetting and setting mallet is used with your flexshaft and is a high precision quality mallet that is robust and handy. The handpiece allows the user to stroke up to 8,000 strokes per minute, delivered with an unhardened point.

Order #	Description	RPM	1+
34-2397	Rivetting and Setting Mallet	8,000	\$246.90

**MINI POLISHING AND FILLING QD HANDPIECE**

The Badeco Mini Polishing/Filing hand piece works with your flexshaft and performs a reciprocating action. Great for use with ceramic stones. Stroke length is 1mm, speed is 500-7,000 strokes per minute.

Order #	Description	RPM	1+
34-2399	Mini QD Handpiece	500-7,000	\$411.45

**QUICK EXCHANGE HANDPIECE**

The Badeco quick exchange handpiece is used with your flexshaft. It is robust and handy and allows for quick clamping and unclamping. The hand piece has 3 ball bearings and is good for speeds up to 20,000 RPM.

Order #	Description	RPM	1+
34-2398	Quick Exchange Handpiece	20,000	\$323.70





BADECO SWISS HANDPIECE

Top-quality, high-precision handpieces designed for rugged use.

Two models available. Made in Switzerland.

Badeco Hammer Handpiece

- Adjustable striking force
- Robust and handy
- 3,000 strokes per minute
- Comes with 3/32" collet

Order #	Description	1+
34-2190	Hammer HP with Spring	\$375.00



SILENTAIRE AIR COMPRESSOR

The Silentaire air compressor is virtually noiseless and is totally automatic. Unit includes a tank, line pressure gauge, line pressure regulator, moisture trap/filter/gauge, safety valve, air intake filter, and a carrying handle. The SIL-AIR models feature a heavy duty 1/2hp pump for reliability and durability.

Item	Order #	Description	1+
A	14-5000	4 gallon Compressor (1/2 hp)	\$1,065.90
	14-4999	6 gallon Compressor (1/2 hp)	\$1,149.90

ACCESSORIES

B	14-5002	24 oz Compressor Oil	\$22.80
C	14-5001	Hook-Up Hose (50' x 1/4")	\$42.35
	14-4492	Air Intake Filter	\$19.50
	14-4493	Filter Element (Pack of 4)	\$13.60
	14-4494	Filter Regulator WI	\$83.75
	14-4495	Pressure Gauge 1/8" - Rear	\$26.00
	14-4496	Filter Element WI	\$26.00
	14-4497	Filter Kit N Coalescent	\$47.20



AIR FILTER/OIL REMOVAL KIT

A must for GRS® equipment when using an oil lubricated compressor.

Removes dirt and oil contamination from compressed air.

Item	Order #	Description	1+
D	14-5004	Air Filter / Oil Removal Kit	\$105.95



QUICK DISCONNECT KIT

Saves time by letting you switch from one GRS® Handpiece to another in seconds. Includes main body and two handpiece connectors.

Item	Order #	Description	1+
E	14-5005	Quick Disconnect Kit	\$31.75



CHICAGO PNEUMATIC AIR SCRIBE®

Lightweight air scribe that is ideal for engraving, texturing, or deburring. Capable of marking material as hard as RC-64. Accurate throttle selection can be made by adjusting the sleeve valve. Operates on less than 1 CFM. Requires an air compressor and filter/regulator (which are not included). Comes with Stylus and 8 ft. of reinforced hose. Foot pedal sold separately.

Item	Order #	Description	1+
F	26-4055	Pneumatic Air Scribe	\$435.45
G	26-4056	Replacement Stylus Tip	\$42.95
H	26-4057	Foot Pedal	\$63.00



Foredom® Work Bench System

Create your own custom bench system with Foredom®. Combine the Foredom Flex Shaft Hanger with an innovative LED Light Bar and your choice of four different Tool Arms. This stainless steel system places everything within reach without cluttering your benchtop.

Everything is sold separately to allow a truly customizable experience. Purchase only what you need to make your bench a perfect place for you. The LED Light Bar swings up into a vertical position automatically turning off and getting out of your way when it isn't needed.

The four unique Tool Arms help to organize your bench in the best possible way. Choose from the Bur Holder Arm, Magnetic Tool Arm, Cup Holder Arm, and the Tray Arm to achieve a clean, clutter free work space.

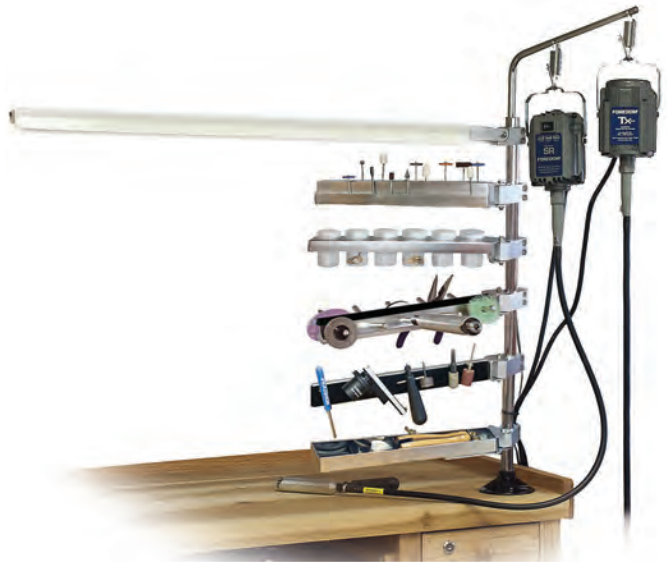

Flex Shafts

FOREDOM® WORK BENCH SYSTEM

17-3/4" tall Support Rod for holding pivoting LED light bar and swinging arms.

Item	Order #	Description	1+
A	34-1010	Support Rod 25 3/4"	\$42.00
	34-1010	Support Rod 17 3/4"	\$39.00
	34-1010	Motor Hanger with LED Light Bar	\$189.00
B	34-1010	Motor Hanger Only	\$59.00
C	34-1010	LED Light Bar	\$139.00
D	34-1010	Bur Holder Arm	\$69.00
E	34-1010	Cup Holder Arm	\$55.00
	34-1010	Peg Arm	\$69.00
F	34-1010	Magnetic Tool Arm	\$109.00
G	34-1010	Accessory Tray Arm	\$59.00
H	34-1010	Multi Handpiece Arm	\$75.00
J	34-1010	Dual Handpiece Rest	\$29.00

REPLACEMENT PARTS

	34-1012	Adapter Plug for light	\$39.00
	34-1012	Light Connector Cord Set	\$6.00
	34-1012	Light Shade	\$11.20
	34-1012	Micro Switch for light	\$1.50
	34-1012	LED Light Strip	\$59.00
	34-1012	Hanger Hook with Spring	\$4.80
K	34-1012	40ml Plastic Jars with Tops (Pack of 6)	\$8.00
	34-1012	4mm Head Hex Screw	\$0.50
L	34-1012	Base Mounting Plate	\$17.00
	34-1012	Light Shade	\$7.00

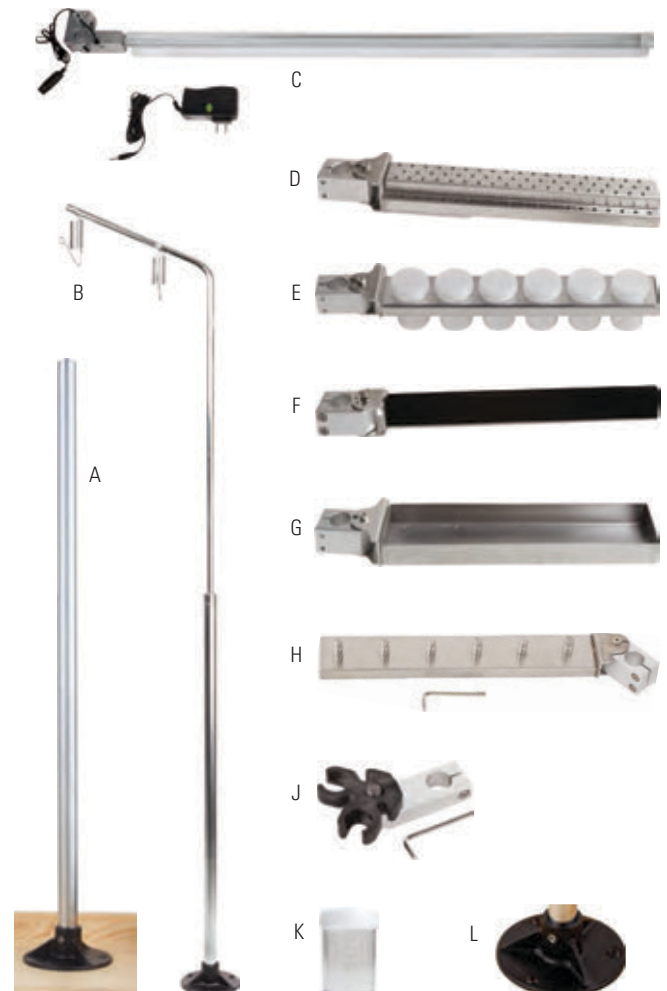

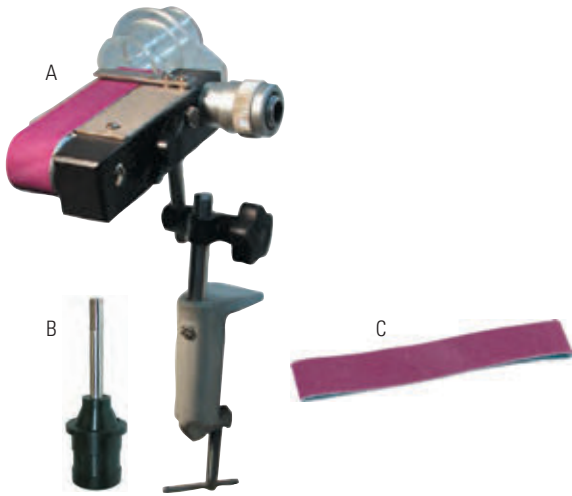

WOLF BELT SANDER SET

The Belt sander is convenient, compact, and connects to a flex shaft for power. It can be clamped directly on to the bench or mounted with an adaptor into a GRS® BenchMate™ for greater support. Included is an attachment for hooking up to a dust collection system, and five assorted Ruby belts.

Item	Order #	Description	Grit	1+
A	21-0491	Belt Sander with Assorted Ruby Belts		\$189.00
B	21-0492	GRS® BenchMate™ Adapter		\$16.85
C	21-0465	Ruby Belt	180	\$3.80
	21-0465	Ruby Belt	320	\$3.80
	21-0465	Ruby Belt	240	\$3.80
	21-0465	Ruby Belt	120	\$3.80
	21-0465	Ruby Belt	80	\$3.80

3M® REGAL XODUST 930DZ

These purple belts are coated with Cubitron™ ceramic aluminum-oxide mineral, simply the best you can get. When removal of material is required at a fast rate. Applications include sprue removal and casting clean-up. Good for all types of metal, wood, and plastics.

Item	Order #	Grit	W x L	12+	6+	1+
	21-0493	80	1" x 10½"	\$2.44	\$2.54	\$2.65
	21-0494	120	1" x 10½"	\$2.44	\$2.54	\$2.65
	21-0499	220	1" x 10½"	\$2.44	\$2.54	\$2.65
D	21-0501	Set of three (one of each)		\$5.60	\$6.30	\$7.00

A vacuum cleaner may be attached to the plastic tube to remove dust particles. To keep the pieces you are sanding from being sucked into the vacuum, put a piece of plastic screening, available from hardware stores, over the end of the tube, before attaching the hose. The optional GRS™ Adapter BE-100 (not included) fits into the GRS™ pivoting BenchMate™ collar (also not included). This allows for the easiest, infinite angle positioning—including upside down positioning—to work in between the rollers.

FOREDOM®



FOREDOM® ALLSET MASTER KIT

Used by professional setters, production stone setters, model makers, and designers. Both highly skilled and beginning stone setters will do their stone setting work faster and better—stone after stone. Improves stone setting quality because stones are set straighter, are level, held tighter, and less likely to break when channel or bezel setting are hammered.

Item	Order #	Description	1+
E	34-3000	Master Kit No. 30 Handpiece with DVD	\$449.00
F	34-3002	29-Minute How To DVD	\$5.50





FOREDOM®

FOREDOM® K.1070 MICROMOTOR KITS

Ideal for high-speed applications up to 38,000 RPM, including light deburring of cast pieces, bright cutting in jewelry making, and fine detailing.

A. K.1070 Rotary Kit Includes:

- Control-HP4
- Handpiece with 2.35mm (3/32") collet-MH-170
- Variable speed foot control-HP4-960
- Handpiece cradle-HP4-933
- Extra pair of motor brushes, spare fuses, collet changing wrenches

B. K.1020 High Torque Kit includes:

- 20,000 RPM max speed
- High torque, 60/50 Hz, 4.82 Amps DC
- Switch for either 110/120 or 220/240 voltage
- Dial control and foot control for variable speed
- Forward or reverse rotation
- Built-in overload protection
- CE compliant
- One-year Limited-Warranty

Kit Includes: Control Unit, Handpiece, Variable Speed Foot Control, Handpiece Cradle, Chuck key with handle, and extra set of motor brushes.

C. H.MH-120 features extra power and a geared three-jaw #0 chuck that takes any size rotary accessory or drill bit with shanks up to 5/32" (4mm) diameter. CE compliant. Comes supplied in Kit K.1020 and works with the same HP4-917 Control Unit that comes with Micromotor Kits K.1070, K.1080, and K.1090.



Item	Order #	Description	1+
A	34-6115	K.1070 Rotary Micromotor Kit	\$365.00
B	34-6114	K.1020 High Torque Kit	\$499.00
C	34-6113	High Torque Chuck Style Handpiece	\$338.00



FOREDOM® 1050 BRUSHLESS MICROMOTOR KIT

The 1050 Micromotor features high torque throughout the speed range of 1,000 to 50,000 RPM. High speed provides smooth, clean, and sharp detailing in metal. It's also great for bright cutting, grinding, finishing, texturing, and polishing. Low speed offers extra control and power for stone setting and milling.

Item	Order #	Description	1+
D	34-6116	MicroMotor Kit	\$899.00



SHEENUS NEO ULTRASONIC POLISHER

The NSK Sheenus Neo System can be used for grinding, polishing, removing burrs, and mirror-finishing on a wide range of materials from aluminum dies to cemented carbide dies. It is also perfect for plastic molds, precision molds, electronic dies, ceramic components, press, casting, forging, trimming, and header dies. This tool can quickly remove hard layers of EDM deposits and polishes difficult areas such as complex corners and ribs. Power source: 120V. Output: 45 watts.

Order #	Description	W x L x H	1+
35-1234	Ultrasonic Polisher	7 7/8" x 8 7/8" x 3 5/8"	\$2,754.00



Flex Shafts

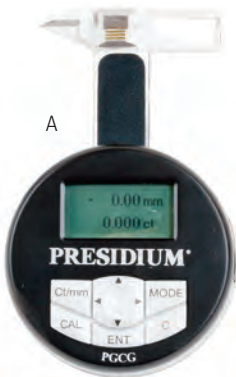

A

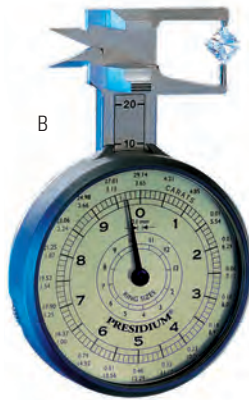

B

C



E



D



F

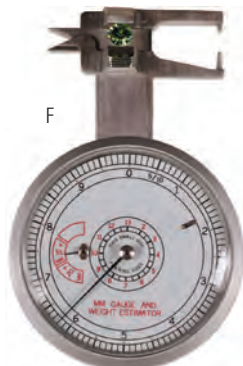

PRESIDIUM GEM COMPUTER GAUGE

Presidium Gem Computer Gauge estimates the weight and identifies gemstones with much greater precision and consistency.

- Covers 74 gemstones and nine different shapes
- Auto-magnetic shut-off to save power when placed in carrying case
- Direct carat conversion for round brilliant-cut diamond
- Hardened platform
- 0.01mm resolution
- Weight computation through direct measurement or keypad entry
- Universal serial bus interface with computer
- CD-Rom with 133 gemstones
- One-year manufacturer's warranty

Item	Order #	Description	12+	6+	1+
A	35-1815	Presidium Gem Computer Gauge	\$269.54	\$285.39	\$317.10

PRESIDIUM DIAL GAUGE

The Presidium dial gauge incorporates the latest technological design, construction, and features. Measurements are precise from 0 to 23mm with 0.1mm accuracy. Direct, carat-weight reading on dial. Accuracy maintained with wear-resistant, hardened anvils. Reduces hand fatigue because it is 20% lighter than other gauges. Manufactured with Swiss-made hardened steel and components. Comes with polishing cloth, weight estimation table, instructions, and accessory booklet.

Item	Order #	Description	12+	6+	1+
B	35-1812	Presidium Dial Gauge	\$127.50	\$135.00	\$150.00

PRESIDIUM DIGITAL GEMSTONE GAUGE

Electronic digital gemstone gauge. Uses battery CR2032. Features:

- Range 0 to 25mm
- Wedge-shaped points
- Slipper measuring platform
- Auto shut-off when placed in case
- Zero reset button
- Fixed rod

Item	Order #	Description	12+	6+	1+
C	35-1814	Digital Gemstone Gauge	\$228.65	\$242.10	\$269.00

DIGITAL STONE GAUGE

Ideal for calibrating stones. The simple design allows for any stone to be quickly and easily measured. Digital read-out with accuracy of 0.01mm. Simple on/off, millimeter/inch, and zero set functions. One-year factory warranty.

Item	Order #	Description	12+	6+	1+
D	35-1203	Right-Handed Digital Gauge	\$56.19	\$59.49	\$66.10

DIGITAL GAUGE

Three button gauge measures three decimal places in millimeters or inches. Zeros at any setting. Made of high-impact plastic, and measuring tips are stainless steel. Auto shut-off. Case included. 0-20mm, .01 accuracy.

Item	Order #	Description	12+	6+	1+
E	35-1817	Digital Gauge	\$65.88	\$69.75	\$77.50

ANALOGUE GAUGE

For those who prefer an analogue gauge, this one measures 0-23mm with 0.1mm accuracy. Made of stainless steel for rugged use and three-way measurements. Case included. B&S thickness conversion table on the back.

Item	Order #	Description	12+	6+	1+
F	35-1813	Analogue Gauge	\$92.78	\$98.24	\$109.15

GEMLOGIS DIGITAL SORTING GAUGE

The Gemlogis SAFFRON provides direct digital readout as you pick up loose stones with ease. It is the most convenient way for sorting gemstones of various sizes. No need to hold a tweezer in one hand and a gauge in the other, .02 accuracy.

Item	Order #	Description	1+
A	35-1202	Gemlogis Digital Sorting Gauge	\$101.95



CARBON FIBER DIGITAL THICKNESS GAUGE

This digital thickness gauge is lightweight and easy to use. It features a large, easy to read LCD display and its carbon fiber composite construction makes it both lightweight and durable.

- 8 mm LCD display
- Measuring range: 0-12 mm
- Resolution: 0.01 mm

Item	Order #	Description	1+
B	35-5628	Carbon Fiber Digital Thickness Gauge	\$10.35



DIGITAL THICKNESS GAUGE

Special functions include inch/millimeter conversion and zero-set at any point.

- Measuring range: 0-12.7mm
- Resolution: 0.01mm/0.0005"

Item	Order #	Description	1+
C	35-5629	Digital Thickness Gauge	\$15.55



COMPACT DIGITAL GAUGE

Compact digital gauge measures from 0 to 25mm and 0 to 1". Millimeter accurate to two decimal points and inch fractions to three decimal points. Stainless steel with high-impact plastic housing. Inside and outside measurements. Comes with protective case.

Item	Order #	Description	1+
D	35-1818	Compact Digital Gauge	\$68.00



DIAL THICKNESS GAUGE

Ideal for measuring pearls and other stones up to 10mm.

Specifications: 0-10mm x 0.01mm.

Item	Order #	Description	1+
E	35-2301	Dial Thickness Pearl Gauge	\$29.00



MILLIMETER GAUGE

Excellent for measuring pearls and stones of all kinds. Smooth action assures accuracy. Gauge is made to zero out when closed, and open automatically. This assures a gentle force when measuring soft stones and pearls. Dial features "zero adjust" and is accurate to 0.1mm. Maximum opening width is 20mm. Made in Germany.

Item	Order #	Description	1+
F	35-1200	Millimeter Pearl Gauge	\$33.00

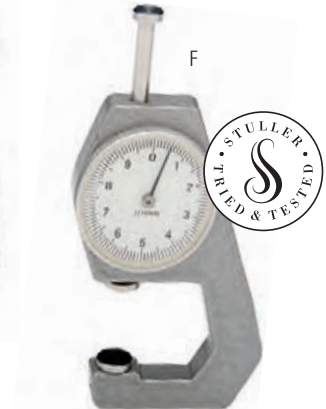



A



ELECTRONIC DIGITAL CALIPER

Stainless steel, instant readout digital caliper. Measures inside, outside, and depth. Accurate to 0.0005" (0.01mm). Measuring range from 0 to 6" (0 to 100mm). Includes protective case and battery EBAT357.

Item	Order #	Description	Length	1+
A	35-1797	100mm Digital Caliper	4"	\$26.50



B



DIGITAL CALIPER

Electronic Digital Caliper with large LCD readout. Measures ID and OD from 0.0005" (0.01mm). Depth measures from 0 to 150mm. Takes a SR44 (EBAT357) battery.

Item	Order #	Description	Length	1+
B	35-1798	150mm Digital Caliper	6"	\$32.00

C



DIAL CALIPER

Stainless steel dial caliper measures inside, outside, and depth. Accurate to 0.02mm. Measuring range from 0 to 150mm. Easy to read "adjust to zero" dial and thumb roller with lock. Maximum opening 6".

Item	Order #	Description	Length	1+
C	35-1830	150mm Dial Caliper	9"	\$23.70

D



STAINLESS STEEL VERNIER CALIPER

Precision gauge measures in metric and inches up to 150mm to (0.02"). Four-way use with roll wheel.

Item	Order #	Description	Length	1+
D	35-1796	150mm Stainless Steel Caliper	6"	\$35.00

E



F

G



H

BRASS SLIDING GAUGES

Each gauge is a combination of millimeter and inches. Available in standard, pointed, or notched. (Notched jaw measures inside or out.) Made in Germany.

Item	Order #	Description	Length	12+	6+	1+
E	35-1522	Standard	3/4"	\$11.18	\$11.84	\$13.15
F	35-1520	Standard	2/4"	\$10.29	\$10.89	\$12.10
G	35-1524	Notched	2/4"	\$10.29	\$10.89	\$12.10
H	35-1526	Pointed	2/4"	\$12.07	\$12.78	\$14.20



J



K



GAUGE DELUXE

Metal underplate holds small stones and parts in place to allow fast and accurate measurements. Also works great for normal measurements. Plate is non-removable.

Item	Order #	Description	Length	12+	6+	1+
J	35-1529	Beadalon Gauge	2 1/2"	\$7.01	\$7.43	\$8.25
K	35-1528	Stone Gauge	3/4"	\$8.46	\$8.96	\$9.95

PRECISION WIRE AND SHEET GAUGE

American standard wire and sheet gauge used for measuring wire and sheet metals from 0 to 36 gauge. Chrome-finished, heavy-gauge, hardened and tempered tool steel. Decimal equivalents of each size are stamped on reverse side. Measures $\frac{3}{4}$ " diameter and $\frac{3}{32}$ " thick.

Order #	Description	12+	6+	1+
35-5609	Wire/Sheet Gauge	\$21.68	\$22.95	\$25.50



Front



Back

STAINLESS STEEL FLEXIBLE RULER

Overall length 6" and width $\frac{1}{2}$ ". Top is graduated in millimeters and $\frac{1}{32}$ " increments across the lower half. All graduations are deeply etched.

Order #	Width	Length	12+	6+	1+
35-5100	$\frac{1}{2}$ "	6"	\$1.79	\$1.89	\$2.10

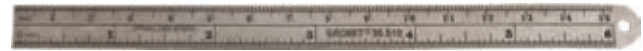
**JEWELRY MAKER'S SCALE**

Covers all the jeweler's ring shank, bracelet, and sheet measuring needs. Stainless steel with etched graduations for permanent visibility. Six-inch scale graduated in $\frac{1}{16}$ ", 150mm scale graduated in millimeters. Shows metal length required for bracelet to fit any wrist size.

Order #	Length	12+	6+	1+
35-5115	6"	\$5.61	\$5.94	\$6.60

**MULTI USE RULER GAUGE**

This pocket tool performs several separate and distinct functions. The bevel protractor is used for measuring and laying out angles. The center finder locates centers of circles. The circle divider is used for dividing circles into sectors. Made of stainless steel, the ruler has etched graduations in inches and millimeters.

Order #	Length	12+	6+	1+
35-5104	4"	\$9.35	\$9.90	\$11.00

**STAINLESS STEEL PROTRACTOR**

Set levels, and measure and transfer angles with this stainless steel protractor. Made of ground stainless steel for optimum accuracy. Permanently etched graduations from 0 to 180° in opposite directions. Six-inch adjustable protractor locks into position with knurled thumb nut and $3\frac{3}{8}$ " x 2" head.

Order #	Description	12+	6+	1+
35-5106	Adjustable Protractor	\$13.09	\$13.86	\$15.40

**MARK-A-SIZE**

Used to scribe cutting lines accurately when reducing ring sizes. Consists of 12 sizes that are graduated in quarter ring sizes from $\frac{1}{4}$ " to 3". Made of hardened steel with sharp edges. Folds when not in use.

Order #	Description	12+	6+	1+
35-0705	Mark-A-Size	\$38.08	\$40.32	\$44.80





COMBINATION DEGREE GAUGE

Lightweight and made of polished steel with easy-to-read brass indices. Adjustable point for close tolerance work. Three-quarter inch jaw. Capacity 72 lignes and 120mm.

Order #	Description	12+	6+	1+
35-0140	Combination Degree Gauge	\$38.46	\$40.73	\$45.25



KERR® CALIPER

Stainless steel and calibrated in 0.1mm. Excellent for measuring wall thicknesses. Rounded tip caliper is perfect for wax carving. The pointed tip is perfect for metal work.

Order #	Description	12+	6+	1+
21-0025	Round Tip Caliper	\$31.88	\$33.75	\$37.50



JO-DI DIAMOND WEIGHT GAUGE

Used to estimate carat weights for four basic diamond shapes (round, marquise, emerald, and pear) without removing stones from mounting. Measure depth and width with caliper and then compare with tables in the 70-page reference booklet provided. Instructions in four languages: English, French, Spanish, and German. Sold with wallet. Made of metal. One side measures in millimeters and the other in carats.

Order #	Description	12+	6+	1+
35-5510	Diamond Weight Gauge	\$33.96	\$35.96	\$39.95

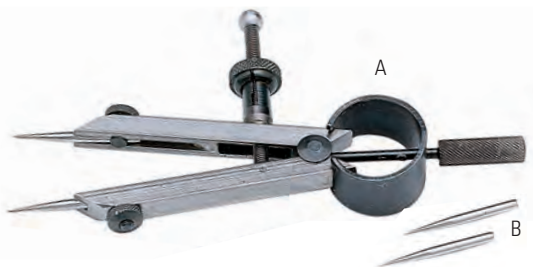

SPRING DIVIDER WITH ADJUSTABLE POINTS

Sharp, pointed tips are adjustable and can be replaced. Maximum opening 2¾" with tips retracted or 3¼" with tips extended. Special quick-adjustment nut and heavy-duty spring. Made in Germany.

Item	Order #	Description	Length	12+	6+	1+
A	35-0805	Spring Divider	2½"	\$12.20	\$12.92	\$14.35
B	35-0806	Replacement Tips (sold per pair)		\$2.25	\$2.38	\$2.65



STARRET DIVIDER

Highly-polished dividers made of spring steel with hardened, tempered, and well-balanced round legs. Floating washer and thumb screw permit fast and positive adjustment.

Order #	Description	Length	12+	6+	1+
21-1128	Divider with 3 inch legs	3"	\$63.75	\$67.50	\$75.00



SPRING DIVIDER

Features heavy-duty, spring action with a special, quick-adjustment nut. The perfect tool for measuring distances between points and scribing circles and arcs. Made in Germany.

Order #	Max Opening	Leg Length	12+	6+	1+
35-0800	2¼"	3"	\$12.20	\$12.92	\$14.35
35-0802	6½"	6"	\$13.18	\$13.95	\$15.50

DEGREE GAUGE

Light weight and made of coated steel with and easy-to-read brass indices. Adjustable point for close tolerance work.

Order #	Description	12+	6+	1+
35-0200	0-10 mm Degree Gauge	\$13.56	\$14.36	\$15.95
35-0300	0-15 mm Degree Gauge	\$14.41	\$15.26	\$16.95



DIAMOND SIEVES

Used for sorting stones, beads, and pearls according to size. Complete set of 21 plates fit in zippered carrying case. Chart indicates plate size of stones per carat, weight, and millimeter size.

Item	Order #	Description	12+	6+	1+
A	51-0560	1 7/8 in. (1.1mm-4.5mm)	\$59.46	\$62.96	\$69.95
B	51-0565	2 5/8 in. (0.74mm-4.45mm)	\$108.12	\$114.48	\$127.20

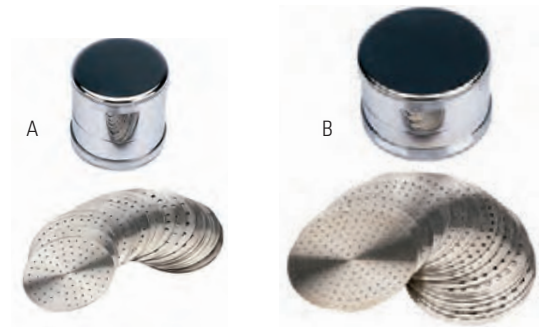

SIEVE HOLDER BOX

Plastic holder box for stone sieves. Designed to hold 42 sieves.

Order #	W x L x H	12+	6+	1+
51-0569	12" x 4 1/2" x 4 1/2"	\$25.08	\$26.55	\$29.50



Sieves not included

MELEEMETER™ MICROGAUGE SYSTEM

Meleemeter™ microgauge system consists of 10 business-sized-card templates encased in a solid brass carrying case for safe keeping. These templates will eliminate the need for measuring and computing melee weights with 590 melee shapes and sizes placed around the edges, giving maximum access to mounted melee. Contains gauge for trillion diamonds including weight formulas.

Order #	Description	12+	6+	1+
35-5617	MicroGauge System	\$46.71	\$49.46	\$54.95



MEASUREMATE® REFERENCE CARD SET

Plastic reference cards for quick and simple jewelry related information. A great tool for the retail counter salesperson or bench jeweler. The cards contain information ranging from identifying birthstones to identifying diamond shapes to anniversary gifts. Cards come in protective sleeves. Black illustrations for easy reading in vinyl wallet.

Order #	Description	12+	6+	1+
35-5615	10-Piece Card Set	\$10.20	\$10.80	\$12.00

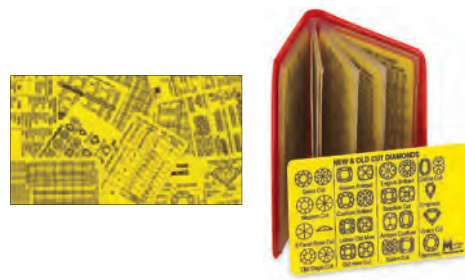



DIAMOND SELLER

Used to show sizes of brilliant-cut diamonds. Cubic zirconias are mounted on stainless steel arms. Each arm is marked with size and carat weight. Shows 10 sizes from 0.1 to 2 carats. Folds within a protective cover when not in use.

Order #	Description	12+	6+	1+
35-5550	Stainless Steel Diamond Seller	\$50.62	\$53.60	\$59.55



K&B DIAMOND AND STONE GAUGE

Pocket gauge used for measuring loose stones and settings ranging from three points to four carats. Made of aluminum. Reverse side is embossed with birthstone chart.

Order #	Description	12+	6+	1+
35-5602	Aluminum Diamond and Stone Gauge	\$6.67	\$7.07	\$7.85



DIAMOND OR GEMSTONE FAN GAUGE

Pocket stainless steel gauge for measuring brilliant-cut, marquise, pear, square, emerald, and oval-cut stones. Measures 3½" closed. Stone measurements are in carat weights. Made in the USA. Seven blades.

Order #	Description	Width	12+	6+	1+
35-5610	Diamond/Gem Fan Gauge	3½"	\$15.56	\$16.47	\$18.30



STONE AND MOUNTING GAUGE

Aluminum gauge with holes used to measure stones, and the extensions are used to measure mountings. One side indicates millimeters; the other side indicates the corresponding carat measurement.

Order #	Description	Sizes	12+	6+	1+
35-5515	Stone and Mounting Gauge	2-11mm	\$12.16	\$12.87	\$14.30



DIAMOND GAUGE

Measures round and baguette stones from 1/1000 to 2 carats. Made of aluminum. Folds to 1½" in diameter.

Order #	Description	Width	12+	6+	1+
35-5600	Diamond Gauge	1½"	\$6.33	\$6.71	\$7.45



PREMIUM BRACELET GAUGE

Quality bracelet size gauge for fitting bracelets. Adjustable band with sizes marked from 5" to 9" in ¼" increments. Made of high-grade steel. Imported from France.

Order #	Description	Gauge Increments	12+	6+	1+
35-2612	Bracelet Gauge	¼"	\$17.00	\$18.00	\$20.00

BANGLE/BRACELET GAUGE

Three sizes of bracelet gauges. All are heavy gauge base metal, nickel-plated, and securely attached to a handy 2¾" ring.

Order #	Description	Ring Sizes	12+	6+	1+
35-2605	Small	1-9mm	\$9.35	\$9.90	\$11.00
35-2606	Medium	10-18mm	\$9.35	\$9.90	\$11.00
35-2607	Large	19-27mm	\$9.35	\$9.90	\$11.00



SHANK SIZE AND BRACELET GAUGE

Used for measuring wire or flat stock for proper size ring and bracelet shanks. Includes guide to various shapes and sizes of metal. Ring sizes from 1 to 14; bracelets from baby's to large men's sizes.

Order #	Description	Ring Sizes	12+	6+	1+
35-0425	Shank and Bracelet Gauge	6-26mm	\$3.49	\$3.69	\$4.10

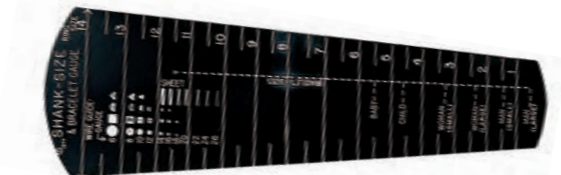

HANDY SIZER RING GAUGE

New, thin flat ring sizer that fits in your pocket. Customers can inconspicuously take it home to measure a ring. Has a handy millimeter gauge on the end.

Order #	Description	Sizes	12+	6+	1+
35-5117	Plastic Gauge	1.5-12mm	\$4.25	\$4.50	\$5.00



MULTI FINGER SIZER

Customers can easily and confidentially measure their own finger sizes from 0-17 with accurate full, half, and quarter sizes. The low price of this multi sizer means you can give them away when a customer wants to buy that surprise ring for a special gift. Multi sizers come in individual envelopes with instructions.

Order #	Description	Ring Sizes	12+	6+	1+
35-2610	Multi-Sizer	1-17mm	\$0.43	\$0.45	\$0.50



PLASTIC FINGER GAUGE

The perfect complement to your standard ring sizer. Give your customer a perfect fit every time. Available in quarter sizes and a combination of full and half sizes. With easy-to-read rings on a metal chain and disposable rings on a sheet. U.S. standard sizes.

Item Order #	Description	Ring Sizes	12+	6+	1+
A 35-2625	Quarter Sizes (no half sizes)	4.25-13.25mm	\$3.74	\$3.96	\$4.40
B 35-2650	Full and Half Sizes	4-12mm	\$1.49	\$1.58	\$1.75
C 35-2626	Disposable Sheet	2.5-14mm	\$0.43	\$0.45	\$0.50

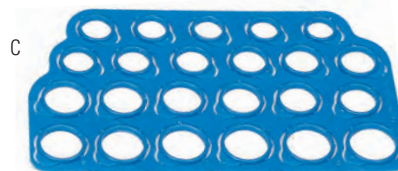
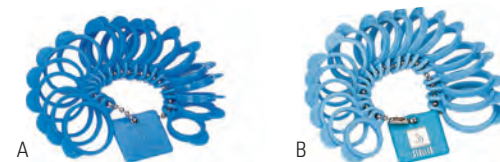

ACCUSIZER

Sturdy, lightweight plastic that open and close identical Superfit® shanks.

Order #	Description	Ring Sizes	12+	6+	1+
35-2614	Accusizer Ring Sizer	2-11.5mm	\$7.48	\$7.92	\$8.80



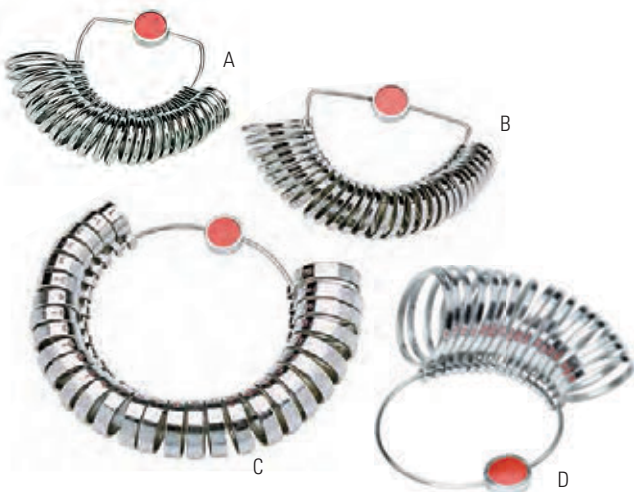

FINGER GAUGE

Nickel-plated finger gauges graduated in U.S. standard half-sizes.

Item	Order #	Description	Ring Sizes	Increments	12+	6+	1+
A	35-2613	3mm/Half-Round	1-15	1/2"	\$12.75	\$13.50	\$15.00
B	35-2615	2.8mm/Flat	1-15	1/2"	\$15.47	\$16.38	\$18.20
C	35-2620	6mm/Flat	1-15	1/2"	\$14.03	\$14.85	\$16.50
D	35-2622	3.9mm/Flat	16-24	1/2"	\$8.67	\$9.18	\$10.20
E	48-7525	4mm/Comfort-Fit	1-15	1/2"	\$14.03	\$14.85	\$16.50
F	35-2611	2.8mm/Flat	1.25-12.75	1/4"	\$14.03	\$14.85	\$16.50
G	35-2621	6.8mm/Half Round	1-15	1/2"	\$17.77	\$18.81	\$20.90
H	48-7526	7mm/Comfort-Fit	1-15	1/2"	\$14.96	\$15.84	\$17.60



PRECISION RING GAUGES

J. Die-struck finger gauges are made to be an exact match to the graduated steel mandrels below.

PRECISION STEEL MANDRELS

K-L. Graduated or grooved. U.S. standard sizes.

Item	Order #	Description	Ring Sizes	Increments	12+	6+	1+
J	38-2618	Flat	1-16	1/2"	\$12.16	\$12.87	\$14.30
K	35-2801	Graduated/Grooved	1-16	1/2"	\$22.95	\$24.30	\$27.00
L	35-2802	Graduated	1-16	1/2"	\$23.84	\$25.25	\$28.05
	35-2803	Gauge and Mandrel (35-2801) Set			\$27.16	\$28.76	\$31.95



WOODEN RING MANDREL

Ring stick made of finely finished hardwood, excellent for glass counters and wire work. Will not mar or scratch the ring while hammering or shaping.

Item	Order #	Description	Ring Sizes	Length	12+	6+	1+
M	35-2947	Non-Roll Hex Handle	3-15	12 1/2"	\$11.90	\$12.60	\$14.00
N	35-2945	Shaping		11 1/2"	\$5.61	\$5.94	\$6.60



HOLLOW RING MANDRELS

Hollow, metal ring stick. Has gauge for material length needed to make specific size rings. Nickel-plated with wood handle. Graduated in U.S. standard quarter sizes.

Item	Order #	Description	Ring Sizes	12+	6+	1+
A	35-2840	Grooved	1-15	\$22.82	\$24.17	\$26.85
B	35-2860	Non-Grooved	1-15	\$17.98	\$19.04	\$21.15

**PLASTIC RING STICK**

Plastic ring stick. Graduated in U.S. standard quarter sizes.

Item	Order #	Description	Ring Sizes	12+	6+	1+
C	35-2880	Grooved	1-15	\$4.42	\$4.68	\$5.20

**ALUMINUM RING MANDRELS**

Solid, aluminum ring stick. Graduated in U.S. standard quarter sizes.

Item	Order #	Description	Ring Sizes	12+	6+	1+
D	35-2800	Grooved	1-13	\$18.70	\$19.80	\$22.00
E	35-2820	Non-Grooved	1-13	\$18.23	\$19.31	\$21.45

**ALUMINUM RING MANDRELS**

Solid, aluminum and gold anodized ring stick. Graduated in U.S. standard quarter sizes.

Item	Order #	Description	Ring Sizes	12+	6+	1+
F	35-2999	Grooved	1-16	\$26.52	\$28.08	\$31.20
G	35-2998	Non-Grooved	1-16	\$26.52	\$28.08	\$31.20

**STEEL STEPPED RING MANDRELS**

Avoid distortion caused by tapered mandrels on wide shank rings. Marked graduated sizes.

Item	Order #	Ring Sizes	Increments	Length	12+	6+	1+
H	35-2902	4-16mm	Whole	13½"	\$29.96	\$31.73	\$35.25
J	35-2903	3.5-15.5mm	Half	13½"	\$29.96	\$31.73	\$35.25

**STEEL RING MANDRELS**

Item	Order #	Description	Ring Sizes	Length	12+	6+	1+
K	35-2914	Grooved	1-12	12"	\$28.09	\$29.75	\$33.05
L	35-2912	Non-Grooved	1-12	12"	\$28.09	\$29.75	\$33.05

**DURSTON RING MANDRELS**

Durston's new high quality forming and tapered ring mandrels. Hardened to 64 RC. Two sizes available: 10mm-25mm and 10mm-28mm.

Item	Order #	Description	Ring Sizes	Length	12+	6+	1+
M	35-2915	Non-Grooved	10-28	16"	\$33.74	\$35.73	\$39.70
N	35-2915	Grooved	10-25	14½"	\$30.94	\$32.76	\$36.40





STEEL RING MANDRELS

Larger ring mandrel.

Item	Order #	Shape/Style	Ring Sizes	Length	1+
A	35-2910	Round, Grooved	1-16	13½"	\$31.95
B	35-2900	Round, Ungrooved	1-16	13½"	\$31.95



STEEL RING MANDRELS

Larger mandrel for large rings, hoop earrings, and coin holders. Graduated solid steel mandrels in U.S. standard quarter sizes. Can be used for soldering. Made in the USA.

Item	Order #	Shape	Ring Sizes	Length	1+
C	35-2918	Round	16-24	8¼"	\$31.50



STEEL RING MANDRELS

Flat-sided ring mandrel. Used for forming, straightening, or enlarging bezel-set rings. Can also be used in place of a grooved mandrel.

Item	Order #	Shape	Ring Sizes	Length	1+
D	35-2916	Half Round	1-16	13½"	\$33.05



STEEL SPECIALTY MANDRELS

Unmarked mandrels.

Item	Order #	Shape	Ring Sizes	Length	1+
E	35-2909	Octagon	6.8-23.7	13½"	\$41.85



STEEL SPECIAL SHAPED MANDRELS

Square Mandrel—"Rounded square"—similar to square mandrel except it has rounded corners. Has natural shape of finger and comfortable fit. Unmarked. Rounded Modified Square Mandrel. Unmarked forming mandrel. Graduated from 6.5mm to 17.7mm.

Item	Order #	Shape	Ring Sizes	Length	1+
F	35-2905	Round, Square	6.5-17.7	13½"	\$35.25
G	35-2904	Round, Square	6.5-17.7	13½"	\$35.25



MICRO-MANDRELS

H. This micro-round mandrel is ideal for making jump rings and other small findings. The hardened steel is precision ground and 160mm in length. Made in Switzerland.



J. This small, round mandrel is suited to fabricating and forming jump rings, small bezels, and rings. The hardened steel is precision ground and 220mm in length. Made in Italy.



K. This small, oval mandrel is suited to fabricating and forming jump rings, small bezels, and rings. The hardened steel is precision ground and 220mm in length. Made in Italy.



L. This small, square mandrel with sharp edges is used for making joints and bezels. The hardened steel is precision ground and 220mm in length. Made in Italy.

Item	Order #	Shape	Tapers To (mm)	Length	1+
H	35-2980	Round	1.5-5	6¼"	\$36.40
J	35-2981	Round	3-10	8½"	\$32.00
K	35-2982	Oval	3-10	8½"	\$42.85
L	35-2983	Square	4-10	9"	\$38.50

The wood presentation box also has a sizing conversion chart.



TRUE-SIZE SIZING SYSTEM

The True-Size ring sizing system has 47 precise, comfort fit, 6mm wide bands. The sizes include 1-16 which are in half sizes and the most popular sizes (4-12) come in quarter sizes also. The sizes are laser etched on a facet on the outside of each ring. The wood presentation box also has a sizing conversion chart.



Order #	Description	1+
35-1094	Ring Sizing System	\$195.00

STEEL BEZEL MANDRELS

Bezel mandrels are case hardened, high polished, and precision ground. 11" long. Made in the USA.

Item	Order #	Shape	Ring Sizes	Length	1+
A	35-2922	Square	2.5-8.9	11"	\$28.65
B	35-2929	Triangle	2.5-9.7	11"	\$28.65
C	35-2923	Rectangle	1.5x3.6-7.8x10.1	11"	\$28.65
D	35-2921	Oval	2.8x3.6-11.4x2.4	11"	\$26.45
E	35-2924	Teardrop	2.8x4.1-11.4x11.9	11"	\$28.65
F	35-2920	Round	3.8-12.4	11"	\$26.45
G	35-2930	Teardrop	9.5x11.3-17.9x20.3	11"	\$28.65





NECKLACE MANDREL

Polished cast iron shapes necklaces perfectly and easily. Work metals or use this mandrel to form wax. Made in Italy.

Order #	Description	W x L x H	12+	6+	1+
35-2964	Necklace Mandrel	8½" x 7¾" x 7"	\$105.70	\$111.92	\$124.35



ROUND HOOP MANDREL

Hard chrome-plated steel with a highly polished surface and tapers for a wide range of rings, earrings, hoops, and bracelets. The mandrel gives a great variety of uses for goldsmiths, silversmiths, jewelers, and bead artists.

Order #	Shape	Ring Sizes	Length	1+
35-2810	Round	¾"-2"	12"	\$29.70



ROUND WOOD BRACELET MANDRELS

Made of wood to help prevent marring and scratching when shaping and forming bracelets and other round items.

Item	Order #	Description	Tapers To	12+	6+	1+
A	35-2940	Small	¾"-2"	\$12.16	\$12.87	\$14.30
B	35-2941	Medium	1½"-2½"	\$14.96	\$15.84	\$17.60
C	35-2942	Large	2"-3½"	\$15.90	\$16.83	\$18.70



TAPERED BRACELET MANDRELS

Hollow cone, case-hardened mandrels. Used for shaping, stretching, and forming bracelets and other items. Made in India.

Item	Order #	Shape	Tapers To	Length	1+
D	43-0500	Oval	1⅜" x 1⅞" - 3" x 3½"	15"	\$39.65
E	43-0540	Round	1¾" - 3½"	15"	\$39.65



DURSTON RING MANDRELS

This high-quality, hardened, and polished steel mandrel is ideal for shaping and forming bracelets. Offered in two shapes of round and oval.

Item	Order #	Description	Length	1+
F	43-0501	Round	15"	\$119.60
F	43-0502	Oval	15"	\$131.05

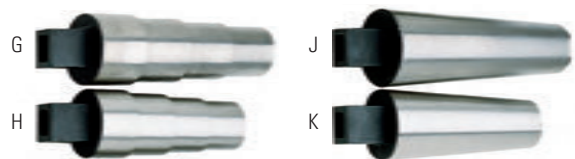

BRACELET MANDRELS

Constructed of cast iron. Used for shaping and stretching bracelets and large ovals in a vise or a workbench. Each tang is 1¼". Made in the USA.

Stepped Mandrels Stepped mandrels have four steps each.

Tapered Mandrels Smooth taper.

Item	Order #	Shape/Style	Tapers To	1+
G	35-2925	Round, Stepped	2", 2¼", 2½", 2¾" - 2½x2¾"	\$54.00
H	35-2926	Oval, Stepped	1¾", 2⅞", 2½", 2¾" - 2½x2¾"	\$54.00
J	35-2927	Round, Tapered	3" - 2"	\$50.70
K	35-2928	Oval, Tapered	1¾" x 2⅞" - 2½" x 2¾"	\$50.70

IMAGEDOME MICRO

A new way to capture jewelry, bringing any area into view for you and your customer. Not just for close up work, it is designed to be your one-stop imaging platform. Traditional light boxes deliver a good image for general use, but the design limits the ability to capture the multiple angles needed for detailed inspection. A flat stage attachment allows you to lay out flat pieces and a surprisingly large field of view to accommodate neckwear and other large items. As with all equipment made for taking pictures of jewelry, lighting is critical. Easy-to-use but extremely flexible lighting system. LED lamps on each side aim at movable side panels to create indirect lighting and adjustable hotspots and reflection areas. Diffused light is delivered from a light ring around the camera. The on-board LED lights housed in the camera are diffused as well and can even be turned off from the control software. Kit includes Image Dome and Dino-Lite Camera, a ring holder, two stone holders, and a diffuser for the camera lights.



Find added video content on Stuller.com.

Order #	Description	1+
29-1511	Image Box and Microscope Camera Kit	\$1,595.00
29-1510	Image Micro Light Box	\$1,295.00
29-1512	Accessory Kit	\$179.00

PHOTOGRAPHY BOX

Designed for use with consumer-oriented digital cameras, this photo box puts the camera control in your hands. A single switch controls the two fluorescent 5500°K lights in the bottom and back. Bright white interior side panels and door provide the perfect reflective surfaces to complement the diffused lighting. Magnetically hinged door can easily be opened and removed. Creates a shadow-free, wraparound lighting environment ideal for jewelry photography.

- Sturdy construction and compact size for portability
- Reflective lighting - Flexible camera angles - No Software



Order #	Description	W x L x H	1+
13-2030	Mini Photo Box	10" x 8" x 8"	\$269.00
13-2031	Small Photo Box	12" x 9" x 9"	\$295.00
13-2032	Medium Photo Box	14" x 12" x 11"	\$495.00
13-2033	Large Photo Box	16" x 14" x 13"	\$595.00

DINOLITE MICROSCOPE

This handheld digital microscope/camera is easy to use and comes with a USB output interface or AV/TV output interface. High-resolution magnification is at your fingertips with detailed examination of any area you choose. Additional accurate measurement (not available on Mac OS) allows detailed analysis and documentation of the captured images. Both cameras also have eight LEDs with an on/off feature for illumination, as well as glare reduction. Included with each Dino-Lite digital microscope is a copy of the DinoCapture software, enabling you to capture either a photograph, video, or time-lapse video with a simple click. Computer not included.

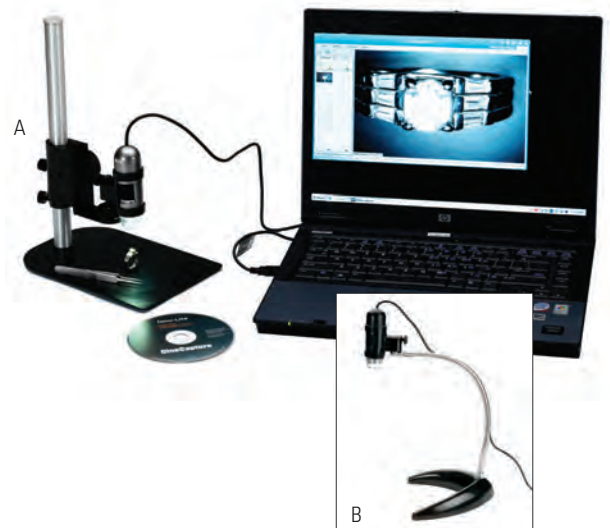

Item	Order #	Description	1+
A	29-1501	Digital Microscope/Camera and Tabletop Stand	\$499.00
B	29-1506	Digital Microscope/Camera and Flexible Stand	\$438.00
	29-1502	Digital Microscope/Camera (USB)	\$399.00
	29-1503	Digital Microscope/Camera (TV)	\$299.00
	29-1504	Tabletop Stand Only	\$99.00
	29-1505	Flexible Desktop Stand Only	\$39.00



GIA® MICROSCOPE

- Electrically noise-free lighting environment
- GIA® patented Darkfield and Brightfield Illumination
- Digital intensity control dark field
- Stable illumination, void of spikes, flickers, or yellowish color changes
- Two strategically designed illumination ports under the stage
- Digital 100-240 voltage auto switching

Internal Optics

- GIA® designed
- Finest German lenses milled to GIA® specifications
- Stereo dual diopter power zoom magnification 10X to 64X

Ergonomic Base

- Clear digital lighting substantially reduces eye fatigue
- Swivel base with patented stationary power cord eliminates cord tangles
- Wider work stage for optimum hand comfort
- Ergonomically designed adjustable base promotes proper posture for viewing

Includes Accessories

- Wire stone holder
- Dust cover
- GIA® HighView™
- Eye guards
- User guide

Item	Order #	Description	1+
A	29-1602	GIA® Research Series Microscope with LCD Readout	\$4,195.00
ACCESSORIES			
B	61-1743	Wire Stone Holder	\$85.00
C	61-1742	Inclusion Pointer	\$95.00
D	61-1741	Color Grading Disc	\$79.35
E	61-1740	Diffuser Plate	\$199.95
F	29-1652	Overhead Light Source	\$495.00
G	29-4855	Refractive Index Liquid (10 grams)	\$94.65
H	29-4848	Duplex Refractometer (includes RI Liquid)	\$925.00



GIA® ILLUMINATOR POLARISCOPE

The fastest way to test gemstones' optical properties. Quickly determine whether translucent or transparent gems are singularly or doubly refractive. Resolve optic character in doubly refractive gems, spot pleochroism, and detect diamond strain. Opening at front can double as light source. Includes interference figure sphere. Optional stone holder, mounts on both sides. Operates on 110V and 220V with a user changeable bulb.

Item	Order #	Description	1+
J	29-4840	Illuminator Polariscopes	\$395.00
K	29-4841	110V Replacement Bulb	\$11.50
L	29-4842	Replacement Interference Figure Sphere	\$17.25

GEMORO® ELITE MODEL 1067 SIGNATURE SERIES MICROSCOPE

- Precision 10X - 67X zoom with Japanese quality optics
- Offering the world's first LED darkfield/brightfield
- Rheostat controlled intensity LED darkfield/brightfield illumination with adjustable iris diaphragm and sliding baffle
- LED goose neck with interchangeable intense-beam UV/LED illumination
- Tilt with 55°
- Microscope head and base swivel 360°
- Includes a briefcase style metal carrying case, eye guards, Full view gem clip, dust cover, and more
- Internationally adaptable 100V-240V powered
- Five-year mechanical warranty
- Two-year electrical warranty



Item Order #	Description	1+
A 29-4749	Elite 1067 Series Microscope	\$2,395.00

GEMORO® ELITE MODEL 1067ZX

- 10X - 67X zoom microscope with built-in additional overhead light source
- Superior Japanese quality optics
- True professional darkfield / brightfield illumination with a sliding baffle
- Adjustable iris diaphragm controls the width of the lower light
- 360° rotating head for convenience
- Includes Full view gem clip stone holder, eye guards and dust cover
- Features a 5-year mechanical warranty and a 2-year electrical warranty



Item Order #	Description	1+
B 29-4755	Elite 1067ZX Series Microscope	\$829.00

GEM SCOPE ELITE 1030 MICROSCOPE

- Superior Japanese quality optics
- 10X-30X magnification
- New European design, single-cast body
- True professional tungsten-halogen darkfield/brightfield illumination with sliding baffle
- Adjustable iris diaphragm controls width of the lower light
- Full-view gem clip
- 360° rotating head
- Comfort eye guards
- Dust cover
- Five-year mechanical warranty
- Two-year electrical warranty



Item Order #	Description	1+
C 29-4740	Elite 1030 Microscope	\$259.00
D 29-4741	Replacement Bulb, 12V/110W	\$5.00
E 29-4744	Replacement Stone Clip (fits models 1030 and 745)	\$52.95



GEM SCOPE ELITE 745 ZOOM MICROSCOPE

- Superior Japanese Quality optics
- 7X-45X zoom magnification, zoom stays in focus through all magnifications
- European design, single-cast body
- True professional Darkfield/Brightfield illumination with "Sliding Baffle"
- Adjustable iris diaphragm controls width of the lower light
- Full-view gem clip
- Optional, overhead light source with fluorescent daylight light tube easily attaches to base. Fluorescent, daylight light source for diamond color grading (sold separately.)
- 360° rotating head
- Comfort eye guards
- Requires two bulbs



Item	Order #	Description	1+
A	29-4742	Elite 745 Zoom Microscope (without light)	\$549.00
B	29-4745	Replacement Bulb (29-4742), 6V/20W	\$23.95
C	29-4743	Optional Fluorescent Light Attachment	\$84.35
D	29-4746	Replacement Bulb (29-4743), 6V/12W	\$21.35



GEM ZOOM MICROSCOPE

Ideal for retail counter sales presentations.

- 10X-40X magnification
- Darkfield illumination
- Iris diaphragm for illumination control
- Overhead spot illumination
- Stone holder
- Designed for 110V and 220V



Item	Order #	Description	Power	1+
E	29-4780	Microscope	10X - 40X	\$397.15
F	29-4782	Replacement Bulb		\$3.55
G	29-4783	Replacement Iris		\$63.55



GEMOLOGICAL MICROSCOPE

- Great value at an affordable price
- View set and unset stones
- Versatile stone holder
- 20X-40X magnification
- Features built-in light and darkfield illumination



Item	Order #	Description	Power	1+
H	29-1605	Microscope	20X - 40X	\$279.00
J	29-4782	Replacement Bulb		\$3.55

DIAMOND INSCRIPTION READER DIGITAL MICROSCOPE

This Product is useful for Jewelers outlets, wholesalers or retailers gemological students. 3.5" Color LCD screen to identify the diamond laser inscription Works with Windows XP, Windows Vista, Windows 7, Mac OS 10.6 or later LED Illumination help to provide the best view. his Product is useful for Jewelers outlets, wholesalers or retailers gemological students.

Order #	Description	1+
13-1840	Inscription Reader™ Digital Microscope	\$279.00



DIAMOND GEM LIGHT

Lightweight and compact but big enough for the professional to grade diamonds and colored stones. It features a Verilux and UV long-wave light and has a deep grading cavity and a 90% cool white background that makes grading diamonds and detecting fluorescence in colored stones a breeze. Gemlight comes with a protective case, diamond cloth, and bulbs. Requires four AA batteries (not included).

Order #	Description	12+	6+	1+
13-1708	Gem Grading Light	\$84.32	\$89.28	\$99.20



DENSITY DIFFRACTION GRATING SPECTROSCOPE

Compact unit produces clear bright spectra with low intensity light. Pocket-sized spectroscope has fixed focus and slit.

Order #	Description	1+
29-3005	Spectroscope	\$115.00



CALCITE DICHROSCOPE

Determine if a stone is singularly or doubly refractive. Simultaneously view a gem's pleochroic colors in sharp contrast. Includes protective leather carrying case.

Order #	Description	12+	6+	1+
29-3002	Calcite Dischroscope	\$58.52	\$61.97	\$68.85





GEMORO LUMIGAUGE

Imagine a handheld gemological tool that featured quality 8X magnification under bright illumination, with a built-in precision 0.1mm measuring gauge.

Order #	Description	12+	6+	1+
29-2500	8X Magnification Gauge	\$17.98	\$19.04	\$21.15



See complete Loupe section starting on page 318.

CHELSEA COLOUR FILTER™ EMERALD LOUPE

Helpful for identifying certain red, blue, and green stones. Used to determine if a stone is natural or synthetic. Can also be used for detecting synthetic blue spinel and detecting dyes in certain gems. Made in England.

Order #	Description	12+	6+	1+
29-6505	Colour Filter Emerald Loupe	\$30.18	\$31.95	\$35.50



CZ MASTER COLOR SET

These CZ Master Sets have superior color accuracy and are hand graded against GIA® color master diamonds. All CZs in the set fall within the first half of the color grade and give equal spacing between color grades. All CZs are .80-1 carat diamond equivalent. Each set comes with a five-year manufacturer's warranty against color change.

Order #	Description	1+
29-2710	5-Stone Set: D, F, H, J, L	\$318.95
29-2711	5-Stone Set: E, G, I, K, M	\$318.95
29-2712	10-Stone Set: D, E, F, G, H, I, J, K, L, M	\$498.00



Find added video content on Stuller.com.

GEMORO CZ MASTER SET PRO

Professionally color grade diamonds in seconds. Each stone in the set is treated with GemOro's COLORLAST Technology to ensure permanent color saturation. It is expertly hand graded to master diamond color standards using the GIA® grading scale. Yellow and white simulated gold display ring stone holders included.

Order #	Description	12+	6+	1+
29-2714	10 Stone: 1 carat: E, F, G, H, I, J, K, L, M, N	\$335.75	\$355.50	\$395.00
29-2713	10 Stone: ½ carat: E, F, G, H, I, J, K, L, M, N	\$269.41	\$285.26	\$316.95



OPTICON FRACTURE SEALER

The standard sealer for sealing stone fractures. This sealer is highly effective in penetrating surfaces. Depending on the stone and mineral content, some of the fractures will not permit an invisible seal.

Order #	Description	12+	6+	1+
26-6008	Opticon Fracture Sealer	\$15.85	\$16.79	\$18.65

DIAMOND SHOVELS

Used for scooping and handling stones.

Item	Order #	Description	W x L	12+	6+	1+
A	51-0950	Nickel-Plated Chrome	1 3/4" x 3"	\$3.32	\$3.51	\$3.90
B	51-0951	Square Chrome-Plated	2 1/8" x 3 1/8"	\$2.13	\$2.25	\$2.50
C	51-0952	Black Finish	1 3/4" x 3"	\$2.93	\$3.11	\$3.45

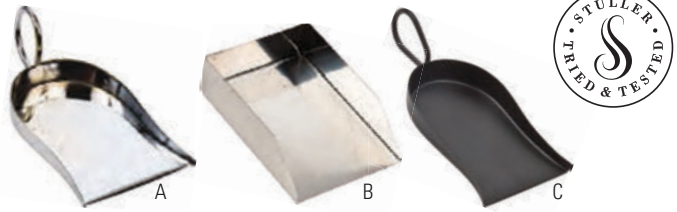

SORTING TRAYS

Grooved trays are used for sorting pearls, stones, and findings. Also has round indentations for size sorting as well.

Item	Order #	Description	W x L	12+	6+	1+
D	38-1003	Black Tray for Light Stones	7" x 3 3/4"	\$4.40	\$4.77	\$5.30
E	38-1002	Plastic Stone Sorting Tray	7" x 3 3/4"	\$4.40	\$4.77	\$5.30

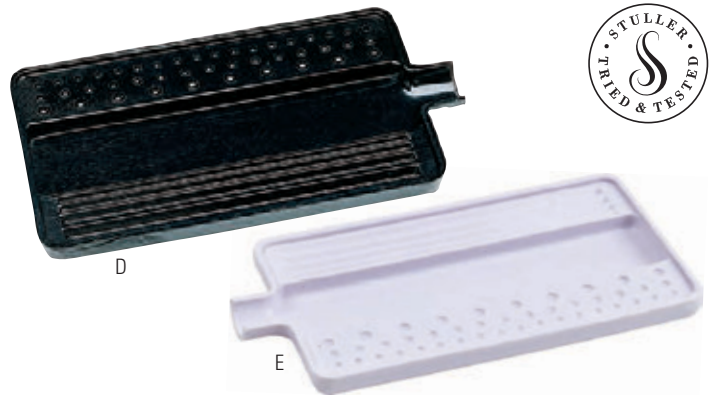

STONE SORTING TRAY

Used for sorting stones by size. Has various size grooves for easily sorting stones. Made of solid, tough, unbreakable plastic.

Order #	Description	W x L	12+	6+	1+
38-1000	Stone Sorting Tray	8 1/2" x 5 1/2"	\$4.88	\$5.09	\$5.30



GEM PAPER TRAYS

Ultra white trays come flat and are scored for easy folding. High quality and a true white makes them perfect for sorting and grading diamonds or other gemstones.



Order #	Description	W x L	12+	6+	1+
61-0547	Small Paper Tray	2 3/4" x 1 5/8"	\$4.18	\$4.32	\$4.80
61-0548	Large Paper Tray	5" x 1 5/8"	\$5.31	\$5.49	\$6.10



DISPLAY RINGS

Used to display diamonds and other precious stones. Provides a secure way to present loose stones to customer. Excellent sales aid.

Item	Order #	Description	12+	6+	1+
G	61-3000	Small Gold Ring Display	\$2.96	\$3.06	\$3.40
H	61-3010	Small Silver Ring Display	\$2.96	\$3.06	\$3.40
J	61-3020	Large Gold Ring Display	\$2.96	\$3.06	\$3.40
K	61-3030	Large Silver Ring Display	\$2.96	\$3.06	\$3.40



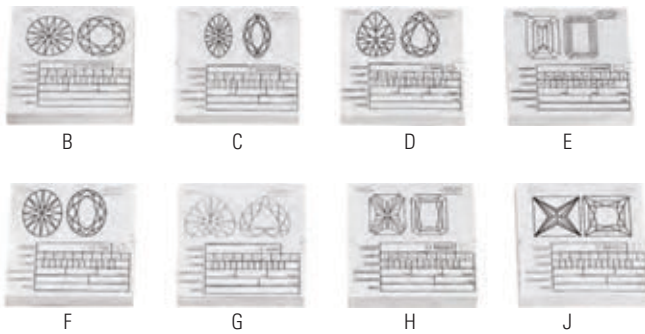

DIAMOND INFORMATION FACT LABELS

Diamond information fact labels are applied to diamond papers for quick and exact reference to the grade of the stones. The two-fold labels have both views of a diamond table up and table down, for plotting inclusions, carbon, and other identifying features. Self-adhesive label has a chart for listing weight, clarity, color, dimensions, comments, and prices. Assortment contains one pack of each shape. Individual shapes are sold in packs of 50.



Item	Order #	Description	W x L	12+	6+	1+
A	62-1240	8 Pack Assortment	3" x 3"	\$26.10	\$27.00	\$30.00
B	62-1241	Round	3" x 3"	\$10.14	\$10.49	\$11.65
C	62-1242	Marquise	3" x 3"	\$10.14	\$10.49	\$11.65
D	62-1243	Pear	3" x 3"	\$10.14	\$10.49	\$11.65
E	62-1244	Emerald	3" x 3"	\$10.14	\$10.49	\$11.65
F	62-1245	Oval	3" x 3"	\$10.14	\$10.49	\$11.65
G	62-1246	Heart	3" x 3"	\$10.14	\$10.49	\$11.65
H	62-1247	Radiant	3" x 3"	\$10.14	\$10.49	\$11.65
J	62-1248	Princess	3" x 3"	\$10.14	\$10.49	\$11.65

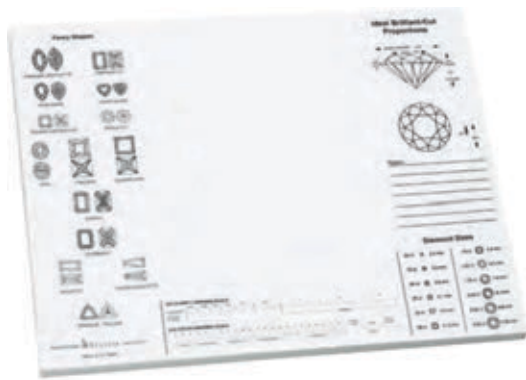

DIAMOND FACT SHEET

Professional looking diamond sheet for notating comments regarding the stones. Pad of 100.



Order #	Description	W x L	12+	6+	1+
61-1649	Diamond Fact Sheet	8½" x 11"	\$14.31	\$14.81	\$16.45



APPRAISAL FORMS WITH ENVELOPES

These repair order forms highlight specific areas to indicate issues for jewelry or watch repair. The triple form allows for individual copies for record keeping and customers. Pack of 50.



Item	Order #	Description	W x L	12+	6+	1+
K	61-1710	Appraisal Forms with Envelopes (Box of 50)	8½" x 11"	\$24.32	\$25.16	\$27.95



APPRAISAL FORMS

These repair order forms highlight specific areas to indicate issues for jewelry or watch repair. The triple form allows for individual copies for record keeping and customers. Pack of 100.



Item	Order #	Description	W x L	12+	6+	1+
L	61-1655	Appraisal Form	8½" x 11"	\$21.71	\$22.46	\$24.95

STONE PAPERS

European-style quality papers.
Folded size measures 3 1/8" x 1 3/4" (sold in packs of 25).



Item	Order #	Description	Color	12+	6+	1+
A	61-0517	Diamond Papers	Blue/Blue	\$5.18	\$5.36	\$5.95
B	61-0518	Diamond Papers	Blue/White	\$5.18	\$5.36	\$5.95
C	61-0519	Diamond Papers	White/White	\$5.35	\$5.54	\$6.15

GEMSTONE PAPERS

D	61-0535	Sapphire	Double White/White	\$2.91	\$3.02	\$3.35
E	61-0536	Opal	Double Black/Black	\$2.91	\$3.02	\$3.35
F	61-0537	Ruby	Double Yellow/Yellow	\$2.91	\$3.02 <td \$3.35	
G	61-0538	Emerald	Single Yellow	\$2.91	\$3.02	\$3.35

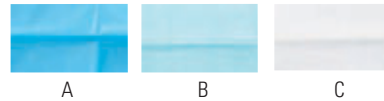
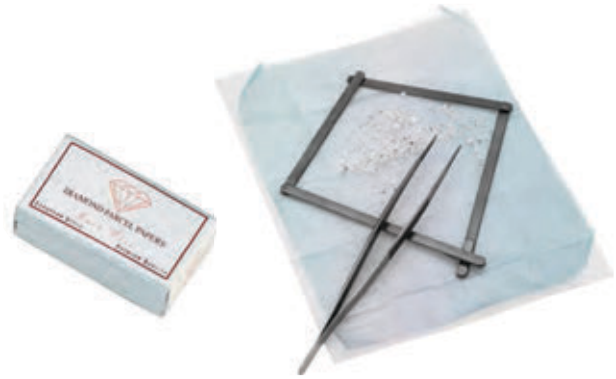

DIAMOND & GEMSTONES SUPPLIES

Heavy Paper Weight (folds up when not in use) 6 inch

Order #	Description	W x L	12+	6+	1+
62-0040	6" Diamond Paper Weight	6" x 6"	\$4.31	\$4.46	\$4.95
62-0044	Sorting Pad with White Paper and Heavy Cardboard Backing (50 sheets)	10" x 12"	\$10.23	\$10.58	\$11.73



GEMSTONE PARCEL BOXES AND WALLETS

H. Single row, black leatherette stone parcel box with soft-suede interior and removable inserts

J. Stone parcel box with soft-suede interior and removable inserts

K. Leather stone parcel box with zipper closure

L. Soft Black Pouch with Zipper Closure

Item	Order #	Description	W x L x H	12+	6+	1+
H	61-0552	Single Row Black Leatherette	4 1/4" x 10 1/4" x 3"	\$28.28	\$29.25	\$32.50
J	61-0554	Double Row Black Leatherette	8" x 12 3/8" x 2 7/8"	\$37.85	\$39.15	\$43.50
K	61-0540	Leather Stone Parcel Box	7" x 3 1/2" x 2 1/4"	\$14.75	\$15.26	\$16.95
L	61-0544	Soft Black Pouch	6" x 3 1/2" x 1 1/2"	\$13.62	\$14.09	\$15.65





DIAMOND INSCRIPTION VIEWER COMBO

The newly designed inscription loupe allows the user to view the certified number or information inscribed on the girdle of a diamond ring. It can also be used for loose stones with the aid of a stone holder or tweezers. The 20X triplet lens makes it easy to see the girdle of the stone. The swiveling pad allows you to view the ring in any direction.

Order #	Description	1+
26-2601	Inscription Reader™	\$57.00



PORTABLE POLARISCOPE

Easy to carry polariscope for testing single or double refraction, optical properties and pleochroism of gemstones. Comes with carrying pouch and flashlight.

Order #	Description	1+
26-2602	Polariscope	\$55.00



POLARISCOPE WITH DUAL LIGHT

The dual light polariscope will help to identify double refracting stones and to distinguish between many genuine gemstones and their simulants. It has transmitted illumination for the polariscope and side illumination that can be used as a light source for refractometers. Comes complete with a conoscope and AC adapter.

Order #	Description	1+
26-2603	Polariscope	\$98.00



REFRACTOMETER

The refractometer has readings from 1.31 to 1.81 with pull out eyepiece. It gives you clear focus and reading. It has polarizing filter, monochromatic filter, and light source, supplied with 1.8 "OR1" liquid.

Order #	Description	1+
26-2604	Refractometer	\$159.00

LEICA® BENCH MICROSCOPE

Ergonomically designed workstations have been proven to increase performance and the quality of work results. Leica® microscope systems' many years of experience in ergonomics is evident in the Leica® A60: the 38° viewing angle is close to a person's natural head posture. The zoom and focus knobs could not be more accessible; the rheostat of the focus drive can be adjusted to the preferences of a specific user. The operating elements of the ring illuminator are also intuitive and easily accessible, by left and right-handed users. The A60 has a large overview with a 46mm object field with approximately 100% greater depth of field and the working distance is 122mm.



Order #	Description	1+
29-4758	Microscope with Flex Arm Stand	\$2,075.00
29-4758	Horizontal Surface Mount	\$167.00
29-4758	Power Cord	\$30.00

MODE 360° PHOTO BOX

The MODE 360° Photo Box is a semi-automatic lightbox for taking professional pictures called packshots with maximum product size 15 x 15 x 15 cm. It is equipped with a built-in shadowless turntable necessary to compose 360 degree animations. Lighting is provided by a high quality LED system with optimal color temperature of light 6,500° K.

TECHNICAL SPECIFICATIONS:

- Dimensions: 60 x 60 x 60 cm
- Weight: 27 Pounds
- Power supply: 110-220 V
- Power consumption: 175 W
- Diameter of revolving platform: 40 cm
- Number of built-in lights: 5 below the turntable, 2 from top
- Max size of photographed object: 15 x 15 x 15 cm



Order #	Description	1+
29-0200	MODE 360° Photo Box	\$4,495.00

FLEXIBLE CAMERA STAND

The flexible camera stand is designed to work with the Dino Lite digital microscope (29-1502). It's tri-pod design with flexible legs allows you to wrap the legs around various objects to take pictures at many different angles.

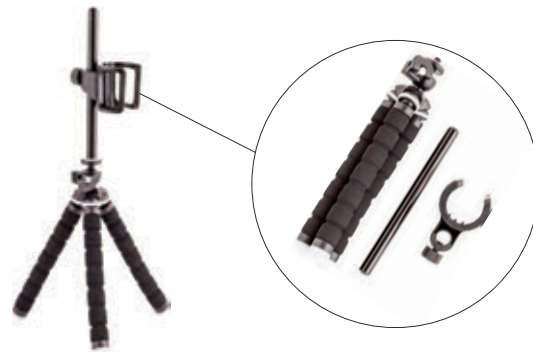

Order #	Description	1+
29-1499	Camera Stand	\$29.00

Hammers



GOLDSMITH



PLANISHING



FRETZ HAMMERS

Fretz Hammers feature beautiful and strong Padauk wood handles, oil finished and tapering to a slender neck for flexibility. The head is cast from 420-grade stainless steel and hardened to 50HRC for maximum durability. Faces are polished to a mirror shine.

Order # 37-1550

Item	Description	Length	Head Size (mm)	12+	6+	1+
GOLDSMITH						
A	HMR-21	9"	17	\$45.99	\$48.69	\$54.10
PLANISHING						
B	HMR1	9"	19	\$45.99	\$48.69	\$54.10
C	HMR-7 with 9 Inserts	9"		\$66.30	\$70.20	\$78.00
RAISING						
D	HMR-2 Wide	9"	11x9, 8x19	\$45.99	\$48.69	\$54.10
E	HMR-3 Narrow	9"	7x19, 3x19	\$45.99	\$48.69	\$54.10
F	HMR-12 Sharp Texturing	9"	3x19, 1.5x19	\$45.99	\$48.69	\$54.10
G	HMR-4 Large Embossing	9"	12, 16	\$45.99	\$48.69	\$54.10
H	HMR-5 Small Embossing	9"	5, 7	\$45.99	\$48.69	\$54.10
CHASING						
J	HMR-17	9"	22	\$48.62	\$51.48	\$57.20

RAISING

CHASING



K



L



M



N



BENCH ANVILS

Item	Order #	Description	Diameter	12+	6+	1+
	37-1551	Kit		-	-	\$260.00
K	37-1552	Flat	2 3/4"	\$62.77	\$66.47	\$73.85
L	37-1553	Low Dome	2 3/4"	\$62.77	\$66.47	\$73.85
M	37-1554	Medium Dome	2 3/4"	\$62.77	\$66.47	\$73.85
N	37-1555	High Dome	2 3/4"	\$62.77	\$66.47	\$73.85

HOLDER FOR FRETZ STAKES

Fretz Stake Holder is used for the 100 series stakes. This holder securely supports stakes during use. Can be mounted to a wood bench or block.

Order #	Description	Length	Width	12+	6+	1+
37-1559	Stake Holder	3½"	10mm	\$46.75	\$49.50	\$55.00

**100 SERIES STAKES**

Fretz 100 series stakes.

Order # 37-1560

Model	Description	Length	12+	6+	1+
M-102	Low Dome Mushroom	1¾"	\$30.60	\$32.40	\$36.00
M-103	Flat Mushroom Stake	1¾"	\$28.90	\$30.60	\$34.00
M-104	Large Concave Stake	2½"	\$49.30	\$52.20	\$58.00
M-105	Medium Concave Stake	1¾"	\$43.35	\$45.90	\$51.00
M-107	Extra Concave Cone Stake	2"	\$66.30	\$70.20	\$78.00
M-108	Slope Large Concave Stake	2"	\$53.55	\$56.70	\$63.00
M-110	Sloped Convex Cone Stake	2"	\$68.85	\$72.90	\$81.00
M-112	Convex Cuff Stake	1¾"	\$54.40	\$57.60	\$64.00
M-113A	Convex Cuff Stake	1¾"	\$36.55	\$38.70	\$43.00
M-113B	Convex Cuff Stake	1¾"	\$36.55	\$38.70	\$43.00
M-117	Flat Cuff Stake	2¼"	\$84.15	\$89.10	\$99.00
M-118	Flat Cuff Stake	2¼"	\$78.20	\$82.80	\$92.00
M-122	Shallow Concave Stake	2¾"	\$48.45	\$51.30	\$57.00
M-123	Minimal Concave Stake	2¾"	\$48.45	\$51.30	\$57.00

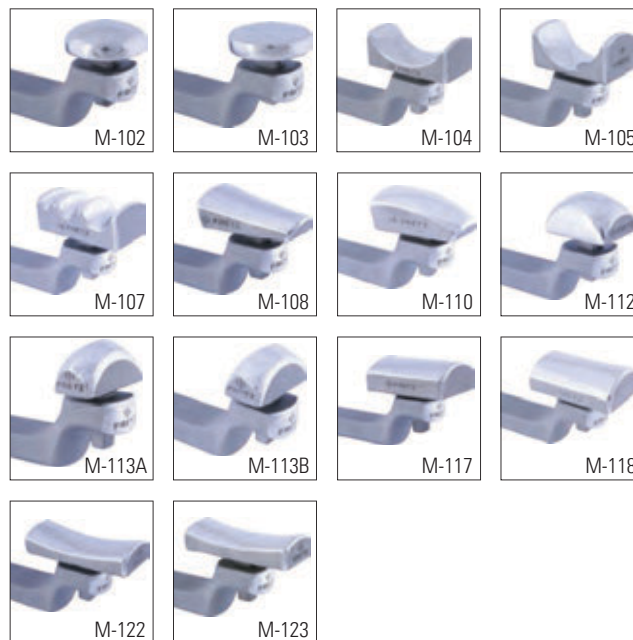
**DVD SET**

Fretz DVD set and tools is an amazing buy for your bench. This is a top-quality, professional tools kit that can last a lifetime. This set gives you everything you will need for your top-quality jewelry making needs.

Included in this set:

- Jeweler's planishing hammer, HMR-1; 88g head (37-1550)
- Jeweler's wide raising hammer, HMR-2; 85g head (37-1550)
- Jeweler's narrow raising hammer, HMR-3; 78g head (37-1550)
- Jeweler's double-ended hammer with inserts, HMR-7 (37-1550)
- Jeweler's rounded narrow raising hammer, HMR-8
- Jeweler's rounded wide raising hammer, HMR-9
- Steel stake holder, H-1 (37-1559)
- Double convex forming stake, F-2; 75 x 14.5mm (37-1557)
- Convex lining fluting stake, F-2A (37-1558)
- Convex sharp fluting stake, F-2B (37-1558)
- Convex extreme sharp fluting stake, F-2C
- Shell forming stake, F-6; 97 x 15mm (37-1557)
- Convex/concave forming stake, F-9; 77 x 13mm (37-1557)

Also included is the 90-minute DVD "Metalsmith Essentials: Basic Jewelry Hammering and Forming with Bill Fretz". This DVD puts renowned expert metalsmith and tool designer Bill Fretz right in your reach. You can learn from the ground up, starting with basic convex and concave forming techniques and continuing through eight lessons to begin mastering techniques such as planishing, raising, using stakes to form and flute metal, and many others. This is a set you want to have for all of your jewelry making needs.



Order #	Description	1+
37-1561	DVD with Tools Set	\$750.00

Hammers



HOLLOW RING STAKES

The R-1 and R-2 are raising stakes used to create bezels and stretch metal to fit custom stones.

Order # 37-1556

Model	Description	1+
R-2	Tapered Rounded Raising Stake	\$45.00
R-1	Standard Raising Stake	\$45.00



FORMING STAKES

- The F-1 is a BEAK STAKE that allows you to expand your forming and shaping skills. With this beak stake you can roll the edge of a cone or tube shape inward and will make a slightly tapered end than other stakes.

- The F-2 is a DOUBLE CONVEX STAKE that will allow you to build your forming and shaping skills, allowing you to create domes. On the larger end of the stake you will be able to create bold, curved shapes; the smaller end allows you to create smaller radius shapes.

- The F-3 is a DOMING STAKE is used to form bezels, make hollow rings or perform any type of smithing that you could do with larger stakes, but on a smaller scale.

- The F-6 is a SHELL STAKE that allows you to increase your forming and shaping skills. This shell stake is used for bracelet-sized work, using this stake you can form dramatic concave shapes and small convex shapes.

- The F-8 is a HORN STAKE that allows you to increase your forming and shaping skills. This horn stake allows you to create a more domed shape. Used in large part to make hollow rings and large beads for tubing.

- The F-9 is a CONVEX/CONCAVE STAKE that will allow you to increase your forming and shaping skills. The curve end of this stake will give you a more subtle curve; and the concave end forms more concave shapes on cylinders and bracelets.



Order # 37-1557

Model	Description	1+
F-1	Beak Stake	\$54.00
F-2	Double Convex Stake	\$54.00
F-3	Doming Stake	\$54.00
F-6	Shell Stake	\$54.00
F-8	Horn Stake	\$54.00
F-9	Convex/Concave Stake	\$54.00



PROGRESSIVE STAKES

Fretz new forming stakes have progressively sharper angles. These you can make fluted designs.

Order # 37-1558

Model	Description	1+
F-2B	Convex Fluting Medium/Sharp	\$54.00
F-2A	Convex Fluting Rolled Edge	\$54.00

GERMAN HAMMERS

The finest German-made hammers available. Precisely ground and hardened, each hand-forged steel head has highly polished tips and is mounted on a hickory handle. Each hammer offers just the precise weight and balance.

SILVERSMITHS' HAMMERS

Basic and essential for all metal work. Suitable for a wide range of objects from small spoons to large trays.

- A. Length: 5" (127mm)
- Weight: 10 oz
- Small End: 13/16" (21mm)
- Large End: 7/8" (22mm)

Item	Order #	Description	Length	Head Size	1+
A	37-1230	Hammer	5"	7/8"	\$55.70

PLANISHING HAMMERS

These planishing hammers are ideal for smoothing out imperfections and finishing surfaces that have been raised.

- B. - Length: 4 3/8" (111mm)
- Weight: 14 oz
- Small End: 1" (25mm)
- Large End: 1 1/8" (29mm)
- C. - Length: 3" (76mm)
- Weight: 7 oz
- Small End: 1 5/16" (24mm)
- Large End: 1" (25mm)

Item	Order #	Description	Length	Head Size	1+
B	37-1240	Hammer	4 3/8"	1/2 x 1"	\$55.70
C	37-1241	Hammer	3"	1 1/4"	\$55.70

EMBOSSING HAMMER

When driven against the inner walls of raised work, the embossing hammer can elevate positions of the surface. Can also be used for planishing.

- D. Length: 3" (76mm)
- Weight: 7 oz
- Small End: 1 5/16" (24mm)
- Large End: 1" (25mm)

Item	Order #	Description	Length	Head Size	1+
D	37-1250	Hammer	3"	1"	\$55.70



DELTRIN ADVANCED FORMING STAKES

Synclastic forming is the technique by which bowl-like metal shapes are created. Anticlastic forming results in a shape resembling a saddle. These advanced forming stakes are constructed from Delrin, a polymer notable for its high strength, hardness, and rigidity. Steel stakes require a good deal more planishing and provide somewhat less control than this range of stakes. Designed to be mounted in a bench vise. Made in the USA.

Item	Order #	Description	W x L x H	12+	6+	1+
E	37-5404	1/8" Forming Curve	1/2" x 8" x 1"	\$66.26	\$70.16	\$77.95
F	37-5403	1/4" Forming Curve	1" x 9 1/2" x 1 1/2"	\$66.26	\$70.16	\$77.95
G	37-5402	1 1/2" Forming Curve	1" x 9 3/4" x 1 1/2"	\$55.63	\$58.91	\$65.45



Hammers

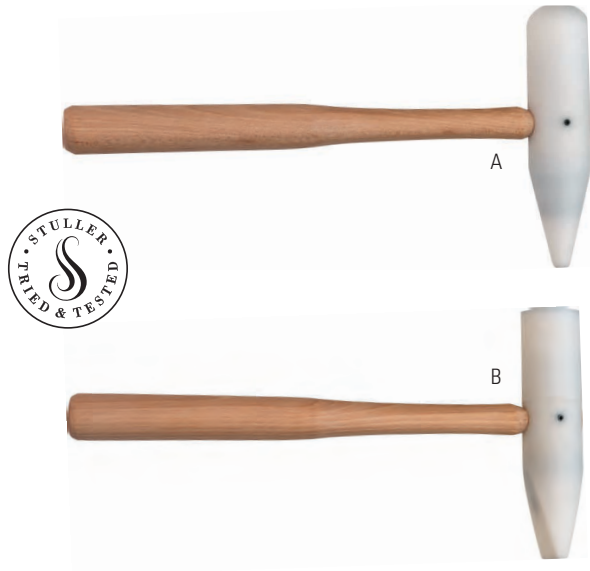

RASING HAMMER

These hammers are made of Delrin, a long lasting, non-marring material, perfect for forming and shaping non-ferrous metals using a stake. With its dead blow design there is little to no recoil when you strike, making it easy-to-use for long periods of time. Made in the USA.

Item	Order #	Description	Length	Head Size	1+
A	37-5401	Round	10½"	1¼"	\$50.95
B	37-5400	Flat	10½"	1¼"	\$50.95



TEXTURING HAMMER

With this hammer, the possibilities for patterns are endless. Never before has a hammer been designed to do so much. Use the small designs to pinpoint texture in a certain area and the large designs to cover a bigger area or use multiple tips to layer textures over one another. Each tip is easily and securely attached with a threaded collar. The tips are approximately ¾" with various textures.

Order #	Description	Length	Head Size	1+
37-2169	Hammer with 9 Faces	9½"	½"	\$47.35

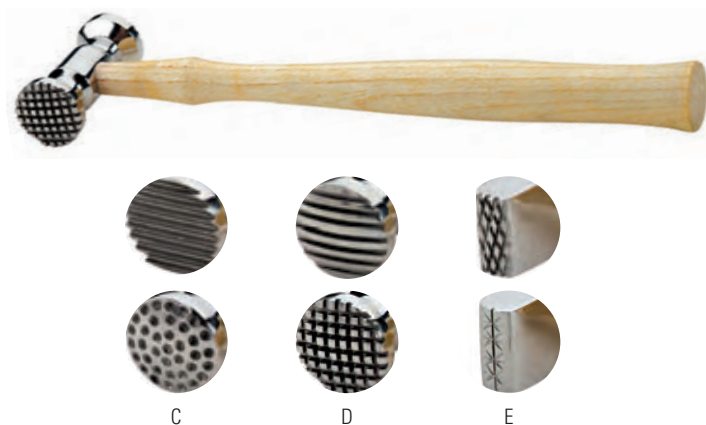

TEXTURING HAMMER

These texturing hammers are for non-ferrous metals. Double-sided, they enable the user to make attractive patterns to give jewelry and other metal items a unique look. Two different patterns on each side.

Item	Order #	Description	Length	Head Size	1+
C	37-2170	Sharp Stripe and Dimples	10"	2½ x 1½"	\$20.70
D	37-2171	Checkered and Wide Stripe	10"	3½ x 1½"	\$20.70
E	37-2172	Crosshatch and Stars	10"	2¾ x 1 x ¾"	\$20.70



MASTER-QUALITY, BALL PEEN HAMMER

Used for flattening, shaping, or removing dents. Made of high-carbon steel that provides extra strength for driving chisels, punches, and other tools.

Item	Order #	Description	Length	Head Size	1+
A	37-1220	2 oz Peen Hammer	10"	2"	\$22.05
B	37-1202	4 oz Peen Hammer	10"	2½"	\$22.05



GOLDSMITH HAMMER

Used for working on rings for sizing. Head has one round/flat end, 5/8" diameter and one chisel-shaped end. Has sturdy hardwood handle.

Order #	Description	Length	Head Size	1+
37-0409	4 oz Hammer	11⅞"	2⅝"	\$34.80



NYLON HAMMER

Seasoned ash handle with a drop-forged head and two nylon faces. Measures 1⅞" (27mm). Faces can be removed with a half-turn. Made in Germany.

Item	Order #	Description	Length	Head Size	1+
C	37-5310	Nylon Hammer	10"	1¾"	\$14.10
D	37-5315	Replacement Faces		1¾"	\$5.50



BRASS HAMMER

With hardwood handle. This hammer will provide years of service.

Order #	Description	Length	Head Size	1+
37-5300	Brass Hammer	10"	1¾"	\$8.15



MALLETS WITH DETACHABLE FACES

Faces can be changed to provide any combination desired. Faces can also be replaced when worn. Sold with two different faces and a wrench to tighten or remove collars. Faces are brass and nylon.

Item	Order #	Description	Length	Head Size	1+
E	37-5360	2½ oz Mallet	9"	2"	\$13.60
F	37-5840	5 oz Mallet	9"	2⅝"	\$17.60

REPLACEMENT FACES

G	37-5502	Nylon		\$1.45
H	37-5500	Brass		\$1.45
J	37-5902	Nylon		\$1.45
K	37-5900	Brass		\$1.70





GRS® CHASING HAMMER

These hammers are made from carefully heat-treated high alloy tool steel. The heads have a rich black oxide color treatment applied and then each end is beautifully hand polished. The hardwood handles are made from carefully selected wood that is superior to the wood used on lower quality hammers. The balance and fine craftsmanship of these chasing hammers add precision and satisfaction to your work.

Item	Order #	Description	Length	Head Size	1+
A	37-0363	Flat	10"	½ x 1"	\$41.55
B	37-0364	Round	10"	½ x 1"	\$41.55



CHASING HAMMER

Designed for silversmiths and arts and crafts work. Flat head is used to flatten, shape, and form objects to strike chasing tools. Round end is used for forming decorative patterns and designs. Made with hardwood handles. The forged head is wedge-mounted.

Item	Order #	Description	Length	Head Size	1+
C	37-0365	Chasing Hammer	10"	1"	\$14.30
D	37-0366	Chasing Hammer	10"	1½"	\$15.40
E	37-0367	Chasing Hammer	10"	1¼"	\$16.50

REPLACEMENT CHASER HARDWOOD HANDLES

J	37-0410	Pistol Handle	10"		\$5.70
K	37-0411	Round	10"		\$6.05
L	37-0412	Oval	10"		\$7.45



RIVETING HAMMER

Used for forming, riveting, and tacking. One end is flat, and the other is chisel-shaped. Drop-forged, polished head is mounted on select hardwood handle. Face diameter ½".

Item	Order #	Description	Length	Head Size	1+
F	37-2160	4 oz Riveting Hammer	9"	½"	\$32.35
G	37-2180	5 oz Riveting Hammer	9"	½"	\$35.85



ROUND FACE RIVETING HAMMER

One end is flat for general purpose, and the other end is chisel-shaped for spreading rivet heads. Round ⅜" face diameter. Made in Germany.

Item	Order #	Description	Length	Head Size	1+
H	37-2150	Riveting Hammer	9"	⅜"	\$25.25

BRASS HAMMER

Soft, yellow brass heads and cushion, rubber grips offer non-marring striking on all metal surfaces. Perfect for stamping, dapping, chasing, using with design stamps, and using with disc cutters.

Item	Order #	Description	Length	Head Size	1+
A	37-5320	1 lb Brass Hammer	9"	¾"	\$26.45
B	37-5321	2 lb Brass Hammer	9"	1⅞"	\$39.95

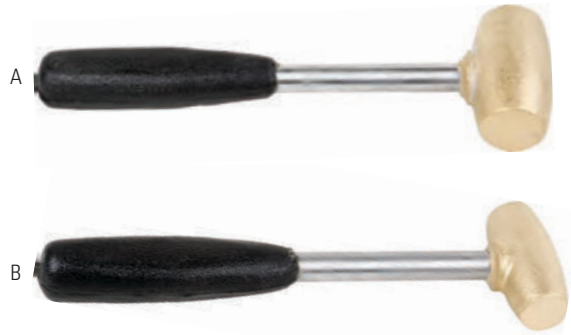

PLASTIC MALLET

Made of durable, non-porous plastic with hardwood handle. Easy-to-clean. Non-marring plastic cushions the shock at impact. Has the "bounce back" similar to a rawhide mallet.

Order #	Description	Length	Head Size	1+
37-7070	4 oz Mallet	9"	1¼"	\$11.20
37-7071	6 oz Mallet	9"	1½"	\$10.35
37-7072	9 oz Mallet	9"	1¾"	\$15.30
37-7073	14 oz Mallet	9"	2⅛"	\$16.40



ELASTOMER MALLET

Features an advanced resin material for long-lasting durability. Extra-long wooden handle protects hands.

Order #	Description	Length	Head Size	1+
37-3030	11 oz Mallet	9"	2"	\$39.65



GARLAND RAWHIDE MALLET

Heads are made of the finest quality, specially treated rawhide, which will not mark or scar metal. Handles are made of hardwood. Made in the USA.

Item	Order #	Description	Length	Head Size	1+
C	37-7000	2 oz Mallet	10"	1"	\$15.50
D	37-7001	4 oz Mallet	9"	1¼"	\$17.60
E	37-7002	6 oz Mallet	9"	1½"	\$20.70
F	37-7003	9 oz Mallet	9"	1¾"	\$22.80
G	37-7004	11 oz Mallet	9"	2"	\$25.90



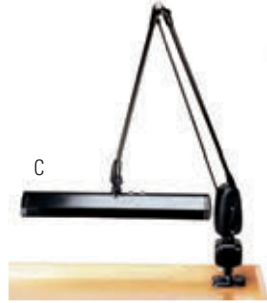

New power switch

"FLOATING-ARM" JEWELER'S LAMP

Dazor® tube lamps are supplied with 15 watt daylight tubes (6500°K) for a natural light. Your choice of two or three tube models. The Dazor® Floating Arm is easily positioned with a touch of a finger and will stay where you put it without springs or tightening screws. Rugged all metal construction has no exposed springs or wires. Now finished with powder coat for years of lasting use. Available in several colors, desk base models, clamp models, and two arm lengths. Clamp models will also fit into our bench-friendly Bushing Mount (13-1823). Tubes/bulbs not covered by five-year warranty.

Item	Order #	Color	Base Type	Arm Reach	1+
TWO TUBE LAMPS					
A	13-1802	Dove Gray	Desk Lamp	33"	\$232.05
B	13-1803	Black	Desk Lamp	33"	\$243.80
C	13-1801	Black	Clamp	43"	\$209.95
D	13-1800	Dove Gray	Clamp	43"	\$209.95
THREE TUBE LAMPS					
E	13-1808	Black	Desk Lamp	27"	\$262.15
	13-1821	Dove Gray	Clamp	33"	\$232.45
	13-1805	Dove Gray	Clamp	43"	\$225.95
	13-1806	Black	Clamp	43"	\$225.95

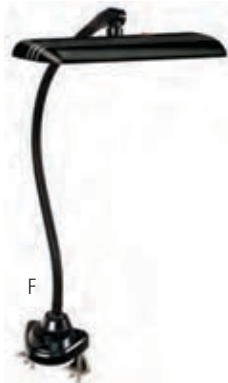

DAZOR® LED DIAMOND LIGHTS

These LED Diamond Lights are a combination of proven technology, cutting-edge research, and product development. Dazor's "Floating Arm" lighting solutions have been the industry standard in the jewelry industry since 1938. Our use of advanced technology coats the ore boards with a ceramic material that naturally dissipates the heat; no irritating, noisy fans. UV wavelength has been limited from the LED light spectrum. The light pattern from Dazor's LED luminaire is diffuse and color consistent. The phosphorous coating used in the powerful ½W LED produces a single, white light. No striping, patterns of illumination "blotches," nor color distortion are present in the pattern of illumination. One-year warranty

Item	Order #	Arm Type	Color	Base Type	Arm Reach	1+
F	29-4776	Flexible Arm	Black	Clamp	22"	\$329.95
G	29-4777	Classic Arm	Black	Clamp	34"	\$329.95
H	29-4778	Classic Arm	Black	Clamp	24"	\$329.95
J	13-1799	Flexible Arm	Black	Clamp	25"	\$160.40



BENCH-FLEX JEWELER'S LAMP

Designed by a bench jeweler for Dazor®, the Bench-Flex is made for the unique lighting demands of jewelry production. It can be moved to any angle for shadow-free or high-light viewing. The gooseneck is heavier than one would expect. It stays in position and does not droop. Bench-Flex is mounted on a 22" flex-arm with 30" reach, comes with two 15 watt (6500°K) daylight tubes and our bench-friendly bushing mount for mounting directly into the bench or desk top. Its rugged all metal construction and durable powder coat allows for years of lasting use. Tubes/bulbs not covered by five-year warranty.

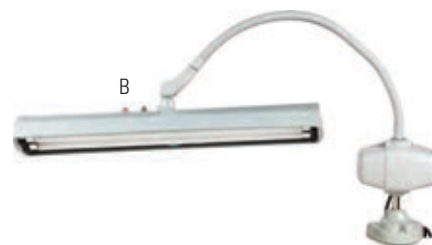

Item	Order #	Description	Color	Arm Reach	1+
A	13-1814	Flex Lamp	Black	30"	\$200.00
B	13-1817	Flex Lamp	Dove Gray	30"	\$200.00

DAZOR® FLUORESCENT BULBS

The different types of lights come in several different color temperatures to best fit your needs.

Item	Order #	Description	Color Range	Color Temp	1+
C	13-1824	Tube	Cool White	4,100° K	\$8.95
	13-1824	Tube	Daylight	6,500° K	\$9.95
	13-1824	Tube	Full Spectrum	5,500° K	\$19.95
	13-1810	Tube	Daylight	6,500° K	\$13.95
D	13-1820	U-Shape	Full Spectrum	5,000° K	\$17.00
	13-1820	U-Shape	Cool White	4,100° K	\$19.95



DAZOR® MOUNTS

Item	Order #	Description	Color	1+
E	13-1000	Ballast	—	\$15.95
F	13-1823	Bushing	Black	\$26.25
G	13-1825	Clamp Base	Dove Gray	\$42.30
	13-1826	Clamp Base	Black	\$42.30
H	13-1831	Horizontal Clamp	Dove Gray	\$28.95
	13-1831	Horizontal Clamp	Black	\$28.95
J	13-1833	Wall Mount/Table Base	Black	\$53.80
	13-1833	Wall Mount/Table Base	Dove Gray	\$53.80
K	13-1834	Back Splash Clamp	Black	\$53.80
	13-1834	Back Splash Clamp	Dove Gray	\$53.80
L	13-1792	Clamp Mount	—	\$54.00

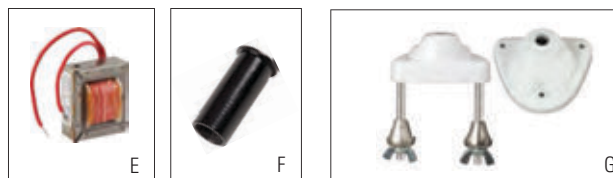

Lamps



DAZOR® ECOFLEX

The innovative new Wolf EcoFlex LED Bench Light by Dazor® is rugged and environmentally friendly LED bench light. The sleek head rotates 340 degrees vertically and 90° horizontally, and features 7 x 1-Watt dimmable high brightness white LEDs optically mixed to produce an even light pattern. The 25" flexible arm exceeds the depth of most jewelry benches and allows you to aim the light exactly where you need it, without the heat! The light features a grooved aluminum head design that removes heat and is comfortable to the touch. Dazor's clever thermal engineering allows the LEDs to achieve their rated life of 50,000 hours.

- Illumination is optically mixed for smooth, diffuse light output
- Beam of light can be positioned directly where needed
- Long arm reach 25"(63cm) exceeds depth of any jewelry bench
- Splash guard to protect against debris and liquids
- Dimmable down to 25% of full intensity
- Grooved aluminum head removes heat; comfortable to touch

Order #	Description	1+
13-1798	LED Bench Light	\$199.95



INSPECTION LAMP

Illuminated magnifier provides hands-free viewing and allows you to see greater detail while reducing eye strain. This clamp-on lamp provides focal length and the 3-diopter lens magnifies an object by 75%. The floating arm requires only a slight touch to raise, lower, or tilt. Supplied with a 22 watt Circline fluorescent bulb.

Item	Order #	Description	1+
A	13-2016	Inspection Lamp	\$48.15
B	13-8123	Replacement Bulb	\$19.95



PORTABLE FOLDING LAMP

Reasonably priced portable folding light with a 13 watt daylight bulb.

Item	Order #	Description	1+
C	13-1701	Black Folding Lamp	\$26.45
D	13-1709	Replacement Bulb	\$5.05



GEMORO® HORIZON LED DAYLIGHT DIAMOND COLOR GRADING LAMP

6000kt full spectrum natural daylight illumination task lamp with UV-free natural daylight illumination. It's sleek, flexible, ergonomic design with superior LED lighting is perfect for jewelers, artists, hobbyists, students, and more. Features a touch sensor power switch and dimmer, USB port for charging smartphones, ipods, etc. Fully adjustable light angles and multi-voltage adaptor.



Order #	Description	1+
13-1723	Black LED Task Lamp	\$119.95
13-1723	Slate LED Task Lamp	\$119.95

MK DIGITAL LED FLEXIBLE BENCH LIGHT

This light is a breakthrough in illumination intensity. It provides 100% even illumination throughout the entire length of the light. The cool white color temperature (5500°K) unleashes the fine qualities of your jewelry. No other light source can match the prismatic effect of laboratory graded LEDs light the fire in your diamonds. It is UL approved and guaranteed in international standards of safety.

- Made by aluminum extrusion. The fan-cooled LED provides for an exceptional long life. No ultraviolet or infrared radiation. Energy saving product—only uses 3/4 of an amp per linear foot.

One year warranty.



Item	Order #	Description	1+
A	13-1719	LED Light	\$324.95
B	13-1719	Diffuser Plate	\$42.95

TABLE TOP INSPECTION LAMP

- 11w fluorescent bulb
- 1-3/4x magnification
- Sturdy construction
- Flip-up lens cover
- Weighed base
- Moveable arm
- Color-White

Order #	Description	1+
13-4000	Inspection Lamp	\$25.95





LED INSPECTION LAMP

- Bright LED lights, 72 bulbs
- 1¾ X magnification
- Moveable arm
- Flip-up lens cover
- Weighted base
- Sturdy Construction
- Color: White

Item	Order #	Description	1+
A	13-4100	LED Lamp	\$79.00

LED TABLE TOP INSPECTION LAMP

- Bright LED lights, 72 bulbs
- 1¾ X magnification
- Moveable arm
- Flip-up lens cover
- Weighted base
- Sturdy Construction
- Color: White

Item	Order #	Description	1+
B	13-4200	LED Lamp	\$69.95

BENCH LAMP

Suitable for workshop or desktop use. Three fluorescent bulbs provide ample illumination. The innovative design allows the user to raise, lower, or tilt, directing the light source quickly and efficiently onto your work. - 110V/60HZ 3 x 14W - 14W T502

Item	Order #	Description	1+
C	13-4300	Bench Lamp	\$69.00

CIRCLINE MAGNIFIER

Designed for shadow-free inspection, soldering, and assembly work. The 3-diopter (75% magnification), 5"-crown optical glass lens has a focal length of 13". Rugged all-metal construction and durable powder coat allows for years of lasting use. Clamp models will also fit into our bench-friendly bushing mount (sold separately). Supplied with 22 Watt daylight tube (6500°K). Tubes/bulbs not covered by five-year warranty.

Item	Order #	Description	1+
D	13-8122	Clamp	\$231.75



DAZOR® HI-LIGHTER MAGNIFYING DESK LAMP

Uses a 13 Watt, compact fluorescent tube (included) located behind the magnifying lens. The unique placement of the bulb casts light at an angle for highlighting object details. This unique shadowing feature makes details of uneven surfaces pop out to the viewer. This effect is especially well suited for precise details found in variations of an object's surface.

The 3-diopter (75% magnification), 5"- crown optical glass lens has a focal length of 13".

Rugged all-metal construction and durable powder coat allows for years of lasting use. Clamp models will also fit into our bench-friendly bushing mount (sold separately). Supplied with 13 Watt daylight tube (6500°K). Tubes/bulbs not covered by five-year warranty.



Item	Order #	Description	1+
A	13-1818	Magnifying Clamp Base Lamp	\$236.90
B	13-1819	Magnifying Desk Base Lamp	\$266.00

5" CLAMP-ON MAGNIFIER FOR BENCH LAMP

- 2X and 4X/1" window
- The magnifier is made from optical quality acrylic
- Ideal accessory for use in jewelry making
- Magnifier includes all hardware to install
- Magnifier will flip upwards when not in use

Order #	Description	1+
29-4790	Clamp on Magnifier	\$42.35

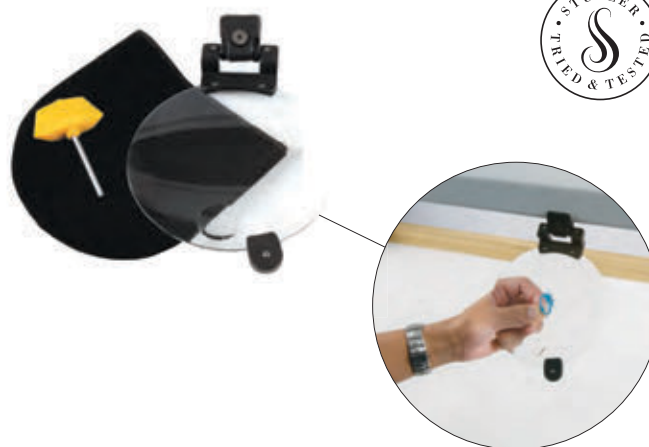

IVIEW HANDHELD LED/ UV MAGNIFIER

- Dual 5X and 10X magnification
- Crisp 55mm and 20mm optical quality lens
- 8 white natural daylight LED's and 1 UV LED
- Unique ergonomic design with a rubberized paint finish
- Includes 3 AAA batteries and carrying case
- May also be used for counterfeit bill identification and diamond fluorescence detection

Order #	Description	1+
29-2503	LED/ UV Magnifier	\$19.95





SUPER LIGHTWEIGHT LOUPE

These super lightweight professional triplet loupes are made of anodized aircraft-grade aluminum alloy housing. Triplet lenses are made by cementing three lens elements to form to one single lens for aplanatic and achromatic color corrections. 21mm, 10X hexagonal-cut shape, weight - 1.4 ounces.

Item	Order #	Color	Power	Lens Diameter	12+	6+	1+
A	29-6070	Red	10X	21mm	\$16.87	\$17.86	\$19.85
B	29-6071	Gray	10X	21mm	\$16.87	\$17.86	\$19.85
C	29-6072	Purple	10X	21mm	\$16.87	\$17.86	\$19.85
D	29-6073	Blue	10X	21mm	\$16.87	\$17.86	\$19.85
E	29-6074	Black	10X	21mm	\$16.87	\$17.86	\$19.85
F	29-6075	Gold	10X	21mm	\$16.87	\$17.86	\$19.85



LED ILLUMINATED TRIPLET LOUPE

The 10X lighted loupe features a 21mm achromatic-aplanatic lens and contains six bright white LED lights that illuminate your field of view. These lighted loupes are great for poor lighting conditions and have an on/off switch so they can be used with or without the light.

- Features diffused LED light source
- Comes in a leather carrying case
- Bright white LED light battery operated
- Three Energizer® 395/399 batteries included

Item	Order #	Description	Power	Lens			
				Diameter	12+	6+	1+
G	29-6775	LED Loupe	10X	21mm	\$25.29	\$26.78	\$29.75
H	29-6060	LED and UV Loupe	10X	21mm	\$35.28	\$37.35	\$41.50



LARGE HEX 10X LOUPE

These 10X triplet loupes offer a wide 21.5mm field of view. Case is hexagonal and the head is a 12-faceted design. Leather case included.

Item	Order #	Color	Power	Lens Diameter	12+	6+	1+
J	29-6047	Black	10X	21.5mm	\$14.15	\$14.99	\$16.65
K	29-6048	Gold	10X	21.5mm	\$13.47	\$14.27	\$15.85
L	29-6049	Silver	10X	21.5mm	\$14.15	\$14.99	\$16.65



TRIPLET HEXAGON LOUPE

M. Optically correct for distortion-free viewing from edge to edge with color-corrected lens. Glare is reduced by black frames. Extra-large field of view. Sold with leather carrying case.

N. Three-piece bonded lenses. Comes with protective leather case.

Item	Order #	Color	Power	Lens			
				Diameter	12+	6+	1+
M	29-6770	Chrome/Black	10X	20.5mm	\$11.69	\$12.38	\$13.75
N	29-2605	Chrome/Black	15X	20.5mm	\$19.85	\$21.02	\$23.35

CARL ZEISS 10X LOUPE

High performance, top quality 18mm optical loupe. The shape and function of the lens are a result of the latest research in the field of optics. The aplanatic-achromatic design of the lens is practically free of distortion and chromatic aberrations. Focal distance: 1". Made in Germany.



Order #	Color	Power	Lens Diameter	12+	6+	1+
29-2606	Black	10X	13mm	\$94.56	\$100.13	\$111.25

OVAL TRIPLET 10X LOUPE

These are high-quality Hastings Triplet Loupes. Hastings lenses are constructed from three lens elements cemented together to form a single lens. The unmatched clarity of our triplet loupes is further enhanced by black, outer lens edges, which eliminate color distortion. All loupes come in a hard leather case. Loupes are available in a variety of colors with or without a non-slip, rubber grip also engravable. Lens diameter 18mm.



Item	Order #	Color	Lens			12+	6+	1+
			Power	Diameter				
A	29-6010	Pearl White	10X	18mm	\$13.47	\$14.27	\$15.85	
B	29-6012	Blue Lapis	10X	18mm	\$13.47	\$14.27	\$15.85	
C	29-6013	Green Malachite	10X	18mm	\$13.47	\$14.27	\$15.85	
D	29-6014	Black Marble	10X	18mm	\$13.47	\$14.27	\$15.85	
E	29-6015	Pink Marble	10X	18mm	\$13.47	\$14.27	\$15.85	
F	29-6030	Gold	10X	18mm	\$11.05	\$11.70	\$13.00	
G	29-6031	Black	10X	18mm	\$11.05	\$11.70	\$13.00	
H	29-6032	Chrome	10X	18mm	\$11.05	\$11.70	\$13.00	



HEXAGON TRIPLET 10X LOUPE

These are high-quality Hastings Triplet Loupes. Hastings lenses are constructed from three lens elements cemented together to form a single lens. The unmatched clarity of our triplet loupes is further enhanced by black, outer lens edges, which eliminate color distortion. All loupes come in a hard leather case. Loupes are available in a variety of colors with or without a non-slip, rubber grip. Lens diameter 21mm.



Item	Order #	Color	Lens			12+	6+	1+
			Power	Diameter				
J	29-6020	Pearl White	10X	21mm	\$19.42	\$20.57	\$22.85	
K	29-6021	Blue Lapis	10X	21mm	\$19.42	\$20.57	\$22.85	
L	29-6022	Green Malachite	10X	21mm	\$19.42	\$20.57	\$22.85	
M	29-6023	Black Marble	10X	21mm	\$19.42	\$20.57	\$22.85	
N	29-6024	Pink Marble	10X	21mm	\$19.42	\$20.57	\$22.85	
P	29-6035	Gold	10X	21mm	\$15.30	\$16.20	\$18.00	
Q	29-6036	Black	10X	21mm	\$15.30	\$16.20	\$18.00	
R	29-6037	Chrome	10X	21mm	\$15.30	\$16.20	\$18.00	



VIGOR® ECONOMY LOUPE

Single lens loupe.

Item	Order #	Color	Lens			12+	6+	1+
			Power	Diameter				
S	29-6002	Black	10X	18mm	\$9.35	\$9.90	\$11.00	
T	29-6003	Gold	10X	18mm	\$11.86	\$12.56	\$13.95	
U	29-6005	Chrome	10X	18mm	\$9.35	\$9.90	\$11.00	



Loupes and Magnifiers



VIGOR® ECONOMY LOUPE

Triplet with rubber grip. Sold with leather carrying case.

Order #	Color	Power	Lens Diameter	12+	6+	1+
29-6000	Gold	10X	18mm	\$13.39	\$14.18	\$15.75



ECONOMY LOUPE WITH ALUMINUM HOUSING

Aluminum-body loupe doublet comes with box.

Order #	Color	Power	Lens Diameter	12+	6+	1+
29-7000	Silver	10X	15mm	\$3.27	\$3.47	\$3.85



DIAMOND-CUT LOUPE

Diamond-cut impressions are not only attractive but are also functional allowing the user a better grip.

Item	Order #	Color	Power	Lens Diameter	12+	6+	1+
A	29-6040	Black	10X	18mm	\$11.86	\$12.56	\$13.95
	29-6041	Silver	10X	18mm	\$11.82	\$12.51	\$13.90
	29-6042	Gold	10X	18mm	\$11.69	\$12.38	\$13.75
B	29-6043	Black	10X	21.5mm	\$13.56	\$14.36	\$15.95
	29-6045	Silver	10X	21.5mm	\$13.56	\$14.36	\$15.95
	29-6044	Gold	10X	21.5mm	\$13.47	\$14.27	\$15.85



HASTINGS TRIPLET 20X LOUPE

Item	Order #	Color	Power	Lens Diameter	12+	6+	1+
C	29-6050	Black	20X	18mm	\$17.00	\$18.00	\$20.00
D	29-6051	Gold	20X	18mm	\$17.00	\$18.00	\$20.00
E	29-6052	Chrome	20X	18mm	\$17.00	\$18.00	\$20.00



B&L® POCKET HASTING TRIPLET LOUPE

Bausch & Lomb's® finest quality loupe. This is one of the most highly corrected magnifiers available. The triplet lens system corrects spherical and chromatic aberrations. The wide field of view provides sharp focus and eliminates color degradation.

Item	Order #	Lens Quantity	Power	Working Distance	12+	6+	1+
F	29-2601	Triplet	10X	1"	\$44.63	\$47.25	\$52.50
G	29-2602	Triplet	14X	¾"	\$51.68	\$54.72	\$60.80
H	29-2603	Triplet	15X	½"	\$51.68	\$54.72	\$60.80

ESCHENBACH PRECISION FOLDING MAGNIFIERS

Body is made of reinforced glass-fiber, durable polyamide. The air tight body prevents dust, which produces scratches, from entering. Aplanatic lens provides a distortion-free image. The two planoconvex glass lenses offer distortion-free, superior optics throughout the viewing field.



Order #	Description	Color	Power	12+	6+	1+
29-4787	Aplanatic	Black	10X	\$95.20	\$100.80	\$112.00

ESCHENBACH METAL PRECISION FOLDING MAGNIFIERS

Traditional technical folding magnifiers provide the high power optics and durability to meet any industry standard. Aplanatic lens provides a distortion-free image. The two plano-convex glass lenses offer distortion-free, superior optics throughout the viewing field.



Order #	Description	Color	Power	Lens Diameter	1+
29-4788	Aplanatic	Silver	10X	17mm	\$133.80

CHELSEA COLOUR FILTER™ EMERALD LOUPE

Helpful for identifying certain red, blue, and green stones. Used to determine if a stone is natural or synthetic. Can also be used for detecting synthetic blue spinel and detecting dyes in certain gems. Made in England.



Order #	Description	Color	12+	6+	1+
29-6505	Colour Filter Emerald Loupe	White	\$30.18	\$31.95	\$35.50

B&L® SINGLE LENS LOUPE

Lightweight, black frames with soft, black, interior surfaces. Carefully ground lenses are polished from the best optical glass.

Item	Order #	Color	Power	Working Distance	12+	6+	1+
A	29-1300	Black	10X	1"	\$16.15	\$17.10	\$19.00
B	29-1301	Black	7X	1½"	\$14.03	\$14.85	\$16.50
C	29-1302	Black	5X	2"	\$14.03	\$14.85	\$16.50
D	29-1303	Black	4X	2½"	\$14.03	\$14.85	\$16.50



B&L® TRIPLE APLANATIC LOUPE

Corrected for spherical and chromatic aberration, little color degradation, and very sharp focus over the entire field of vision. One of the best triplets available. Made in Germany.

Item	Order #	Color	Power	Working Distance	12+	6+	1+
E	29-1304	Black	10X	1"	\$58.23	\$61.65	\$68.50



GEMORO® ORIGINAL AND VIP LITE LOUPES

Superior optical quality, crisp, distortion free, Hasting triplet lens with durable scratch resistant coating.

Item	Order #	Description	Power	Lens Diameter	1+
A	29-7201	Gold VIP Lite Loupe	10X	18mm	\$19.95
	29-7201	Silver VIP Lite Loupe	10X	18mm	\$19.95
	29-7201	Blue VIP Lite Loupe	10X	18mm	\$19.95
	29-7201	Black VIP Lite Loupe	10X	18mm	\$19.95
B	29-7202	Blue Triplet Loupe	10X	20mm	\$31.85
	29-7202	Silver Triplet Loupe	10X	20mm	\$31.85
	29-7202	Black Triplet Loupe	10X	20mm	\$31.85
	29-7202	Gold Triplet Loupe	10X	20mm	\$31.85



10X LIGHTED MAGNIFIER WITH MAGLITE®

Attached directly to the Maglite® is a 10X color-corrected compound triplet magnifier made of high-impact nylon composite with rubber eyepiece. The magnifier features a diffuser and one-way reflector so that the viewer's eye is directly above the light, giving the best possible view of diamonds, small gemstones, etc.

Order #	Description	Power	12+	6+	1+
29-6100	Magnifier with Maglite	10X	\$35.96	\$38.07	\$42.30



DIAMOND VIEW WITH MAGLITE®

Used with a Maglite, this instrument becomes a portable darkfield that allows the user to identify the fillings and flaws in diamonds. Features a high-intensity, miniature darkfield and distortion-free, 19mm, 10X triplet. Black-oxide finish allows glare-free viewing.

Order #	Power	Lens Diameter	12+	6+	1+
29-6500	10X	19mm	\$45.01	\$47.66	\$52.95



10X LED SCALE LOUPE

Order #	Description	12+	6+	1+
29-4769	10X LED Scale Loupe	\$38.21	\$40.46	\$44.95



LOUPE CHAINS AND CORDS

Item	Order #	Description	Length	12+	6+	1+
C	29-6016	Gold Tone (metal)	19"	\$6.59	\$6.98	\$7.75
D	29-6017	Silver Tone (metal)	19"	\$6.97	\$7.38	\$8.20
E	29-6018	Blue Cord	36"	\$3.70	\$3.92	\$4.35
F	29-6025	Black Cord	36"	\$5.78	\$6.12	\$6.80
G	29-6026	Red Cord	36"	\$5.78	\$6.12	\$6.80
H	29-6027	Gray Cord	36"	\$5.78	\$6.12	\$6.80
J	29-6028	Yellow Cord	36"	\$4.29	\$4.55	\$5.05

EUROSCOPE

This scope was created for the diamond end-user to view the unique “heart” and “arrow” patterns in ideal-cut or other special cut diamonds.

Item	Order #	Description	1+
A	29-4732	Diamond Viewer	\$59.95



DIAMOND INSCRIPTION VIEWER

Our consumer-friendly device holds a ring and easily allows the user to view the mounted diamonds certificate number, which is laser inscribed on its girdle. Featuring a HOYA 20X Hastings triplet lens, swiveling ring pad, and simple focusing that stays in focus when handed to your customers.

Item	Order #	Description	1+
B	29-4731	Inscription Viewer	\$48.95

OPTIVISOR® BINOCULAR MAGNIFIER

OptiVISOR® lenses are ground and polished to precision ophthalmic standards. The OptiVISOR® frame is made of lightweight, durable, impact-resistant materials. The comfortable, continuous headband is fully adjustable to fit any size, quickly and easily. Adjustable pivot knobs hold visor in any position for easy flip-up viewing. Interchangeable lens plates are available for various applications. Not intended for use while soldering.



Order # 10-10000

Sold Each

C. OptiVISOR	DA10	DA7	DA5	DA4	DA3	DA2
Focal Distance	4"	6"	8"	10"	14"	20"
Power	3½X	2¾X	2½X	2X	1¾X	1½X
1+	\$40.15	\$40.15	\$40.15	\$40.15	\$40.15	\$40.15

Order # 10-10002

Sold Each

D. Lens Plates	#10	#7	#5	#4	#3	#2
Focal Distance	4"	6"	8"	10"	14"	20"
Power	3½X	2¾X	2½X	2X	1¾X	1½X
1+	\$28.50	\$28.50	\$28.50	\$28.50	\$28.50	\$28.50



OPTIVISOR® ACCESSORIES

Item	Order #	Description	Power	1+
E	29-4700	OptiLoupe Attachment	2½X	\$12.50
	29-4702	Replacement Leather Headband		\$16.50
F	29-4703	Short Light Attachment		\$23.10





"EASY EYES" HEAD MAGNIFIER

This lightweight magnifier has four magnifications in one. Magnification ranges from 1.8X to 4.8X. Has a convenient, flip-down loupe.

Order #	Description	Power	12+	6+	1+
29-4730	Head Magnifier	1.8X - 4.8X	\$8.07	\$8.55	\$9.50



Plastic Lens

OPTIVISOR® LX

The OptiVISOR® LX lightweight lenses and tough materials are designed to last a lifetime. It has optical prismatic lenses from precision ground and highly polished molds. The LX has adjustable side pivots that allow the visor to tilt at your fingertips, and a dial adjustment headband that conforms to comfortably fit all head sizes. The LX has a genuine leather padded comfort band with orthopedic felt for extra comfort.

Order # 10-10001

Sold Each

OptiVISOR LX	LX 3	LX 7	LX 5	LX 4
Focal Distance	14"	6"	8"	10"
Power	1½X	2¾X	2½X	2X
12+	\$23.76	\$24.27	\$24.27	\$23.76
6+	\$25.16	\$25.70	\$25.70	\$25.16
1+	\$27.95	\$28.55	\$28.55	\$27.95



B&L® MAGNA VISOR

Lightweight, can be worn over prescription glasses. Shatter-resistant, precision, optical lenses sharpen the tiniest details. Adjustable, comfort-fit headband and interchangeable lens plates offer the best in comfort and visibility. Includes all three frames.

Order #	Description	Power	Focal Distance	12+	6+	1+
29-1313	Magna Visor	1.9X, 2.5X, 2.75X		\$39.78	\$42.12	\$46.80
REPLACEMENT LENS						
29-1310	Lens Plate	1.9X	12"	\$10.84	\$11.48	\$12.75
29-1311	Lens Plate	2.5X	8"	\$10.84	\$11.48	\$12.75
29-1312	Lens Plate	2.75X	6"	\$10.84	\$11.48	\$12.75



LED LIGHTING SYSTEM

Custom-fit lighting attachment for Optivisor type magnifying visor. This design utilizes the latest in LED technology. Reduces shadows and increases visibility in any environment. Lights up holes and deep cavities. Super long battery life. Light remains bright after 16 hours of straight use. Lasts up to 96 hours on a single set of batteries. Over 100,000 hour bulb life expectancy. Includes two AA batteries.

Order #	Description	Working Distance	12+	6+	1+
29-4781	LED Lighting System	6" - 14"	\$22.48	\$23.81	\$26.45

MULTIPLE-MAGNIFICATION HEADBAND MAGNIFIER

Four magnifications are built-in. The flip-down inner lens and the auxiliary loupe allow a range of magnification from 1¼" to 4¾" (44 to 121mm), with a working distance of 10" to 3" (254 to 75mm). Each side light requires two AAA batteries (not included).



Order #	Description	12+	6+	1+
29-5610	Black LED Magnifier with Headband	\$34.68	\$36.72	\$40.80

OPTISIGHT® VISOR

Provides hands-free magnification for more accurate and efficient viewing. The visor tilts up for normal viewing or down for magnification, and can also be worn over prescription glasses. Made of high strength plastic and precision optical grade acrylic prismatic lens. Comes with 3X, 4X, and 5X lenses.

Order # 29-6105

Sold Each

Color	Gray	Blue	Green	Purple	Red	Tan
12+	\$23.76	\$23.76	\$23.76	\$23.76	\$23.76	\$23.76
6+	\$25.16	\$25.16	\$25.16	\$25.16	\$25.16	\$25.16
1+	\$27.95	\$27.95	\$27.95	\$27.95	\$27.95	\$27.95



Blue



Gray



Green



Purple



Red



Tan

MEGA-VIEW COMPACT VISORS

Mega-View MG-2 and MG-3 includes 2X, 2.5X, and 3X lenses. Easy to use and comfortable head mount for stone setting.

Item	Order #	Description	12+	6+	1+
A	29-4738	Black MG-2 Headband	\$50.58	\$53.55	\$59.50
B	29-4739	Black MG-3 Lightweight Frame	\$50.58	\$53.55	\$59.50



A

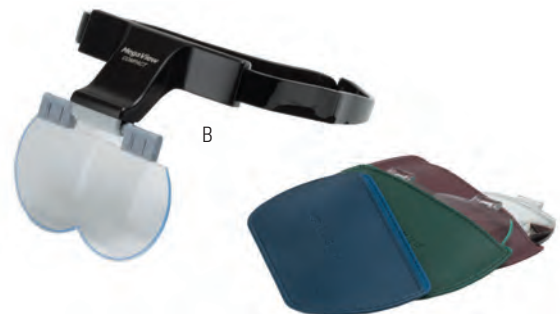

B



ESCHENBACH GALILEAN SYSTEM

Comes complete with a clip-on attachment for eye-glass wearers. It can be used with the attachment or without as a hand-held monocular. Black plastic, reinforced with fiberglass. Comes with simulated leather zippered case.

Order #	Lens	Focal Distance	Power	12+	6+	1+
29-4791	Double	3" - 13"	2.5X	\$609.28	\$645.12	\$716.80
29-4792	Double	1" - 10"	4X	\$609.28	\$645.12	\$716.80



A



B

ESCHENBACH MAX

A. Hands-free, head-mounted glasses provide 2X magnification and can be adjusted so that each eye lens can be focused separately [± 3 diopters]. The glasses will focus on near objects with working distances of 16 inches. Lens size: 32mm, lens material: PXM plastic, temple length: 135mm, bridge: open saddle, frame size: 137mm, visual field: 20°, PD range: 60mm-68mm, case included.

B. Telescopic magnification that attaches to prescription eyewear! Designed for patients who have a refractive error AND want the convenience of an off-the-shelf, near, telescopic system. 2X magnification, hands-free design, large working distance, and wide field of view. Five vertical lens heights from which to choose to assure correct pupil alignment. The convenient hinged clip mechanism allows the lenses to be flipped up, and out of the way, when not needed or not in use. Equipped with rubber-covered jaws to prevent the clip from scratching patient's eyewear. Provides the most valued benefit of a near Galilean telescopic system; a full 16 inch working distance! Case included.

Item	Order #	Description	Power	1+
A	29-7500	Max Detail Adjustable Magnifier	2X	\$199.60
B	29-7504	Clip-on Max Detail	2X	\$192.00



OBRIRA CHROME BINOCULAR MAGNIFIER

Provides a sharp, clear stereoscopic image with 2.3X magnification. The lightweight and comfortable design ensures fatigue-free wear. Both telescopes can be axially adjusted to fit your individual interpupillary distance. The Zeiss® quality loupes are manufactured in Germany and frames are available in silver plating on sports frames. The normal working distance or focal length is 10". Magnification: 2.3X Working Distances: 10" Field of View: 2"

Order #	Description	Lens	Power	Focal Distance	1+
29-4600	Binocular Magnifier	Single	2.3x	10"	\$583.00



ESCHENBACH SPECTACLE

These spectacle magnifiers are ideal for people who wish to engage in extended viewing tasks requiring high magnification with hands-free usage. Comes with either magnified right eye or left eye.

Order #	Description	Lens	Power	Focal Distance	1+
29-7505	Lens for Left Eye	Single	2X	10"	\$556.20
29-7505	Lens for Right Eye	Single	2X	10"	\$556.20

10X TRIPLET DIAMOND LOUPE

Triplet Diamond Loupe are constructed from three lens elements cemented together to form a single lens. Loupe comes in a hard leather case.

Order #	Description	12+	6+	1+
29-4779	Black 10X Triplet Diamond Loupe	\$83.30	\$88.20	\$98.00



OPTICAID® CLIP-ON MAGNIFIER

The ultra-light eyeglass loupe is designed for maximum comfort and utility. Lenses are high quality, optical-grade materials from precision-ground and polished molds. Very superior durability. The lens pivots out of the way for normal viewing and easily aligns when magnification is needed. Changeable cams are included to fit eyeglass frames from 1/16" to 1/4" temple width. The eyeglass clamp easily converts from right to left temple mounting. Made in the USA.

Order #	Lens	Lens Diameter	Power	12+	6+	1+
29-1400	Single	15mm	10X	\$20.83	\$22.05	\$24.50
29-1401	Single	24mm	7X	\$20.83	\$22.05	\$24.50
29-1402	Single	24mm	5X	\$20.83	\$22.05	\$24.50
29-1403	Single	24mm	4X	\$20.83	\$22.05	\$24.50
29-1404	Single	24mm	3X	\$20.83	\$22.05	\$24.50
29-1405	Double	24 and 15mm	5X and 10X	\$24.23	\$25.65	\$28.50
29-1406	Double	15 and 24mm	4X and 10X	\$24.23	\$25.65	\$28.50
29-1407	Double	25 and 25mm	5X and 7X	\$24.23	\$25.65	\$28.50
29-1408	Double	24 and 25mm	4X and 7X	\$24.23	\$25.65	\$28.50



B&L® METAL SPECTACLE LOUPES

Bausch & Lomb is pleased to bring back a classic. These eyeglass loupes set the standard for quality optics, and now they are back with major enhancements.

- Made with precision optical glass
- Ideal for any detail work
- Available in single or double lens configuration
- Supplied with a high-quality case to protect your investment

Order #	Lens	Focal Distance	Power	12+	6+	1+
29-1805	Single	1½"	7X	\$36.55	\$38.70	\$43.00
29-1807	Single	2½"	4X	\$36.55	\$38.70	\$43.00



ESCHENBACH MAGNIFIERS

Bi-convex PXM® lightweight lens. Handle and frame are transparent. Lens size: 30mm.



Order #	Description	Lens	Power	Per Pack	1+
29-7502	Magnifier	Single	5X	10	\$54.95





LED MAGNIFIERS

Clamping glasses magnifier with LED lamp makes both hands free. It can easily be used for reading, drawing, handicraft, tailoring, viewing plants, and more. Contains three changeable lens magnifiers (1.5X, 2.5X, 3.5X). It can be used under insufficient light, and the angle of the lens is adjustable.

Item	Order #	Description	12+	6+	1+
A	29-4811	Clamp LED Magnifier and 3 Lenses	\$19.81	\$20.97	\$23.30
B	29-4812	Frame LED Magnifier and 3 Lenses	\$22.48	\$23.81	\$26.45



OPTICAID® CLIP-ON MAGNIFIER

Easily clips onto any eyeglass frame. Provides hands-free magnification of small details without any distortion. Lenses are made of plastic and are optically designed. Sold with carrying case.

Order #	Lens #	Focal Distance	Power	12+	6+	1+
29-7700	#3	14"	1¼X	\$21.68	\$22.95	\$25.50
29-7701	#5	8"	2¼X	\$21.68	\$22.95	\$25.50
29-7702	#7	6"	2¾X	\$21.68	\$22.95	\$25.50
29-7703	#10	4"	2¾X	\$21.68	\$22.95	\$25.50
29-7704	#2	20"	1½X	\$21.68	\$22.95	\$25.50
29-7705	#4	10"	2X	\$21.68	\$22.95	\$25.50



CLIP-ON BINOCULAR MAGNIFIER

Excellent for small tasks that require hands-free work. Can be used with the comfortable binocular frame or can be clipped onto most eyeglass frames.
 - Dual lens system designed to reduce eye strain by convergence on focal point.
 - Easily flips up for normal viewing and down when magnification is required.

Order #	Lens #	Focal Distance	Power	12+	6+	1+
29-4725	#3	14"	1¼X	\$26.86	\$28.44	\$31.60
29-4726	#4	10"	2X	\$26.86	\$28.44	\$31.60
29-4727	#5	8"	2½X	\$26.86	\$28.44	\$31.60
29-4728	#7	6"	2¾X	\$26.86	\$28.44	\$31.60



HALF-FRAME TELESIGHT MAGNIFIER

High-quality prismatic lens in lightweight, half eyeglass frames. Used by those who do not wear glasses. Half-frames stay in place, and lenses lower for magnification and flip up when finished.

Order #	Lens #	Focal Distance	Power	12+	6+	1+
29-7600	#43	14"	1¼X	\$33.11	\$35.06	\$38.95
29-7601	#44	11"	2X	\$33.11	\$35.06	\$38.95
29-7602	#45	9"	2¼X	\$33.11	\$35.06	\$38.95
29-7603	#46	7"	2½X	\$33.11	\$35.06	\$38.95

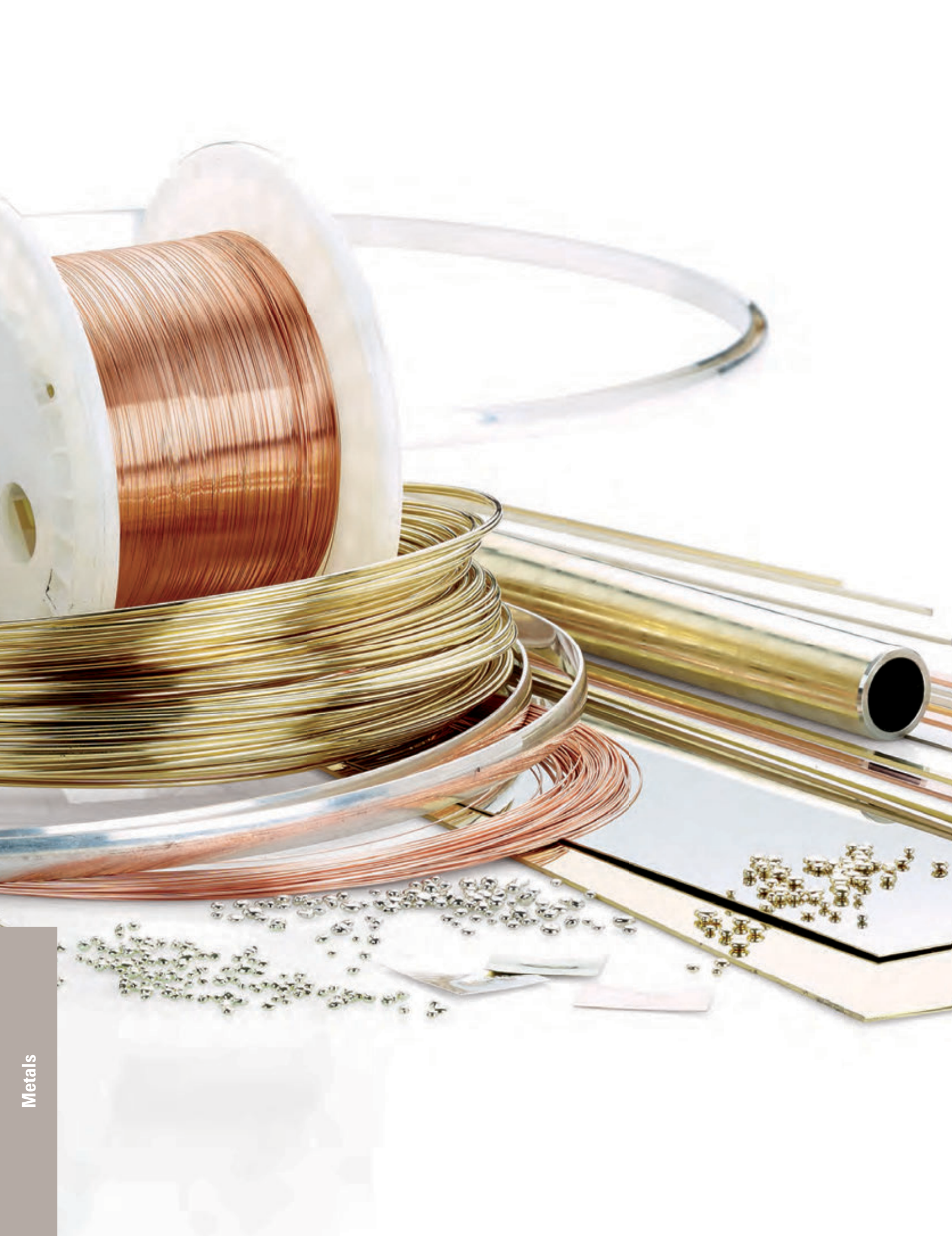

Fabricated Metals

338	Casting Grain
341	Master Alloy
343	Sheet
346	Round Wire
348	Laser Wire/Speed Wire
350	Preform Sizing Stock
351	Sizing Stock
356	Tubing
359	Pattern Wire
360	Solder
366	Stampings





Refined Karats

Refined Karats symbolizes our ongoing environmental consciousness in manufacturing and our promise to act responsibly in all areas of business and production, including water, waste, and energy management. Because of Stuller's compliance with Scientific Certification Systems' (SCS) strict environmental, social, and supply-chain management requirements, our certification allows you to add "earth-friendly" to the characteristics of the products you offer your customers.

As proof of our commitment to sustainability, Stuller earned recycled content certification in an SCS audit. SCS is a global leader in verification of environmental and sustainability claims with internationally recognized standards, and their certification ensures that all of Stuller's manufactured gold and silver product is certified 100% recycled content.

Stuller's SCS certification is just one part of our company's in-house green initiative, Refined Karats. So whenever you see the Refined Karats logo, you can be assured that product contains 100% recycled precious metal content.

100% Recycled



Gold and other precious metals should be mined and refined in a sustainable and responsible manner that respects both the needs of humanity and our environment.



Our position on responsible mining procedures goes much further than the gold mining process itself. It encompasses all aspects of gold: appropriate mining methods on conservation, remediation and fair labor practices. It also includes proper refining; correct handling of aqua regia acid, scrubbing fumes and clean emissions.

Only specific, branded gold bars or grain are acceptable in our production operations and up to 100% of raw materials used in production are recycled internally.

We require that our vendors maintain policies and procedures, which mandate social and environmental responsibility for both themselves and their suppliers.

The European Nickel Directive

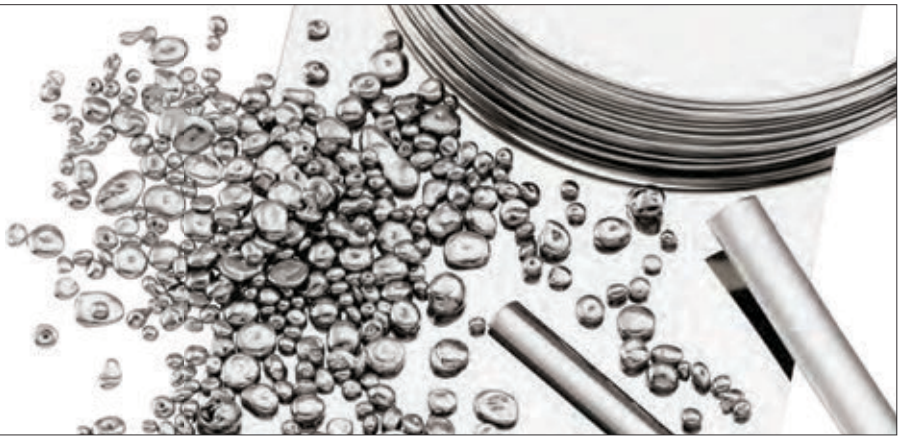

How do changes affect you?

The latest revision of the European Nickel Directive is meant to address the concerns raised from the 2004 version. More stable artificial sweat solutions are used, which are likely more aggressive. The new requirements are outlined in the table below.

Jewelry Type	Ni release value $\mu\text{g}/\text{week}/\text{cm}^2$	Result
Intimate contact with skin	< 0.11	Compliant
	0.11 – 0.35	Non-conclusive
	> 0.35	Non-compliant
Direct and prolonged contact with skin	< 0.28	Compliant
	0.28 – 0.88	Non-conclusive
	> 0.88	Non-compliant

This new law went into effect on April 2013. The results now include an uncertainty factor where it is considered “non-conclusive.” This still puts the burden on the manufacturer to prove it is compliant.

Note: The acceptable nickel release rates are much lower than in earlier standards.

History of the European Directive

Based on the pioneering work on allergy to nickel in 1991 by Dr. Carola Linden, a Swedish dermatologist, the first European Nickel Directive became a law and came into force in June 1994 in all the European Community Countries. The supporting test method on nickel release became a Standard (EN 1811), which

outlines the requirements of the Directive and pass the nickel release test conducted on jewelry products. The test measures the leaching rate of nickel when the jewelry article is immersed in an artificial sweat solution.

The 1994 European Directive established two basic nickel requirements for jewelry alloys:

- It practically excludes the use of nickel in the alloys that come in intimate contact with parts of human body by restricting the nickel content to be less than 0.05% by weight. Earring posts, ear wire assemblies and other body piercing jewelry articles fall under this restriction.
- For jewelry articles that come into direct and prolonged contact with the skin, the test result should show the nickel release rate to be less than 0.5 microgram per square centimeter per week ($0.5 \mu\text{g}/\text{week}/\text{cm}^2$). There is no restriction on the nickel content in the alloy used to make the jewelry articles.

Previous Revision of European Directive

The practical exclusion of nickel and numerous discrepancies of testing instances brought about the first revision of the Directive in 2004 which dealt now only with nickel release rates and removed the restriction on the nickel content.

In spite of these improvements, the nickel release limits imposed by revisions of the standard have proved to be insufficient to avoid reactions in sensitized subjects. In addition, tests revealed that the artificial sweat degraded over the course of a week’s testing which made the nickel release result to be suspect.

We Are Your Prime Manufacturing Source

With one of the largest mill product offerings in the industry, we have what you need. Our prime manufacturing provides more than 50 grain options and at least 20 different mill products.



Get it all from Stuller:

- Master Alloys
- Grain
- Sheet
- Wire
- Laser Wire
- Tubing
- Sizing Stock – Preform™, flat, half-round, triangle, comfort-fit, and square
- Solder – including Color Match™
- Ring Tubing
- Ring Blanks
- Stampings
- Bezel Stock

Order through the website at stuller.com, or by calling 800-877-7777.

Metals Club



GET THE BEST PRICE POSSIBLE ON YOUR METALS PURCHASES AND START SAVING TODAY

How does the Metals Club work?

You tell us how much gold, platinum, or silver products you purchase per month (including grain, sheet, wire, stock, solder, tubing, etc.). Stuller will use this information to set up your Club Membership Level. You will receive your quantity pricing on each and every order, even the smaller ones. This allows you to purchase small quantities as needed, yet receive your total quantity price. Also, as long as you meet the quota for one metal quality, you get the quantity pricing for gold, platinum, and silver products! After a period of time (usually six months), Stuller will review your metals purchases, advise on how closely you have met your original purchasing estimates, and determine if a change in your Club Level would benefit you.

What are my Metals Club level options from which I can choose?

There are eight levels in which to choose from

- 20 dwt
- 50 dwt
- 100 dwt
- 200 dwt
- 500 dwt
- 1000 dwt
- 1500 dwt
- 2000 dwt

How do I join?

Call the Stuller Metals Club Member Hotline toll free at 877-619-2173 or email clubinfo@stuller.com. One of our friendly Club specialists will walk you through the set-up process and answer any questions concerning the Metals Club price program. Remember, if you are not a Club member, you may be paying too much! For more information visit Stuller.com/MetalsClub.

STULLER
METALS CLUB

Call 877-619-2173 to join the Metals Club and start saving today.



You've come to trust Stuller when purchasing mill products, findings, grain, castings, jewelry, diamonds, and thousands of other products. Discover today how you can earn cash or credits toward your Stuller account by sending us your scrap metals.

Choose your preference:

1. **Stuller account credit**
2. **50/50: Stuller account credit / electronic payment or check**
3. **Electronic payment or check**

How does the scrap metal program work?

When your shipment arrives, we weigh it and verify the integrity of the metal. Next, we will melt your clean scrap and fire assay a sample. Then we apply value to your pure precious metal content based on your chosen payment option. All settlements will be based on after-melt weight at second London Fix on day of settlement.

See chart below to find melt value based on precious metal weight received. Scrap weighing **more** than 100 pennyweights will be processed by fire assay, and scrap weighting **less** than 100 pennyweights will be processed by x-ray fluorescence (XRF), unless otherwise noted on packing slip.

Settlement value will be applied to your Stuller account upon your approval.

A packing slip must accompany your precious metal scrap to assure proper payment. Packing slip available online, **Stuller.com/CleanScrap** or contact your friendly Stuller sales associate.

Metal Requirements:

- Send only clean karat gold, silver, platinum or palladium scrap with stones removed
- Fill out our Clean Scrap Packing Slip and include the weight of scrap and identify quality
Remove anything that is not precious metal
- Package, insure adequately, and ship your scrap metal to:
Stuller, Inc.
ATTN Materials Management - 3616
302 Rue Louis XIV
Lafayette, LA 70508

QUALITY	OPTION 1 ACCOUNT CREDIT			OPTION 2 50/50			OPTION 3 ELECTRONIC PAYMENT/CHECK			LAB RESULTS	PAYOUT
	ACCOUNTABILITY	PROCESSING FEE FA XRF		ACCOUNTABILITY	PROCESSING FEE FA XRF		ACCOUNTABILITY	PROCESSING FEE FA XRF			
Gold (Au)	98%	—	—	97%	\$50	\$25	95%	\$50	\$25	3 working days	5 working days
Silver (Ag)	94%	—	—	92%	\$50	\$25	90%	\$50	\$25	3 working days	5 working days
Platinum (Pt)	90%	\$100	N/A	87%	\$100	N/A	85%	\$100	N/A	7 working days	9 working days
Palladium (Pd)	85%	\$100	N/A	82%	\$100	N/A	80%	\$100	N/A	7 working days	9 working days
HIGH-GRADE BENCH FILINGS/GRINDING											
Gold & Silver	97%	\$100	N/A	95%	\$100	N/A	94%	\$100	N/A	7 working days	9 working days
Platinum & Palladium	80%	\$100	N/A	80%	\$100	N/A	80%	\$100	N/A	7 working days	9 working days

High-Grade Bench Filings/Grindings have a 10 ounce minimum (gross weight). Crucibles, emery paper, buffs or saw blades, computer parts, electronic parts, electrical parts, and plating solutions are not accepted for clean scrap (DO NOT SEND THESE ITEMS). Past due balances will be paid first before any funds are transferred to customer's bank.

We understand that you have concerns about the environmental and cultural impacts due to certain mining activities. We assure you that we are just as concerned as you are. We are committed to being true to you, our customer. To do so, we have always believed that this starts with our practices toward our environment and continues to follow through to our business applications. While others have just begun this journey, ours has been a way of life from the start.

We applaud your efforts to recycle your scrap metals. You are doing your part to lessen the impact on the environment. For more information visit **Stuller.com/CleanScrap**.

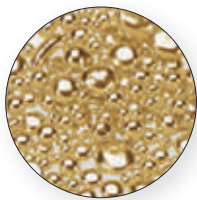

10K
Popular Medium Yellow Color
Standard Yellow #0143

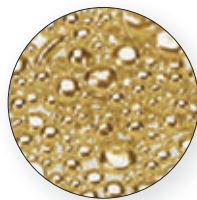

10K
Our Original Bright Yellow
Bright Yellow #0172

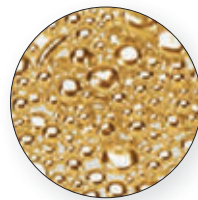

14K
Standard Medium Yellow
Standard Yellow #0143

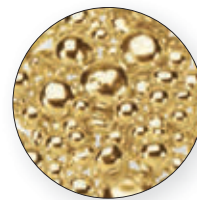

14K
Bright Color Highlights Diamonds
Bright Yellow #0172

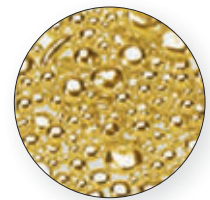

14K
Rich Green Yellow Color
Euro Yellow #0147

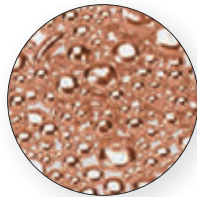

10K
Rose/Pink Gold in Color
Red #0804

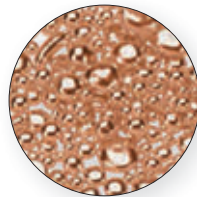

14K
Rose/Pink Gold in Color
Red #0804

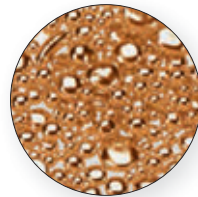

18K
Rose/Pink Gold in Color
Red #0806

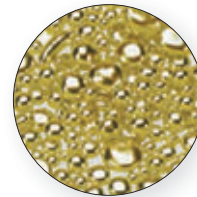

14K
Medium Green Color
Unique Green #0805

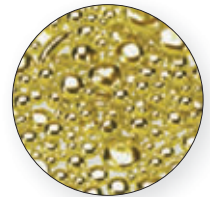

18K
Rich Green Color
Unique Green #0800

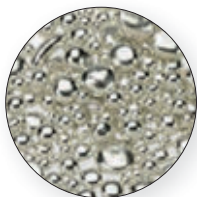

18K
Low Nickel-Off White Color
Soft White #0223

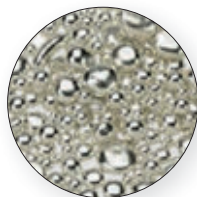

18K
Good Nickel White Color
White #0202



18K X1
Grade 1 Bright White
White #0232

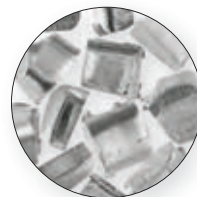

.950/.05 Platinum/Cobalt
Best Color and Castability
White #0907

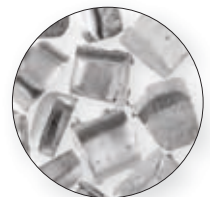

.900/.10 Platinum/Iridium
Good Casting Characteristics
White #0904

Quality Metals

Using our 40+ years of in-depth metals knowledge, we are constantly working to provide you with more value for your money. As your source for metals, quality starts with us.

Our casting grain is produced using raw metals that are certified to exceed 0.999+ in purity. We analyze every melt by traditional fire assay and X-ray fluorescence techniques to ensure quality and consistency.

Choose from 30 different metal quality and color combinations. All are available with low minimums.

Certified by SCS

At Stuller, we are your prime source for fabricated metals. You are buying straight from the manufacturer. We make it. We test it. We use it. So, you can buy with confidence, knowing you are getting the best value.

In addition, we are environmentally mindful in all of our manufacturing processes. Our gold and silver metals have been audited and certified by SCS Global Services* to be 100% recycled content.

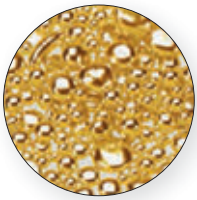

18K
Classic 18kt Yellow Color
Rich Yellow #0112

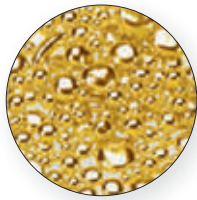

18K
Rich Italian Green Tint;
Popular in Europe
Royal Yellow #0115

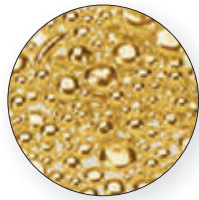

18K
Rich Green Yellow Color
Euro Yellow #0148



22K
Deep Yellow Color
Yellow #0116

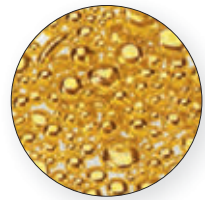

24K
.9995+ Pure Gold
Yellow #0000

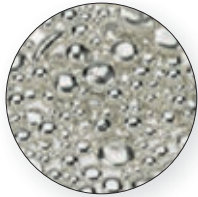

10K X1
Grade 1 Bright White
White #0234

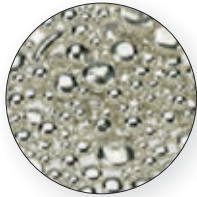

14K
Our Original 14kt White
Standard White #0200



14K
Bright Nickel White Color
Bright White #0225



14K X1
Exceptional Grade 1
White color, White #0233

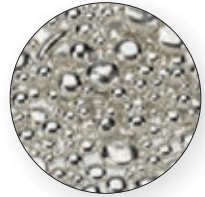

14K PW
High Palladium, Grade 1
White Color .585
Palladium White #0228

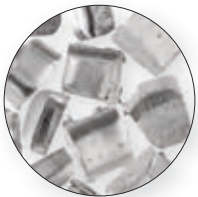

.950/.05 Platinum/Ruthenium
0.95 Platinum
White #0908



.950 Super Palladium
Enhanced 0.95 Palladium Alloy
Super White #0937

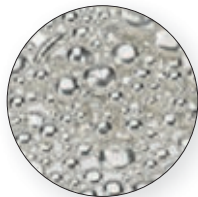

Sterling Silver
White
Standard White #0906

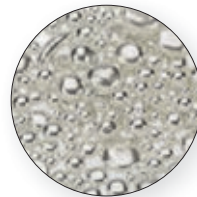

Sterlium Plus
White
Bright White #914

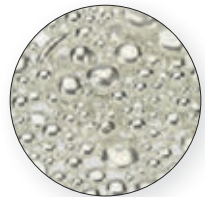

Continuum® Sterling Silver
White
Extreme White #0941

Stuller karat gold casting grains are produced using only high purity raw materials. All metals used in Stuller alloys are certified to exceed 0.999+ in metallic purity. Each melt is analyzed by traditional fire assay and x-ray fluorescence techniques to ensure quality and consistency. Our karat gold casting alloys contain special additives that enhance casting characteristics, provide for less rejects and finishing work, and increase reusability factors. Grain for rolling is formulated specifically for sheet production and wire drawing applications. Our white gold alloys include 10kt, 14kt, 18kt and X1[®] white gold casting grain, which provide an exceptional white color and finish. Our 14kt clean-cast white is enhanced with elements to control grain structure and provide for clean, bright white castings and excellent surface finish. Platinum group metal casting alloys include .585 platinum (formulated with 100% platinum group metals) and .950 super palladium.

Stuller offers one of the most comprehensive selections of white precious metals for jewelry.

Minimum order for grain is 1 pennyweight.

1. To determine the amount of metal needed for casting, multiply the wax weight (including sprue) by the corresponding density (specific gravity). Allow extra for button.
2. Optimal flask temperature will vary according to tree size and type of equipment used.

Note: 14K euro-yellow, 14K, 14K X1, 14K palladium white, and all 18K casting grains meet the European specifications for all gold fineness.



Quality	Description	Nominal Composition %				
		Copper	Silver	Zinc	Nickel	Palladium
10K Standard Yellow	Popular medium yellow color	44.3%	7%	6.9%	–	–
10K Bright Yellow	Our original bright yellow	40.5%	11.2%	6.6%	–	–
10K Rich Yellow	Exceptional yellow luster	41.9%	9.8%	6.5%	–	–
10K Yellow	Sheet/wire fabrication	39.8%	9.4%	9.4%	–	–
10K Red	Rose/pink gold in color	55%	3%	0.5%	–	–
14K Euro Yellow	Rich green /yellow .585	22.7%	11.4%	7.6%	–	–
14K Standard Yellow	Standard medium yellow	31.6%	5%	1.9%	–	–
14K Clean Cast Yellow	Grain refined; deoxidized	28.50%	6.70%	6.70%	–	–
14K Yellow	Bright color highlights diamonds	29%	8%	4.7%	–	–
14K Rich Yellow	Premium yellow luster	28%	9.8%	3.8%	–	–
14K Lemon Yellow	Light/pale yellow color	25%	8.6%	8%	–	–
14K Yellow	Sheet/wire fabrication	28.4%	6.7%	6.7%	–	–
14K Red	Rose/pink gold in color	39.2%	2%	0.4%	–	–
14K Green	Medium green color	2%	39%	0.6%	–	–
18K Rich Yellow	Classic 18kt yellow color	11.3%	12.5%	0.8%	–	–
18K Royal Yellow	Rich Italian green tint; popular in Europe	6.7%	16.5%	1.5%	–	–
18K Yellow	Sheet/wire fabrication	9.3%	15%	0.6%	–	–
18K Euro Yellow	Rich green yellow color	5.9%	18.2%	0.6%	–	–
18K Red	Rose/pink gold in color	23.30%	1.20%	0.20%	–	–
18K Green	Rich green color	1.2%	23.2%	0.4%	–	–
22K Yellow	Deep yellow color	3.5%	4.9%	–	–	–
24K Yellow	.9995+ pure gold	–	–	–	–	–
10K White	Standard nickel white	35.7%	–	12.3%	10.3%	–
10K White	Sheet/wire fabrication	33.8%	–	9%	16%	–
10K X1[®] White	Grade 1 bright white	33.2%	–	9%	16%	–
14K Soft Nickel White	Low nickel-off white color	25.5%	–	8.8%	7.5%	–
14K Standard White	Our original 14kt white	23.80%	–	8.8%	9%	–
14K Bright White	Bright nickel white color	21%	–	7.84%	12.73%	–
14K X1[®] White	Exceptional grade 1 white color	17.5%	–	8.95%	15%	–
14K Clean Cast White	Grain refined; deoxidized	21.5%	–	9%	11%	–
14K White	Low palladium-off white color	4.6%	26.3%	0.5%	–	10.4%
14K White	High palladium, grade 1 white color .585	7.2%	20%	0.75%	–	13.5%
14K White	Sheet/wire fabrication	24.2%	–	6.4%	11.1%	–
18K Soft White	Low nickel-off white color	13.1%	–	5%	6.2%	–
18K X1[®] White	Grade 1 bright white color	8.75%	–	4.1%	12%	–
18K White	Palladium, excellent cast ability, good color	8.3%	–	–	–	13%
18K White	Good nickel white color	11.4%	–	2%	11.4%	–
0.585 Platinum	100% PGM alloy	–	–	–	–	–
.900/.10 Platinum/Iridium	Good casting characteristics	–	–	–	–	–
.950/.05 Platinum/Cobalt	Best color and castability	–	–	–	–	–
.950/.05 Platinum/Ruthenium	95% platinum	–	–	–	–	–
.950 Super Palladium	Enhanced 95% palladium alloy	–	–	–	–	95%

LEAD TIMES: 10K yellow, 14K yellow, 14K white, 18K yellow and sterling silver will ship same day in most cases. Back orders will ship the following day. All other metal qualities are MTO (made to order) and will ship within three working days in most cases. Same-day shipping subject to order specifications, special request, and inventory on hand at time of order. Additional charges and lead times may apply to odd quantities.



100% Recycled Gold and Silver. Visit Stuller.com/SensibleSourcing for more information.



Quality	Master Alloy Used	Density ¹ gm/cm ³	Vickers Hardness	Melting Temp Range °F	Casting Temp Range °F	Flask ³ Temp °F	1 dwt	50 dwt
10K Standard Yellow	—	11.32	128	1525-1645° F	1770-1855° F	850-950° F	\$33.10	\$31.64
10K Bright Yellow	CA03	11.47	135	1480-1610° F	1735-1820° F	900-1000° F	\$33.10	\$31.64
10K Rich Yellow	—	11.42	131	1490-1615° F	1740-1825° F	850-950° F	\$33.10	\$31.64
10K Yellow	RA03	11.37	131	1505-1605° F	1730-1815° F	850-950° F	\$33.10	\$31.64
10K Red	CA15	11.52	122	1740-1780° F	1905-1990° F	950-1050° F	\$35.04	\$33.58
14K Euro Yellow	—	12.91	134	1520-1615° F	1740-1825° F	900-1000° F	\$43.92	\$42.46
14K Standard Yellow	—	12.84	138	1545-1600° F	1725-1810° F	950-1100° F	\$43.92	\$42.46
14K Clean Cast Yellow	—	12.89	155	1510-1590° F	1715-1800° F	950-1100° F	\$43.92	\$42.46
14K Yellow	CA03	12.99	162	1480-1580° F	1705-1790° F	900-1000° F	\$43.92	\$42.46
14K Rich Yellow	—	13.05	165	1450-1535° F	1660-1745° F	900-1000° F	\$43.92	\$42.46
14K Lemon Yellow	CA04	12.84	138	1545-1600° F	1725-1810° F	850-950° F	\$43.92	\$42.46
14K Yellow	RA03	12.89	136	1675-1720° F	1845-1930° F	950-1050° F	\$43.92	\$42.46
14K Red	CA15	13.03	88	1710-1800° F	1925-2010° F	900-1000° F	\$45.88	\$44.41
14K Green	CA16	13.9	145	1410-1495° F	1620-1705° F	900-1000° F	\$46.13	\$44.67
18K Rich Yellow	CA21	15.39	160	1585-1630° F	1755-1840° F	900-1050° F	\$54.96	\$53.50
18K Royal Yellow	CA23	15.53	126	1615-1655° F	1780-1865° F	900-1050° F	\$54.96	\$53.50
18K Yellow	RA08	15.54	141	1620-1665° F	1790-1875° F	900-1050° F	\$54.96	\$53.50
18K Euro Yellow	—	15.64	115	1645-1720° F	1845-1930° F	900-1050° F	\$54.96	\$53.50
18K Red	CA15	15.02	257	1670-1685° F	1810-1895° F	950-1050° F	\$56.86	\$55.40
18K Green	CA16	15.89	95	1800-1860° F	1985-2070° F	950-1050° F	\$57.03	\$55.57
22K Yellow	—	17.86	74	1810-1845° F	1970-2055° F	1000-1100° F	\$65.57	\$64.11
24K Yellow	—	19.3	30	1945° F	2070-2155° F	1000-1100° F	\$67.92	\$67.19
10K White	CA06	10.99	165	1715-1750° F	1875-1960° F	1000-1100° F	\$33.02	\$31.55
10K White	RA13	11.17	178	1780-1850° F	1975-2060° F	1000-1100° F	\$33.02	\$31.55
10K X1® White	—	11.17	158	1754-1850° F	2000-2075° F	1000-1100° F	\$33.27	\$31.80
14K Soft Nickel White	CA06	12.53	172	1655-1710° F	1835-1920° F	1000-1100° F	\$43.86	\$42.40
14K Standard White	CA02	12.57	179	1670-1710° F	1835-1920° F	1000-1100° F	\$43.86	\$42.40
14K Bright White	—	12.61	204	1715-1740° F	1865-1950° F	1000-1100° F	\$43.86	\$42.40
14K X1® White	—	12.58	204	1682-1730° F	1880-1955° F	1000-1100° F	\$44.21	\$42.74
14K Clean Cast White	—	12.57	174	1676-1719° F	1875-1990° F	1000-1100° F	\$43.86	\$42.40
14K White	CA17	14.37	125	1865-1920° F	2045-2130° F	1050-1200° F	\$48.79	\$47.33
14K White	—	14.60	150	2030-2165° F	2280-2380° F	1050-1200° F	\$50.27	\$48.81
14K White	RA13	12.71	183	1710-1760° F	1885-1970° F	950-1100° F	\$43.86	\$42.40
18K Soft White	—	14.62	203	1625-1665° F	1790-1875° F	950-1100° F	\$54.82	\$53.36
18K X1® White	—	14.69	231	1662-1925° F	1852-1925° F	950-1100° F	\$55.07	\$53.61
18K White	—	15.66	158	1895-2040° F	2155-2255° F	1000-1150° F	\$61.62	\$60.16
18K White	CA18/RA18	14.86	226	1725-1740° F	1810-1895° F	950-1100° F	\$54.82	\$53.36
.585 Platinum	—	17.27	145	3140-3180° F	3275-3450° F	1350-1500° F	\$79.64	\$78.10
.900/10 Platinum/Iridium	—	21.56	110	3236-3254° F	3360-3400° F	1500-1650° F	\$71.01	\$69.48
.950/05 Platinum/Cobalt	—	20.1	135	3015-3050° F	3200-3250° F	1400-1550° F	\$76.14	\$74.60
.950/05 Platinum/Ruthenium	—	20.66	130	3266-3295° F	3360-3400° F	1500-1650° F	\$76.46	\$74.93
.950 Super Palladium	—	12.40	114	2732-2768° F	2875-3000° F	1300-1500° F	\$49.27	\$47.73

See page 336 for all qualities available.

YELLOW 10K 14K 18K		RED 10K 14K 18K		WHITE 10K 14K 14X1 18K		GREEN 10K 14K 18K		.950 PLATINUM COBALT		STERILUM PLUS	
------------------------------------	--	---------------------------------	--	---	--	-----------------------------------	--	-----------------------------	--	----------------------	--

STULLER METALS CLUB

Call **877-619-2173** to join the Metals Club and start saving today.



Sterling Silver

Melting Temperature Range: 1590-1660°F Specific Gravity: 10.36
 Our original standard sterling silver casting grain. Contains 92.7% silver and 7.3% copper.
 (FORMERLY #900)



Continuum® Sterling Silver

Melting Temperature Range: 1680-1730°F Specific Gravity: 10.40
 This platinum group sterling is by far the hardest sterling silver ever developed by Stuller®. It has over 95% precious metal content. Continuum® Sterling has a much higher as-cast hardness that allows setting of high quality stones in sterling silver jewelry, and a much tighter grain size allowing a better more lasting finish, superior oxidizing, and tarnish resistance benefits.



Sterling 935

Melting Temperature Range: 1650-1750°F Specific Gravity: 10.23
 Contains 93.5% silver instead of the traditional 92.5% in most other sterling silver casting grains. The additional silver content provides a white luster similar to pure silver, while maintaining the hardness and durability of standard sterling silver. Used by major manufacturers to enhance their silver product lines.



Sterling 935 Deox

Melting Temperature Range: 1435-1610°F Specific Gravity: 10.23
 Formulated to eliminate firescale and reduce porosity, while maintaining the hardness and durability of standard sterling silver. 93.5% silver content provides a richer silver luster as compared with standard sterling. Several times more tarnish resistant than standard sterling. May be reused with 50% fresh mix. Recommended casting temperature: 1800-1825 ° F.



Fine Silver

Melting Temperature Range: 1761-1860°F Specific Gravity: 10.5
 .9995 + pure silver.



Sterlium Plus

Melting Temperature Range: 1585-1655°F Specific Gravity: 10.25
 A superior deoxidized sterling silver designed to achieve maximum hardness and eliminate firescale and porosity. Developed to have a hardness approximately equal to standard sterling silver. Ultra white color. An all purpose application. Alloy extremely user friendly as it is easy to work with for casting as well as fabrication for rolling. *Stuller® now offers all manufactured silver mill product in Sterlium Plus.*

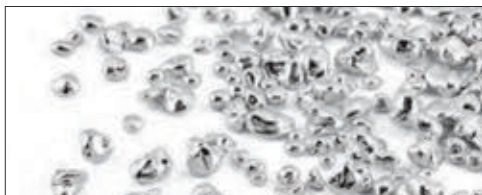

Super Sterling

Melting Temperature Range: 1555-1645°F Specific Gravity: 10.37
 Deoxidized sterling silver that is rather resistant to tarnishing. This alloy is softer than standard sterling silver and casts very well. Designed to reduce firescale and porosity. Best used for investment jewelry casting.

Minimum order for silver casting grain is 10 pennyweights.

LEAD TIMES: 10K yellow, 14K yellow, 14K white, 18K yellow and sterling silver will ship same day in most cases. Back orders will ship the following day. All other metal qualities are MTO (made to order) and will ship within three working days in most cases. Same-day shipping subject to order specifications, special request, and inventory on hand at time of order. Additional charges and lead times may apply to odd quantities.

CASTING ALLOY

Used For	Item	Color	Silver Content	Melting Point °F			10 dwt
				10K	14K	18K	
10kt/14kt Yellow	CA03	Bright Yellow	13%	1617° F	1610° F	–	\$0.53
10kt/14kt Yellow	CA04	Lemon Yellow	20.8%	1530° F	1535° F	–	\$0.55
10kt/14kt Yellow	CA08	Deep Yellow	12%	1590° F	1580° F	–	\$0.47
10kt/14kt Yellow	CA09	Yellow	13.2%	1580° F	1575° F	–	\$0.48
10kt/14kt Yellow	CA10	Reddish Yellow	14.8%	1646° F	1606° F	–	\$0.49
10kt/14kt Yellow	CA11	Rich Yellow	17.25%	1610° F	1620° F	–	\$0.51
10kt/14kt Yellow	CA12	Bright Yellow	19.75%	1560° F	1550° F	–	\$0.54
10kt/14kt Yellow	CA13	Rich Lemon Yellow	27.5%	1620° F	1610° F	–	\$0.61
10kt/14kt Yellow	CA14	Rich Yellow	33.33%	1580° F	1560° F	–	\$0.66
10kt/14kt Red	CA15	Red	5%	1780° F	1720° F	–	\$0.40
18kt Yellow	CA05	Bright Yellow	60%	–	–	1705° F	\$0.90
18kt Yellow	CA20	Reddish Yellow	38.25%	–	–	1660° F	\$0.70
18kt Yellow	CA21	Rich Yellow	50.5%	–	–	1630° F	\$0.81
18kt Yellow	CA23	Royal Yellow	66.4%	–	–	1755° F	\$0.96
18kt/22kt Yellow	CA24	Deep Yellow	58%	–	–	1835° F	\$0.88
10kt/14kt Standard White	CA02	Standard White	–	1840° F	1710° F	–	\$0.36
10kt/14kt White	CA06	Soft Nickel White	–	1710° F	1734° F	–	\$0.36
14kt White	X1	Extreme White	39.6%	–	2250° F	–	\$0.46
14kt White	CA17	Palladium White	63%	–	1920° F	–	\$12.18
14kt/18kt Green	CA16	Green	93.6%	–	1800° F	1860° F	\$1.20
18kt White	CA18	Nickel White	40%	–	–	1685° F	\$0.36
18kt palladium white	CA19/ RA18	Palladium White	2%	–	–	2040° F	\$26.75

Stuller master alloys are produced with only the purest metals available. Our master alloys for casting grain are formulated to produce brighter castings, with reduced porosity and uniform grain structure and are non-oxidizing. Master alloys for rolling are specifically formulated for rolling and wire drawing applications. Casting and rolling alloys do not contain gold.



Minimum order for master alloy casting grain is 10 pennyweights.

ROLLING ALLOY

Used For	Item	Color	Silver Content	Melting Point °F			10 dwt
				10K	14K	18K	
10kt/14kt Yellow	RA03	Rich Yellow	16%	1605° F	1600° F	–	\$0.50
10kt/14kt Yellow	RA05	Yellow	9.2%	1600° F	1580° F	–	\$0.44
10kt/14kt Yellow	RA11	Deep Yellow	11.8%	1550° F	1540° F	–	\$0.46
10kt/14kt Yellow	RA14	Bright Yellow	20%	1635° F	1625° F	–	\$0.54
10kt/14kt Yellow	RA16	Rich Yellow	33.33%	1580° F	1560° F	–	\$0.66
10kt/14kt Red	RA09	Red	5%	1776° F	1707° F	–	\$0.41
18kt/22kt Yellow	RA06	Deep Yellow	58%	–	–	1835° F	\$0.88
18kt Yellow	RA08	Bright Yellow	60%	–	–	1665° F	\$0.90
18kt Yellow	RA15	Royal Yellow	66.4%	–	–	1765° F	\$0.96
10kt/14kt White	RA13	Nickel White	–	1850° F	1760° F	–	\$0.36
10kt/14kt White	RA02	Soft Nickel White	–	1860° F	1810° F	–	\$0.36
14kt White	RA17	Palladium White	63%	–	1920° F	–	\$12.18
14kt/18kt Green	RA10	Green	93.6%	–	1757° F	–	\$1.20
18kt White	RA12	Nickel White	–	–	–	1685° F	\$0.36

Minimum order for master alloy rolling grain is 10 pennyweights.

See page 336 for all qualities available.	YELLOW	RED	WHITE	GREEN	.950 PLATINUM COBALT	STERLIUM PLUS
	10K 14K 18K	10K 14K 18K	10K 14K 14X1 18K	10K 14K 18K		

STULLER METALS CLUB

Call 877-619-2173 to join the Metals Club and start saving today.



BASE METALS FOR CASTING

Order # 54-4409

ALLOY 99 REPLENISHER

Designed to deoxidize used gold for casting.

10kt Scrap: Add 5 dwt #99 and 3.57 dwt of fine gold for each 100 dwt of 10kt scrap being melted.

14kt Scrap: Add 4 dwt #99 and 5.60 dwt of fine gold for each 100 dwt of 14kt scrap being melted.

18kt Scrap: Add 2 dwt #99 and 6.00 dwt of fine gold for each 100 dwt of 18kt scrap being melted.

For white gold, the above ratios can be applied, but use will be limited to once or twice due to the yellowing of the white color.

2 troy ounce bag \$12.10



Order # 54-8100

HERCULOY CASTING CUBES

An economical bronze alloy containing 5% zinc. The low zinc content releases little fumes or smoke when melted. Color approximates 14kt yellow gold. Readily accepts nickel, gold, or rhodium plating, and solders easily with silver solder. Sold by the pound. Melting point 1850°F. Metal to wax ratio 8:1.

\$21.20



Order # 54-8102

ART BRASS CASTING CUBES

An economical brass alloy containing 30% zinc. The low casting temperature and bright yellow color lend itself to jewelry casting. Polishes bright and electroplates/solders beautifully. Overheating can create excessive fumes and smoke. Sold by the pound. Melting point 1700°F. Metal to wax ratio 9:1.

\$21.20



Order # 54-8104

J S BRASS CASTING GRAIN

A high-quality brass casting alloy containing the same deoxidizing agents used in our karat gold casting grain. Castings are bright and firescale free. Color is very close to 14kt yellow. Highly recommended for sculpture. Sold by the pound. Melting point 1950°F. Metal to wax ratio 9:1.

\$23.40



Order # 54-8106

SILICON BRONZE CASTING GRAIN

Our silicon bronze's casting properties are superior to most other bronzes. Cast with few fumes or smoke and can readily be electroplated. Color is darker than our brass and Herculoy formulas. Highly recommended for sculpture. Sold by the pound. Melting point 1850°F. Metal to wax ratio 9:1.

\$21.20



Order # 54-8108

WHITE BRONZE CASTING GRAIN

A nickel-free white bronze alloy with a low casting temperature of 1650°F. Accepts rhodium plating after a nickel or gold pre-plate. Can be brazed and polished. Sold by the pound. Melting point 1850°F. Metal to wax ratio 8:1.

\$21.20

Base metals for casting shipping weights is 1 pound.

SHEET

Karat Gold, Platinum, and Palladium sheets are supplied flat and 3/4 hard temper unless otherwise requested. Additional options are available in our 14X1® white, which has a premium white color.

Profile	Thickness		Approximate Pennyweights (dwt) Per Square Inch					
	Gauge	mm	Inch	10K	14K	18K	Plat/Ru	.950 pd
—	32	0.20mm	.008"	0.92	1.08	1.10	1.75	0.97
—	31	0.23mm	.009"	1.04	1.21	1.40	1.90	1.09
—	30	0.26mm	.010"	1.15	1.34	1.60	2.18	1.22
—	29	0.29mm	.011"	1.27	1.48	1.75	2.39	1.37
—	28	0.32mm	.013"	1.50	1.71	1.95	2.83	1.54
—	27	0.36mm	.014"	1.62	1.93	2.20	3.05	1.73
—	26	0.41mm	.016"	1.94	2.16	2.62	3.49	1.94
—	25	0.46mm	.018"	2.08	2.42	2.85	3.92	2.18
—	24	0.51mm	.020"	2.31	2.69	3.30	4.36	2.45
—	23	0.57mm	.023"	2.65	3.09	3.50	5.01	2.75
—	22	0.64mm	.025"	2.89	3.36	4.16	5.45	3.09
—	21	0.72mm	.028"	3.23	3.87	4.40	6.10	3.47
—	20	0.81mm	.032"	3.69	4.30	5.23	6.98	3.90
—	19	0.91mm	.036"	4.31	4.88	5.70	7.85	4.38
—	18	1.02mm	.040"	4.62	5.48	6.62	8.93	5.27
—	17	1.15mm	.045"	5.19	6.04	7.10	9.81	5.53
—	16	1.29mm	.051"	6.10	6.90	8.36	11.12	6.20
—	15	1.45mm	.057"	6.58	7.66	9.00	12.43	6.97
—	14	1.63mm	.064"	7.39	8.60	10.50	13.96	7.82
—	13	1.83mm	.072"	8.31	9.67	11.40	15.70	8.79
—	12	2.05mm	.081"	9.35	10.88	13.30	17.66	9.86
—	11	2.31mm	.091"	10.50	12.22	14.25	19.84	11.07
—	10	2.59mm	.102"	11.77	13.70	16.70	22.24	12.43
—	9	2.91mm	.114"	13.16	15.31	18.05	24.86	13.96
—	8	3.26mm	.128"	14.78	17.19	19.80	27.91	15.68



- Minimum order is one square inch per size.
- Maximum sheet size is 4x14 for same or next day shipping.

Longer lengths are available with additional lead time. Annealing available upon request.

SHEET (Based on 20 Gauge)	Approximate Pricing Per Pennyweight (dwt)		
	1 dwt	50 dwt	100 dwt
10K Yellow or White	\$33.35	\$31.52	\$31.22
14K Yellow or White	\$44.17	\$42.34	\$42.03
18K Yellow or White	\$55.21	\$53.38	\$53.07
.950/.05 Platinum/Ruthenium	\$77.95	\$76.92	\$76.81
Palladium	\$50.66	\$49.63	\$49.51

LEAD TIMES: 10kt yellow, 14kt yellow, 14kt white, 18kt yellow and sterling silver will ship same day in most cases. Back orders will ship the following day. All other metal qualities are MTO (made to order) and will ship within three working days in most cases. Same-day shipping subject to order specifications, special request, and inventory on hand at time of order. Additional charges and lead times may apply to odd quantities.

See page 336 for all qualities available.	YELLOW	RED	WHITE	GREEN	.950 PLATINUM COBALT	STERLING PLUS
	10K	10K	10K	10K	10K	10K
	14K	14K	14K	14K	14K	14K
	18K	18K	14X1 18K	18K	18K	18K

STULLER METALS CLUB

Call 877-619-2173 to join the Metals Club and start saving today.

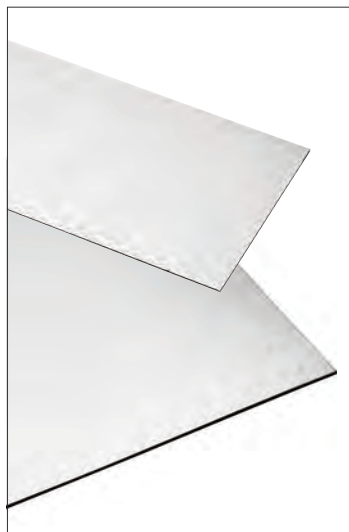

STERLING SILVER

6" Wide Sterling Sheet is available in dead soft temper as well as our original standard temper (medium-hard)/mill finish. One dimension must be 6" when ordering sterling silver sheet. Sterling silver sheet is available in even gauges only. Maximum length is 6" x 36".

Profile	Thickness		Approximate Pennyweights (dwt) Per Size								
	Gauge	mm	Inch	6" x 1"		6" x 3"		6" x 6"		6" x 12"	
				Sterling	Fine	Sterling	Fine	Sterling	Fine	Sterling	Fine
—	30	0.26mm	.010"	6.52	6.63	19.56	19.89	39.12	39.78	78.24	79.56
—	28	0.32mm	.013"	8.22	8.36	24.66	25.08	49.32	50.16	98.64	100.32
—	26	0.41mm	.016"	10.37	10.54	31.11	31.62	62.22	63.24	124.44	126.46
—	24	0.51mm	.020"	13.12	13.33	39.36	39.99	78.72	79.98	157.44	156.96
—	22	0.64mm	.025"	16.51	16.78	49.53	50.34	99.06	100.68	198.12	201.36
—	20	0.81mm	.032"	20.88	21.22	62.64	63.66	125.28	127.32	250.56	254.64
—	18	1.02mm	.040"	26.30	26.74	78.90	80.22	157.80	160.44	315.60	320.88
—	16	1.29mm	.051"	33.16	33.71	99.48	101.13	198.96	202.26	397.92	404.52
—	14	1.63mm	.064"	41.82	42.51	125.46	127.53	250.92	255.06	501.84	510.12
—	12	2.05mm	.081"	52.71	—	158.13	—	316.26	—	632.52	—
—	10	2.59mm	.102"	66.48	—	199.44	—	398.88	—	797.76	—
—	8	3.26mm	.128"	83.84	—	251.52	—	503.04	—	1006.08	—

Minimum order for sheet is 6 x 1 inches.

FINE SILVER

.9995 Fine silver sheet is supplied dead soft in 6" widths. Available in even gauges only. One dimension must be 6" when ordering. Maximum length is 6" x 24".

6" SILVER SHEET	Approximate Pricing Per Pennyweight (dwt)/Ounce (oz)					
	1 dwt	1 oz	400 dwt	20 oz	1000 dwt	50 oz
Fine Silver	\$1.25	\$25.00	\$1.19	\$23.80	\$1.17	\$23.40
Sterlium Plus	\$1.40	\$28.00	\$1.34	\$26.80	\$1.32	\$26.40

STERLING SILVER

Sterling silver 12 inch wide sheet is supplied dead soft with brush finish in 16, 18, 20, 22, 24, and 26 gauge. One dimension must be 12 inches when ordering 12 inch wide sterling silver sheet.

Profile	Thickness		dwt/inch	Approximate Pennyweights (dwt) Per Size				
	Gauge	mm		12" x 1"	12" x 6"	12" x 12"	12" x 18"	
—	26	0.41mm	.016"	1.74	20.86	125.17	250.33	375.50
—	24	0.51mm	.020"	2.19	26.31	157.83	315.66	473.49
—	22	0.64mm	.025"	2.76	33.11	198.65	397.31	595.96
—	20	0.81mm	.032"	3.49	41.88	251.27	502.54	753.80
—	18	1.02mm	.040"	4.36	52.32	313.92	627.84	941.76
—	16	1.29mm	.051"	5.54	66.48	398.89	797.77	1196.66

Minimum order for sheet is 12 x 1 inches.

12" SILVER SHEET	Approximate Pricing Per Pennyweight (dwt)/Ounce (oz)					
	1 dwt	1 oz	400 dwt	25 oz	1000 dwt	50 oz
Sterling Silver	\$1.40	\$28.00	\$1.34	\$26.80	\$1.32	\$26.40

LEAD TIMES: 10K yellow, 14K yellow, 14K white, 18K yellow and sterling silver will ship same day in most cases. Back orders will ship the following day. All other metal qualities are MTO (made to order) and will ship within three working days in most cases. Same-day shipping subject to order specifications, special request, and inventory on hand at time of order. Additional charges and lead times may apply to odd quantities.

See page 336 for all qualities available.	YELLOW	RED	WHITE	GREEN	.950 PLATINUM COBALT	STERLIUM PLUS
	10K 14K 18K	10K 14K 18K	10K 14K 14X1 18K	10K 14K 18K	10K 14K 18K	



REFINED KARATS

 100% Recycled Gold and Silver.
 Visit Stuller.com/SensibleSourcing for more information.

YELLOW GOLD-FILLED



10kt 1/10 Single-Sided Sheet. 10% 10kt yellow gold-filled by weight (1⁰/₁₀) mechanically bonded to bronze base metal. Stocked in soft 4" x 30" sheets. One dimension must be 4" when ordering.

Minimum order for sheet is 4 x 1 inches.

Profile	Gauge	Thickness		Approximate Pennyweights (dwt) Per Size			
		mm	Inch	4" x 1"	4" x 3"	4" x 6"	4" x 12"
10kt 1/10 Single-Sided Sheet.							
	16	1.29mm	.050"	18.80	56.40	112.80	225.60
	14	1.63mm	.060"	22.60	67.80	135.60	271.20

14kt 1/20 Single-Sided Sheet. 5% 14kt yellow gold-filled by weight (1⁴/₂₀). Sheet is clad on one side. Great for stampings and jewelry requiring a single-sided, gold-filled surface. Stocked in soft 3" x 30" sheets. One dimension must be 3" when ordering.

Minimum order for sheet is 3 x 1 inches.

Profile	Gauge	Thickness		Approximate Pennyweights (dwt) Per Size			
		mm	Inch	3" x 1"	3" x 3"	3" x 6"	3" x 12"
14kt 1/20 Single-Sided Sheet.							
	22	0.64mm	.025"	7.20	21.60	43.20	86.40
	20	0.81mm	.032"	14.10	42.30	84.60	169.60
14kt 1/40 x 1/40 Double-Sided Sheet.							
	26	0.41mm	.016"	9.21	27.60	55.20	110.50

YELLOW GOLD-FILLED SHEET	Approximate Pricing Per Pennyweight (dwt)/Ounce (oz)					
	1 dwt	1 oz	50 dwt	25 oz	100 dwt	50 oz
1/10 14K Yellow Gold Filled	\$4.30	\$86.00	\$3.84	\$76.80	\$3.69	\$73.80
1/20 14K Yellow Gold Filled	\$3.65	\$73.00	\$3.19	\$63.80	\$3.04	\$60.80
1/40 14K Yellow Gold Filled	\$3.65	\$73.00	\$3.19	\$63.80	\$3.04	\$60.80



14kt 1/40 x 1/40 Double-Sided Sheet. 5% 14kt yellow gold-filled by weight (1⁴/₄₀ x 1⁴/₄₀). Excellent for earrings and other applications requiring double-sided, gold-filled surfaces. Stocked in soft 3" x 30" sheets. One dimension must be 3" when ordering.

Minimum order for sheet is 3 x 1 inches.

GOLD STRIP

Karat gold strip is supplied flat with a 3/4 hard-temper unless otherwise requested. Minimum order varies according to width of strip. Approximate pennyweights per inch (14kt) and corresponding minimum order length are listed below. Karat gold strip is available in lengths up to 14".

Width	Minimum Order Length	14K/Thickness, Approximate Pennyweights (dwt) by Inch						
		15 Gauge 0.057"	17 Gauge 0.045"	20 Gauge 0.032"	24 Gauge 0.020"	26 Gauge 0.016"	28 Gauge 0.013"	30 Gauge 0.010"
24mm	1.5"	7.34	5.79	4.12	2.58	2.06	1.67	1.29
22mm	1.5"	6.73	5.31	3.78	2.36	1.89	1.53	1.18
20mm	1.5"	6.12	4.83	3.43	2.15	1.71	1.40	1.07
18mm	1.5"	5.50	4.35	3.09	1.93	1.55	1.26	0.97
16mm	1.5"	4.89	3.86	2.75	1.71	1.37	1.12	0.86
15mm	2"	4.59	3.62	2.58	1.61	1.29	1.05	0.81
14mm	2"	4.28	3.38	2.40	1.50	1.20	0.98	0.75
13mm	2.5"	3.98	3.14	2.23	1.40	1.11	0.91	0.70
12mm	3"	3.67	2.90	2.06	1.29	1.03	0.84	0.64
11mm	3"	3.36	2.66	1.89	1.18	0.95	0.78	0.59
10mm	3"	3.06	2.41	1.71	1.07	0.86	0.70	0.55
9mm	3"	2.75	2.17	1.55	0.97	0.77	0.69	0.48
8mm	3.5"	2.45	1.93	1.37	0.86	0.69	0.56	0.43
7mm	4"	2.14	1.69	1.20	0.75	0.60	0.49	0.38

GOLD STRIP (based on 20 gauge)	Approximate Pricing Per Pennyweight (dwt)		
	1 dwt	50 dwt	100 dwt
10K Yellow or White	\$55.21	\$53.38	\$53.07
14K Yellow or White	\$33.35	\$31.52	\$31.22
18K Yellow or White	\$44.17	\$42.34	\$42.03



Annealing available upon request. For strips less than 7mm wide, see flat bezel.

Available qualities include 10kt, 14kt, 18kt, and 14kt and 18kt palladium white.

STULLER
METALS CLUB

Call 877-619-2173 to join the Metals Club and start saving today.



ROUND WIRE

Round wire is supplied in continuous coils with a medium-hard temper unless otherwise requested. Other metal qualities include 14kt X1® white and .585 platinum, all of which have a premium white color. Straight wire is also available in numerous options. Annealing is available upon request.

Profile	Thickness			Approximate Pennyweights (dwt) Per Square Inch				
	Gauge	mm	Inch	10K	14K	18K	Plat/Ru	.950 pd
•	30	0.26mm	.010"	0.01	0.01	0.01	0.02	0.01
•	29	0.29mm	.011"	0.01	0.01	0.02	0.02	0.01
•	28	0.32mm	.013"	0.02	0.02	0.02	0.03	0.02
•	27	0.36mm	.014"	0.02	0.02	0.03	0.03	0.02
•	26	0.41mm	.016"	0.03	0.03	0.03	0.04	0.03
•	25	0.46mm	.018"	0.03	0.04	0.04	0.06	0.03
•	24	0.51mm	.020"	0.04	0.04	0.05	0.07	0.04
•	23	0.57mm	.023"	0.05	0.05	0.07	0.09	0.06
•	22	0.64mm	.025"	0.06	0.07	0.08	0.11	0.61
•	21	0.72mm	.028"	0.07	0.08	0.10	0.13	0.08
•	20	0.81mm	.032"	0.10	0.11	0.13	0.18	0.10
•	19	0.91mm	.036"	0.13	0.14	0.17	0.22	0.12
•	18	1.02mm	.040"	0.16	0.17	0.27	0.29	0.16
•	17	1.15mm	.045"	0.21	0.23	0.26	0.35	0.20
•	16	1.29mm	.051"	0.27	0.28	0.33	0.45	0.25
•	15	1.45mm	.057"	0.32	0.35	0.41	0.56	0.31
•	14	1.63mm	.064"	0.38	0.44	0.53	0.70	0.39
•	13	1.83mm	.072"	0.53	0.61	0.67	0.89	0.50
•	12	2.05mm	.081"	0.61	0.73	0.84	1.12	0.63
•	11	2.31mm	.091"	0.78	0.91	1.05	1.42	0.79
•	10	2.59mm	.102"	0.98	1.11	1.33	1.78	0.99
•	9	2.91mm	.114"	1.34	1.52	1.73	2.23	1.25
•	8	3.26mm	.128"	1.62	1.87	2.13	2.81	1.58
•	7	3.67mm	.144"	2.00	2.32	2.65	3.55	2.00
•	6	4.12mm	.162"	2.97	2.80	3.49	4.50	2.52

ROUND WIRE (Based on 20 Gauge)	Approximate Pricing Per Pennyweight (dwt)		
	1 dwt	50 dwt	100 dwt
10K Yellow or White	\$33.23	\$31.44	\$31.14
14K Yellow or White	\$44.05	\$42.25	\$41.96
18K Yellow or White	\$55.09	\$53.29	\$52.99
.950/05 Platinum/Ruthenium	\$77.95	\$76.92	\$76.81
Palladium	\$50.66	\$49.63	\$49.51

Minimum orders:

6-12 gauges – 1 inch per size and quality.

14-24 gauges – 3 inches per size and quality.

25-30 gauges – 36 inches per size and quality.

18, 20, 22, 24, 28 and 30 gauges are also available in Stulladium (silver/palladium).

LEAD TIMES: 10K yellow, 14K yellow, 14K white, 18K yellow and sterling silver will ship same day in most cases. Back orders will ship the following day. All other metal qualities are MTO (made to order) and will ship within three working days in most cases. Same-day shipping subject to order specifications, special request, and inventory on hand at time of order. Additional charges and lead times may apply to odd quantities.



100% Recycled Gold and Silver.
Visit Stuller.com/SensibleSourcing for more information.

See page 336 for all qualities available.	YELLOW 10K 14K 18K	RED 10K 14K 18K	WHITE 10K 14K 14X1 18K	GREEN 10K 14K 18K	.950 PLATINUM COBALT	STERILUM PLUS
---	------------------------------------	---------------------------------	---	-----------------------------------	-----------------------------	----------------------

SILVER ROUND

Coiled Round Wire is available in soft or standard temper (1/2 hard). **Small Diameter Wire** is sold in 100 pennyweight increments only. Supplied 1/2 hard in plastic spools. Available in 26, 28, and 30 gauges. **.9995+ Fine Silver Round Wire** is supplied dead soft and coiled. 26, 28 and 30 gauge wire are sold in 100 dwt spools only.



Profile	Thickness		Minimum Order	Approximate dwt/ft.	20 dwt (1 oz.) Length (in.)			100 dwt (5 oz.) Length (ft.)			
	Gauge	mm			Inch	Sterlium/Fine	Sterlium	Fine	Continuum	Sterlium	Fine
·	30	.26mm	.010"	72"	0.10	2342"	—	2953"	975.7	959.9	1230.4
·	28	.32mm	.013"	72"	0.15	1475"	—	1861"	614.8	604.8	775.2
·	26	.41mm	.016"	72"	0.23	927"	—	—	386.1	379.8	—
·	24	.51mm	.020"	36"	0.40	579"	570"	731"	241.5	237.5	304.5
·	22	.64mm	.025"	36"	0.65	366"	360"	461"	152.4	150.0	192.2
·	21	.72mm	.028"	24"	0.80	288"	—	—	120.1	120.1	—
·	20	.81mm	.032"	24"	1.00	229"	225"	288"	95.3	93.7	120.2
·	18	1.02mm	.040"	24"	1.74	144"	142"	182"	60.0	59.1	75.5
·	16	1.29mm	.051"	24"	2.71	91"	89"	114"	37.8	37.2	47.6
·	14	1.63mm	.064"	12"	4.08	57"	56"	72"	23.8	23.4	30.0
·	12	2.05mm	.080"	12"	6.72	36"	—	—	15.0	14.7	—
·	10	2.59mm	.102"	12"	11.16	23"	—	—	9.4	9.2	—
·	9	2.91mm	.114"	12"	13.44	18"	—	18"	7.5	7.5	7.5
·	8	3.26mm	.128"	12"	16.80	14"	—	—	5.9	5.8	—
·	6	4.12mm	.162"	12"	28.32	9"	—	—	3.7	3.7	—
·	4	5.19mm	.204"	12"	43.50	6"	—	—	2.3	2.3	—

SILVER COILED WIRE	Approximate Pricing Per Pennyweight (dwt)/Ounce (oz)					
	1 dwt	1 oz	400 dwt	20 oz	1000 dwt	50 oz
Continuum® Sterling Silver	\$2.84	\$56.80	\$2.77	\$55.40	\$2.75	\$55.00
Fine Silver	\$1.27	\$25.40	\$1.21	\$24.20	\$1.19	\$23.80
Sterlium Plus™	\$1.32	\$26.40	\$1.26	\$25.20	\$1.24	\$24.80

SILVER SPOOLED WIRE	Approximate Pricing Per Pennyweight (dwt)/Ounce (oz)					
	1 dwt	1 oz	400 dwt	20 oz	1000 dwt	50 oz
Continuum® Sterling Silver	\$2.84	\$56.80	\$2.77	\$55.40	\$2.75	\$55.00
Fine Silver	\$1.29	\$25.80	\$1.23	\$24.60	\$1.20	\$24.00
Sterlium Plus™	\$1.59	\$21.80	\$1.53	\$30.60	\$1.50	\$30.00



YELLOW GOLD-FILLED

1/20 14kt yellow gold-filled. 5% 14kt yellow gold by weight. Yellow gold-filled round wire is supplied soft and coiled in all gauges listed below. Half-hard coiled wire is available in 16 gauge through 24 gauge.

Profile	Thickness		Minimum Order	Approximate dwt/ft.	20 dwt (1 oz.)	100 dwt (5 oz.)	Available Temper	
	Gauge	mm			Inch	Length (in.)		Length (ft.)
·	26	0.41mm	.016"	60"	0.24	1000"	416.7	Soft
·	24	0.51mm	.020"	60"	0.36	667"	277.8	1/2 Hard, Soft
·	22	0.64mm	.025"	60"	0.60	400"	166.7	1/2 Hard
·	21	0.72mm	.028"	48"	0.71	339"	141.3	1/2 Hard
·	20	0.81mm	.032"	36"	0.96	250"	104.1	1/2 Hard, Soft
·	18	1.02mm	.040"	24"	1.45	167"	69.5	1/2 Hard, Soft
·	16	1.29mm	.051"	24"	2.28	105"	43.9	1/2 Hard, Soft
·	14	1.63mm	.064"	12"	3.84	63"	26	1/2 Hard, Soft
·	12	2.05mm	.080"	12"	4.80	50"	17.9	1/2 Hard
·	10	2.59mm	.102"	6"	9.36	26"	10.7	Soft
·	8	3.26mm	.128"	6"	15.00	16"	6.7	Soft

YGF ROUND WIRE	Approximate Pricing Per Pennyweight (dwt)/Ounce (oz)					
	1 dwt	1 oz	50 dwt	25 oz	100 dwt	50 oz
1/20 14K Yellow Gold Filled	\$3.65	\$73.00	\$3.19	\$63.80	\$3.04	\$60.80

STULLER METALS CLUB

Call 877-619-2173 to join the Metals Club and start saving today.

LASER WIRE SPOOLS

All laser wires are annealed dead soft to provide the best weld possible. They come packaged in reusable plastic spools and available in lengths, ranging from 3 feet to 20 feet. Prices based on 20-foot spools unless otherwise noted. (*) Denotes those provided in 30 gauge spools.



Metal Quality	28 Gauge Kit		30 Gauge Kit		Individual Spools				20 ft. Spool Price
	3 ft. Spool \$450.00	3 ft. Spool \$270.00	Spool Gauge	Pennyweights (dwt) Per Spool	3 ft.	5 ft.	10 ft.	20 ft.	
10K Yellow	√	—	28	—	0.90	1.80	3.60	\$139.42	
10K Yellow	—	√	30	—	0.59	1.19	2.27	\$87.91	
10K Yellow	—	—	36	—	0.14	0.28	0.58	\$22.60	
14K Yellow	—	—	28	—	1.01	2.02	4.00	\$198.19	
14K Yellow	—	—	30	—	0.62	1.28	2.50	\$123.87	
14K Yellow	—	—	32	—	—	—	1.64	\$82.00	
14K Yellow	—	—	36	—	0.17	0.32	0.65	\$32.53	
14K Yellow (Zinc-Free)	√	—	28	—	—	—	1.01	\$218.30	
14K Yellow (Zinc-Free)	—	√	30	—	—	—	2.77	\$137.57	
14K Yellow (Zinc-Free)	—	—	36	—	—	—	0.69	\$34.74	
14K White	—	—	28	—	—	—	4.01	\$198.34	
14K White	—	—	32	—	—	—	1.64	\$81.94	
14K White	—	—	36	—	—	.316	0.63	\$15.77	
14K X1® White	—	—	30	—	0.62	1.29	2.54	\$125.69	
14K Palladium White	√	—	28	—	1.13	2.27	4.54	\$246.84	
14K Palladium White	—	√	30	—	0.75	0.15	2.86	\$155.42	
14K Palladium White	—	—	32	—	—	—	1.83	\$100.31	
14K Palladium White	—	—	36	—	0.15	0.32	0.71	\$38.99	
14K Red	—	—	30	—	0.65	1.25	2.50	\$123.87	
14K Red	—	—	36	—	—	0.32	—	\$16.05	
18K Yellow	√	—	28	—	.021	1.22	2.49	\$296.63	
18K Yellow	—	√	30	—	0.81	1.62	3.24	\$196.30	
18K Yellow	—	—	33	—	—	—	1.55	\$94.82	
18K Yellow	—	—	36	—	0.17	0.35	0.81	\$49.30	
18K Yellow (Zinc-Free)	—	—	28	—	—	—	0.91	\$58.05	
18K Yellow (Zinc-Free)	—	—	30	—	—	—	3.24	\$197.80	
18K Yellow (Zinc-Free)	—	—	36	—	—	—	0.02	\$49.67	
18K White	√	—	28	—	1.16	2.31	4.63	\$280.01	
18K White	—	√	30	—	0.73	1.52	2.90	\$175.31	
18K White	—	—	32	—	—	—	1.87	\$114.10	
18K White	—	—	36	—	0.16	0.40	0.76	\$46.32	
18K Palladium White	√	—	28	—	1.28	2.56	5.15	\$346.34	
18K Palladium White	—	√	30	—	0.85	1.61	3.38	\$227.58	
18K Palladium White	—	—	33	—	—	—	1.62	\$109.98	
18K Palladium White	—	—	36	—	0.18	0.36	0.75	\$50.81	
18K Green	—	—	36	—	—	—	0.78	\$47.69	
19K White	—	—	30	—	.761	1.52	3.046	\$198.89	
19K White	—	—	36	—	.19	0.38	0.76	\$49.68	
22K Yellow	—	—	30	—	—	1.86	—	\$132.43	
Silver Eye-Glass Frame Wire	√ (*)	√	30	—	—	—	2.41	\$9.59	
Silver Eye-Glass Frame Wire	—	—	36	—	—	—	0.58	\$3.29	
Silver Weld-Hard	√ (*)	√	30	—	—	—	0.52	\$9.54	
Silver Braze-Easy	—	√	30	—	—	—	0.14	\$8.80	
Silver Weld/Braze-Medium	—	—	30	—	—	—	1.99	\$9.20	
Super Sterling Silver	—	—	28	—	—	—	3.31	\$15.33	
Super Sterling Silver	—	—	30	—	—	—	2.04	\$9.45	
Super Sterling Silver	—	—	36	—	—	—	0.51	\$2.35	
Continuum® Sterling Silver	—	—	30	—	—	—	2.06	\$13.31	
Continuum® Sterling Silver	—	—	36	—	—	—	0.53	\$3.40	
Sterium Plus	—	—	30	—	—	—	2.07	\$9.59	
Silver/Palladium (Stulladium)	—	—	30	—	—	—	2.16	\$53.50	
Titanium	√ (*)	√	30	—	—	—	.896	\$9.95	
Stainless Steel	√	—	28	—	—	—	2.11	\$7.95	
Stainless Steel	—	√	30	—	—	—	1.70	\$7.95	
Stainless Steel	—	—	36	—	—	—	0.38	\$7.95	
.900/.10 Platinum/Iridium	√	—	28	—	—	—	1.02	\$79.47	
.900/.10 Platinum/Iridium	—	√	30	—	—	—	0.64	\$53.52	
.900/.10 Platinum/Iridium	—	—	33	—	—	—	2.16	\$169.14	
.900/.10 Platinum/Iridium	—	—	36	—	—	0.54	—	\$41.96	
.950/.05 Platinum/Ruthenium	—	—	28	0.98	—	—	—	\$81.68	
.950/.05 Platinum/Cobalt	√	—	28	0.98	—	—	—	\$81.70	
.950/.05 Platinum/Cobalt	—	—	36	1.03	—	—	—	\$86.37	

SPEEDWIRE DISPENSERS AND STAND

Ever dreamed of the day when you'd feed laser wire into a weld with ease! Today, with the Speedwire dispenser system, you can do it. The Speedwire system features a specially designed dispenser with a finger-controlled feed. Use this one-handed operation to get in as close as 2mm from the weld. How's that for improving your accuracy?

Each reloadable dispenser is able to hold a ten-foot wire spool in its clear, sealed compartment. Monitor how much you've used while keeping it neat and clean. The wire feeds through a stainless steel guide for stability. No need to keep repositioning the wire to get it in just the right spot. The dispensers are color-coded so you can tell one metal from another. This is definitely a tool you won't want to live without.



Order #	Description	Jeweler's Cost
SPEEDWIRE:100:T	Dispenser Stand (Holds 8)	\$19.95
SPEEDWIRE:101:T	Reloadable Blue Dispenser for White Wire	\$23.00
SPEEDWIRE:102:T	Reloadable Red Dispenser for Yellow Wire	\$23.00
SPEEDWIRE:103:T	Reloadable White Dispenser for Silver Wire	\$23.00
SPEEDWIRE:104:T	Reloadable Purple Dispenser for Platinum/Palladium Wire	\$23.00
SPEEDWIRE:119:T	Repair Kit (Includes axle, wheel, spring, plunger, and guide tube)	\$6.00

SPEEDWIRE LASER WIRE

Order #	Description	Jeweler's Cost
SPEEDWIRE:138:P	14kt White 28 Gauge (.32mm) 10ft. Spool	\$99.05
SPEEDWIRE:106:P	14kt X1® White 30 Gauge (.26mm) 10ft. Spool	\$62.00
SPEEDWIRE:108:P	14kt Palladium White 30 Gauge (.26mm) 10ft. Spool	\$77.71
SPEEDWIRE:133:P	14kt Yellow 28 Gauge (.32mm) 10ft. Spool	\$100.66
SPEEDWIRE:105:P	14kt Yellow 30 Gauge (.26mm) 10ft. Spool	\$63.62
SPEEDWIRE:107:P	14kt Yellow (Zinc-free) 30 Gauge (.26mm) 10ft. Spool	\$68.49
SPEEDWIRE:110:P	18kt White 30 Gauge (.26mm) 10ft. Spool	\$87.78
SPEEDWIRE:126:P	18kt Palladium White 28 Gauge (.32mm) 10ft. Spool	\$171.89
SPEEDWIRE:112:P	18kt Palladium White 30 Gauge (.26mm) 10ft. Spool	\$113.52
SPEEDWIRE:117:P	18kt Palladium White 33 Gauge (.18mm) 10ft. Spool	\$54.80
SPEEDWIRE:130:P	18kt Palladium White 33 Gauge (.18mm) 15ft. Spool	\$81.71
SPEEDWIRE:121:P	18kt Palladium White 36 Gauge (.13mm) 10ft. Spool	\$27.30
SPEEDWIRE:127:P	18kt Palladium White 36 Gauge (.13mm) 20ft. Spool	\$54.63
SPEEDWIRE:109:P	18kt Yellow 30 Gauge (.26mm) 10ft. Spool	\$93.35
SPEEDWIRE:116:P	18kt Yellow 33 Gauge (.18mm) 10ft. Spool	\$47.41
SPEEDWIRE:125:P	18kt Yellow (Zinc-free) 28 Gauge (.32mm) 10ft. Spool	\$150.92
SPEEDWIRE:111:P	18kt Yellow (Zinc-free) 30 Gauge (.26mm) 10ft. Spool	\$95.02
SPEEDWIRE:124:P	18kt Yellow (Zinc-free) 33 Gauge (.18mm) 10ft. Spool	\$48.13
SPEEDWIRE:129:P	18kt Yellow (Zinc-free) 33 Gauge (.18mm) 15ft. Spool	\$72.01
SPEEDWIRE:123:P	18kt Yellow (Zinc-free) 36 Gauge (.13mm) 10ft. Spool	\$23.93
SPEEDWIRE:128:P	18kt Yellow (Zinc-free) 36 Gauge (.13mm) 20ft. Spool	\$47.27
SPEEDWIRE:122:P	18kt Rose 34 Gauge (.16mm) 10ft. Spool	\$35.86
SPEEDWIRE:134:P	19kt White 30 Gauge (.26mm) 10ft. Spool	\$99.44
SPEEDWIRE:132:P	Silver Weld-Hard 30 Gauge (.26mm) 10ft. Spool	\$4.12
SPEEDWIRE:113:P	AGPD (Silver/Palladium) 30 Gauge (.26mm) 10ft. Spool	\$26.80
SPEEDWIRE:136:P	Continuum® Sterling Silver 30 Gauge (.26mm) 10ft. Spool	\$6.67
SPEEDWIRE:137:P	Continuum® Sterling Silver 36 Gauge (.13mm) 10ft. Spool	\$1.67
SPEEDWIRE:114:P	PT58 (.585 Platinum) 30 Gauge (.26mm) 10ft Spool	\$131.65
SPEEDWIRE:01180:P	PLIR (Platinum/Iridium) 28 Gauge (.32mm) 10ft. Spool	\$262.31
SPEEDWIRE:011180:P	PLIR (Platinum/Iridium) 30 Gauge (.26mm) 10ft. Spool	\$166.80
SPEEDWIRE:131:P	PLIR (Platinum/Iridium) 33 Gauge (.18mm) 15ft. Spool	\$125.76
SPEEDWIRE:135:P	PLIR (Platinum/Iridium) 36 Gauge (.13mm) 20ft. Spool	\$83.30
SPEEDWIRE:115:P	PLRU (Platinum/Ruthenium) 30 Gauge (.26mm) 10ft. Spool	\$171.54
SPEEDWIRE:118:P	PLRU (Platinum/Ruthenium) 33 Gauge (.18mm) 10ft. Spool	\$84.57



Winner of
the 2010 MJSA
"Thinking Ahead"
Award

STULLER
METALS CLUB

Call 877-619-2173 to join the
Metals Club and start saving today.



Pre-Cut Preform Sizing Stock is pre-measured to size rings 1/2 to 3 1/2 sizes up in 1/2 size increments in 1, 1 1/2, 2, 3, 4, and 5 mm pre-cut lengths. Sterling silver pre-cut Preform Sizing Stock is available in 5 dwt minimums.



Maximum straight length is 36 inches.

**Minimum order for:
Sterling Silver Bulk is 12 inches.
Gold Bulk is 1 inch.**

PREFORM™ SIZING STOCK

Preform Sizing Stock is supplied in straight lengths with a medium hard temper unless otherwise requested. Available qualities will include 10kt, 14kt, 14X1®, 18kt, and sterling silver (limited sizes available). Additional sizes available in 2.5 mm thickness in sterling silver.

Profile	Thickness		PREFORM BULK			PREFORM PRE-CUT				
	Ring Size	Shank	Approximate			Approximate Price Per Piece				
	(mm × width)	(mm)	Pennyweight (dwt) Per Inch			Based on 14K Yellow Gold				
			10K	14K	18K	1.5mm	2.0mm	3.0mm	4.0mm	5.0mm
	1 × .5	.35-.6	0.38	0.43	0.51	\$1.11	\$1.53	\$2.30	\$3.07	\$3.83
	1 × 1	.35-.6	0.62	0.70	0.83	\$1.86	\$2.50	\$3.72	\$4.96	\$6.20
	1 × 1.5	.35-.6	0.86	0.97	1.15	\$2.57	\$3.43	\$5.14	\$6.86	\$8.57
	1 × 2	.35-.6	1.10	1.23	1.47	\$3.28	\$4.38	\$6.52	\$8.75	\$10.94
	1 × 2.5	.35-.6	1.35	1.51	1.80	\$4.03	\$5.37	\$8.05	\$10.74	\$13.42
	1 × 3	.35-.6	1.57	1.77	2.10	\$4.70	\$6.27	\$9.41	\$12.54	\$15.68
	1 × 3.5	.35-.6	1.83	2.06	2.45	\$5.48	\$7.31	\$10.96	\$14.62	\$18.27
	1.2 × .5	.7-1.08	0.49	0.56	0.66	\$1.48	\$1.98	\$2.93	\$3.95	\$4.94
	1.2 × 1	.7-1.08	0.77	0.87	1.04	\$2.32	\$3.09	\$4.64	\$6.19	\$7.74
	1.2 × 1.5	.7-1.08	1.05	1.18	1.41	\$3.15	\$4.07	\$6.29	\$8.39	\$10.49
	1.2 × 2	.7-1.08	1.34	1.51	1.79	\$4.02	\$5.35	\$8.03	\$10.70	\$13.38
	1.2 × 2.5	.7-1.08	1.62	1.82	2.17	\$4.85	\$6.47	\$9.70	\$12.94	\$16.17
	1.2 × 3	.7-1.08	1.91	2.15	2.55	\$5.72	\$7.62	\$11.44	\$15.25	\$19.06
	1.2 × 3.5	.7-1.08	2.16	2.43	2.89	\$6.48	\$8.64	\$12.95	\$17.27	\$21.59
	1.5 × .5	1.09-1.36	0.69	0.77	0.92	\$2.05	\$2.73	\$3.99	\$5.47	\$6.84
	1.5 × 1	1.09-1.36	1.03	1.16	1.38	\$3.09	\$4.12	\$6.28	\$8.24	\$10.30
	1.5 × 1.5	1.09-1.36	1.39	1.56	1.86	\$4.16	\$5.54	\$8.31	\$11.08	\$13.86
	1.5 × 2	1.09-1.36	2.00	2.25	2.68	\$4.78	\$6.95	\$10.42	\$13.96	\$19.98
	1.5 × 2.5	1.09-1.36	2.14	2.40	2.86	\$6.39	\$8.53	\$12.79	\$17.05	\$21.31
	1.5 × 3	1.09-1.36	2.48	2.79	3.32	\$7.44	\$9.90	\$14.87	\$19.82	\$24.78
	1.5 × 3.5	1.09-1.36	2.85	3.20	3.81	\$8.53	\$11.37	\$17.05	\$22.73	\$28.42
	1.75 × .5	1.37-1.61	0.85	0.95	1.13	\$2.53	\$3.37	\$5.06	\$6.75	\$8.44
	1.75 × 1	1.37-1.61	1.25	1.40	1.67	\$3.73	\$4.97	\$7.46	\$9.94	\$12.43
	1.75 × 1.5	1.37-1.61	1.71	1.92	2.28	\$5.12	\$6.82	\$10.23	\$13.64	\$17.05
	1.75 × 2	1.37-1.61	2.00	2.25	2.68	\$6.00	\$7.99	\$11.99	\$15.99	\$19.99
	1.75 × 2.5	1.37-1.61	2.60	2.92	3.47	\$7.78	\$10.38	\$15.56	\$20.75	\$25.94
	1.75 × 3	1.37-1.61	2.87	3.22	3.83	\$8.58	\$11.44	\$17.16	\$22.88	\$28.60
	1.75 × 3.5	1.37-1.61	3.40	3.82	4.55	\$10.18	\$13.57	\$20.36	\$27.14	\$33.93
	2 × .5	1.62-1.86	1.04	1.17	1.39	\$3.12	\$4.16	\$6.24	\$8.32	\$10.40
	2 × 1	1.62-1.86	1.52	1.71	2.03	\$4.56	\$6.07	\$9.11	\$12.15	\$15.18
	2 × 1.5	1.62-1.86	2.00	2.25	2.68	\$6.00	\$7.99	\$11.99	\$15.99	\$19.99
	2 × 2	1.62-1.86	2.49	2.80	3.33	\$7.46	\$9.94	\$14.92	\$19.89	\$24.86
	2 × 2.5	1.62-1.86	2.96	3.33	3.96	\$8.87	\$11.83	\$17.74	\$23.66	\$29.57
	2 × 3	1.62-1.86	3.52	3.95	4.70	\$10.53	\$14.03	\$21.05	\$28.06	\$35.08
	2 × 3.5	1.62-1.86	3.96	4.45	5.30	\$11.86	\$15.81	\$23.71	\$31.62	\$39.52

PREFORM SIZING STOCK	Approximate Pricing Per Pennyweight (dwt)		
	1 dwt	50 dwt	100 dwt
10K Yellow or White	\$34.35	\$32.52	\$32.22
14K Yellow or White	\$45.17	\$43.34	\$43.03
18K Yellow or White	\$56.21	\$54.38	\$54.07

See page 336 for all qualities available.	YELLOW 10K 14K 18K	RED 10K 14K 18K	WHITE 10K 14K 14X1 18K	GREEN 10K 14K 18K	.950 PLATINUM COBALT 	STERLIUM PLUS
---	------------------------------------	---------------------------------	---	-----------------------------------	---------------------------------	--------------------------

REFINED KARATS

 100% Recycled Gold and Silver.
 Visit Stuller.com/SensibleSourcing for more information.

FLAT SIZING STOCK

Flat sizing stock is offered in straight lengths with 1/2 hard temper unless otherwise requested. Annealing is available upon request.

	Profile	Size (mm)	Minimum Order	Approximate Pennyweights (dwt) Per Inch					
				10K	14K	18K	Plat/Ru	.950 Pd	Sterlium Plus™
1.5x	—	1.5 x .75	3"	0.20	0.24	0.26	0.38	0.21	0.19
	—	1.5 x 1	3"	0.28	0.30	0.38	0.51	0.29	0.26
2x	—	2 x .75	3"	0.29	0.39	0.35	0.51	0.29	0.26
	—	2 x 1	3"	0.37	0.41	0.52	0.68	0.38	0.35
	—	2 x 1.25	3"	0.49	0.54	0.64	0.85	0.48	0.42
	—	2 x 1.5	3"	0.56	0.63	0.71	1.01	0.58	0.51
2.5x	—	2.5 x .75	3"	0.34	0.39	0.44	0.63	0.35	0.32
	—	2.5 x 1	3"	0.46	0.53	0.62	0.85	0.48	0.43
	—	2.5 x 1.25	1"	0.56	0.63	0.75	1.06	0.60	0.51
	—	2.5 x 1.5	1"	0.68	0.79	0.91	1.27	0.68	0.64
3x	—	2.5 x 2	1"	0.89	1.05	1.22	1.69	0.97	0.83
	—	3 x .75	1"	0.40	0.50	0.57	0.76	0.44	0.37
	—	3 x 1	1"	0.56	0.63	0.76	1.01	0.57	0.50
	—	3 x 1.25	1"	0.68	0.78	0.93	1.27	0.73	0.63
	—	3 x 1.5	1"	0.82	0.94	1.12	1.52	0.87	0.74
	—	3 x 2	1"	1.16	1.26	1.49	2.03	1.16	1.04
3.5x	—	3 x 2.5	1"	1.35	1.50	1.83	2.54	1.45	1.24
	—	3.5 x 1	1"	0.68	0.73	0.88	1.18	1.02	0.62
	—	3.5 x 1.5	1"	0.92	1.11	1.35	1.77	1.02	0.88
	—	3.5 x 2	1"	1.31	1.45	1.74	2.37	1.35	1.25
4x	—	3.5 x 2.5	1"	1.45	1.85	2.20	2.96	1.69	1.49
	—	4 x .75	1"	0.58	0.62	0.75	1.01	0.65	0.57
	—	4 x 1	1"	0.76	0.84	1.00	1.35	0.76	0.65
	—	4 x 1.25	1"	0.95	1.04	1.28	1.69	1.09	0.82
	—	4 x 1.5	1"	1.12	1.26	1.51	2.03	1.13	0.98
	—	4 x 2	1"	1.49	1.68	1.93	2.70	1.74	1.32
4.5x	—	4 x 2.25	1"	1.69	1.96	2.21	3.04	1.96	1.68
	—	4 x 3	1"	2.17	2.69	2.98	4.06	2.61	2.10
	—	4.5 x 1	1"	0.86	0.95	—	1.52	0.87	0.75
	—	4.5 x 1.5	1"	1.22	1.44	1.67	2.28	1.31	1.15
5x	—	4.5 x 2	1"	1.65	1.89	2.25	3.04	1.74	1.58
	—	5 x .75	1"	0.74	0.79	0.99	1.27	0.73	0.68
	—	5 x 1	1"	0.94	1.07	1.27	1.69	0.95	0.81
	—	5 x 1.25	1"	1.16	1.33	1.56	2.11	1.21	1.05
	—	5 x 1.5	1"	1.40	1.58	1.85	2.54	1.45	1.24
	—	5 x 2	1"	1.86	2.11	2.51	3.38	1.89	1.67
6x	—	5 x 2.5	1"	2.26	2.59	3.13	4.23	2.42	2.22
	—	6 x 1	1"	1.11	1.24	1.48	2.03	1.16	1.01
	—	6 x 1.5	1"	1.65	1.89	2.28	3.04	1.74	1.51
	—	6 x 2	1"	2.24	2.53	2.98	4.06	2.32	1.93
7x	—	6 x 2.5	1"	2.93	3.15	3.80	5.07	2.84	2.62
	—	7 x 1	1"	1.31	1.52	1.73	2.37	1.35	1.23
	—	7 x 1.5	1"	1.97	2.21	2.63	3.55	2.03	1.75
	—	7 x 2	1"	2.54	2.95	3.43	4.73	2.65	2.49
8x	—	7 x 2.5	1"	3.44	3.71	4.43	5.92	3.39	3.09
	—	8 x 1	1"	1.52	1.72	2.08	2.70	1.55	1.33
	—	8 x 1.5	1"	2.21	2.48	2.96	3.85	2.32	2.05
	—	8 x 2	1"	2.92	3.33	3.85	5.41	3.10	2.58
10x	—	8 x 2.5	1"	3.67	4.12	5.06	6.76	3.78	3.29
	—	10 x 1	1"	2.18	2.11	2.50	3.38	1.94	1.77
	—	10 x 1.5	1"	2.75	3.17	3.83	5.07	2.90	2.54



In order to determine what size best fits your needs, you must first measure the width, then the thickness.



FLAT SIZING STOCK	Approximate Pricing		
	1 dwt	50 dwt	100 dwt
10K Yellow or White	\$33.35	\$31.52	\$31.22
14K Yellow or White	\$44.17	\$42.34	\$42.03
18K Yellow or White	\$55.21	\$53.38	\$53.07
.950/.05 Platinum/Ruthenium	\$77.95	\$76.92	\$76.81
Palladium	\$50.66	\$49.63	\$49.51

SILVER FLAT SIZING STOCK					
Sterlium Plus™					
Approximate Pricing					
1 dwt	1 oz	4000 dwt	20 oz	1000 dwt	50 oz
\$1.40	\$28.00	\$1.32	\$26.40	\$1.29	\$25.80

Maximum straight length is 36 inches.

Minimum order for Sterling Silver is 12 inches per size.

STULLER
METALS CLUB

Call 877-619-2173 to join the Metals Club and start saving today.

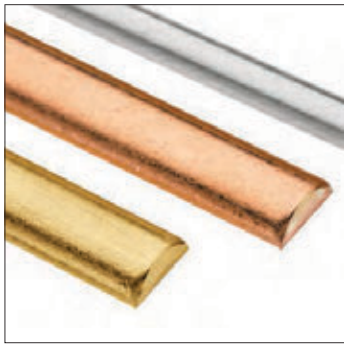

Half-Round Sizing Stock is supplied in straight lengths with a 1/2 hard temper unless otherwise requested. Coiled sizing stock can be made-to-order with additional lead times. Annealing is available upon request.

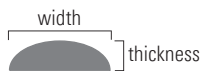

In order to determine what size best fits your needs, you must first measure the width, then the thickness.

LEAD TIMES: 10K yellow, 14K yellow, 14K white, 18K yellow and sterling silver will ship same day in most cases. Back orders will ship the following day. All other metal qualities are MTO (made to order) and will ship within three working days in most cases. Same-day shipping subject to order specifications, special request, and inventory on hand at time of order. Additional charges and lead times may apply to odd quantities.

Maximum straight length is 36 inches.

HALF-ROUND SIZING STOCK

	Profile	Size (mm)	Minimum Order	Approximate Pennyweights (dwt) Per Square Inch				
				10K	14K	18K	Plat/Ru	Sterlium Plus™
1x	—	1 x .5	3"	0.10	0.11	0.13	0.18	0.09
1.5x	—	1.5 x .75	3"	0.24	0.23	0.27	0.33	0.18
	—	1.5 x 1	3"	0.24	0.27	0.42	0.47	0.21
1.75x	—	1.75 x 1	3"	0.33	0.32	0.38	0.64	0.21
	—	2 x 1	3"	0.32	0.38	0.51	0.56	0.31
2x	—	2 x 1.5	1"	0.50	0.63	0.70	0.97	0.50
2.25x	—	2.25 x 1.5	1"	0.58	0.67	0.73	1.09	0.47
	—	2.5 x 1.25	1"	0.53	0.58	0.69	0.92	0.42
2.5x	—	2.5 x 1.5	1"	0.63	0.73	0.83	1.17	0.54
	—	2.5 x 2	1"	0.88	0.98	1.11	1.53	0.70
	—	3 x 1	1"	0.51	0.56	0.55	0.77	0.37
3x	—	3 x 1.5	1"	0.74	0.83	1.01	1.35	0.67
	—	3 x 2	1"	0.98	1.11	1.34	1.83	0.84
3.5x	—	3.5 x 1.5	1"	0.92	0.90	1.08	1.51	0.77
	—	3.5 x 2	1"	1.13	1.23	1.51	2.07	1.02
4x	—	4 x 1	1"	0.55	0.61	0.73	1.01	0.55
	—	4 x 1.5	1"	0.90	1.08	1.22	1.66	0.86
	—	4 x 2	1"	1.18	1.44	1.66	2.39	1.18
4.5x	—	4.5 x 1.5	1"	1.03	1.11	1.71	1.89	0.93
	—	4.5 x 2	1"	1.14	1.57	1.85	2.55	1.26
5x	—	5 x 1	1"	0.93	0.95	0.93	1.29	0.75
	—	5 x 1.5	1"	1.13	1.27	1.54	2.11	1.02
	—	5 x 2	1"	1.52	1.77	2.11	2.92	1.37
	—	5 x 2.5	1"	2.0241	2.16	2.53	4.00	1.76
	—	5 x 3	1"	—	2.66	3.32	4.33	2.12
6x	—	6 x 1	1"	0.94	0.05	1.25	1.74	0.83
	—	6 x 1.25	1"	1.24	1.32	1.52	2.31	1.08
	—	6 x 1.5	1"	1.26	1.49	1.78	2.52	1.13
	—	6 x 2	1"	1.80	2.06	2.48	3.29	1.60
	—	6 x 2.5	1"	2.25	2.54	3.06	4.16	2.52
7x	—	6 x 3	1"	2.77	3.20	3.83	5.32	2.52
	—	7 x 1	1"	1.15	1.29	1.54	2.13	1.02
	—	7 x 1.5	1"	1.38	1.90	2.05	2.83	1.41
	—	7 x 2	1"	2.03	2.41	2.88	3.61	1.83
8x	—	7 x 2.5	1"	2.68	3.11	3.48	4.58	2.35
	—	8 x 1.25	1"	1.59	1.69	1.98	2.97	1.40
	—	8 x 1.5	1"	1.69	2.02	2.42	3.17	1.50
	—	8 x 1.7	1"	2.13	2.35	2.79	3.97	1.88
10x	—	8 x 2	1"	2.27	2.79	3.18	4.22	2.03
	—	10 x 1.25	1"	2.04	2.27	2.96	3.80	1.77
12x	—	12 x 1.5	1"	2.75	3.01	3.57	5.12	2.41
	—	12 x 1.7	1"	3.79	3.60	4.15	5.95	2.80
15x	—	15 x 1.7	1"	4.07	4.59	5.28	7.71	3.58
18x	—	18 x 1.7	1"	4.85	5.46	6.29	9.02	4.2

HALF-ROUND SIZING STOCK	Approximate Pricing Per Pennyweight (dwt)		
	1 dwt	50 dwt	100 dwt
10K Yellow or White	\$33.35	\$31.52	\$31.22
14K Yellow or White	\$44.17	\$42.34	\$42.03
18K Yellow or White	\$55.21	\$53.38	\$53.07
.950/.05 Platinum/Ruthenium	\$77.95	\$76.92	\$76.81





HALF-ROUND SIZING STOCK Sterlium Plus™					
Approximate Pricing Per Pennyweight (dwt)/Ounce (oz)					
1 dwt	1 oz	400 dwt	20 oz	1000 dwt	50 oz
\$1.40	\$28.00	\$1.32	\$26.40	\$1.29	\$25.80

100% Recycled Gold and Silver. Visit Stuller.com/SensibleSourcing for more information.



COMFORT FIT SIZING STOCK

Perfect for fabricating comfort-fit rings and sizing comfort-fit bands. Supplied in straight lengths with 1/2 hard temper unless otherwise requested. Coiled sizing stock can be made-to-order with additional lead times. Annealing is available upon request.

Profile	Size (mm)	Minimum Order	Approximate Pennyweights (dwt) Per Inch				
			10K	14K	18K	Plat/Ru	Sterilum Plus™
	3 x 2	1"	0.98	1.11	1.32	1.81	0.87
	4 x 2	1"	1.27	1.43	1.70	2.35	1.13
	5 x 2	1"	1.53	1.72	2.05	2.83	1.36
	6 x 2	1"	1.80	2.02	2.40	3.31	-

Maximum straight length is 36 inches.

COMFORT-FIT SIZING STOCK	Approximate Pricing Per Pennyweight (dwt)		
	1 dwt	50 dwt	100 dwt
10K Yellow or White	\$33.35	\$31.52	\$31.22
14K Yellow or White	\$44.17	\$42.34	\$42.03
18K Yellow or White	\$55.21	\$53.38	\$53.07
.950/.05 Platinum/Ruthenium	\$77.95	\$76.92	\$76.81



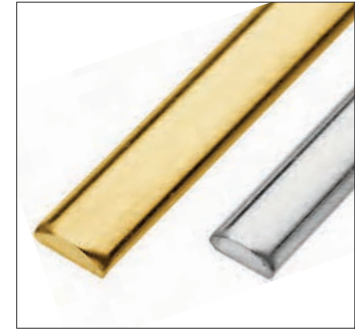





SILVER ROUND TUBING	Approximate Pricing Per Pennyweight (dwt)/Ounce (oz)					
	1 dwt	1 oz	400 dwt	20 oz	1000 dwt	50 oz
Sterilum Plus™	\$1.40	\$28.00	\$1.32	\$26.40	\$1.29	\$25.80



In order to determine what size best fits your needs, you must first measure the width, then the thickness.

STERLING SILVER LOW DOME WIRE

Sterling silver low dome wire is particularly designed to eliminate the sharp edges on conventional half-round wires. Excellent for making bangle bracelets and rings. Supplied soft and coiled.

Profile	Width x Thickness		Minimum Order	Approximate dwt/ft.	20 dwt (1 oz.) Length (inch)	100 dwt (5 oz.) Length (feet)
	(mm)	(inches)				
	5 x 2	.197 x .080	6"	17.3	14	5.8
	6 x 1.7	.236 x .067	6"	17.3	14	5.8
	6 x 2	.236 x .080	6"	20.8	12	4.8
	8 x 1.7	.315 x .067	6"	23.1	10	4.3
	8 x 2	.315 x .080	6"	27.8	9	3.6
	10 x 1.7	.394 x .067	6"	28.8	8	3.5
	10 x 2	.394 x .080	6"	34.7	7	2.9
	12 x 2	.472 x .080	6"	41.6	6	2.4

LOW DOME WIRE	Approximate Pricing Per Pennyweight (dwt)/Ounce (oz)					
	1 dwt	1 oz	400 dwt	20 oz	1000 dwt	50 oz
Sterling Silver	\$1.35	\$27.00	\$1.27	\$25.40	\$1.24	\$24.80



In order to determine what size best fits your needs, you must first measure the width, then the thickness.

YELLOW GOLD FILLED HALF ROUND WIRE

1/20 14kt yellow gold-filled half-round wire is supplied soft, or half hard as noted below.

Profile	Gauge	Width x Thickness		Minimum Order	Approximate dwt/ft.	20 dwt (1 oz.) Length (inch)	Available Temper
		Millimeters	Inches				
-	18	1.02 x 0.51	.040 x .020	60"	0.84	286.0	Half-Hard
	8	3.25 x 1.63	.128 x .064	6"	7.44	32.0	Soft

YGF HALF-ROUND WIRE	Approximate Pricing Per Pennyweight (dwt)/Ounce (oz)					
	1 dwt	1 oz	50 dwt	25 oz	100 dwt	50 oz
1/20 14K Yellow Gold Filled	\$3.65	\$73.00	\$3.19	\$63.80	\$3.04	\$60.80

STULLER METALS CLUB

Call 877-619-2173 to join the Metals Club and start saving today.

Square and Triangle Sizing Stock



Square Sizing Stock is offered in straight lengths with 1/2 hard temper unless otherwise requested. Coiled sizing stock can be made-to-order with additional lead times. Annealing is available upon request.

Maximum length is 36 inches.

SQUARE SIZING STOCK

Profile	Size (mm)	Minimum Order	Approximate Pennyweights (dwt) Per Inch					
			10K	14K	18K	Plat/Ru	Palladium	Sterium Plus™
▪	.75 × .75	3"	0.11	0.12	0.14	0.19	—	0.09
▪	1 × 1	3"	0.19	0.21	0.25	0.34	0.19	0.17
▪	1.25 × 1.25	3"	0.30	0.35	0.38	0.53	0.30	0.26
▪	1.5 × 1.5	3"	0.42	0.47	0.55	0.76	0.43	0.38
▪	1.75 × 1.75	1"	0.58	0.67	0.76	1.04	0.58	0.53
▪	2 × 2	1"	0.76	0.83	1.03	1.45	0.76	0.70
▪	2.25 × 2.25	1"	0.85	1.05	1.14	1.71	0.96	0.88
▪	2.5 × 2.5	1"	1.15	1.31	1.62	2.11	1.18	1.03
▪	3 × 3	1"	1.72	1.83	2.25	3.04	1.70	1.52
▪	3.5 × 3.5	1"	2.30	2.48	2.88	4.14	2.32	1.87
▪	4 × 4	1"	3.01	3.28	3.95	5.41	3.03	2.63
▪	5 × 5	1"	4.84	5.06	6.19	8.45	—	4.26
▪	6 × 6	1"	6.94	7.51	9.14	12.17	6.81	6.11

SQUARE SIZING STOCK	Approximate Pricing Per Pennyweight (dwt)		
	1 dwt	50 dwt	100 dwt
10K Yellow	\$33.35	\$31.52	\$31.22
14K Yellow	\$44.17	\$42.34	\$42.03
18K Yellow	\$55.21	\$53.38	\$53.07
.950/.05 Platinum/Ruthenium	\$77.95	\$76.92	\$76.81
Palladium White	\$50.66	\$49.63	\$49.51



Sterling Silver Square Wire is available coiled in soft and half-hard tempers as listed below.

STERLING SILVER SQUARE WIRE

Profile	Gauge	mm	Inch	Minimum Order	Approximate dwt/ft.	20 dwt (1 oz.) Length (inch)	100 dwt (5 oz.) Length (feet)	Available Temper
▪	22	0.64mm	.025"	60"	0.84	286"	119.0	Soft
▪	20	0.81mm	.032"	36"	1.32	182"	75.80	1/2 Hard
▪	18	1.02mm	.040"	24"	2.16	111"	46.3	1/2 Hard
▪	12	2.05mm	.080"	12"	8.40	29"	11.9	Soft
▪	8	3.26mm	.128"	6"	21.48	11"	4.7	Soft

SILVER SQUARE WIRE	Approximate Pricing Per Pennyweight (dwt)/Ounce (oz)					
	1 dwt	1 oz	400 dwt	20 oz	1000 dwt	50 oz
Sterling Silver	\$1.42	\$28.50	\$1.35	\$27.00	\$1.32	\$26.40



Triangle Sizing Stock is supplied in straight lengths with medium hard temper, unless otherwise requested.

Maximum straight length is 36 inches.

In order to determine what size best fits your needs, you must first measure the width, then the thickness.



TRIANGLE SIZING STOCK

Profile	Size (mm)	Minimum Order	Approximate Pennyweights (dwt) Per Inch			
			10K	14K	18K	Plat/Ru
▲	2 × 1.75	1"	0.33	0.44	0.42	0.72
▲	4 × 3.5	1"	1.33	1.50	1.71	2.36
▲	6 × 5.5	1"	3.00	3.38	3.86	5.58
▲	8 × 7	1"	5.29	5.96	6.88	9.46

TRIANGLE SIZING STOCK	Approximate Pricing Per Pennyweight (dwt)		
	1 dwt	50 dwt	100 dwt
10K Yellow	\$33.35	\$31.52	\$31.22
14K Yellow	\$44.17	\$42.34	\$42.03
18K Yellow	\$55.21	\$53.38	\$53.07
.950/.05 Platinum/Ruthenium	\$77.95	\$76.92	\$76.81

BEZEL STOCK

	Profile	Thickness Gauge	Width Size (mm)	Minimum Order	Approximate Pennyweights (dwt) Per Inch			
					10K	14K	18K	Plat/Ru
2x		22	2mm	12"	0.24	0.27	0.33	0.45
		24	2mm	12"	0.20	—	—	0.36
		26	2mm	12"	0.16	0.18	0.21	0.29
		28	2mm	12"	0.13	0.14	0.17	0.23
		30	2mm	12"	0.13	0.10	0.11	0.18
3x		22	3mm	6"	0.49	0.37	0.41	0.68
		24	3mm	6"	—	0.39	0.33	0.54
		26	3mm	6"	0.31	0.23	0.26	0.43
		28	3mm	6"	0.25	0.19	0.20	0.27
		30	3mm	6"	0.20	0.15	0.16	0.35
4x		22	4mm	6"	0.65	0.49	0.55	0.90
		24	4mm	6"	0.52	0.39	0.44	0.72
		26	4mm	6"	0.42	0.31	0.35	0.58
		28	4mm	6"	0.34	0.25	0.28	0.47
		30	4mm	6"	0.26	0.19	0.22	0.36
5x		22	5mm	6"	0.81	0.61	0.68	1.13
		24	5mm	6"	0.49	—	—	0.90
		26	5mm	6"	0.39	0.72	0.52	0.44
		28	5mm	6"	0.32	0.59	0.42	0.36
		30	5mm	6"	0.24	0.45	0.33	0.27
6x		22	6mm	6"	0.73	1.35	0.98	0.81
		24	6mm	6"	0.58	1.08	.78	0.66
		26	6mm	6"	0.47	0.87	—	0.52
		28	6mm	6"	0.38	0.70	—	0.43
		30	6mm	6"	0.29	0.54	0.39	0.33



Flat Bezel Strips are supplied with a 3/4 hard temper in lengths up to 14 inches. Annealing is available upon request.

FLAT BEZEL	Approximate Pricing		
	1 dwt	50 dwt	100 dwt
10K Yellow or White	\$33.45	\$31.59	\$31.28
14K Yellow or White	\$44.27	\$42.41	\$42.10
18K Yellow or White	\$55.31	\$53.45	\$53.14
.950/.05 Platinum/Ruthenium	\$77.95	\$76.92	\$76.81

STEPPED BEZEL STOCK

Bezel wire is available in 14kt gold and sterling silver.

Style	Thickness x Width x Height (mm)	Thickness x Width x Height (inches)	Approximate Pennyweights (dwt)	
			Per Square Inch 14K	Per Foot Sterling
Milgrain	0.29 x 1.08 x 2.5	.011 x .042 x .098	0.35	3.29
Plain Step	0.23 x 0.86 x 2.45	.009 x .034 x .096	0.27	2.18
Plain Step	0.27 x 0.78 x 5.56	.011 x .001 x .022	0.51	4.78

FLAT BEZEL STOCK	Approximate Pricing Per Pennyweight (dwt)		
	1 dwt	50 dwt	100 dwt
14K Yellow or White	\$44.27	\$42.41	\$42.10
Sterling Silver	\$1.84	\$1.63	\$1.62



Minimum order is 3 inches per size for gold. Sterling silver bezel wire is supplied in 1 foot increments (pieces), minimum order is 12 inches per size.

Item #1 Milgrain on Top Edge

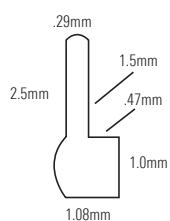

Item #2

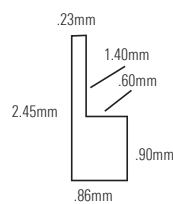

Item #3

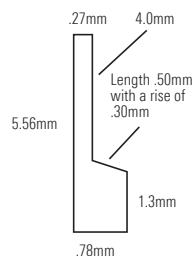

STULLER METALS CLUB

Call 877-619-2173 to join the Metals Club and start saving today.



Seamless Round Tubing is available in all sizes listed for 14kt yellow and 14kt palladium-white. Selected sizes are available in other qualities and supplied in straight lengths with a medium-hard temper.

Sterium Plus Round Tubing Round tubing available in 12" lengths only. Maximum order length is 24 inches. Same-day shipping subject to order specifications and inventory on hand at time of order. Sterling silver tubing is supplied in soft, straight, and stress-relieved.

GOLD ROUND TUBING

	Profile	Outside Diameter		Inside Diameter		Minimum Order	Approximate Pennyweights			Insert Wire (gauge)
		(mm)	(inch)	(mm)	(inch)		dwt (per inch) 14K	dwt (per inch) 18K	dwt (per foot) Sterium Plus	
Light .010" 30 ga	1 L	.039"	0.50	.020"	3"	0.13	0.16	1.15	25	
	1.13 L	.044"	0.63	.025"	3"	0.15	0.18	1.42	23	
	1.25 L	.049"	0.75	.030"	3"	0.13	0.21	1.54	21	
	1.43 L	.056"	0.93	.037"	1"	0.19	.228	1.82	20	
	1.6 L	.063"	1.10	.043"	1"	0.21	.252	2.18	18	
	1.8 L	.071"	1.30	.051"	1"	0.23	.288	2.51	17	
	2.05 L	.081"	1.55	.061"	1"	0.31	.372	2.92	15	
	2.25 L	.089"	1.75	.069"	1"	0.34	.408	3.25	14	
	2.55 L	.100"	2.05	.081"	1"	0.38	.456	3.53	13	
	2.85 L	.112"	2.35	.093"	1"	0.46	.552	4.00	12	
Medium .015" 26 ga	3.13 L	.123"	2.63	.103"	1"	0.48	0.60	4.65	10	
	2 M	.079"	1.20	.047"	1"	0.41	–	3.80	16	
	2.5 M	.098"	1.70	.067"	1"	0.53	0.60	4.80	14	
	3 M	.118"	2.20	.087"	1"	0.71	0.86	6.01	12	
	3.3 M	.130"	2.50	.098"	1"	0.75	–	7.50	11	
	3.56 M	.140"	2.76	.109"	12"	–	–	7.80	10	
	3.75 M	.148"	2.95	.116"	1"	0.88	1.06	7.45	9	
	4.06 M	.160"	3.26	.128"	12"	–	–	9.00	8	
	4.8 M	.189"	4.00	.157"	1"	1.09	1.31	11.38	7	
	5.08 M	.200"	4.28	.169"	12"	–	–	11.90	6	
Heavy .020" 24 ga	5.8 M	.228"	5.00	.197"	1"	1.38	1.66	12.45	5	
	6.09 M	.240"	5.29	.208"	12"	–	–	14.50	4	
	2 H	.079"	1.00	.039"	1"	0.49	0.59	4.85	19	
	2.25 H	.089"	1.25	.049"	1"	0.54	0.65	5.56	17	
	2.5 H	.098"	1.50	.059"	1"	0.64	0.77	5.30	15	
	2.85 H	.112"	1.85	.073"	1"	0.75	0.90	6.65	14	
	3.13 H	.123"	2.13	.084"	1"	0.87	1.06	8.30	12	
	3.5 H	.138"	2.50	.098"	1"	1.02	1.22	9.07	11	
	4 H	.157"	3.00	.118"	1"	1.23	1.48	11.02	9	
	4.25 H	.167"	3.25	.128"	1"	1.33	–	11.83	8	
Extra Heavy .025" 22 ga	4.5 H	.177"	3.50	.138"	1"	1.35	1.62	12.63	8	
	6.35 H	.250"	5.35	.211"	12"	–	–	19.20	–	
	5.1 X	.201"	3.83	.151"	1"	1.75	–	–	7	
	5.5 X	.217"	4.23	.167"	1"	–	2.27	–	6	
	6 X	.236"	4.73	.186"	1"	2.12	–	–	5	
	6.5 X	.256"	5.23	.206"	1"	2.52	–	–	3	

ROUND TUBING	Approximate Pricing Per Pennyweight (dwt)		
	1 dwt	50 dwt	100 dwt
14K Yellow	\$46.37	\$44.67	\$44.43
18K Yellow	\$57.41	\$55.71	\$55.47

SILVER ROUND TUBING	Approximate Pricing Per Pennyweight (dwt)/Ounce (oz)					
	1 dwt	1 oz	400 dwt	20 oz	1000 dwt	50 oz
Sterium Plus	\$10.11	\$202.20	\$9.34	\$186.80	\$9.08	\$181.60

Call 877-619-2173 to join the Metals Club and start saving today.





Wedding Band Fabrication and Design Made Seamless

Wedding bands mean big business. With more than two million weddings taking place every year, they double up to play a central role.

And with Stuller as your partner, you've got everything you need to establish your store as the place for bands. Now, you can purchase wedding bands at any step of the process.

We manufacture tubing and ring blanks here for use in our wedding band fabrication process. It starts with recycled grain. Then it is cast and drawn to the finger size needed. From this, ring blanks are cut to the widths specified.

From the stock bands that are ready to deliver profits to raw tubing and ring blanks to drive your

custom business, they are made from here from start to finish. And speaking of finishing, we can take it to whatever level you'd like. We can ship it raw, polish it, or add a special finish. The choice is yours. It's never been easier to create custom bands for your customers.

Metal qualities include:

Sterlium Plus™, 10K, 14K, and 18K gold.

Convenient ordering is available by millimeter size or inches with only a one millimeter minimum.

Finger Sizes:

3-3.5, 4-4.5, 5-5.5, 6-6.5, 7-7.5, 8-8.5, 9-9.5, 10-10.5, 11-11.5, and 12.

Minimum order: .048", 1.0mm minimum width

Maximum order: .64", 12.7mm maximum width



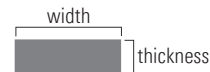

In order to determine what size best fits your needs, you must first measure the width, then the thickness.



SLIT COIL

Sterilium Plus slit coiled wire is supplied with a dead soft temper in continuous lengths. Larger orders may receive multiple coils.

Profile	Width x Thickness		Minimum Order	Approximate dwt/ft.	20 dwt (1 oz.) 100 dwt (5 oz.)		Approximate Price	
	(inch)	(mm)			Length (inch)	Length (ft)	1 dwt	100 dwt
	1/8" x .020"	3.18 x .51	36"	3.28	73"	30.48	\$1.57	\$1.54
	1/4" x .020"	6.35 x .51	24"	6.55	37"	15.27	\$1.57	\$1.54
	3/8" x .020"	9.52 x .51	12"	9.82	24"	10.18	\$1.57	\$1.54
	1/2" x .020"	12.70 x .51	12"	13.10	18"	7.63	\$1.57	\$1.54
	5/8" x .020"	15.88 x .51	12"	16.38	15"	6.11	\$1.57	\$1.54



FINE SILVER BEZEL

Flat bezel is supplied with a dead soft temper and coiled.

Profile	Shape	Gauge	Width x Thickness		Minimum Order	Approximate dwt/ft.	Approximate Price	
			(mm)	(inches)	(inches)		1 dwt	100 dwt
	Flat	30	4.76 x 0.255	1.8" x .016"	24"	.21	\$1.50	\$1.44
	Flat	30	3.18 x 0.255	1.8" x .016"	48"	.1389	\$1.50	\$1.44
	Flat	30	2.38 x 0.255	1.8" x .016"	60"	.1036	\$1.50	\$1.44
	Flat	28	4.76 x 0.321	1.8" x .016"	24"	.25	\$1.50	\$1.44
	Flat	28	3.18 x 0.321	1.8" x .016"	36"	.16	\$1.50	\$1.44
	Flat	28	2.38 x 0.321	1.8" x .016"	48"	.13	\$1.50	\$1.44
	Flat	26	3.18 x 0.405	1.8" x .016"	24"	.2207	\$1.50	\$1.44



STERLING SILVER DIAMOND-CUT WIRE

This amazing sterling silver wire sparkles just like a diamond-cut chain. Great for making earrings, neck wires, and more. Supplied in dead soft temper and coiled.

Profile	Gauge	Outside Diameter		Minimum Order	Approximate dwt/ft.	Approximate Price	
		(mm)	(inches)			1 dwt	100 dwt
	18	1.02	.04"	36"	1.68	\$1.35	\$1.30
	16	1.29	.05"	36"	2.28	\$1.35	\$1.30
	14	1.63	.06"	36"	3.38	\$1.35	\$1.30



















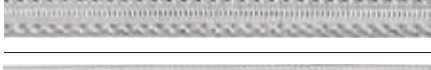

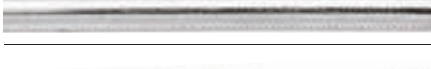



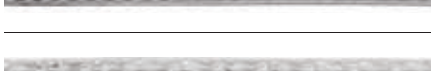















STERLING SILVER TWIST-WIRE

Twist wire is made by twisting round wire of the same diameter together. Supplied in dead soft temper and coiled.

Profile	Gauge	Outside Diameter		Minimum Order	Approximate dwt/ft.	Approximate Price	
		(mm)	(inches)			1 dwt	100 dwt
	18	1.02	.04"	60"	0.84	\$1.35	\$1.30
	14	1.63	.067"	36"	2.64	\$1.35	\$1.30
	12	2.05	.084"	24"	3.96	\$1.35	\$1.30
	10	2.58	.102"	12"	6.60	\$1.35	\$1.30

SILVER PATTERN WIRE

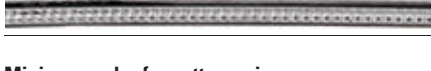
Sterling silver pattern wire is supplied soft and coiled.

	Profile	Style No.	Millimeter Width x Thickness	Approximate dwt (feet)	Approximate Price	
					1 dwt	100 dwt
		SS-210	7.63 x 1.24	13.80	\$1.35	\$1.30
		SS-211	4.13 x 1.35	8.40	\$1.35	\$1.30
		SS-212	4.7 x 1.5	9.00	\$1.35	\$1.30
		SS-213	5.35 x 1.47	11.76	\$1.35	\$1.30
		SS-214	5.67 x 1.33	10.80	\$1.35	\$1.30
		SS-215	2.4 x 1.45	4.80	\$1.35	\$1.30
		SS-216	2.04 x 1.28	3.84	\$1.35	\$1.30
		SS-217	2.85 x 1.5	6.00	\$1.35	\$1.30
		SS-218	2.42 x 1.27	4.44	\$1.35	\$1.30
		SS-219	1.55 x 1.35	3.36	\$1.35	\$1.30
		SS-240	2.6 x 0.55	2.20	\$1.35	\$1.30
		SS-242	3.67 x 1.1	7.44	\$1.35	\$1.30
		SS-244	6.45 x 0.88	7.20	\$1.35	\$1.30
		SS-245	6.35 x 1.58	14.16	\$1.35	\$1.30
		SS-246	3.54 x 1.4	7.68	\$1.35	\$1.30
		SS-247	3.45 x 1.35	7.20	\$1.35	\$1.30
		SS-249	19 x 0.87	31.39	\$1.35	\$1.30
		SS-250	9.55 x 1.3	24.00	\$1.35	\$1.30
		SS-402	5.6 x 2.6	11.88	\$1.35	\$1.30

Minimum order for pattern wire is 12 inches per size.

STULLER
METALS CLUB

Call 877-619-2173 to join the Metals Club and start saving today.



GOLD PLUMB SOLDER SHEET

CADMIUM-BEARING

These karat gold sheet solders contain cadmium to improve solder flow characteristics, and are supplied in one pennyweight sheets.

WARNING

Cadmium-bearing solders contain chemicals known to cause cancer, birth defects, and other health-related problems.

Solder Quality	Melting Point (°F)	Flow Point (°F)	Approximate Price Per Pennyweight (dwt)		
			1 dwt	50 dwt	100 dwt
6K Yellow, Easy	1165° F	1220° F	\$23.15	\$21.11	\$20.77
8K Yellow, Easy	1150° F	1230° F	\$28.56	\$26.52	\$26.18
10K Yellow, Easy	1170° F	1240° F	\$34.05	\$32.01	\$31.67
10K Yellow, Medium	1230° F	1285° F	\$34.05	\$32.01	\$31.67
10K Yellow, Hard	1310° F	1360° F	\$34.05	\$32.01	\$31.67
12K Yellow, Easy	1070° F	1165° F	\$39.40	\$37.36	\$37.02
14K Yellow, Ultra Easy	1070° F	1165° F	\$44.87	\$42.83	\$42.49
14K Yellow, Easy	1180° F	1320° F	\$44.87	\$42.83	\$42.49
14K Yellow, Medium	1230° F	1360° F	\$44.87	\$42.83	\$42.49
14K Yellow, Hard	1410° F	1460° F	\$44.87	\$42.83	\$42.49
18K Yellow, Easy	1155° F	1255° F	\$55.91	\$53.87	\$53.53
18K Yellow, Hard	1480° F	1550° F	\$55.91	\$53.87	\$53.53
21K Yellow, Hard	1545° F	1625° F	\$63.77	\$61.73	\$61.39
6K White, Easy	1220° F	1230° F	\$23.65	\$21.61	\$21.27
10K White, Easy	1250° F	1290° F	\$34.47	\$32.43	\$32.09
14K White, Easy	1235° F	1275° F	\$45.31	\$43.27	\$42.93
14K White, Hard	1330° F	1380° F	\$45.31	\$43.27	\$42.93
14K Red, Weld	1600° F	1690° F	\$45.33	\$43.29	\$42.95
18K Red, Medium	1395° F	1505° F	\$56.31	\$54.27	\$53.93
14K Green, Medium	1390° F	1425° F	\$45.58	\$43.54	\$43.20
18K Green, Medium	1510° F	1545° F	\$56.48	\$54.44	\$54.10

GOLD REPAIR SOLDER SHEET

CADMIUM-BEARING

Karat gold repair solders are lower in karat than the work for which they are recommended. Repair solders are easier flowing than our plumb solders and are an economical way to perform various solder tasks. Supplied in one pennyweight sheets.

WARNING

Cadmium-bearing solders contain chemicals known to cause cancer, birth defects, and other health related problems.

Solder Quality	Melting Point (°F)	Flow Point (°F)	Approximate Price Per Pennyweight (dwt)		
			1 dwt	50 dwt	100 dwt
14K Yellow, Easy	1170° F	1230° F	\$34.05	\$32.01	\$31.67
14K Yellow, Hard	1310° F	1360° F	\$34.05	\$32.01	\$31.67
18K White, Easy	1235° F	1275° F	\$45.31	\$43.27	\$42.93



100% Recycled Gold and Silver.
Visit Stuller.com/SensibleSourcing for more information.

See page 336 for all qualities available.	YELLOW	RED	WHITE	GREEN	.950 PLATINUM COBALT	STERLIUM PLUS
	10K 14K 18K	10K 14K 18K	10K 14K 14X1 18K	10K 14K 18K		

GOLD PLUMB SOLDER SHEET**CADMIUM-FREE**

These solders are cadmium-free and are offered in 1 dwt sheets. They are offered in standard karat golds and palladium.

Solder Quality	Melting Point (°F)	Flow Point (°F)	Approximate Price Per Pennyweight (dwt)		
			1 dwt	50 dwt	100 dwt
6K Yellow, Easy	1245° F	1300° F	\$23.15	\$21.11	\$20.77
8K Yellow, Easy	1210° F	1295° F	\$28.56	\$26.52	\$26.18
10K Yellow, Easy	1200° F	1345° F	\$34.05	\$32.01	\$31.67
10K Yellow, Medium	1260° F	1375° F	\$34.05	\$32.01	\$31.67
10K Yellow, Hard	1395° F	1430° F	\$34.05	\$32.01	\$31.67
12K Yellow, Easy	1210° F	1365° F	\$39.40	\$37.36	\$37.02
14K Yellow, Easy	1225° F	1335° F	\$44.87	\$42.83	\$42.49
14K Yellow, Medium	1300° F	1420° F	\$44.87	\$42.83	\$42.49
14K Yellow, Hard	1475° F	1500° F	\$44.87	\$42.83	\$42.49
18K Yellow, Easy	1300° F	1360° F	\$55.91	\$53.87	\$53.53
18K Yellow, Medium	1360° F	1405° F	\$55.91	\$53.87	\$53.53
18K Yellow, Hard	1440° F	1475° F	\$55.91	\$53.87	\$53.53
8K White, Easy	1345° F	1370° F	\$29.06	\$27.02	\$26.68
10K White, Easy	1240° F	1290° F	\$34.47	\$32.43	\$32.09
10K White, Hard	1305° F	1350° F	\$34.47	\$32.43	\$32.09
12K White, Easy	1270° F	1305° F	\$39.90	\$37.86	\$37.52
14K White, Easy	1235° F	1305° F	\$45.31	\$43.27	\$42.93
14K White, Medium	1335° F	1365° F	\$45.31	\$43.27	\$42.93
14K White, Hard	1450° F	1470° F	\$45.31	\$43.27	\$42.93
14K Palladium White, Hard	1370° F	1445° F	\$50.24	\$48.20	\$47.86
18K White, Easy	1330° F	1365° F	\$56.28	\$54.24	\$53.90
18K White, Hard	1490° F	1525° F	\$56.28	\$54.24	\$53.90
18K Palladium White, Hard	1750° F	1775° F	\$63.08	\$61.04	\$60.70
19K White, Weld	1635° F	1670° F	\$58.86	\$56.82	\$56.48
20K White, Weld	1570° F	1600° F	\$61.79	\$59.75	\$59.41
14K Red, Medium	1564° F	1565° F	\$45.22	\$43.18	\$42.84
14K Red, Hard	1569° F	1571° F	\$45.22	\$43.18	\$42.84

**GOLD REPAIR SHEET****CADMIUM-FREE**

Karat gold repair solders flow easier than our plumb solders and are an economical way to perform various soldering tasks. These solders are lower in karat than the work for which they are recommended.

Sold in 1 pennyweight sheets.

Solder Quality (Repair)	Gold Content	Melting Point (°F)	Flow Point (°F)	Approximate Price Per Pennyweight (dwt)		
				1 dwt	50 dwt	100 dwt
14K Yellow, Easy	10kt	1200° F	1345° F	\$34.05	\$32.01	\$31.67
14K Yellow, Hard	10kt	1395° F	1430° F	\$34.05	\$32.01	\$31.67
14K White, Easy	10kt	1240° F	1290° F	\$34.47	\$32.43	\$32.09
14K White, Hard	10kt	1305° F	1350° F	\$34.47	\$32.43	\$32.09

LEAD TIMES: 10K yellow, 14K yellow, 14K white, 18K yellow and sterling silver will ship same day in most cases. Back orders will ship the following day. All other metal qualities are MTO (made to order) and will ship within three working days in most cases. Same-day shipping subject to order specifications, special request, and inventory on hand at time of order. Additional charges and lead times may apply to odd quantities.

STULLER
METALS CLUB

Call **877-619-2173** to join the Metals Club and start saving today.

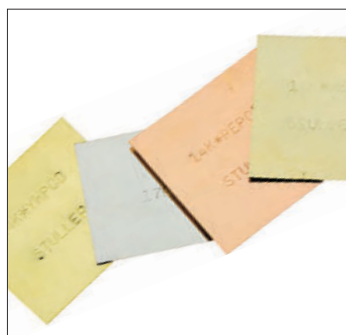

COLOR-MATCH SHEET GOLD PLUMB SOLDER

CADMIUM-FREE This solder is currently used in our day-to-day manufacturing. Our karat gold color match solders provide excellent soldering characteristics as they were formulated to match the color of our karat gold shanks, findings, mountings, and mill products. Each solder quality has been extensively tested in-house for color match, flow, and polishing characteristics.

Solder Quality	Melting Point (°F)	Flow Point (°F)	Approximate Price Per Pennyweight (dwt)		
			1 dwt	50 dwt	100 dwt
14K Yellow, Easy	1270° F	1280° F	\$44.87	\$42.83	\$42.49
14K Yellow, Medium	1375° F	1430° F	\$44.87	\$42.83	\$42.49
14K Yellow, Hard	1450° F	1480° F	\$44.87	\$42.83	\$42.49
18K Yellow, Medium	1345° F	1460° F	\$55.91	\$53.87	\$53.53
10K White, Easy	1255° F	1260° F	\$34.47	\$32.43	\$32.09
14K White, Easy	1305° F	1330° F	\$45.31	\$43.27	\$42.93
14K White, Hard	1445° F	1500° F	\$45.31	\$43.27	\$42.93
14K X1 White, Easy	1300° F	1330° F	\$45.66	\$43.62	\$43.28
14K X1 White, Medium	1350° F	1390° F	\$45.66	\$43.62	\$43.28
18K White, Hard	1475° F	1530° F	\$56.28	\$54.24	\$53.90



PLATINUM PLUMB SOLDER SHEET

CADMIUM-FREE Plumb platinum solders provide a superior white color as compared to traditional solders for platinum work. Because of the higher platinum content (90% to 95%), the color is nearly a perfect match with most platinum alloys. Polishing problems are also reduced as the hardness of these solders closely matches the surrounding platinum alloy. *Supplied in 1/2 dwt sheets.

Solder Quality	Platinum Content	Melting Point (°F)	Flow Point (°F)	1/2 dwt	1 dwt	50 dwt
Easy, Plumb	90%	1300° F	2372° F	\$12.66	\$45.37	\$44.21
Medium, Plumb	92.5%	1400° F	2552° F	\$12.66	\$45.37	\$44.21
Hard, Plumb	95%	1500° F	2732° F	\$12.66	\$45.37	\$44.21



PLATINUM REPAIR SOLDER SHEET

CADMIUM-FREE Solders for platinum are supplied in one pennyweight sheets. Prices are approximate and will fluctuate with platinum, palladium, gold, and silver markets.

Solder For Platinum (°C)	Platinum Content	Melting Point (°F)	Flow Point (°F)	Approximate Price Per Pennyweight (dwt)		
				1 dwt	50 dwt	100 dwt
1000° C Extra Easy	5%	1915° F	1932° F	\$37.49	\$36.04	\$35.88
1100° C Easy	0%	2080° F	2112° F	\$44.85	\$43.41	\$43.25
1200° C Medium	3%	2185° F	2292° F	\$57.42	\$55.98	\$55.82
1300° C Hard	0%	2372° F	2472° F	\$71.70	\$70.25	\$70.09
1400° C Extra Hard	5%	2552° F	2652° F	\$69.95	\$68.50	\$68.34
1500° C Weld	0%	2732° F	2832° F	\$69.70	\$68.25	\$68.09
1600° C Special Weld	7.5%	2912° F	3012° F	\$58.15	\$56.70	\$56.54
1700° C Seamless	70%	3092° F	3192° F	\$70.25	\$68.80	\$68.64
1773° C Weld	100%	3224° F	3324° F	\$80.70	\$79.25	\$79.09



SILVER SOLDER SHEET

CADMIUM-FREE Silver sheet solder supplied in 1 pennyweight sheets.

Solder Quality	Silver Content	Melting Point (°F)	Flow Point (°F)	Approximate Price	
				1 dwt	100 dwt
Silver, Easy	60%	1160° F	1285° F	\$2.43	\$2.33
Silver, Medium	70%	1300° F	1335° F	\$2.43	\$2.33
Silver, Hard	80%	1410° F	1420° F	\$2.43	\$2.33

GOLD PLUMB SOLDER CHIPPED

CADMIUM-BEARING

This karat gold chipped solder contains cadmium and is pre-cut to .045"-.045".

WARNING
Cadmium-bearing solders contain chemicals known to cause cancer, birth defects, and other health related problems.



Solder Quality	Melting Point (°F)	Flow Point (°F)	Approximate Price Per Pennyweight (dwt)		
			1 dwt	50 dwt	100 dwt
10K Yellow, Easy	1170° F	1230° F	\$37.05	\$35.01	\$34.67
14K Yellow, Ultra Easy	1070° F	1165° F	\$47.87	\$45.83	\$45.49
14K Yellow, Easy	1180° F	1320° F	\$47.87	\$45.83	\$45.49
14K Yellow, Hard	1410° F	1460° F	\$47.87	\$45.83	\$45.49
10K White, Easy	1250° F	1290° F	\$37.47	\$35.43	\$35.09
14K White, Easy	1235° F	1270° F	\$48.31	\$46.27	\$45.93
14K White, Hard	1330° F	1380° F	\$48.31	\$46.27	\$45.93
14K Red, Weld	1600° F	1690° F	\$49.83	\$47.79	\$47.45

GOLD PLUMB SOLDER CHIPPED

CADMIUM-FREE

This karat gold chipped solders are cadmium-free and are pre-cut to .045" x .045".

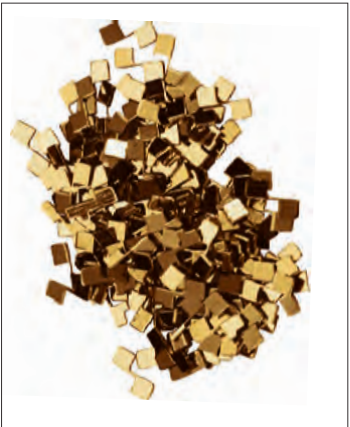

Solder Quality	Melting Point (°F)	Flow Point (°F)	Approximate Price Per Pennyweight (dwt)		
			1 dwt	50 dwt	100 dwt
10K Yellow, Easy	1200° F	1345° F	\$37.05	\$35.01	\$34.67
10K Yellow, Hard	1395° F	1430° F	\$37.05	\$35.01	\$34.67
14K Yellow, Easy	1225° F	1335° F	\$47.87	\$45.83	\$45.49
14K Yellow, Medium	1300° F	1420° F	\$47.87	\$45.83	\$45.49
14K Yellow, Hard	1475° F	1500° F	\$47.87	\$45.83	\$45.49
14K White, Easy	1235° F	1305° F	\$48.31	\$46.27	\$45.93
14K White, Medium	1335° F	1365° F	\$48.31	\$46.27	\$45.93
14K White, Hard	1450° F	1470° F	\$48.31	\$46.27	\$45.93
18K White, Hard	1490° F	1525° F	\$56.28	\$54.24	\$53.90
19K White, Weld	1635° F	1670° F	\$61.86	\$59.82	\$59.48

SILVER CHIPPED SOLDER

CADMIUM-FREE

Silver chipped solder is supplied in convenient pre-cut 1 mm squares.



Solder Quality	Silver Content	Melting Point (°F)	Flow Point (°F)	Approximate Price	
				1 dwt	100 dwt
Silver, Easy	65%	1230° F	1285° F	\$2.53	\$2.42
Silver, Medium	70%	1300° F	1335° F	\$2.53	\$2.42
Silver, Hard	75%	1410° F	1420° F	\$2.53	\$2.42

See page 336 for all qualities available.	YELLOW	RED	WHITE	GREEN	.950 PLATINUM COBALT	STERLIUM PLUS
	10K	10K	10K	10K		
	14K	14K	14K	14K		
	18K	18K	14X1 18K	18K		

STULLER METALS CLUB

Call 877-619-2173 to join the Metals Club and start saving today.



GOLD PLUMB SOLDER WIRE
CADMIUM-BEARING

WARNING
Cadmium-bearing solders contain chemicals known to cause cancer, birth defects, and other health related problems.

Solder Quality	Gauge	Melting Point (°F)	Flow Point (°F)	Approximate Price Per Pennyweight (dwt)		
				1 dwt	50 dwt	100 dwt
14K Yellow,Ultra Easy	24	1070° F	1165° F	\$44.87	\$42.83	\$42.49
14K Yellow,Ultra Easy	30	1070° F	1211° F	\$44.87	\$42.83	\$42.49
14K Yellow,Easy	24	1080° F	1320° F	\$44.87	\$42.83	\$42.49



SILVER SOLDER WIRE
CADMIUM-FREE

Easy and medium silver solder wire supplied in 20 gauge only.
Hard silver solder wire is supplied in 20 gauge and 28 gauge.

Solder Quality	Gauge	Silver Content	Melting Point (°F)	Flow Point (°F)	Approximate Price	
					1 dwt	100 dwt
Silver, Easy	20	56%	1160° F	1285° F	\$1.33	\$1.28
Silver, Medium	20	70%	1300° F	1335° F	\$1.33	\$1.28
Silver, Hard	20	80%	1410° F	1420° F	\$1.33	\$1.28
Silver, Hard	28	80%	1410° F	1420° F	\$1.33	\$1.28
Continuum® Sterling Silver, Medium	20	84%	1350° F	1550° F	\$2.36	\$2.32
Continuum® Sterling Silver, Hard	20	86%	1470° F	1600° F	\$2.48	\$2.43

Minimum order is 5 feet (approximately 5 pennyweights) per quality.



SILVER SOLDER STRIP
CADMIUM-FREE

Supplied in convenient 12" x .016" strips. Each silver strip weighs approximately five pennyweights.
Minimum order is one strip per quality.

Solder Quality	Silver Content	Melting Point (°F)	Flow Point (°F)	Approximate Price	
				1 dwt	100 dwt
Silver, Easy	56%	1230° F	1285° F	\$9.82	\$9.31
Silver, Medium	70%	1300° F	1335° F	\$9.82	\$9.31
Silver, Hard	75%	1410° F	1420° F	\$9.82	\$9.31

Solder Tip

When soldering, wear protective goggles with a shade number of at least four to protect against infrared radiation. They should be approved by the American National Standards Institute (ANSI). Full-faced shields are also available to protect the face. Use leather protective gloves to handle hot metals.



100% Recycled Gold and Silver.
Visit Stuller.com/SensibleSourcing for more information.

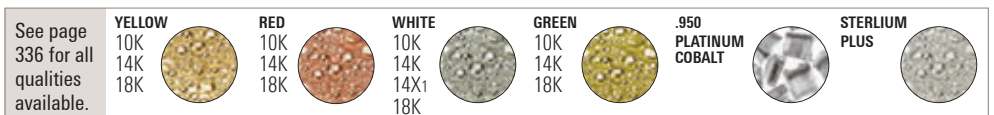

GOLD PASTE SOLDER**CADMIUM-FREE**

Our paste solder is packaged in a syringe that contains one pennyweight of gold solder and flux. This paste is excellent for chain repair and fine detail work due to the special formula that leaves little or no carbon residue, providing clean, bright assemblies. It is compatible with our paste solder hand applicator.

Solder Quality	Solder Type	Melting Point (°F)	Flow Point (°F)	Approximate Price Per Pennyweight (dwt)		
				1 dwt	20 dwt	50 dwt
1K Yellow Gold Filled	Plumb	1135° F	1170° F	\$9.51	\$7.81	\$7.47
6K Yellow	Repair	1110° F	1295° F	\$23.15	\$21.45	\$21.11
10K Yellow Easy	Plumb	1195° F	1290° F	\$34.05	\$32.35	\$32.01
10K Yellow Medium	Plumb	1293° F	1375° F	\$34.05	\$32.35	\$32.01
10K Yellow Hard	Plumb	1395° F	1450° F	\$34.05	\$32.35	\$32.01
14K Yellow Easy	Plumb	1185° F	1330° F	\$44.87	\$43.17	\$42.83
14K Yellow Medium	Plumb	1330° F	1390° F	\$44.87	\$43.17	\$42.83
14K Yellow Hard	Plumb	1400° F	1440° F	\$44.87	\$43.17	\$42.83
18K Yellow Easy	Plumb	1270° F	1320° F	\$55.91	\$54.21	\$53.87
6K White	Repair	1120° F	1315° F	\$23.15	\$21.45	\$21.11
10K White Easy	Plumb	1130° F	1260° F	\$33.97	\$32.27	\$31.93
10K White Medium	Plumb	1200° F	1320° F	\$33.97	\$32.27	\$31.93
10K White Hard	Plumb	1340° F	1450° F	\$33.97	\$32.27	\$31.93
14K White Easy	Plumb	1160° F	1280° F	\$44.81	\$43.11	\$42.77
14K White Medium	Plumb	1325° F	1405° F	\$44.81	\$43.11	\$42.77
14K White Hard	Plumb	1335° F	1445° F	\$44.81	\$43.11	\$42.77
14K X1® White Ultra Easy	Plumb	1040° F	1280° F	\$45.16	\$43.46	\$43.12

**SILVER PASTE SOLDER****CADMIUM-FREE**

Silver paste solder is powdered and mixed with the proper proportion of flux, and packaged in convenient, disposable syringes. Specially formulated binders assure that little or no carbon residue is left on the joint when soldering. Each syringe contains three pennyweights of silver solder and flux, and is designed to work in our new paste solder hand applicator.

Solder Quality	Silver Content	Melting Point (°F)	Flow Point (°F)	Approximate Per Syringe 3 dwt
Silver, Extra Easy	56%	1140° F	1205° F	\$4.77
Silver, Easy	65%	1240° F	1325° F	\$4.77
Silver, Medium	70%	1275° F	1360° F	\$4.77
Silver, Hard	75%	1365° F	1450° F	\$4.77

MK3 PASTE SOLDER DISPENSER

Manual solder dispenser designed to deposit paste solders with pinpoint accuracy. Use with Stuller paste solders syringes.

Order #	Description	12+	6+	1+
54-4010	MK3 Solder Dispenser	\$23.76	\$25.16	\$27.95



Paste sold separately

STULLER
METALS CLUB

Call **877-619-2173** to join the Metals Club and start saving today.



ROUND

Order # 30000
Quality 14K Yellow Gold

mm OD	4.76	6.35	7.94	8.73	9.53	11.11	12.7	13.49	14.29	15.88
Inches (OD)	3/16"	1/4"	5/16"	1/2"	3/8"	7/16"	1/2"	17/32"	9/16"	5/8"
Pennyweights (dwt)	0.12	0.22	0.33	0.40	0.48	0.65	0.85	0.96	1.05	1.35
14K Yellow \$	\$6.42	\$11.90	\$17.50	\$21.21	\$25.45	\$34.55	\$45.10	\$50.77	\$55.56	\$71.65

mm OD	17.46	19.05	20.64	22.23	23.81	25.4	26.99	28.58	30.16	31.75
Inches (OD)	11/16"	3/4"	13/16"	7/8"	15/16"	1"	11/16"	1 1/8"	1 1/16"	1 1/4"
Pennyweights (dwt)	1.59	1.91	2.29	2.64	3.79	3.47	3.89	4.35	4.85	5.32
14K Yellow \$	\$84.18	\$101.29	\$121.55	\$139.73	\$200.79	\$184.08	\$206.10	\$230.71	\$256.91	\$282.01

mm OD	33.34	34.93	38.1	41.28	44.45	47.63	50.8	57.15	63.5
Inches (OD)	1 5/16"	1 3/8"	1 1/2"	1 5/8"	1 3/4"	1 7/8"	2"	2 1/4"	2 1/2"
Pennyweights (dwt)	5.93	6.40	7.66	9.10	10.23	11.84	13.58	17.17	21.20
14K Yellow \$	\$314.39	\$339.13	\$405.99	\$482.38	\$542.36	\$627.72	\$720.10	\$910.41	\$1,123.96



ROUND, UNDRILLED EYELET

Order # 30000
Quality 14K Yellow Gold

mm OD	8	9.5	11	13.5	14.25	16	17.5	19	20.75	22.25
Pennyweights (dwt)	0.35	0.53	0.67	0.98	1.15	1.42	1.65	2.09	2.50	2.64
14K Yellow \$	\$18.56	\$28.33	\$35.54	\$51.84	\$60.82	\$75.35	\$87.60	\$110.58	\$132.46	\$140.09

mm OD	23.75	25.25	26	27.25	30	41.25	44.25
Pennyweights (dwt)	3.08	3.41	3.60	3.89	4.80	9.06	10.38
14K Yellow \$	\$163.29	\$180.70	\$190.94	\$206.34	\$254.27	\$480.44	\$550.32



LONG OVAL

Order # 30005
Quality 14K Yellow Gold

mm OD	11 x 5	12.5 x 6.75	19 x 7.75	20.5 x 10.75	24.5 x 12.75	26 x 9.5	42 x 20
Pennyweights (dwt)	0.28	0.45	0.77	1.91	1.68	1.32	4.31
14K Yellow \$	\$14.65	\$23.88	\$40.96	\$63.31	\$89.07	\$69.98	\$228.28



100% Recycled Gold and Silver.
Visit Stuller.com/SensibleSourcing
for more information.

See page 336 for all qualities available.	YELLOW 10K 14K 18K	RED 10K 14K 18K	WHITE 10K 14K 14X1 18K	GREEN 10K 14K 18K	.950 PLATINUM COBALT	STERLIUM PLUS
---	------------------------------------	---------------------------------	---	-----------------------------------	-----------------------------	----------------------

Prices for stampings are based on 20 gauge.

Prices based on \$1,300 gold, \$1,400 platinum, \$900 palladium and \$18 silver.

OVAL

Order # 30005

Quality 14K Yellow Gold



mm OD	8.25 × 6.75	11 × 9	12.75 × 11.25	13.5 × 9.25	17.25 × 12.75	18.25 × 11.25	18.25 × 13.75
Pennyweights (dwt)	0.30	0.51	0.77	0.68	1.14	1.12	1.36
14K Yellow \$	\$15.91	\$27.23	\$40.82	\$36.05	\$60.17	\$59.23	\$72.17

mm OD	18.75 × 15.5	19 × 12.25	22 × 15.25	26.5 × 19.5	31.75 × 25.5	37 × 31	38.25 × 29
Pennyweights (dwt)	1.51	1.22	1.74	2.77	4.30	6.11	5.87
14K Yellow \$	\$80.23	\$64.84	\$92.10	\$146.96	\$228.11	\$324.15	\$311.42

OVAL, SMALL UNDRILLED EYELET

Order # 30005

Quality 14K Yellow Gold



mm OD	19.75 × 16.25	26 × 16	28.25 × 21.25	32 × 25.5
Pennyweights (dwt)	1.78	2.27	3.19	4.37
14K Yellow \$	\$94.59	\$120.57	\$169.00	\$231.74

OVAL, SMALL UNDRILLED EYELET

Order # 30005

Quality 14K Yellow Gold



mm OD	28.5 × 21	31.75 × 23
Pennyweights (dwt)	3.33	3.98
14K Yellow \$	\$176.75	\$210.83

SQUARE

Order # 30006

Quality 14K Yellow Gold



mm OD	9.75 × 9.75	12.75 × 12.75	14 × 14	16.25 × 16.25
Pennyweights (dwt)	0.63	1.10	1.32	1.68
14K Yellow \$	\$33.58	\$58.45	\$69.72	\$89.07

mm OD	17 × 17	19.25 × 19.25	22.25 × 22.25	28.75 × 28.75
Pennyweights (dwt)	1.97	2.49	3.31	5.41
14K Yellow \$	\$104.36	\$131.80	\$175.40	\$286.69

SQUARE, UNDRILLED EYELET

Order # 30006

Quality 14K Yellow Gold



mm OD	17.5 × 17.5	22.5 × 22.25	28.75 × 28.75
Pennyweights (dwt)	2.08	3.43	5.66
14K Yellow \$	\$110.28	\$181.58	\$299.81

Note: Stampings are also available in sterling silver. Special orders requesting sterling silver require a minimum order quantity and additional lead times.

STULLER
METALS CLUB

Call **877-619-2173** to join the Metals Club and start saving today.



RECTANGLE

Order # 30003
Quality 14K Yellow Gold

mm OD	8.5 × 5.5	13 × 11	17 × 11.75	19.25 × 12.75	19.25 × 16.25
Pennyweights (dwt)	0.31	0.96	1.32	1.62	1.98
14K Yellow \$	\$16.44	\$50.79	\$70.17	\$85.96	\$105.11
mm OD	20.75 × 16.75	22.5 × 18.5	25.5 × 22.25	28.75 × 23.25	32.75 × 27
Pennyweights (dwt)	2.34	2.78	3.73	4.52	5.86
14K Yellow \$	\$124.06	\$147.30	\$197.89	\$239.43	\$310.74



LONG RECTANGLE, UNDRILLED EYELET

Order # 30003
Quality 14K Yellow Gold

mm OD	13.75 × 6.5	19.25 × 16.25	22.25 × 9.5	27 × 22.25
Pennyweights (dwt)	0.62	2.18	1.52	4.13
14K Yellow \$	\$32.78	\$114.96	\$80.46	\$219.18



RECTANGLE, ROUND EDGE & UNDRILLED EYELET

Order # 30003
Quality 14K Yellow Gold

mm OD	20.5 × 16.25	21.5 × 14.25	37.5 × 28.25
Pennyweights (dwt)	2.54	2.19	7.20
14K Yellow \$	\$119.50	\$115.90	\$381.59



RECTANGLE, UNDRILLED EYELET

Order # 30003
Quality 14K Yellow Gold

mm OD	14.25 × 19	17.5 × 22	19.25 × 22.5	19.5 × 25.5	21 × 27
Pennyweights (dwt)	1.84	2.64	2.95	3.40	3.90
14K Yellow \$	\$97.55	\$139.86	\$156.17	\$180.41	\$206.63
mm OD	22.25 × 25.5	24 × 32	26.25 × 32	29.75 × 32.5	
Pennyweights (dwt)	3.79	5.23	5.6433	6.585	
14K Yellow \$	\$200.93	\$277.28	\$299.19	\$349.12	



RECTANGLE ROUND EDGE

Order # 30003
Quality 14K Yellow Gold

mm OD	18.25 × 13.5	22.25 × 18	22.25 × 19.5	22.5 × 11.25
Pennyweights (dwt)	1.59	1.68	2.67	2.85
14K Yellow \$	\$84.38	\$141.50	\$150.97	\$88.96



DIAMOND-SHAPE UNDRILLED EYELET

Order # 30001
Quality 14K Yellow Gold

mm OD	13 × 13	14 × 14	16 × 16	17 × 17	19 × 19	25.5 × 25.5	28 × 28
Pennyweights (dwt)	1.1533	1.3233	1.755	2.035	2.4827	4.3137	5.54
14K Yellow \$	\$61.14	\$70.16	\$93.05	\$107.89	\$131.63	\$228.70	\$293.71



100% Recycled Gold and Silver.
Visit Stuller.com/SensibleSourcing for more information.

See page 336 for all qualities available.	YELLOW 10K 14K 18K	RED 10K 14K 18K	WHITE 10K 14K 14X1 18K	GREEN 10K 14K 18K	.950 PLATINUM COBALT	STERILUM PLUS
---	------------------------------------	---------------------------------	---	-----------------------------------	-----------------------------	----------------------

Prices for stampings are based on 20 gauge.

Prices based on \$1,300 gold, \$1,400 platinum, \$900 palladium and \$18 silver.

mm OD	20.25 × 20.25	31.75 × 31.75
Pennyweights (dwt)	2.24	5.56
14K Yellow \$	\$118.49	\$294.51

OCTAGON

Order # 30004
Quality 14K Yellow Gold



mm OD	20 × 20	24.25 × 24.5	27 × 27	31.75 × 32
Pennyweights (dwt)	2.31	3.32	4.09	5.48
14K Yellow \$	\$122.68	\$176.10	\$216.97	\$290.64

OCTAGON, UNDRILLED EYELET

Order # 30004
Quality 14K Yellow Gold



mm OD	14.25 × 12.25	15.5 × 12	16.5 × 15
Pennyweights (dwt)	1.06	1.10	1.47
14K Yellow \$	\$56.11	\$58.32	\$77.85

LONG OCTAGON

Order # 30004
Quality 14K Yellow Gold



mm OD	27.5 × 27.5	32 × 31.75	36 × 26.5
Pennyweights (dwt)	4.64	5.43	6.05
14K Yellow \$	\$320.75	\$245.77	\$287.83

LONG OCTAGON UNDRILLED EYELET

Order # 30004
Quality 14K Yellow Gold



TEARDROP

Order # 30007
Quality 14K Yellow Gold

mm OD	11.5 × 8	14 × 8.5	17.75 × 11.25	19 × 13	32.75 × 21.5	36.25 × 24.75
Pennyweights (dwt)	0.42	0.50	0.93	1.18	3.30	4.37
14K Yellow \$	\$22.37	\$26.43	\$49.31	\$62.48	\$174.74	\$231.82



LEAD TIMES: 10kt yellow, 14kt yellow, 14kt white, 18kt yellow, and sterling silver will ship same day in most cases. Back orders will ship the following day. All other metal qualities are MTO (made to order) and will ship within three working days in most cases. Same day shipping subject to order specifications, special request and inventory on hand at time of order. Additional charges and lead times may apply to odd quantities. Note: Stampings are also available in sterling silver. Special orders requesting sterling silver do require a minimum order quantity and additional lead times.

Note: Stampings are also available in sterling silver. Special orders requesting sterling silver require a minimum order quantity and additional lead times.

STULLER METALS CLUB

Call 877-619-2173 to join the Metals Club and start saving today.

Stampings



TRIANGLE

Order # 30008

Quality 14K Yellow Gold

mm OD	20.75 × 24	27.5 × 25.5	33 × 38
Pennyweights (dwt)	2.14	2.41	4.13
14K Yellow \$	\$113.40	\$127.57	\$218.96

HEART

Order # 30002

Quality 14K Yellow Gold



mm OD	5 × 5	6.5 × 6.75	8 × 8
Pennyweights (dwt)	0.11	0.21	0.34
14K Yellow \$	\$5.85	\$11.13	\$17.94

mm OD	10 × 10	13 × 12	17 × 15
Pennyweights (dwt)	0.46	0.75	1.15
14K Yellow \$	\$24.52	\$39.90	\$61.11

mm OD	20 × 19.25	31 × 31	39.5 × 39.25
Pennyweights (dwt)	1.77	4.50	7.77
14K Yellow \$	\$93.91	\$238.75	\$411.68

HEART, UNDRILLED EYELET

Order # 30002

Quality 14K Yellow Gold



mm OD	6.75 × 6.75*	7.5 × 5.5	10 × 9.25	12.75 × 13.25
Pennyweights (dwt)	0.09	0.20	0.42	0.8
14K Yellow \$	\$4.77	\$10.39	\$22.27	\$45.04

* Available in 30 gauge only.

mm OD	18.25 × 18.75	20 × 19.25	21.5 × 20.5	26 × 24.25
Pennyweights (dwt)	1.73	1.86	2.18	3.13
14K Yellow \$	\$91.56	\$98.65	\$115.58	\$165.90

mm OD	30.75 × 31	33.75 × 31	36.75 × 36	40 × 39.5
Pennyweights (dwt)	4.54	5.22	6.53	7.62
14K Yellow \$	\$240.85	\$276.57	\$345.94	\$404.12



3398

7.25 × 17.5

0.76 dwt

14K Yellow \$40.03



3133

8 × 23

0.93 dwt

14K Yellow \$49.31



3297

6.25 × 19.25

0.24 dwt

14K Yellow \$12.72



3390

5.25 × 24.5

0.89 dwt

14K Yellow \$47.26



3397

5.25 × 33

1.22 dwt

14K Yellow \$64.53



3396

7 × 39

1.86 dwt

14K Yellow \$99.45

Available in 30 gauge only.



Prices for stampings are based on 20 gauge.

Prices based on \$1,300 gold, \$1,400 platinum, \$900 palladium and \$18 silver.



100% Recycled Gold and Silver.
Visit Stuller.com/SensibleSourcing
for more information.



3291
32.25
5/09 dwt
14K Yellow \$270.28



3385
21.25
2.38 dwt
14K Yellow \$126.33



3382
21.5
2.40 dwt
14K Yellow \$127.18



3251
24 x 19
2.32 dwt
14K Yellow \$122.93



3252
29 x 23.5
3.42 dwt
14K Yellow \$181.40



3732
14.5 x 12.5
0.95 dwt
14K Yellow \$50.55



3733
15.25 x 14
1.05 dwt
14K Yellow \$55.63



3736
21.75 x 19.25
2.05 dwt
14K Yellow \$108.88



3737
22.5 x 20
2.33 dwt
14K Yellow \$123.37



3787
14 x 12.5
0.95 dwt
14K Yellow \$50.23



3161
31 x 20.5
2.61 dwt
14K Yellow \$138.40



3734
18.75 x 17.5
1.54 dwt
14K Yellow \$81.67



3742
21 x 17.75
1.98 dwt
14K Yellow \$105.00



3739
21.25 x 19.25
2.22 dwt
14K Yellow \$117.54



3904
28.75 x 50.75
8.77 dwt
\$464.43

* Chain sold separately.



3395
28.75 x 50.75
8.95 dwt
14K Yellow \$474.24



3902
28.75 x 50.75
8.62 dwt
14K Yellow \$457.01

You are behind your sales counter when one of your repeat customers enters your store. One look at her immediately warns you that something is very wrong. After a short greeting, the customer produces a piece of jewelry that has missing prong tips, and, even worse, the diamond or gemstone is also missing. After a few questions and a quick visual examination, it becomes obvious that this is not the typical fracture as seen when a prong has been torn off. Closer inspection of the fracture surface reveals a grainy appearance that is very porous. The odd appearance of the fracture surface and the infrequency of this type of failure lead you to believe that the problem is “bad metal” or “bad casting.” Was the problem really due to defective metal or casting, or is there another explanation and solution? The correct answer may surprise even the most skilled and experienced craftsman.

It is not surprising to initially blame the material as the cause of fracture, but, with the use of high-powered magnification and literature that is not readily available to the craftsman, the real cause can be found. The photos below illustrate several products with a “mysterious” failure that you may have encountered during your career. The prong tips broke off with little or no indication of onset of failure. As a matter of fact, they all appear to have fractured in a brittle manner showing very little ductility.

All of the examples in the photos below (A-B) illustrate that none of the failed prongs exhibit evidence of ductility around the broken prong tip or on the fracture surface. Features like “orange peel” texture or a dimpled fracture surface are always present when a ductile alloy has been broken by bending, twisting or pulling too many times. Most karat gold alloys typically used to produce jewelry are usually quite ductile. You are able to bend each of the prongs to correctly seat the stone with no obvious complications.



This lack of ductility becomes very clear when the fracture surface of the broken prong tips are viewed under high magnification using a scanning electron microscope (SEM). The black and white photos seen below (C-D) are SEM images taken at lower magnifications, typically 20X to 100X. At higher magnifications, the fracture surfaces appear as shown in the SEM images on the following page.

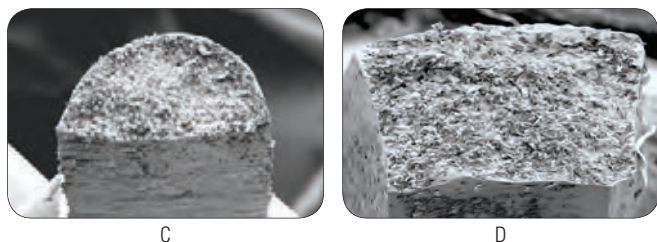

The “rock candy” appearances of grains in these images are merely facets of grain boundaries. Each grain has separated from its neighbors along the grain boundaries it once shared with them. This is known as intergranular fracture, which is typically associated with the brittle mode of failure. The brittle fracture surface often appears specular or shiny (when it is not covered with debris) to the unaided eye. At low magnification, the intergranular fracture surface may appear porous (E). At higher magnification (F), it becomes apparent that the pockets are created by clusters of crystals being removed at multiple levels. This intergranular fracture is clear

evidence of how the initially ductile gold alloys used in jewelry applications have become brittle at the notched areas of the prong tip.

So, why did the prong fail in a brittle manner? Brittle mode failure of a ductile gold alloy is not typical. The three most common causes of brittle mode failure are stress corrosion, hot tearing and contamination of the alloy.

Hot tearing typically results in intergranular failure and occurs when stress is applied to the material at elevated temperatures near its melting point. These fractures usually exhibit oxidation on the fracture surface and a “waxy” appearance on the crystal facets. Examples of hot tearing would be fractures occurring during soldering operations and fractures found on castings due to fast quenching of investment molds. If these type fractures are present in a prong they would usually become obvious when the prong was manipulated during stone setting.

Gross contamination of gold alloys can also lead to intergranular fracture. Lead is a well documented contaminant in gold alloys and levels as little as 0.01% can result in brittle failure. Alloys with gross contamination would almost never make it through stressful operations such as rolling, drawing or stone setting without suffering severe cracking.

Stress corrosion cracking (SCC) is a brittle mode failure that is well documented and has been extensively studied in all families of different engineering alloys. For example, certain types of stainless steel are known to be susceptible to SCC when exposed to chlorine or chlorine containing compounds. Copper alloys such as brass or bronze are susceptible to SCC when exposed to ammonia.

Elements that are known to promote SCC of gold jewelry alloys can be found in the halogen group. These corrosive elements include iodine, chlorine, fluorine, and bromine. For a karat gold jewelry piece to suffer SCC, two factors must be present and act simultaneously - residual stress (prong tension, etc...) and exposure to a corrosive environment. The jewelry will not fail due to SCC if either one of the components is absent.

Residual stresses remain in a metal after it is deformed. Operations such as bending, stretching, and compression are known sources of residual stresses. Increasing the level of residual stress also increases the chances of failure when exposed to a corrosive environment. Residual stress can be reduced or eliminated by either annealing or by using a low-temperature, stress-relieving, heat treatment cycle. The low-temperature treatment is preferred when stones or solder joints are involved and requires holding the jewelry at 650° F for one hour.

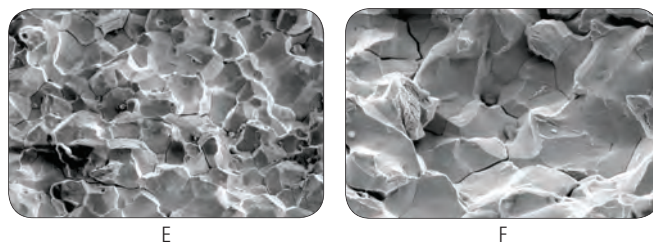

The detrimental effect of notching has been studied at great length in applications to structural assemblies. Notches and cuts which come to a sharp angle are undesirable due to the concentration of stress at the notch tip. There are many cases where notching is introduced to cause failure. Examples are scoring glass and sheetrock, and timber cutting.

Care must be taken when notching a prong for stone setting. A radius helps to distribute stress over a larger area and minimizes stress concentration. Avoid

manipulation of notched prong tips to prevent micro tears and rapid buildup of residual stress. Also avoid compressing notched prong tips too tightly against stones as this will increase the residual stress at the notched area of the prong by acting as a wedge.

Consideration should also be given to alloy selection to reduce chances of failure due to SCC. Platinum and gold alloys of 18K or higher are much more resistant to SCC than 14K and lower karat gold alloys. In a similar fashion, 14K palladium white gold alloys are extremely resistant to SCC where as 14K nickel white alloys are susceptible to SCC.

Now that we know that the failure of a piece of jewelry due to SCC can only occur with certain alloys that have been exposed to a corrosive environment and only if residual stress exists, we can address the SCC phenomena by controlling many of the variables that cause SCC. Educating the end user about exposure of jewelry to corrosive environments is important but impossible to monitor. As a jeweler, you can minimize the risk of failure by SCC with proper alloy selection and stone setting techniques to reduce residual stress.

We hope that the above discussion has removed the mystique from this type of "mysterious" failure and provided you with the tools and knowledge to recognize and prevent prong failures incorrectly attributed to "bad metal" or "bad casting."

— Stuller's Metals Technology Team

Precautionary Measures to Avoid Stress Corrosion

- 1) If stress has been applied or loaded into a product, coat piece with boric/alcohol, soak at 650° F for 45 minutes, allow to air cool. This will relieve the stress without adverse effects such as loss of temper. Standard torch or oven annealing is sufficient to relieve stress.
- 2) How much stress? When reducing sheet or wire, avoid overworking. This can be identified by edge notching, which is undesirable. Reductions of 50% are standard between anneals, 37% reduction is considered full hard.
- 3) Avoid sharp notching. Use a slight radius if applicable, especially if stretching and compression must be applied to the notched areas.
- 4) Use 18K or platinum in key areas instead of low karat or nickel whites. These metals have a much higher tolerance to corrosives.
- 5) Avoid too much heat or excessive time exposure to heat. Allow pieces to cool slowly. Repetitious heating to red zones is not recommended unless sufficient cold work is applied between heats. Avoid dull cutting tools and use a lubricant to avoid generating excess heat.
- 6) Avoid contact with corrosive liquids, solids or gasses. The seacoast and semi-tropical areas produce chlorides which combine with the salts produced through perspiration to form a corrosive element that discolors the skin. Smog fumes filled with particles of silver dioxide and phosphate also gradually attack jewelry.
- 7) Prong work is of particular concern. Take care to not stretch prongs out of parallel. This increases the angle required to move the prong tip over the stone thus increasing stress and compression. It's the jeweler's responsibility to control and decrease stress. Make it a point to work "stress free."

Differences Between Traditional Sterling Silver and Sterlium Plus™

INVESTMENT CASTING

	Traditional Sterling	Sterlium Plus™
Casting Temperature	1778° F (970° C)	1850° F (1010° C) (higher cast temperature)
Flask Temperature	Adjusts to size and weight of castings	Adjusts to size and weight of castings
Casting Flux	Boric Acid - skim off before casting	Boric Acid - skim off before casting
Quench Time, (4"×8" flask)	15 to 20 minutes	20 to 25 minutes
Investment Removal	Any proprietary investment remover	Any proprietary investment remover
Pickling After Casting	Required to remove black oxidation	Usually not required, castings are white
Reuse	50% scrap and 50% fresh metal	50% scrap and 50% fresh metal
NOTE:	Remove all investment residues before reuse	Remove all investment residues before reuse

FABRICATION AND SOLDERING

	Traditional Sterling	Sterlium Plus™
Ingot Molds	Use two piece vertical molds	Use two piece vertical molds
<i>Note for both:</i> Avoid using horizontal slot type molds for ingot casting as a shrink down the center of the ingot will cause an area of porosity down the center of the rolled or drawn stock. Preheat the mold and use a light oil or spray graphite to keep the metal from sticking.		
Pouring Temperature	1800° F (982° C)	1886° F (1030° C)
Flux	Borax or Boric Acid - skim before annealing	Boric Acid - skim before annealing
Quenching	Quench quickly after pouring	Quench quickly after pouring
Rolling	Take 50% to 70% reduction before annealing	Take 50% reduction before annealing
Annealing	1250° F (676° C), 20 to 30 minutes (use a fire coat for open annealing)	1150° F (676° C), 20 to 30 minutes (use and fire coat for open annealing)
Pickling	Ingots will need to be pickled to remove oxide	Ingots will need to be pickled to remove oxide
Cleaning	Scrub ingots clean before use	Scrub ingots clean before use
Soldering	Regular silver solder should be used	Regular silver solders should be used
Fire Coat	A fire coat should be applied	A fire coat should be applied
Solder Flux	Use plenty of flux for soldering	Use plenty of flux for soldering (Will not oxidize as heavily, but needs flux to remove the invisible silicon-dioxide coating)

Disclaimer: Sterlium Plus is not suitable for Mokume processes and is not appropriate for reticulating sterling silver.

Metal Drawing and Forming

DURSTON ROLLING MILLS

Durston is the foremost manufacturer of rolling mills throughout the world. They are recognized for their reliability, robust construction, high quality, and fine finish.

These are exactly the same as their standard models but without the extension rollers on the end. Excellent choice for users who will not use the extension rollers. Own the only top quality rolling mill at a great price.

An affordable line of mills with a great degree of versatility for producing strip and wire. The roll gap is calibrated to allow the greatest reduction per pass with ease of turning. One-piece cast iron housing for great strength with maintenance-free bearings. Large easy-to-read calibrated discs.

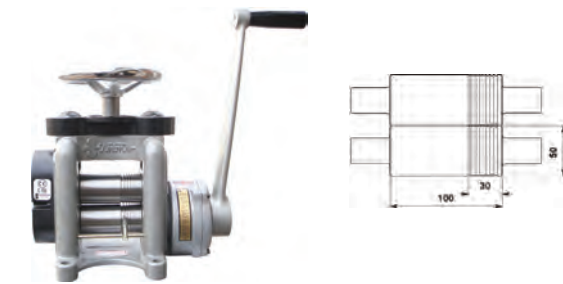

Model C100 R

Order #	W x D x H	Shipping Weight	1+
28-1996	14" x 8" x 12½"	70 lbs	\$899.00

- Roll Size: 100 mm x 50 mm
- Sheet Capacity: 6 mm
- Width of Flat: 70 mm
- Wire Capacity: 7-1 mm
- Number of Wire Grooves: 9
- Gear Ratio: 4:1



Model C130 R

Order #	W x D x H	Shipping Weight	1+
28-1997	14" x 9" x 14"	101 lbs	\$1,035.00

- Roll Size: 130 mm x 60 mm
- Sheet Capacity: 7 mm
- Width of Flat: 80 mm
- Wire Capacity: 8-1 mm
- Number of Wire Grooves: 11
- Gear Ratio: 5:1

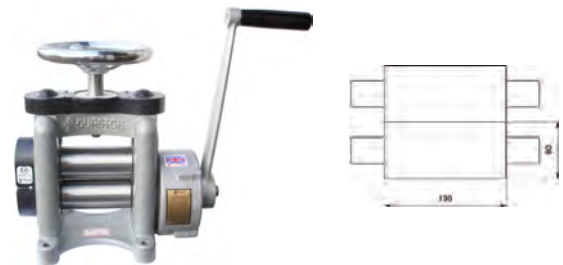

Model F130 R

Order #	W x D x H	Shipping Weight	1+
28-1998	16" x 9" x 14"	101 lbs	\$1,017.00

- Roll Size: 130 mm x 60 mm
- Sheet Capacity: 7 mm
- Width of Flat: 130 mm
- Gear Ratio: 5:1



Model MINI C80

Order #	W x D x H	Shipping Weight	1+
28-2002	10" x 4½" x 10"	38 lbs	\$725.00

- Roll Size: 80 mm x 45 mm
- Sheet Capacity: 6 mm
- Width of Flat: 60 mm
- Wire Capacity: 6.5-1 mm
- Number of Wire Grooves: 4
- Gear Ratio: Direct
- Extension Rollers: Drive



Model MINI F80

Order #	W x D x H	Shipping Weight	1+
28-2003	10" x 4½" x 10"	38 lbs	\$728.00

- Roll Size: 80 mm x 45 mm
- Sheet Capacity: 6 mm
- Width of Flat: 80 mm
- Gear Ratio: Direct
- Extension Rollers: Drive

Model C100 RE

Order #	W x D x H	Shipping Weight	1+
28-2004	14" x 8" x 12½"	76 lbs	\$1,095.00

- Roll Size: 100 mm x 50 mm
- Sheet Capacity: 6 mm
- Width of Flat: 70 mm
- Wire Capacity: 7-1 mm
- Number of Wire Grooves: 9
- Gear Ratio: 4:1

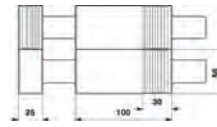

Model C130 RE

Order #	W x D x H	Shipping Weight	1+
28-2005	16" x 8½" x 14"	105 lbs	\$1,336.00

- Roll Size: 130 mm x 60 mm
- Sheet Capacity: 7 mm
- Width of Flat: 80 mm
- Wire Capacity: 8-1 mm
- Number of Wire Grooves: 11
- Gear Ratio: 5:1



Model DRM RF 100 RE

Order #	W x D x H	Shipping Weight	1+
28-1992	14" x 8" x 12½"	70 lbs	\$1,312.00

- Roll Size: 100 mm x 50 mm
- Sheet Capacity: 5.5 mm
- Width of Flat: 45 mm
- Wire Capacity: 6-2 mm
- Number of Wire Grooves: 9
- Gear Ratio: 4:1

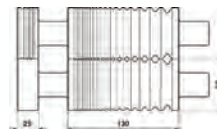

Model DRM 130 RE

Order #	W x D x H	Shipping Weight	1+
28-1993	16" x 8½" x 14"	101 lbs	\$1,510.00

- Roll Size: 130 mm x 50 mm
- Sheet Capacity: 6 mm
- Width of Flat: 75 mm
- Wire Capacity: 6-2 mm
- Number of Wire Grooves: 9
- Gear Ratio: 5:1

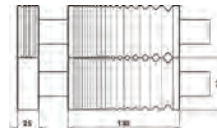

CABINET STAND

Suited to the Durston D2 130 and D4 158 manual rolling mills. The stand is drilled and tapped with appropriate holes. Bolts are supplied for the mill required. The stand has excellent storage space with two shelves and a locking flush door with two keys. The construction is very sturdy and made of 0.25" plate steel. Finish is attractive metallic silver coated paint inside and out. The stand should be secured to floor using appropriate bolts.

PEDESTAL STAND

Suited to the Durston Mini Mill, DRM 130, and DRM150 manual mills. The stand is drilled and tapped with appropriate holes. Bolts are supplied for the mill required. The stand should be secured to floor using appropriate bolts.

Item	Order #	Description	W x D x H	1+
D	28-2007	Cabinet Stand	13 ¹³ / ₁₆ " x 13 ¹³ / ₁₆ " x 35 ⁷ / ₁₆ "	397.00
E	28-2008	Pedestal	11 ¹³ / ₁₆ " x 13 ¹³ / ₁₆ " x 33"	277.00



Metal Drawing and Forming

Model 130 DSP



DURSTON ROLLING MILLS

Durston bench-top power mills are the most sought after power mills in the world. These mills have cast iron bases, cast iron gear boxes with powerful motors, and, of course, the standard one-piece cast iron mill frame incorporating our high quality steel rollers, which run on heavy duty roller bearings.

Model 130 DSP

Order #	W x D x H	Shipping Weight	1+
28-1991	16½" x 8½" x 21¼"	400 lbs	\$4,634.00

- Roll Size: 130 mm x 65 mm
- Sheet Capacity: 6 mm
- Width of Flat: 130 mm
- Wire Capacity: 10-1 mm
- Number of Wire Grooves: 19

Model Double D2 130

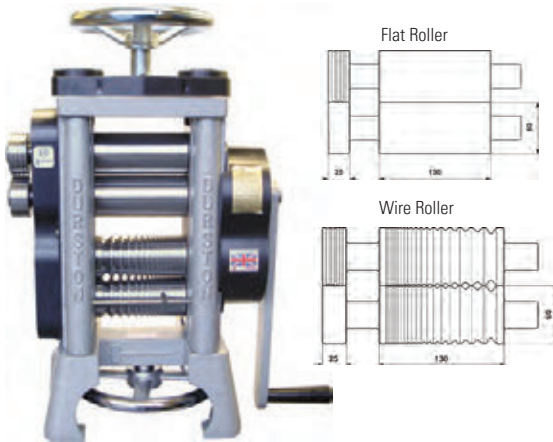

Model DOUBLE D2 130

Order #	W x D x H	Shipping Weight	1+
28-2006	16½" x 8½" x 22¼"	155 lbs	\$2,250.00

- Roll Size: 130 mm x 60 mm
- Sheet Capacity: 7 mm
- Width of Flat: 130 mm
- Gear Ratio: 7:1



Model FSM 160

FSM 160 FLOOR STANDING MILL

Available in three speed configurations. Fixed speed, variable speed, and computer control panel that offers more information such as roll speed, pressure and oil indicator, and work light.

- Forward and reverse
 - Automatic lubrication to roll bearings
 - 130 mill flat, 19 square grooves
 - Powerful 4kw motor
 - Heavy duty cast iron gear box
 - Digital roll gap meter (optional)
 - Work lights (optional) Requires special ordering and 8 week delivery.
- Shipping fees included for model FSM 160 Floor Standing Mill.

Model FSM 160

Order #	W x D x H	Shipping Weight	1+
28-1994	49" x 19½" x 58¼"	1,345 lbs	\$19,950.00

- Roll Size: 160 mm x 86 mm
- Sheet Capacity: 25 mm
- Wire Capacity: 1-9 mm
- Number of Wire Grooves: 19



TUNGSTEN-CARBIDE DRAWPLATES

Tungsten-carbide inserts are permanently fixed in marked steel plate. Angle of reduction is made to exact specifications for the smoothest possible pull.

Item	Order #	Hole:	Number of Holes	12+	6+	1+
		Largest–Smallest				
A	28-0422	1mm – 0.26mm	24	\$46.71	\$49.46	\$54.95
B	28-0423	2.8mm - 0.26mm	39	\$54.40	\$57.60	\$64.00
C	28-0425	6mm – 2.3mm	24	\$72.89	\$77.18	\$85.75



TOOL-STEEL DRAWPLATES

Made of thick, high-grade tool steel with accurately machined and smoothly beveled holes. This allows wire to be drawn easily from larger holes to successively smaller holes to obtain the size and shape wire needed. Works on brass, copper, gold, silver, platinum, and soft steel wire. Plate is stamped with style identifying letter and hole sizes. Beeswax can be used as a lubricant.

Item	Order #	Hole:	Number of Holes	12+	6+	1+
		Largest–Smallest				
D	28-0440	2.94mm - 0.56mm	31	\$66.26	\$70.16	\$77.95
E	28-0460	4.76mm - 2.38mm	30	\$141.06	\$149.35	\$165.95
F	28-0472	3.97mm - Filigree	20	\$80.75	\$85.50	\$95.00

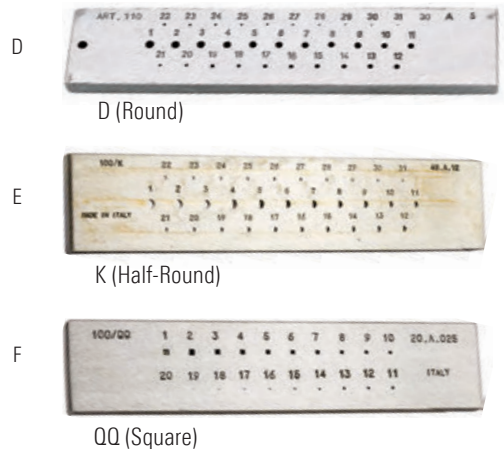

LOWELL PATTERN HAND VISE

Combination hand vise ideal for gripping small objects or for use as a small draw tong. Made of forged steel. Long, firm grip handle and serrated jaws. Made in Poland.

Order #	Length	Jaw Width	12+	6+	1+
58-1412	5½"	½"	\$25.08	\$26.55	\$29.50



DRAW TONGS

Made of forged steel. Used to pull wire through drawplates. A strong grip is attainable due to the serrated jaws.

Item	Order #	Description	Length	Origin	1+
G	57-0560	Draw Tong	8"	India	\$20.00
H	57-0580	Draw Tong	10"	India	\$26.00



183 lbs

DURSTON BENCH

This draw bench has a working length of 38", a 4:1 gear ratio, and can handle a maximum thickness of 10mm wire. German draw tongs included.

Order #	Description	W x L x H	1+
28-2009	Draw Bench	22" x 55" x 39"	\$1,020.00

Metal Drawing and Forming



PRECIOUS METAL HAND STAMPS

Made of hand-cut steel to stamp impressions on metal surfaces.

Bent: 1/32" (0.8mm) 1/45" (0.6mm)

Straight: 1/32" (0.8mm) 1/45" (0.6mm)

Order #	Description	Metal	Type	12+	6+	1+
55-3335	Palladium	1/32"	Bent	\$20.15	\$21.33	\$23.70
55-3336	Palladium	1/32"	Straight	\$20.15	\$21.33	\$23.70
55-3230	Platinum	1/45"	Bent	\$22.14	\$23.45	\$26.05
55-2722	18kt	1/32"	Bent	\$16.36	\$17.33	\$19.25
55-2723	18kt	1/45"	Bent	\$16.36	\$17.33	\$19.25
55-2622	14kt	1/32"	Bent	\$16.36	\$17.33	\$19.25
55-2623	14kt	1/45"	Bent	\$16.36	\$17.33	\$19.25
55-2922	14kt	1/32"	Straight	\$16.36	\$17.33	\$19.25
55-2923	14kt	1/45"	Straight	\$16.36	\$17.33	\$19.25
55-2522	10kt	1/32"	Bent	\$16.36	\$17.33	\$19.25
55-2523	10kt	1/45"	Bent	\$16.36	\$17.33	\$19.25
55-3022	Sterling	1/32"	Bent	\$22.53	\$23.85	\$26.50
55-3023	Sterling	1/45"	Bent	\$22.53	\$23.85	\$26.50
55-3122	Sterling	1/32"	Straight	\$22.95	\$24.30	\$27.00
55-3123	Sterling	1/45"	Straight	\$22.95	\$24.30	\$27.00
55-3222	Copyright - ©	1/32"	Bent	\$21.12	\$22.37	\$24.85
55-3223	Copyright - ©	1/45"	Bent	\$17.00	\$18.00	\$20.00
55-3322	Copyright - ©	1/32"	Straight	\$21.55	\$22.82	\$25.35



JEWELRY MARKING MACHINE

Perfect impressions and identification markings on all rings, charms, disks, or any flat pieces. Kit includes: spring action lever machine with automatic return to upright positions, six punches (one each bent and straight 10kt, 14kt, 18kt), and three nylon anvils. Wooden base has storage for spare parts.

Order #	Description	12+	6+	1+
55-2553	Jewelry Marking Machine Kit	\$363.42	\$384.80	\$427.55
55-2554	Nylon Anvil	\$3.57	\$3.78	\$4.20
55-2555	10kt Straight Punch	\$36.30	\$38.43	\$42.70
55-2556	14kt Straight Punch	\$36.30	\$38.43	\$42.70
55-2557	18kt Straight Punch	\$36.30	\$38.43	\$42.70
55-2558	10kt Bent Punch	\$42.16	\$44.64	\$49.60
55-2562	Sterling Bent Punch	\$53.38	\$56.52	\$62.80
55-2559	14kt Bent Punch	\$42.16	\$44.64	\$49.60
55-2560	18kt Bent Punch	\$42.16	\$44.64	\$49.60
55-2561	Sterling Straight Punch	\$82.41	\$87.26	\$96.95



STAINLESS STEEL JEWELRY MARKING PLIERS

Used to stamp precious metals with karat stamps using little pressure. Use on curved or flat surfaces. No set-up or hammering required. Stamp inside rings as small as size four. Made of durable stainless steel. Adjustable screw-locks stamp in place. Punches sold individually.

Order #	Description	Length	12+	6+	1+
46-2400	Marking Pliers	5 1/2"	\$65.45	\$69.30	\$77.00
46-2410	Replacement Nylon Anvil		\$3.40	\$3.60	\$4.00
55-2401	10kt Punch		\$21.25	\$22.50	\$25.00
55-2402	14kt Punch		\$21.25	\$22.50	\$25.00
55-2403	18kt Punch		\$21.25	\$22.50	\$25.00
55-2407	Sterling Silver Punch		\$21.25	\$22.50	\$25.00

27-PIECE LETTER STAMP SET

Hardened steel stamps of the complete alphabet and a period come in a hardwood storage box. Made in the USA.



Order #	Impression	Length	12+	6+	1+
55-2551	1/16 inch (1.6mm)	2 3/8"	\$50.15	\$53.10	\$59.00
55-2552	1/8 inch (0.8mm)	2 3/8"	\$51.51	\$54.54	\$60.60



STEEL STAMPS

All stamp diameters 1/4".

Stamp lengths 2 3/8".

A Character size: 1/16". Figures: 0-8 (Use 6 as 9)

B Character size: 3/32". Figures: 0-8 (Use 6 as 9)

C Character size: 1/16". Figures: A-Z and period mark

D Character size: 3/32". Figures: A-Z and period mark



Item	Order #	Description	Assortment Qty	Size	12+	6+	1+
A	55-2540	Numbers 0-8	9	1/16"	\$20.61	\$21.83	\$24.25
B	55-2541	Numbers 0-8	9	3/32"	\$20.61	\$21.83	\$24.25
C	55-2542	Letters A-Z	27	1/16"	\$46.84	\$49.59	\$55.10
D	55-2543	Letters A-Z	27	3/32"	\$46.84	\$49.59	\$55.10

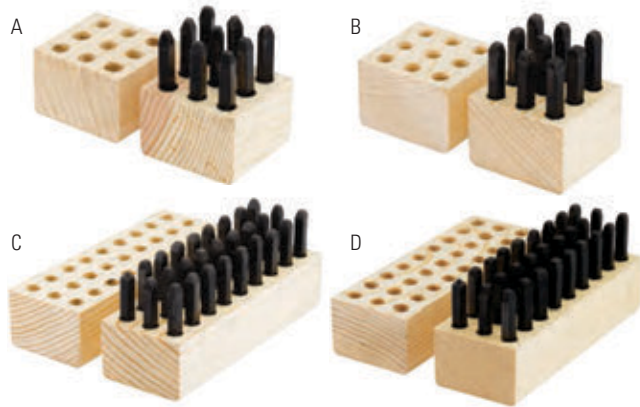

BRASS STAMPING ANVIL

Brass anvil with graduated sizes within specific shapes to prevent flat spotting while stamping. One side for women and one side for men's rings.

Order #	Description	W x L x H	12+	6+	1+
55-3340	Brass Stamping Anvil	1 1/4" x 3" x 3/4"	\$19.25	\$20.39	\$22.65



METRIC TAP AND DIE SET

Precision metric tap and die set consists of eight dies covering the range from 1mm to 3mm. Also included is a die holder, adjustable tap holder, eight sets of three right taps (total 24), and a fitted hardwood case. Made in Germany.

Order #	Description	1+
25-2002	Metric Tap & Die Set	\$438.00



GRS® METAL FORMER

Easily shape "C" style bracelets with the GRS® Bracelet Former. Form flat strips of metal to a perfect "C" shape after you have engraved your design. The die cup contains a soft alloy material that supports pressure from the die, but does not distort your engraving work. The die cup material can be reformed by heating when necessary.

Order #	Description	12+	6+	1+
25-0574	Metal Former	\$216.75	\$229.50	\$255.00

Metal Drawing and Forming



DURSTON 23 HOLE DAPPING BLOCK

This dapping block has 23 half spheres in sizes 3mm, 4mm, 5mm, 6mm, 7mm, 8mm, 9mm, 10mm, 11mm, 12mm, 13mm, 14mm, 15mm, 16mm, 17mm, 19mm, 21mm, 23mm, 25mm, 27mm, 30mm, 34mm, and 38mm

Order #	Description	W x L x H	12+	6+	1+
25-0581	Dapping Block	3¼" x 5¾" x 1¼"	\$76.50	\$81.00	\$90.00



DURSTON 14 DEPRESSION FORMING BLOCK

This forming block has 14 half spheres in sizes 5mm, 6mm, 7mm, 8mm, 9mm, 10mm, 11mm, 13mm, 15mm, 16mm, 17mm, 22mm, 23mm, and 24mm. There are also 8 half cut outs in sizes 5mm, 6mm, 8mm, 9mm, 15mm, 16mm, 17.5mm, 22mm, and 26mm

Order #	Description	W x L x H	12+	6+	1+
25-0580	Forming Block	2½" x 3¾" x 1"	\$96.90	\$102.60	\$114.00

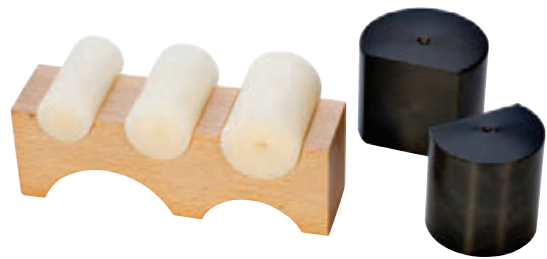

BENDING BLOCK WITH NYLON FORMING ROLLER

This high-quality hardwood forming block is great for bending and forming without marring. Lighter weight and less expensive than the steel version, the large grooves consist of three half-round (1¼", 1½", 1¾") and two larger third-round (2½", 3¼") channels.

Order #	Description	W x L x H	12+	6+	1+
25-0444	Bending Block	1⅞" x 7 x 2⅝"	\$37.40	\$39.60	\$44.00



LARGER HARDWOOD SHAPING BLOCK

Exceptional hardwood will hold up to heavy work without the risk of marring your metal surface. It features two round 5" depressions, one is 23mm deep and the other is 28mm deep. Four U channel grooves run the length of two sides of the block.

Order #	Description	W x L x H	12+	6+	1+
25-1352	Shaping Block	6" x 6" x 2½"	\$26.35	\$27.90	\$31.00



WOOD DAPPING BLOCK AND PUNCHES

Handmade, hardwood block with six depressions, one on each side. Block measures 2¼" square. Includes two punches. Use block in combination with punches to shape lockets, cases, and remove dents.

Order #	Description	12+	6+	1+
25-1350	Dapping Block with Punches	\$11.05	\$11.70	\$13.00



NON-MARRING SHAPING BLOCK

These domed hardwood punches and wood block are perfect for non-marring dapping work. The wood block also has a 3" x 3" flat steel surface. Each of the seven depressions are 1/2" deep and have the following diameters: 2 1/4", 1 3/4", 1 1/2", 1 1/4", 1", 7/8", and 3/4". The punches are 3/4".

Order #	Description	12+	6+	1+
25-1354	Shaping Block	\$33.58	\$35.55	\$39.50



GRADUATED DAPPING BLOCK AND PUNCH SET

This large, double-sided hardwood block features 10 machined half-spheres, clearly marked with the disc size they accept (65mm-16mm) and matching punches. Concave dimensions largest to smallest: 2 1/2" to 5/8" (65mm-16mm).

Order #	Description	W x L x H	12+	6+	1+
25-1353	Shaping Block	4" x 7" x 3"	\$72.25	\$76.50	\$85.00

DAPPING DIES AND BLOCKS

Hardened steel design blocks are used to form hemispheric depressions on different metals. Grooved edges are used for shaping and bending rings, settings, bezels, and other items.

A and B. **17 Round** depressions measuring up to 1 3/4" in size on a hardened steel square die.

C. **27 Round** depressions measuring 1.5mm - 25mm. Used in conjunction with dapping punches to produce hemispheres.

D. **17 Round** depressions - 2mm, 3mm, 3.5mm, 4mm, 4.5mm, 5mm, 5.5mm, 6mm, 7.5mm, 8mm, 8.5mm, 9mm, 11mm, 11.5mm, 13mm, 17mm, 20mm; 5 Oval depressions - 12.5mm x 19.5mm, 14.5mm x 19mm, 15mm x 22mm, 20mm x 27mm, 18mm x 26.5mm

3 V-shaped grooves - (w x d) - 4mm x 1.5mm, 5mm x 2mm, 6mm x 3mm
20 Half-Round grooves - 2mm x 1.5mm, 3mm x 1.75mm, 3mm x 1.25mm, 3mm x 1mm, 3mm x 2mm, 3mm x 1.5mm, 5mm x 2mm, 5mm x 2.25mm, 6mm x 2.5mm, 6mm x 3mm, 7mm x 3mm, 8mm x 4mm, 9mm x 3.5mm, 10mm x 4mm, 12mm x 4mm, 14mm x 5mm, 17mm x 6mm, 20mm x 7mm, 21mm x 7mm, 24mm x 8mm

E. **5 Half-Round** grooves - 71mm x 13mm, 69mm x 20mm, 45mm x 21mm, 55mm x 26mm, 35mm x 16mm

Item	Order #	Description	W x L x H	12+	6+	1+
A	25-0570	17 Depressions	2 1/2"	\$40.76	\$43.16	\$47.95
B	25-0571	17 Depressions	2"	\$32.26	\$34.16	\$37.95
C	25-0550	27 Depressions	2 1/2" x 5 1/2" x 3/4"	\$84.32	\$89.28	\$99.20
D	25-0440	22 Depressions	35mm x 220mm x 35mm	\$37.44	\$39.65	\$44.05
E	25-0445	5 Grooves	60mm x 160mm x 60mm	\$66.30	\$70.20	\$78.00

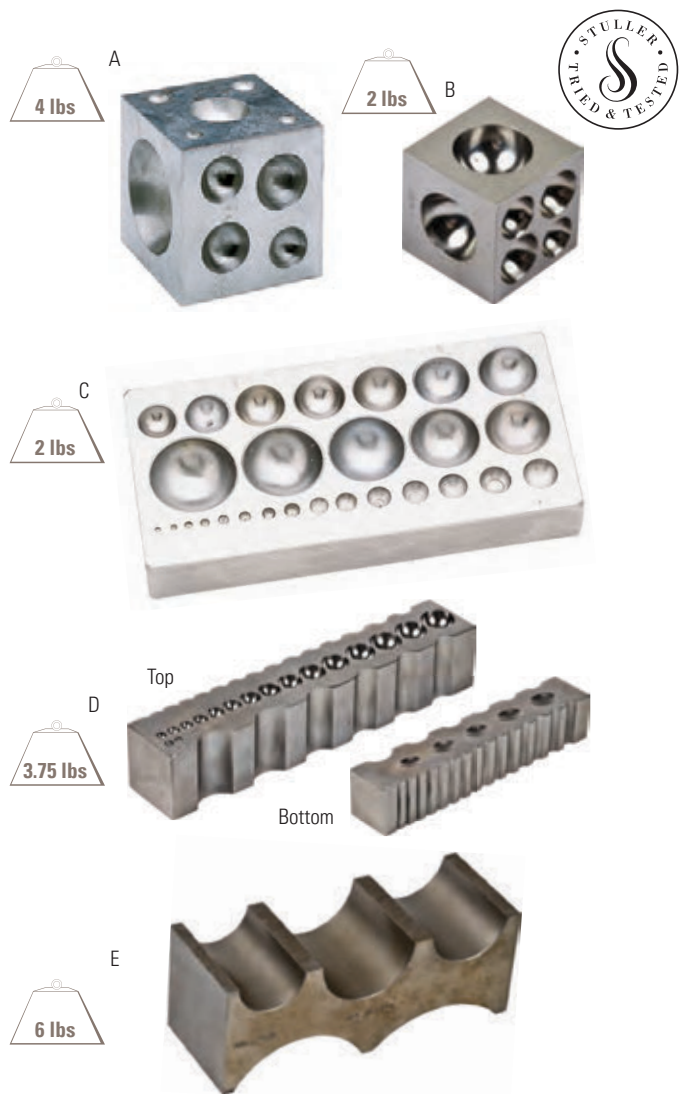

Your most valuable tools are your hands.

LET US LEND YOU AN EXTRA ONE.



BenchJeweler.com aims to give you a place where you can hone your craft and share your voice. We understand that the needs of a bench jeweler are different from those on the sales floor. With this in mind, we've been working hard to redesign the site in a way that highlights your favorite parts and makes them easy to find and access.

JOIN OUR *community.* SHARE YOUR *voice.* HONE YOUR *craft.*



MEMBERS-ONLY DEALS

Check out members-only deals on refurbished items.

HOW-TO VIDEOS

Look through hundreds of how-to videos to help you get the job done right.

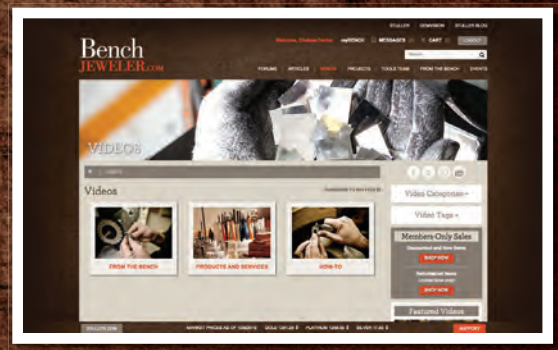

FORUMS

Ask questions and get answers from your peers and experts on the Stuller Tools Tech Team.

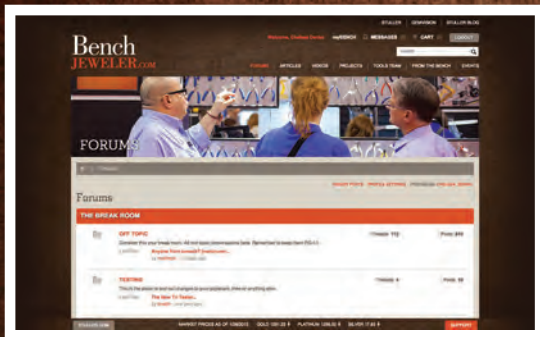

Rediscover your own global workbench, just a swivel and click away at the new and improved BenchJeweler.com.

Bench **JEWELER**.COM

powered by  STULLER

Metal Drawing and Forming

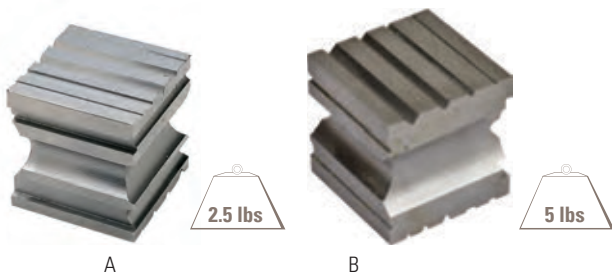

FORMING BLOCKS

Six grooved sides offer a wide variety of unique shapes in many different sizes. Half-round, triangle, square, and rectangular shapes provide great forming versatility. Machined from high-grade tool steel. Hardened to 50 RC.

Item	Order #	Description	Size	12+	6+	1+
A	25-0565	Small Forming Block	2 1/4"	\$76.80	\$81.32	\$90.35
B	25-0566	Large Forming Block	2 3/4"	\$73.44	\$77.76	\$86.40



CUPOLA SETS

High quality dapping sets for the professional jeweler who demands the best. All pieces are hardened, ground, and highly polished for perfect results. All pieces fit into a unique plastic carrying tray.

Item	Order #	Description	Punches	Size	12+	6+	1+
C	25-1237	Large Cupola Set	6	50mm - 80mm	\$262.57	\$278.01	\$308.90
D	25-1234	Small Cupola Set	3	50mm - 57mm	\$63.75	\$67.50	\$75.00
E	25-1235	Medium Cupola Set	3	57mm - 64mm	\$90.95	\$96.30	\$107.00
F	25-1236	Large Cupola Set	3	78mm - 85mm	\$119.00	\$126.00	\$140.00



DURSTON DAPPING SET

High quality dapping set for the professional jeweler who demands the best. All pieces are hardened, ground, and highly polished for perfect results. Comes with 24 punches ranging from 3mm to 50mm (3-15, 17, 19, 21, 23, 25, 28, 32, 36, 40, 45, and 50mm). Matching 65mm square dapping block with 26 full half-spheres all fit into a neatly molded base with carrying handle.

Order #	Description	12+	6+	1+
25-1233	Large Set (24 punches)	\$266.05	\$281.70	\$313.00

DAPPING PUNCHES SET

These perfectly matched punches are 1mm smaller than the cavity diameters in our dapping blocks. This was done in order to allow for the thickness of the metal being formed, so the punch diameter will match the inside diameter of the dome being formed. Comes with wooden base.

Set of 5: 27.6mm, 30.8mm, 37.1mm, 43.5mm, 49.8mm



Order #	Description	12+	6+	1+
25-1229	Set of 5 Punches	\$105.32	\$111.51	\$123.90

DAPPING PUNCHES SET

Precision-made, highly polished dapping punches are made from tool steel and hardened to 50 RC on both hit and work ends. Unique tempering method leaves the shank of the punch at mill hardness of 32 RC–36 RC. This allows the handle to absorb the shock and prevent crystallization of the metal.

Set of 30: 2.8mm, 3.2mm, 3.6mm, 4.0mm, 5.6mm, 6.4mm, 7.1mm, 7.9mm, 9.5mm, 10.3mm, 11.1mm, 11.9mm, 12.7mm, 14.3mm, 15.1mm, 15.9mm, 17.5mm, 18.3mm, 19.1mm, 19.8mm, 20.6mm, 22.2mm, 23.0mm, 24.6mm, 25.4mm, 28.6mm, 31.8mm, 38.1mm, 44.5mm, and 50.8mm



Order #	Description	12+	6+	1+
25-1228	Set of 30 Punches	\$186.49	\$197.46	\$219.40



DAPPING CUTTERS SET

Precision cutting punches provide you with fabrication and design versatility. Lightly hit the punch to create a surface texture in a variety of designs. The punch can be used to cut soft metals up to 28 gauge. The sharp milled edges will produce a sharp and clean cut.

Set of 22: 2.8mm, 3.2mm, 3.6mm, 4.0mm, 5.6mm, 6.4mm, 7.1mm, 7.9mm, 9.5mm, 10.3mm, 11.1mm, 11.9mm, 12.7mm, 14.3mm, 15.1mm, 15.9mm, 17.5mm, 18.3mm, 19.1mm, 19.8mm, 20.6mm, and 22.2mm



Order #	Description	12+	6+	1+
25-1230	Set of 22 Cutters	\$116.03	\$122.85	\$136.50



DELUXE DAPPING SET

This dapping set includes a 2" dapping block with 18 depressions and 24 dapping punches. Punches range in size from 9/64" to 1" and are composed of case-hardened steel for years of excellent performance. Also included is a 2" dapping block and a wooden stand to keep it all organized.

Features:

- Wood stand
- 2" dapping block with 18 depressions
- 24 dapping punches
- Case-hardened
- Punch sizes: 1", 15/16", 7/8", 13/16", 25/32", 3/4", 23/32", 11/16", 5/8", 19/32", 9/16", 1/2", 15/32", 17/16", 13/32", 3/8", 5/16", 9/32", 1/4", 7/32", 5/32", 7/32", 5/32", 7/64", 1/8", 9/64"
- Depression sizes: 35, 31, 28, 25, 21, 20, 19, 17, 15, 14, 12, 11, 9, 8, 6, 5, and two 3mm



Order #	Description	W x L x H	12+	6+	1+
25-0575	Dapping Set	4 1/2" x 8" x 5 1/2"	\$70.64	\$74.79	\$83.10

Metal Drawing and Forming



FLAT DAPPING SET WITH BLOCK

Set includes high-grade, hardened steel with 14 hemispherical depressions in two rows. Graded in 1/16" increments from 1/8" to 7/8" plus 1" and 1 1/2" matching punches. Block measures 5 1/8" x 2 1/2" x 3/4".

Order #	Description	12+	6+	1+
25-0573	Flat Dapping Set with Block	\$74.93	\$79.33	\$88.15

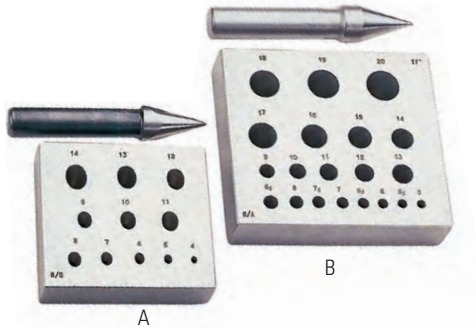

BEZEL BLOCKS & PUNCHES

Bezel blocks and punches used to form various shapes of conical bezels. Made from a hardened, tempered steel. Made in Italy.

Item	Order #	Description	12+	6+	1+
A	25-0600	Oval Bezel Block	\$165.75	\$175.50	\$195.00
B	25-0602	Round Bezel Block	\$106.25	\$112.50	\$125.00



PROFESSIONAL FORMING SET

The set includes a forming block and has six grooved sides. Half-round, triangle, square, and rectangular shapes. Machined high groove steel.

Order #	Description	12+	6+	1+
25-1341	26-Piece Professional Forming Set	\$317.39	\$336.06	\$373.40



DURSTON BENDING BLOCK SET

A highly polished hardened steel bending block for forging and bending. The block includes a total of 15 half rounds in sizes 1mm, 2mm, 3mm, 4mm, 5mm, 6mm, 7mm, 8mm, 9mm, 10, 12mm, and 16mm. Also uniquely includes 10 holes in the side in sizes 10mm, 9mm, 8mm, 7mm, 6mm, 5mm, 4mm, 3mm, 2mm, and 1mm.

Order #	Description	12+	6+	1+
25-1240	Bending Block Set	\$165.75	\$175.50	\$195.00



DURSTON DAPPING CUTTER/ TEXTURING SET

These dapping cutters are used to make creative designs. The sizes include 3mm, 4mm, 5mm, 6mm, 7mm, 8mm, 9mm, 10mm, 11mm, 12mm, 13mm, 14mm, 15mm, 17mm, 19mm, and 20mm.

Order #	Description	12+	6+	1+
25-1241	Dapping Cutter/ Texturing Set	\$111.56	\$118.13	\$131.25

Plating Units

These new plating units are made in Italy to our specifications. Built for small or medium-sized operations, they are affordable and easy enough for a beginner to operate. Use them during finishing, sampling, and repair.

Choose from the five-station unit, two-station unit, or the pen plater. Each is made of stainless steel with beakers. These units feature digital temperature control, a timer, and automatic shut off.

PEN PLATING UNIT

A. This pen plating unit is a safe contained complete pen plating system. It comes complete with 3 plating beakers, digital controller, sensor thermocouple, and anode.

TWO BEAKER RHODIUM PLATING UNIT

B. This 2 beaker plating unit is a self contained complete plating system. It comes complete with 2-600ml beakers, 1 heating element, digital controller, sensor thermocouple, digital timer, and anode. It features a stainless steel body and has a cover for the beakers when not in use.

FIVE BEAKER RHODIUM PLATING UNIT

C. This 5 beaker plating unit is a self contained complete plating system. It comes complete with 5-600ml beakers, 2 heating elements, digital controller, sensor thermocouple, digital timer, and anodes. It features a stainless steel body and has a cover for the beakers when not in use.



Item	Order #	Description	1+
A	45-4020	110V Pen Plating Unit	\$575.00
B	45-4020	600ml 2 Beaker Plating Unit, 1 Heater	\$650.00
C	45-4020	600ml 5 Beaker Plating Unit, 2 Heater	\$995.00

ACCESSORIES

Item	Order #	Description	12+	6+	1+
D	45-4021	Digital Controller	\$67.96	\$71.96	\$79.95
E	45-4023	Digital Timer	\$67.96	\$71.96	\$79.95
F	45-4019	Heating Element Complete	\$54.36	\$57.56	\$63.95
G	45-4019	Heating Element	\$15.26	\$16.16	\$17.95
H	45-0327	Titanium Anode	\$47.56	\$50.36	\$55.95
J	45-0327	Stainless Steel Anode	\$19.51	\$20.66	\$22.95
K	45-4057	White Felt Bullet Tips (Pack of 10)	\$3.24	\$3.65	\$4.05
L	45-4058	Fine-Point Fiber Tips (Pack of 3)	\$2.12	\$2.21	\$2.30
M	45-6409	100ml Glass Beaker	\$3.83	\$4.05	\$4.50
	45-6409	250ml Glass Beaker	\$3.83	\$4.05	\$4.50
	45-6409	400ml Glass Beaker	\$7.61	\$8.06	\$8.95



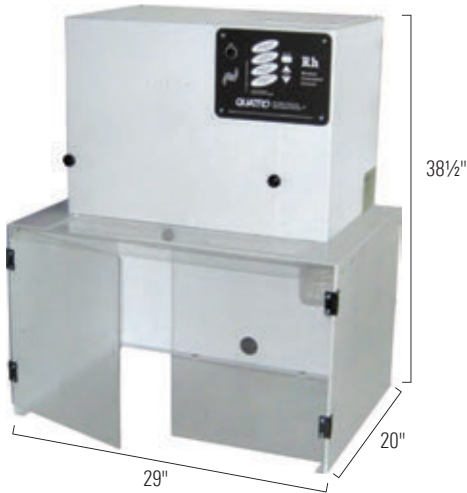

QUATRO RHODIUM HOOD

- Eliminates odor, vapors, and particulate matter migrating throughout the workplace
- Illuminated work area
- Small footprint friendly
- Can operate 24/7, allowing beakers to be left inside contained area
- Designed for quiet operation
- Can be ducted to the outside

Order #	Description	Assortment Qty	1+
47-6010	Fume Hood, 29 W" x 38½ H" x 20" D		\$1,249.00
REPLACEMENT FILTERS			
47-4090	BX Dust Filter	1	\$9.95
47-4216	HEPA Filter	1	\$137.70
47-4091	Odor Cartridge Filter	1	\$149.00
47-4093	Odor Filter F1 Rhodium Plating	1	\$175.00
47-6011	Filter Kit (all 4 filters)	4	\$316.15

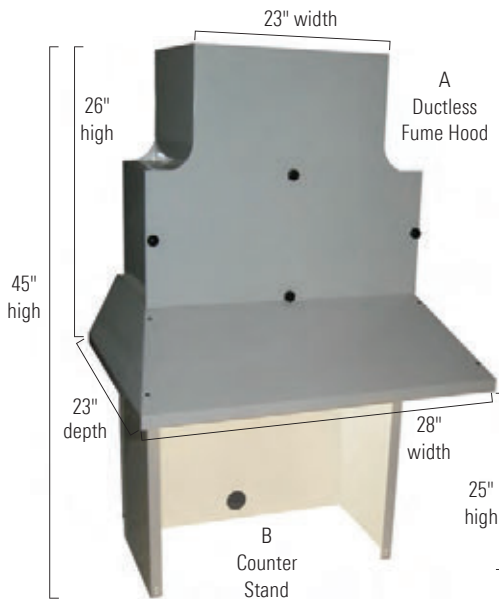

QUATRO DUCTLESS FUME HOOD DHF1000-B FOR RHODIUM

Capture odors via the Quatro Ductless Fume Hood and recirculate fresh air back into the room. Ideal for shops where it is difficult to access an outside wall, or you are not allowed to drill through an outside wall, or it is too costly to install duct work on the roof. Engineered to effectively work with the removal of plating fumes. Three-stage filtering process with maintenance-friendly design. Hood and stand sold separately.

- Overall Dimensions: 28" W x 23" D x 45" H
- Stand Dimensions: 22½" W x 25" H x 12" D
- Intake hood: 28" W x 26" H x 23" D
- Weight: Operating 50 lbs
- Voltage: 115V/60Hz, 1 amp



Item	Order #	Description	Assortment Qty	1+
A	47-3085	Ductless Fume Hood		\$1,164.00
B	47-4101	Counter Stand		\$275.80
REPLACEMENT FILTERS				
	47-4086	Dust Filters	8	\$78.45
	47-4087	#1 Odor Filter	1	\$159.00
	47-4092	Odor Filter Refill	2	\$122.00
	47-3088	Odor Neutralizing Container and Filter	1	\$200.55
	47-4069	Odor Filter Refill Only	5	\$179.30
	47-3087	HEPA Filter	1	\$128.00

Important! Remove wax elimination tray from the furnace after wax is melted out of flasks. Residue from burnt wax will greatly shorten life of heating elements and/or cause damage to the furnace.



RHODIUM PLATING KIT

Premium Rhodium Plating Kit is comprised of high quality components. This kit was created with the bench jeweler in mind. Durable items that will stand the test of time and can be depended on for years to come. Perfect for the bench jeweler looking to set up a rhodium plating section or for the jeweler looking to upgrade. Kit contains:

- 10 amp rectifier (45-4030)
- An immersion thermometer (45-6420)
- Platinized titanium anode (45-0321)
- A double burner (45-7120)
- Stainless steel anode (45-0326)
- Activator (45-2040)
- Three 600ml Pyrex® beakers (45-6400)
- ElectroCleaner (45-2020)
- Three lip covers (45-6401)



Order #	Description	1+
45-0150	Rhodium Plating Kit	\$580.00

RECTIFIER

Features industrial-grade, heavy-duty high-output transformers, oversized heat sinks, built-in cooling fan to prevent overheating, and an output current that is 99% filtered to ensure maximum and repeatable results. Insulated lead and clamp set. Adjustable voltage from 0-13v.

Order #	Description	Amp	1+
45-4044	Rectifier with Leads	25 amp	\$356.40



DIGITAL RECTIFIER

Features dual voltage for use anywhere in the world, control to the hundredth (.01) of a volt and amp., 99% filtration, self-restoring internal short protection, less than 1% ripple in voltage output that provides a superior plated surface, and small footprint takes up less space on the bench. Comes with a set of lead wires with alligator clips.

Order #	Description	Amp	1+
45-4027	Digital Rectifier	10 amp	\$389.95
45-4028	Digital Rectifier	25 amp	\$398.95



PLATING RECTIFIER

Precision built in the USA, continuous-duty, solid-state electronic units with a range of power to handle all plating needs. Works by means of the powerstat control to produce desired voltage. All units have pilot lights and both DC ammeter and voltmeter for measuring current under load. All units come with a set of lead wires with alligator clamps and terminal lugs. Specification for 10A:

- 0 to 10 amps output, continuous duty - 0 to 10 volts DC output
- Runs plating baths up to 1 gallon (3.81) except for rhodium, which is 2 quarts (1.91)
- Steel cabinet measures 13" W x 8" H x 8½" D (330mm x 203mm x 216mm)

Order #	Description	1+
45-4030	10A Plating Rectifier	\$389.95
45-4037	10A Terminal Plating Lead	\$12.10

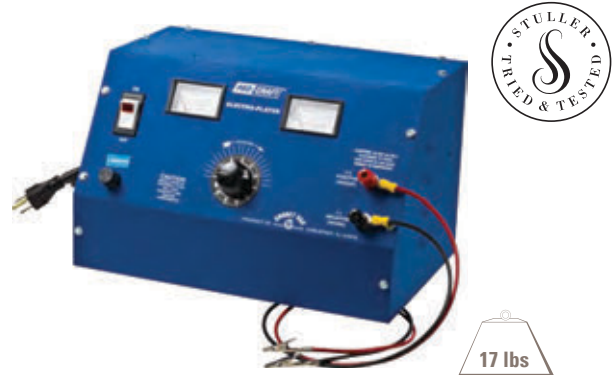

MIXER AND TEMPERATURE CONTROLLER

Keeps the magnetic mixer and temperature controlled heat-plating solutions evenly throughout by constantly stirring the solution. This set solves the problem of inconsistent plating due to thermo climate. The magnetic mixer and temperature controller are sold as a kit, but can be used separately with different applications. Features dual voltage for use anywhere in the world, speed control for agitation, a small footprint takes up less space on your work bench, a sensor and heater in solution that provide far superior temperature control, Fahrenheit or Celsius readout, and a faceplate of thermal controller that changes from blue to green when the desired temperature is reached. Beaker sold separately.

Order #	Description	1+
28-2042	Mixer with Temperature Controller	\$515.00



HOT PLATE

Three-ring tubular burners and infinite control switch. Unit has chrome top. 120V AC with three-prong grounded cord. Shipping weight 6 lbs.
 - Single burner measures 8½" x 8½" x 3¼" - Dual burner measures 17" x 8½" x 3¼"

Item	Order #	Description	Amps	Watts	1+
A	45-7119	Single Burner	6 amps	700 watts	\$56.05
B	45-7120	Double Burner	12 amps	1400 watts	\$95.35





GLASS BEAKER

- Low-expansion borosilicate 3.3 glass
- Designed to be heat-resistant and non-conductive
- Heavy and uniform wall thickness
- Easy pour spouts and white printed graduation and marking area

Item	Order #	Container Volume	12+	6+	1+
A	45-6412	30 ml	\$2.80	\$3.20	\$4.00
B	45-6412	250 ml	\$3.15	\$3.60	\$4.50
C	45-6412	600 ml	\$6.30	\$7.20	\$9.00
D	45-6412	1000 ml	\$8.65	\$9.88	\$12.35
E	45-6412	1200 ml	\$10.22	\$11.68	\$14.60



PYREX BEAKER

These beakers are designed to be non-conductive and heat-resistant. Beakers are used to heat solutions during plating. To avoid spillage, beaker covers are available. Covers sold separately.

Item	Order #	Description	Container Volume	12+	6+	1+
F	45-6411	Beaker	250 ml	\$5.44	\$5.76	\$6.40
G	45-6400	Beaker	600 ml	\$10.30	\$10.75	\$11.20
H	45-6410	Beaker	1000 ml	\$19.18	\$20.02	\$20.85
	45-6401	Cover (for 600 ml)		\$5.06	\$5.36	\$5.95
	45-6405	Cover (for 1000 ml)		\$5.47	\$5.71	\$5.95



STAINLESS STEEL BEAKERS

Made of all stainless steel, these beakers are perfect for holding electro-cleaner or used in lieu of a stainless steel anode when a solution requires one. To avoid spillage, beaker covers are available. Covers sold separately.

Item	Order #	Description	Container Volume	12+	6+	1+
J	45-6402	Beaker	600 ml	\$51.57	\$53.81	\$56.05
K	45-6404	Beaker	1200 ml	\$72.40	\$75.55	\$78.70
	45-6401	Cover (for 600 ml)		\$5.06	\$5.36	\$5.95
	45-6405	Cover (for 1200 ml)		\$5.47	\$5.71	\$5.95



PLATING ANODES

Anodes are used for the purpose of introducing electrical current and/or replenishing the metal ions in the plating bath. The stems of all anodes may be bent to hang on the edge of the beakers. There are two types of anodes: **Soluble** - Copper, nickel, and silver anodes dissolve into the bath, replacing metal ions as they are deposited onto the work piece during plating. **Inert** - Our stainless steel and platinum-clad anodes do not dissolve in the plating bath. Prices on anodes will fluctuate due to metal market prices.

Item	Order #	Description	W x L	12+	6+	1+
L	45-0320	Platinized Titanium	¼" x 10¼"	\$50.69	\$52.90	\$55.10
M	45-0321	Platinized Titanium	1" x 4"	\$36.04	\$38.16	\$42.40
N	45-0323	Platinized Titanium	2" x 3"	\$52.36	\$55.44	\$61.60
P	45-0322	Stainless Steel 304	½" x 2"	\$4.55	\$4.75	\$4.95
Q	45-0324	Copper	1" x 6"	\$4.19	\$4.37	\$4.55
R	45-0326	Stainless Steel	1" x 6"	\$5.84	\$6.10	\$6.35
S	45-0330	Nickel	1" x 6"	\$5.98	\$6.24	\$6.50
T	45-0332	Fine Silver	1" x 6"	\$68.31	\$71.28	\$74.25
U	45-0334	24kt Gold	¾" x 1"	\$136.62	\$142.56	\$148.50

SAMSON PEN PLATER

Heavy-duty, high-quality pen platers built for day-in, day-out use. These two amp pen platers employ the latest in technology for dependable results. Available in three models. One-year factory warranty. Made in the USA.

Item	Order #	Description	12+	6+	1+
A	45-4000	Economy Pen Plater	\$101.66	\$107.64	\$119.60
B	45-4001	Standard Pen Plater	\$169.96	\$179.96	\$199.95
C	45-4002	Deluxe Pen Plater	\$237.83	\$251.82	\$279.80

REPLACEMENT PARTS

D	45-4006	Red pen with 1/8" Fiber Tip	\$36.55	\$38.70	\$43.00
D	45-4006	Red Pen with 1/16" Male Fiber	\$36.00	\$38.12	\$42.35
E	45-4007	Black Lead with Clip	\$15.94	\$16.88	\$18.75
F	45-4005	Jar	\$4.51	\$4.77	\$5.30

REPLACEMENT TIPS

G	45-4057	Regular Fiber Tips (Pack of 5)	\$1.98	\$2.06	\$2.15
H	45-4058	Fine-Point Fiber Tips (Pack of 3)	\$2.12	\$2.21	\$2.30

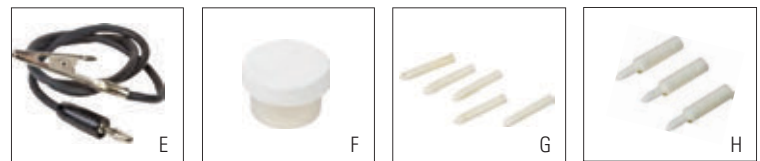
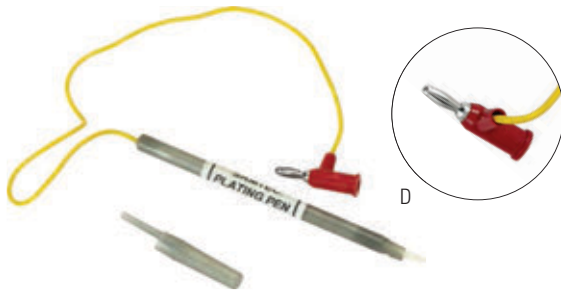

COMPACT PEN PLATER

This compact pen plater does an excellent job and will fill the void for the occasional user of a pen plater. The compact pen plater includes the plating unit, power supply, grounding wire, clip, pen with 1/8" tip, and instructions.

Order #	Description	12+	6+	1+
45-4040	Compact Pen Plater	\$48.62	\$51.48	\$57.20



PLATEMATE DISPOSABLE PEN PLATER

This is the easiest pen plater to use for gold or rhodium. It is small and lightweight so it can be used virtually anywhere. No need for a rectifier, the power source is a battery. Just add your gold or rhodium pen plating solution and you are ready to plate. Each pen will plate up to 90 minutes of continuous plating.

Order #	Description	12+	6+	1+
45-4100	Disposable Pen Plater	\$22.48	\$23.81	\$26.45



EAR POST PROTECTORS

Silicon rubber sleeves to protect ear posts when plating, tumbling, or setting. Excellent for use on surgical steel, gold-filled, karat gold, and sterling silver posts.



Order #	Description	Length	12+	6+	1+
45-0500	Earring Post Protectors	1/2"	\$3.44	\$3.65	\$4.05
45-0501	Earring Post Protectors	5/8"	\$4.04	\$4.28	\$4.75



Find added video content on Stuller.com.



THE WIZARD® DISPOSABLE PEN PLATER

The next generation disposable pen plater is here. A new, sleek, ergonomic stainless steel body, and easily replaceable tips provide 6 volts capacity with no knobs to adjust. This battery operated, completely portable pen plater is great for touch ups and will run for up to an hour of continuous plating.

Order #	Description	12+	6+	1+
45-4070	Wizard Disposable Pen Plater	\$50.15	\$53.10	\$59.00



DELUXE PLATING PEN

- Easy to hold Pen - Titanium head with platinum plating for improved conductivity with the tip. - Flexible wire conductor and insulation on the 36 inch leads. - Replaceable tip - Positive contact pin connector fastens securely with the power source. - Protective cap over the tip for storage. - Attractive appearance continues over time and usage. These characteristics make for easy plating in hard-to-reach areas, development of graphics & designs, touch ups, repairs and more requires rectifier.

Order #	Description	12+	6+	1+
45-4069	Deluxe Plating Pen	\$75.65	\$80.10	\$89.00

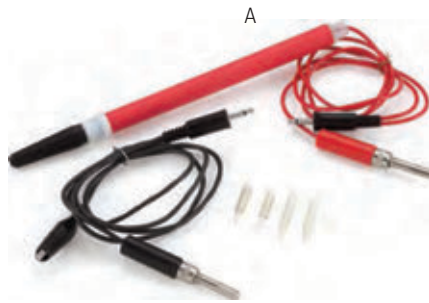

DIGITAL PEN PLATING SYSTEM

- Precise digital voltage regulator
 - Dual voltage, 115V-60Hz, 220V-50Hz
 - Includes three plating pens, three jars, nine felt tips, three bullets, chisel, x-fine

Item	Order #	Description	12+	6+	1+
A	45-4063	3 Yellow Felt-Tip Plating Pen	\$32.00	\$33.89	\$37.65
WAX PEN REPLACEMENT TIPS					
B	45-4067	Chisel (Pack of 10)	\$3.15	\$3.33	\$3.70
C	45-4068	Extra-Fine (Pack of 10)	\$3.61	\$3.83	\$4.25



DIGITAL PLATING SYSTEM

The Neon Digital Pen Plater delivers precise and stable voltage output from 1.2 to 17.6 volts for optimum plating results. LED illumination helps to keep solutions matched with proper pen. Plating pens are designed for this unit only. Includes:

- One plating pen
- Three felt tips
- Three containers
- 115 volt adaptor

Order #	Description	12+	6+	1+
45-4061	Pen Plating System	\$169.15	\$179.10	\$199.00



GREEN STOP-OFF PEN

The most effective means to prevent solder flow. This product has been used by Stuller's own assembly department for many years. Test on a piece of paper before you solder. Shake well then use like a felt-tip marker to mask the areas where you do not want the solder to flow. Use the ultrasonic for cleaning after the solder job is complete.

Order #	Description	12+	6+	1+
54-4039	Green Stop-Off Pen	\$8.63	\$9.14	\$10.15

COPPER PLATING WIRE

Order #	Description	Wire Gauge	Unit Weight	12+	6+	1+
43-6421	Plating Wire	18	4 oz	\$7.65	\$8.10	\$9.00
43-6423	Plating Wire	20	4 oz	\$7.65	\$8.10	\$9.00
43-6422	Plating Wire	21	1 oz	\$7.65	\$8.10	\$9.00
43-6424	Plating Wire	22	4 oz	\$7.65	\$8.10	\$9.00



BRASS PLATING WIRE

All-purpose wire for plating.

Order #	Description	Wire Gauge	Unit Weight	12+	6+	1+
43-5120	Brass Plating Wire	20	4 oz	\$10.63	\$11.09	\$11.55
43-5121	Brass Plating Wire	18	4 oz	\$9.82	\$10.40	\$11.55
43-5122	Brass Plating Wire	22	4 oz	\$9.82	\$10.40	\$11.55



PLATING RACKS

Well designed in rows with numerous hooks, these racks are made of heavygauge, poly-coated copper for protection when immersed in plating baths.

Item	Order #	Diameter	Rows	Hooks	12+	6+	1+
A	45-0400	2"	1	8	\$28.69	\$30.38	\$33.75
B	45-0402	3"	1	12	\$26.39	\$27.95	\$31.05
C	45-0403	3"	2	24	\$41.06	\$43.47	\$48.30

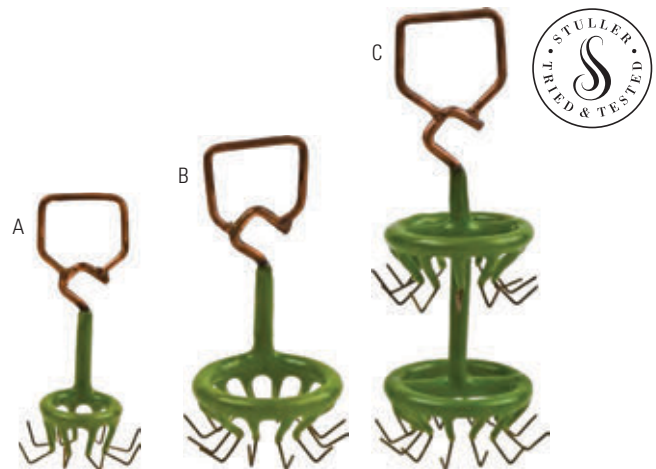

RHODIUM TESTER

Quickly and easily test your rhodium plating solution. Know precisely when to add rhodium replenisher.

Order #	Description	12+	6+	1+
56-7607	Rhodium Tester	\$103.62	\$109.71	\$121.90



RHODIUM CARBON TREATMENT KIT

Excellent for removing organic impurities that cause rhodium plating problems. Easy-to-follow instructions to ensure effective use.

Item	Order #	Description	12+	6+	1+
D	45-4160	Carbon Treatment Kit	\$76.87	\$80.21	\$83.55

REPLACEMENT PARTS

	45-4161	Glass Stirring Rod	\$7.82	\$8.16	\$8.50
	45-4162	Activated Carbon Treatment	\$13.29	\$13.87	\$14.45
E	45-4163	Filter Paper 40 cm (10 Sheets)	\$16.05	\$16.75	\$17.45





A



B



C



D



E

CERAMIT

A two-part, liquid system that produces a ceramic-like surface imitating kiln-fired enamels in appearance and physical properties. Low temperature curing—200°F (93.3°C) for one hour. Catalyst and color are mixed in a 2-to-1 proportion. Brush on, spray on, or apply with a spatula or squeeze bottle. Can be applied in a single coat or successive layers to obtain elegant finishes. Fourteen colors are available, which can be mixed to obtain an infinite variety of shades. Adheres to metals, wood, plastics, and ceramics. Can also be stoned and polished. Hardness of 60-75 on the Sward scale (as compared to kiln-fired enamel 65-80 that requires 1,500°F (815.6°C) to cure). Can be cured in ordinary kitchen ovens, by infrared lamps, or forced air blowers.

Item	Order #	Description	Color	Container Volume	Container Volume		
					12+	6+	1+
A	45-8000	Cerमित™ Kit			\$70.15	\$73.20	\$76.25
B	45-8804	Cerमित™ Thinner		1 pint	\$25.85	\$26.98	\$28.10

CATALYST REFILLS

C	45-8800	Refill		8 oz	\$15.23	\$15.89	\$16.55
D	45-8801	Refill		1 pint	\$29.26	\$30.53	\$31.80
E	45-8802	Refill		1 quart	\$41.77	\$43.58	\$45.40

REPLACEMENT COLORS

45-8001	Opaque	Black	2 oz	\$7.64	\$7.97	\$8.30
45-8003	Opaque	White	2 oz	\$7.64	\$7.97	\$8.30
45-8009	Opaque	Red	2 oz	\$7.64	\$7.97	\$8.30
45-8013	Opaque	Orange	2 oz	\$7.64	\$7.97	\$8.30
45-8016	Opaque	Yellow	2 oz	\$7.64	\$7.97	\$8.30
45-8019	Opaque	Jade	2 oz	\$7.64	\$7.97	\$8.30
45-8024	Opaque	Turquoise	2 oz	\$7.64	\$7.97	\$8.30
45-8041	Transparent	Red	2 oz	\$7.64	\$7.97	\$8.30
45-8043	Transparent	Brown	2 oz	\$7.64	\$7.97	\$8.30
45-8045	Transparent	Yellow	2 oz	\$7.64	\$7.97	\$8.30
45-8046	Transparent	Green	2 oz	\$7.64	\$7.97	\$8.30
45-8047	Transparent	Blue	2 oz	\$7.64	\$7.97	\$8.30
45-8048	Transparent		2 oz	\$7.64	\$7.97	\$8.30
45-8050	Fluorescent	Red	2 oz	\$7.06	\$7.47	\$8.30
45-8051	Fluorescent	Green	2 oz	\$7.06	\$7.47	\$8.30
45-8052	Fluorescent	Blue	2 oz	\$7.06	\$7.47	\$8.30

Individual 2 oz. bottles can be ordered by product numbers listed with colors.

Opaque Colors:



45-8001 Black 45-8003 White 45-8009 Red 45-8013 Orange



45-8016 Yellow 45-8019 Jade 45-8024 Turquoise

Transparent Colors:



45-8041 Red 45-8043 Brown 45-8045 Yellow



45-8046 Green 45-8047 Blue 45-8048 Clear

Fluorescent Colors:



45-8050 Red 45-8051 Green



45-8052 Blue

U-NAMEL UV CURED ENAMEL SYSTEM

The U-Name! ultraviolet enamel application system cures in 1-2 minutes. Once cured the enamel becomes scratch and wear resistant. It will not chip, flake, peel, or shrink. The cured enamel is easily drilled, grinded, polished, carved, and sanded. The easy-to-mix colors won't fade and can be inlaid into metal, glass, plastic, and ceramic. The enamels will adhere to flat surfaces and can be layered to create cabochons. The kit includes 5-7 gram jars of enamel in popular colors, bonding primer, UV lamp, safety goggles, and syringe with tips. This product is non-hazardous.

Starter Kit includes:

- 5-7 gram tubs in the following colors: black, white, red, blue and yellow
- Curing light
- Safety goggles
- Mixing pad
- Bond liquid
- Mixing/application tool
- Reusable syringe with 5 tips



Item	Order #	Description	12+	6+	1+
A	45-8060	UV Cured Enamel System	\$131.74	\$137.47	\$143.20

ACCESSORIES

B	45-8062	Bond Liquid	\$15.04	\$15.70	\$16.35
C	45-8063	Curing Light	\$28.15	\$29.38	\$30.60
D	45-8064	Mixing Pad	\$1.52	\$1.58	\$1.65
E	45-8065	Brushes	\$3.77	\$3.94	\$4.10
F	45-8066	Glasses	\$5.66	\$5.90	\$6.15
G	45-8067	Cloth	\$1.89	\$1.97	\$2.05
H	45-8068	Gloss Liquid	\$9.38	\$9.79	\$10.20

REPLACEMENT COLORS

45-8061	Green	\$15.04	\$15.70	\$16.35
45-8061	Black	\$15.04	\$15.70	\$16.35
45-8061	Red	\$15.04	\$15.70	\$16.35
45-8061	Yellow	\$15.04	\$15.70	\$16.35
45-8061	Pearl	\$15.04	\$15.70	\$16.35
45-8061	Clear	\$22.54	\$23.52	\$24.50
45-8061	White	\$15.04	\$15.70	\$16.35
45-8061	Blue	\$15.04	\$15.70	\$16.35

U-NAMEL

A new method of enameling utilizing fast curing ultraviolet sensitive material.

ADVANTAGES:

- Scratch, wear and shock resistant surface
- Does not chip, crack, flake, peel, or shrink
- Easy to drill, grind, polish, carve, sand, and turned at high speeds
- Sold in 7 gram jars which can be transferred into the supplied UV syringe for application on flat or curved surfaces, or used directly
- Easy-to-mix colors that won't fade

USES:

- Inlaid into precious or non-precious metal, glass, plastic, ceramic, enamel, or U-NAMEL
- Can be layered to make cabachons
- Can be used next to other U-NAMEL or mixed to make interesting designs

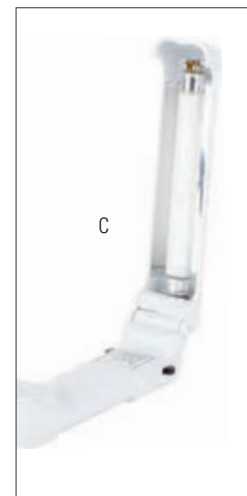



Use with pen platers on pages 392.

RHODIUM PLATING SOLUTION

Super Bright-white rhodium for plating. No mixing required—ready to use. Concentrated formula produces bright-white finish, which reduces tarnish. Acid based. Approximate 8-9 month shelf life. Prices will fluctuate according to rhodium market. Hazardous material, must ship UPS Ground.

Item	Order #	Plating	Rhodium Volume	Container Volume	1+
A	45-4142	Bath	1 gram	1 pint	Call for pricing
B	45-4143	Bath	2 gram	1 pint	Call for pricing
C	45-4141	Bath	½ gram	½ pint	Call for pricing
D	45-4147	Pen	1 gram	25 ml	Call for pricing
E	45-4140	Pen	½ gram	25 ml	Call for pricing
F	45-4145	Pen	¼ gram	1 oz	Call for pricing
G	45-4154	Pen	1 gram	50 ml	Call for pricing
H	45-4146	Pen	½ gram	125 ml	Call for pricing



RHODIUM BATH KIT CONCENTRATE

Concentrate for pen plating. Perfect for touch-ups and small intense jobs. Follow mixing instructions. Prices will fluctuate according to rhodium market.

Item	Order #	Rhodium Volume	Container Volume	1+
J	45-4152	½ gram	½ pint	Call for pricing
K	45-4153	1 gram	½ pint	Call for pricing



SUPER BLACK RHODIUM PLATING SOLUTION

Black rhodium plating solution provides a long-lasting, tarnish-resistant gray-black finish. Use with a platinized titanium anode or carbon anode. Prices will fluctuate according to the rhodium market. Hazardous material, must ship UPS Ground.

Item	Order #	Plating	Rhodium Volume	Container Volume	1+
L	45-4148	Pen	¼ gram	1 oz	Call for pricing
M	45-4149	Pen	½ gram	25 ml	Call for pricing
N	45-4150	Bath	1 gram	1 pint	Call for pricing



TWL BLACK RHODIUM BATH KITS

Rhodium plating additive solution is mixed with rhodium concentrate to produce a black rhodium bath with long lasting black metallic color.

Item	Order #	Description	1+
P	45-4191	1g Black Rhodium Bath Kit	Call for pricing
	45-4190	2g Black Rhodium Bath Kit	Call for pricing
Q	45-4195	½ g Black Rhodium Bath Life Extender	Call for pricing
R	45-4194	Stabilizer	Call for pricing



CLEAN EARTH PLATING SOLUTIONS

All Clean Earth™ plating solutions are cyanide-free. They are ecologically safer than standard plating solutions yet plate uniformly and produce a hard, durable finish. Used in bath plating.

Item	Order #	Description	Container Volume	1+
A	45-2220	Nickel-Free	4 quarts	\$43.85
B	45-2100	Nickel Mirror	4 quarts	\$38.20
C	45-2200	Silver-Free	4 quarts	\$100.00
D	45-2060	Copper Primer	4 quarts	\$33.75
E	45-2080	Copper Mirror	4 quarts	\$33.75
F	45-2260	Black-Free	4 quarts	\$39.35



CLEAN EARTH PLATING SOLUTIONS

All Clean Earth™ plating solutions are cyanide-free. They are ecologically safer than standard plating solutions yet plate uniformly and produce a hard, durable finish. Produces a uniform gold color. Use with a stainless steel or pure gold anode. Plate with the solution heated to 140°F (60°C) at 3-4 volts for 30-45 seconds. A change in the plating time will affect the color. Used in bath plating.

Item	Order #	Description	Container Volume	1+
G	45-2120	14kt Gold	1 quart	Call for pricing
H	45-2140	18kt Gold	1 quart	Call for pricing
J	45-2160	24kt Gold	1 quart	Call for pricing



CLEAN EARTH PEN PLATING

Clean Earth™ is a resilient gold plating solution that deposits a flash plate of gold over nickel, sterling silver, gold, rhodium, and most other similar metals. Cyanide-free.

Item	Order #	Description	Container Volume	1+
K	45-2500	14kt Gold	1 fluid oz	\$94.40
L	45-2510	18kt Gold	1 fluid oz	\$94.40
M	45-2520	24kt Gold	1 fluid oz	\$94.40
N	45-2530	24kt Rose Gold	1 fluid oz	\$94.40



Pricing on plating solutions containing precious metals will fluctuate with the metal market.

CLEAN EARTH™

Gold Plating Produces a uniform gold color. Use with stainless steel or pure gold anode. Plate with the solution heated to 140°F (60°C) at 3-4 volts for 30-45 seconds. Changing the plating time or solution temperature will affect the color.

Silver Produces a uniform silver plate. Use with stainless steel or pure silver anode. Plate with the solution at room temperature at 1.4-1.8 volts for 15-90 seconds. The finish will reflect the surface of the underplate; shiny silver over shiny metals and matte silver over a dull surface.

Nickel Mirror Adds a decorative brilliance and a white mirror shine to dull finishes. Best if used over Copper Mirror. An excellent base for rhodium, gold, or silver plating. Use with pure nickel anode. Plate with solution at 140°F (60°C) at 2-4 volts for 2-10 minutes.

Nickel-Free A nickel-free alloy similar in color to nickel. Best if used over Copper Mirror. An excellent base for gold and silver plating. Use with nickel anode. Plate with solution 140°F (60°C) at 2-4 volts for 30-90 seconds.

Copper Primer Used as a pre-plate to cover difficult to plate metals such as tin, lead, and zinc, die-cast metals. A excellent base for nickel plating. Use with a pure copper anode. Plate with solution at 130°F (54°C) at 1-2 volts for 2-5 minutes.

Copper Mirror Produces a bright copper finish. Air bubble agitation produces superior uniformity and shine. Use with a pure copper anode. Plate with solution at room temperature at 2-3 volts for 2-10 minutes. Electroform at 1-1.3 volts for 30 minutes to 5 hours.

White-Free Deposits a beautiful bright, white finish. Best if used over Nickel Mirror or Copper Mirror. Use a stainless steel anode. Plate with a solution at room temperature at 2-4 volts for 30-60 seconds.

Black-Free Use to achieve an antique finish. After article is plated with Black-Free, highlights are relieved by polishing. Use with a stainless steel anode. Plate with solution at 120°F (50°C) at 3-6 volts for 30-90 seconds.



CLEAN EARTH ELECTROCLEANER

A quick and effective method of cleaning objects prior to plating. The cleaning process uses an electrolytic bath, similar to plating operations. (The 2lb size makes 8 gallons; 5lb size makes 20 gallons.) Use with a stainless steel anode. Clean with the solution heated from 120°-160°F (50°-71°C) at 2-6 volts for 15-30 seconds.

Item	Order #	Size	12+	6+	1+
A	45-2020	2 lb container (makes 8 gallons)	\$18.02	\$19.08	\$21.20
B	45-2030	5 lb container (makes 20 gallons)	\$39.28	\$40.99	\$42.70



CLEAN EARTH STRIP-FREE

Used to strip gold plating. Reverse plate with the solution heated to 130°-150°F (50°-65°C) at 3-6 volts for 30-90 seconds. Use with a stainless steel anode.

Order #	Size	12+	6+	1+
45-2180	1 quart	\$19.64	\$20.50	\$21.35



CLEAN EARTH ACTIVATOR

This powdered acid is mixed with water to produce a mild solution for etching, brightening, and cleaning. Use to clean and activate parts to assure strong metallic bonding throughout the subsequent plating process. Use at room temperature for 30-60 seconds. Excellent results for rhodium plating when used after electrocleaning step and before rhodium bath. *Note: This solution is not used with a rectifier.*

Order #	Size	12+	6+	1+
45-2040	2 lb	\$18.31	\$19.10	\$19.90



CLEAN EARTH SS ACID ACTIVATOR

Clean Earth™ Stainless Steel Acid Activator is a powerful activator that provides excellent oxide removal and etching properties to help metals plate onto stainless steel. Clean Earth™ Stainless Steel Acid Activator offers a low cost, easily maintainable and ecological alternative to hazardous and noxious acids. This activator is designed to activate stainless steel for gold plating with Clean Earth™ Gold Plating Solution, for complete cyanide free process.

Order #	Size	12+	6+	1+
45-2010	1 quart	\$70.01	\$75.92	\$84.35



STULLER-GLO CYANIDE-FREE PEN PLATING SOLUTION

This unique Stuller-Glo™ pen plating solution deposits beautiful gold colors easily and is a fully cyanide-free, ecological solution. Packaged in double walled jars with a wide base to help prevent spills. Non-poisonous, cyanide-free chemicals means it does not incur the higher shipping charges that other hazardous materials do. A 1 ounce bottle can generally cover approximately 1,000 square inches. Works with all pen platers.

Order #	Description	Size	1+
41-4150	14kt Pen Plating Solution	1 oz jar	\$51.70
41-4155	18kt Pen Plating Solution	1 oz jar	\$51.70
41-4160	24kt Pen Plating Solution	1 oz jar	\$51.70
41-4165	Rose Pen Plating Solution	1 oz jar	\$51.70



ACID NEUTRALIZER

Stops the pickling process when applied directly to an object; will also neutralize pickling solutions.



Order #	Size	12+	6+	1+
54-5005	6 oz	\$4.05	\$4.22	\$4.40



PALLADIUM PLATING SOLUTION

Easy-to-use, cyanide-free, and ecologically friendly, this tarnish-resistant bright white palladium bath provides uniform plating from start to finish. This product produces a consistent bright white mirror finish. It can be used as an intermediate layer over gold, silver, palladium, and platinum, as well as a final plate over low-end jewelry. Non-hazardous shipping.

Order #	Rhodium Volume	Size	1+
45-4179	2½ gram	1 quart	Call for pricing



ELECTRO CLEANER

A quick and effective method of cleaning objects prior to plating. The cleaning process uses an electrolytic bath, similar to plating operations. Clean with the solution heated from 120°-160°F (50°-71°C) at 2-6 volts at 15-30 seconds. Use with a stainless steel anode.



Order #	Size	12+	6+	1+
45-0312	1 quart	\$10.58	\$11.04	\$11.50



STOP-OFF BLUE

A very effective solution that may be used to mask areas that do not need to be plated. May be cleaned after use with acetone. Use with a red sable brush.



Order #	Description	12+	6+	1+
45-4155	Stop-Off Blue	\$16.97	\$18.41	\$20.45



SILVER BLACK

An acid-based oxidizer that produces an instantaneous deep black patina on silver, gold, copper, or bronze.



Item	Order #	Size	12+	6+	1+
A	54-5030	1 oz	\$3.77	\$3.94	\$4.10
B	54-5031	4 oz	\$7.68	\$8.02	\$8.35
C	54-5033	16 oz	\$21.93	\$23.22	\$25.80



GROBET USA® LACQUER AND LACQUER STRIPPER

Lacquer protects metal surfaces from scratches and tarnish. To remove lacquer from metal surfaces to Lacquer Stripper, which can also be used to thin lacquer.



Item	Order #	Description	Size	12+	6+	1+
G	45-7990	Lacquer	8 oz	\$14.08	\$14.69	\$15.30
H	45-7995	Lacquer Stripper	8 oz	\$10.21	\$10.66	\$11.10



XL GEL SOLUTION

Liver of Sulphur XL Gel is formulated for extended shelf life, versatility, and convenience. XL gel is used to patina metals, such as silver, copper, bronze, etc. Its shelf life is many times that of dry liver of sulphur and is non-flammable. Easy-to-use squeeze bottles.

Item	Order #	Size	12+	6+	1+
N	45-4997	1 oz	\$7.31	\$7.63	\$7.95
P	45-4998	2 oz	\$11.36	\$11.86	\$12.35



LIVER OF SULPHUR

The most effective oxidizer for silver. This product is used to permanently "antique" silver and copper. It will not rub off or disappear during ultrasonic or steam cleaning. This product is NOT suitable for antiquing gold.



Item	Order #	Description	Size	12+	6+	1+
D	45-5000	Pro-Craft™ Lump Form	8 oz	\$16.51	\$17.23	\$17.95
E	45-5002	Griffith	4 oz	\$10.67	\$11.14	\$11.60
F	45-5004	Griffith	8 oz	\$18.31	\$19.10	\$19.90



DENATURED ALCOHOL

For use in alcohol lamps, making anti-oxidizers, and as a quick-drying dip to prevent spotting of plated pieces. Flammable, ships UPS Ground only.

Item	Order #	Size	12+	6+	1+
J	54-8040	8 oz	\$3.86	\$4.03	\$4.20
K	54-8041	16 oz	\$6.53	\$6.82	\$7.10
L	54-8042	32 oz	\$8.46	\$8.83	\$9.20
M	54-8043	1 gallon	\$25.85	\$26.98	\$28.10



ANTIQUING SOLUTION

Provides a dark, matte, antique finish to class rings or any other jewelry. Adheres to metal and dries in minutes. High spots can be wiped clean with Aul Solvent (removes background color) and a lint-free cloth. The background solution is resistant to wear and needs no lacquer.



Item	Order #	Description	Size	12+	6+	1+
Q	45-0130	Antique Black	2 oz	\$10.35	\$10.80	\$11.25
R	45-0132	Antique Brown	2 oz	\$16.79	\$17.52	\$18.25
S	45-0135	Aul Solvent	2 oz	\$10.35	\$10.80	\$11.25



Find added video content on Stuller.com.

The main features of this electrolyte are as follows:

- Flash rhodium-plating until 0.5 microns
- Exceptional brilliant white deposits
- Wider plating range of voltage and amperage
- Possible to use at room temperature
- Good distribution and penetration power
- Exceptional coverage and deposition speed

LEGOR ULTRABRIGHT RHODIUM PLATING SOLUTION

Ultrabright Rhodium is a ready-to-use anti-burn rhodium plating bath with exceptional features. The properties of the deposit and its degree of whiteness make this plating bath a point of reference for the worldwide market. The higher degree of whiteness is due to a more compact deposition with respect to those achieved with the other white rhodium solutions in the market. As a result, a higher white will be achieved at the same working time.

Order #	Description	Rhodium Volume	1+
45-2230	Ultrabright Bath Plating, 500ml	1 g	Call for pricing
45-2230	Ultrabright Bath Plating, 1L	2 g	Call for pricing



Find added video content on Stuller.com.

The main characteristics of this electrolyte are:

- Extremely brilliant blue deposits
- Can be used at room temperature.

LEGOR BLUE RHODIUM PLATING SOLUTION

Ultrabright Blue Rhodium is a galvanic solution containing 2 g of Rh/500 ml of ready-to-use solution for blue rhodium decoration by immersion. RH2BLUE has been specifically developed for decorative application on the surface of precious metals and small non-ferrous items.

Order #	Description	Rhodium Volume	1+
45-2231	Ultrabright Blue Rhodium, 500ml	2 g	Call for pricing



- Perfect functioning even at low gold concentration
- Wide current flow range
- Excellent distribution
- Low density gold deposits
- Easy to control and to maintain
- Calibrated to meet the new EU low-nickel-release laws (UNI EN 1811:2011)

LEGOR GOLD THICKNESS BATH PLATING SOLUTION

The GT Gold Plating Series is composed of weak acidic solutions designed to achieve thickness of up to 2 microns. GT solutions present the perfect ready-to-use answer to manufacturers who are looking to obtain a solid gold layer of metallic surfaces. The GT series products allow you to obtain hard, brilliant gold depositions of 22.5-24 karat, with an excellent wear and corrosion resistance.

Order #	Description	Rhodium Volume	1+
45-2232	14kt Bath Plating Solution, 1L	2 g	Call for pricing
45-2232	18kt Bath Plating Solution, 1L	2 g	Call for pricing
45-2232	18kt Bath Plating Solution, 1L	2 g	Call for pricing



Find added video content on Stuller.com.

LEGOR BLUE RHODIUM PEN PLATING SOLUTION

Blue rhodium is a perfect option to add color to metallic surfaces while maintaining the precious aspect of the design. Most commonly used for plating the prong area to enhance the color of blue stones. This room temperature procedure makes it ideal for two-tone designs. The newly developed formula has proven to be one of the most stable on the market today.

Order #	Description	1+
45-2234	Blue Rhodium Pen Plating, 25ml	Call for pricing
45-2234	Blue Rhodium Pen Plating, 50ml	Call for pricing
45-2234	BlueRhodium Pen Plating, 100ml	Call for pricing

LEGOR GOLD FLASH BATH PLATING SOLUTION

The GF gold plating series has been designed for flash plating of up to 0.2 microns. This series is cyanide free and ready-to-use. The GF series is both nickel and cadmium free.

Order #	Description	Rhodium Volume	1+
45-2233	Pink Bath Plating, 1L	1 g	Call for pricing
45-2233	Brown Bath Plating, 1L	0.8 g	Call for pricing



Find added video content on Stuller.com.



Pink Bath Plating Solution

- Cyanide free flash gold plating
- Working temperature: 50-60C
- Good penetrating power
- Good distribution

Brown Bath Plating Solution

- Light Brown color plating
- Non-toxic product, cyanide free flash gold plating
- Easy to use

LEGOR PALLADIUM PLATING SOLUTION

Legor Palladium Plating Solution is a ready-to-use palladium plating bath purposely designed for both flash plating and thick deposits. It is suitable for the treatment of those details that requires the deposition of pure palladium and it is characterized by the high resistance and robustness of the galvanic deposit which makes it particularly suitable either as a finish in itself, or as a barrier layer plating process especially between copper or its alloy and gold. Besides, thanks to its characteristics, this bath is particularly suitable for nickel-free finishing systems.

Order #	Description	Palladium Volume	1+
45-2235	Palladium Plating Solution, 1L	8 g	Call for pricing



- Extremely white, bright, levelled deposits
- Good for both flash plating and thick deposits
- High plating speed
- Easy to control
- Very low toxicity
- Good corrosion tolerance
- Optimum performance as barrier layer especially between copper and gold
- Good tolerance to contaminant metals

LEGOR PLATINUM PLATING SOLUTION

Legor Platinum Plating Solution decoration process is designed to be very easy to use. Its characteristics and the very high thickness uniformity make it a unique product. PT4 is an acid galvanic solution, but it is neither corrosive, nor dangerous to use.

Order #	Description	Platinum Volume	1+
45-2236	Platinum Plating Solution, 1L	4 g	Call for pricing



- Brilliant, uniform platinum layers
- Good penetrating power
- Excellent distribution
- Easy to use



Plating Supplies



IMMERSION THERMOMETER

Indispensable for proper rhodium and palladium plating. Use to determine solution temperature. Temperature range 1-230°F.

Order #	Description	12+	6+	1+
45-6420	Immersion Thermometer	\$38.59	\$40.86	\$45.40



DISPOSABLE LATEX GLOVES

These high-grade, expandable latex gloves are thin to allow good finger sensitivity and excellent dexterity but are tough enough to protect your hands from dirt, grit, and harsh chemicals. Excellent to use during buffing or polishing. Gloves fit either hand.



Order #	Description	12+	6+	1+
17-0745	Disposable Latex Gloves, Small	\$13.75	\$14.35	\$14.95
17-0746	Disposable Latex Gloves, Medium	\$13.75	\$14.35	\$14.95
17-0747	Disposable Latex Gloves, Large	\$10.76	\$11.23	\$11.70



POWDER-FREE BLUE NITRILE GLOVES

Offer better tactile sensitivity, comfort, dexterity, and puncture resistant than both rubber or vinyl. These powder-free gloves are made stronger through a process called fusion bonding, which integrates synthetic polymers into the material to create a multi-layer glove or enhanced protection.

Measures 4.4 mil (palm) and 4.7 mil (fingers) thickness/9 1/2" length.

Order #	Description	12+	6+	1+
17-0846	Small	\$13.80	\$14.40	\$15.00
17-0846	Medium	\$13.80	\$14.40	\$15.00
17-0846	Large	\$11.32	\$11.81	\$12.30
17-0846	Extra-Large	\$13.80	\$14.40	\$15.00



NEOPRENE PLATING APRON

Durable neoprene apron designed to protect against chemical spills during plating and other applications.

Order #	Description	W x L	12+	6+	1+
47-3068	Apron	36" x 43"	\$18.40	\$19.20	\$20.00



NEOPRENE GLOVES

Neoprene gloves provide superior quality and durability as well as protection against acids, caustics, oils, greases, and many solvents. Excellent all-around protection for plating. Black neoprene 14" coated gloves with knit lining. One size fits all.



Order #	Description	12+	6+	1+
22-7508	Neoprene Gloves	\$15.50	\$16.18	\$16.85



TRONEX PRECISION PLIERS

- Bearing ring lap joint design that insures superior performance to other pliers made with only rivet joints or box joints
- Cushion grips (ESD safe) with stainless steel leaf springs
- Choice of standard handle length or long ergonomic handle length
- Polished, hand-crafted finish, entirely free of burrs or sharp edges
- 100% quality assurance; each pliers individually checked; one year factory guarantee
- Special design elements such as "slightly rounded" inner jaw edges and induction hardened tips
- Short jaw pliers have induction hardened tips
- Made in the USA

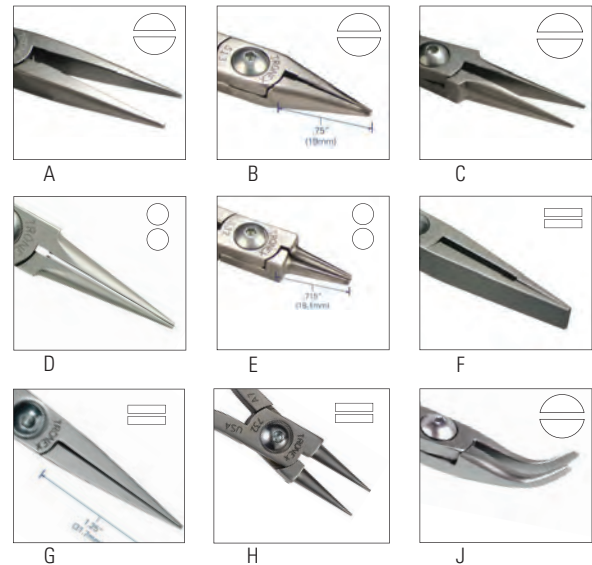

Find added video content on Stuller.com.

LONG HANDLE

Item	Order #	Description	Length	12+	6+	1+
A	46-0001	Chain Nose - Smooth Jaw	6½"	\$40.25	\$42.62	\$47.35
B	46-0002	Chain Nose - Short Smooth Jaw	6"	\$40.25	\$42.62	\$47.35
C	46-0003	Needle Nose	6½"	\$33.70	\$35.69	\$39.65
D	46-0004	Round Nose	6½"	\$40.25	\$42.62	\$47.35
E	46-0005	Round Nose - Short Jaw	6"	\$40.25	\$42.62	\$47.35
F	46-0006	Flat Nose - Step Tip	6½"	\$40.25	\$42.62	\$47.35
G	46-0007	Flat Nose - Smooth Jaw	6½"	\$40.25	\$42.62	\$47.35
H	46-0008	Flat Nose - Short Smooth Jaw	6"	\$40.25	\$42.62	\$47.35
J	46-0009	Bent Nose	6"	\$41.18	\$43.61	\$48.45



Find added video content on Stuller.com.

STANDARD HANDLE

Item	Order #	Description	Length	12+	6+	1+
K	46-0010	Chain Nose - Smooth Jaw	5½"	\$37.44	\$39.65	\$44.05
L	46-0011	Chain Nose - Short Smooth Jaw	5"	\$37.44	\$39.65	\$44.05
M	46-0012	Needle Nose	5½"	\$37.44	\$39.65	\$44.05
N	46-0013	Round Nose	5½"	\$37.44	\$39.65	\$44.05
P	46-0014	Round Nose - Short Jaw	5"	\$37.44	\$39.65	\$44.05
Q	46-0015	Flat Nose - Step Tip	5½"	\$37.44	\$39.65	\$44.05
R	46-0016	Flat Nose - Smooth Jaw	5½"	\$39.31	\$41.63	\$46.25
S	46-0017	Flat Nose - Short Smooth Jaw	5"	\$39.31	\$41.63	\$46.25
T	46-0018	Bent Nose	5"	\$40.25	\$42.62	\$47.35

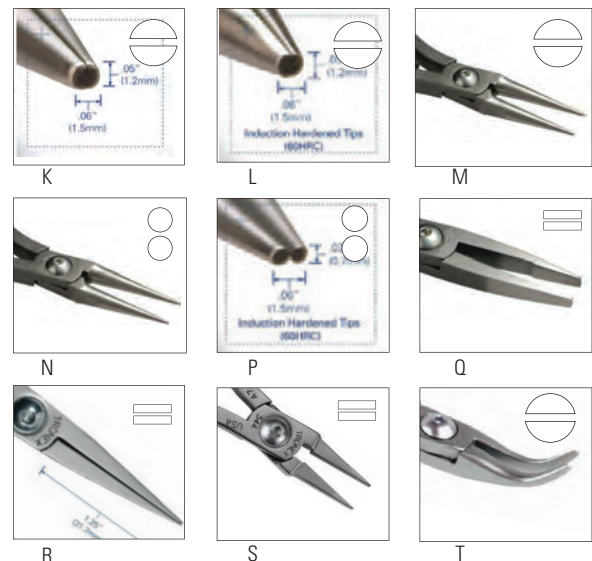

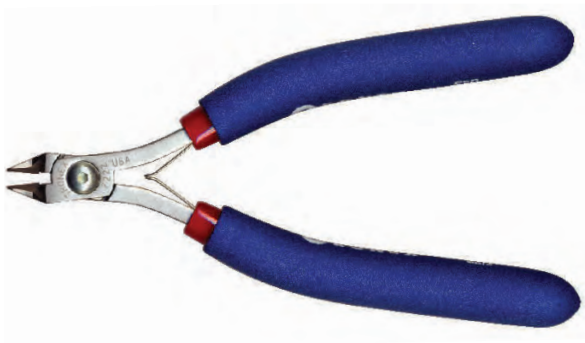

TRONEX CUTTERS - OVAL AND TAPERED HEAD LONG ERGONOMIC HANDLE

- Superior cutting performance, cutting edge hardness
- 100% quality assurance, each cutter individually checked; one year guarantee
- Unique lap joint design with matched bearing rings, Delrin washer, extra sturdy nut, and fine-pitched screw
- Cushion grips with choice of standard or long, ergonomic handle length
- Razor Flush® edges provide exceptional flush cuts
- Made in the USA



Item	Order #	Description	Model #	Length	Cutting Edge	Cutting Capacity	12+	6+	1+
A	46-0019	Mini Oval	7312	7"	Flush	0.1mm-1.25mm, 38-16 AWG	\$43.05	\$45.59	\$50.65
B	46-0023	Large Oval	7512	7"	Flush	.15mm-1.5mm, 35-15 AWG	\$41.18	\$43.61	\$48.45

Pliers, Cutters, and Shears



TRONEX OVAL CUTTER - SEMI-FLUSH

Superior cutting performance, cutting edge hardness. 100% quality assurance, each cutter individually checked; one year guarantee. Unique lap joint design with matched bearing rings, derlin washer, extra sturdy nut, and fine-pitched screw. Cushion grips with with choice of standard or long, ergonomic handle length. Razor Flush® edges provide exceptional flush cuts. Made in the USA.

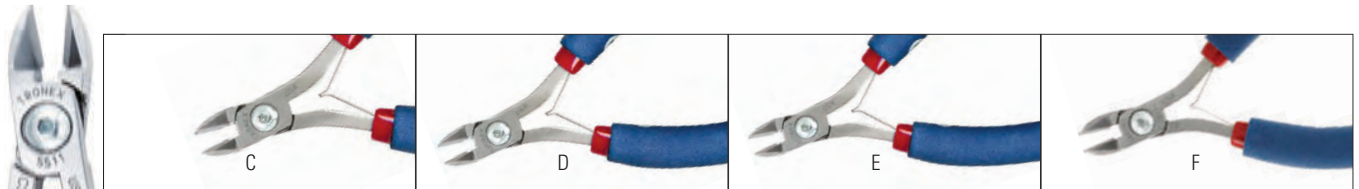

Item	Order #	Description	Model #	Length	Cutting Edge	Cutting Capacity	12+	6+	1+
C	46-7895	Standard Oval	5111	5"	Semi Flush	.2mm -1.25mm, 32 AWG -16 AWG	\$41.65	\$44.10	\$49.00
D	46-7896	Long Oval	7111	7"	Semi Flush	.2mm -1.25mm, 32 AWG -16 AWG	\$43.14	\$45.68	\$50.75
E	46-7897	Large Oval	5511	5"	Semi Flush	.2mm -1.5mm, 32 AWG -15 AWG	\$43.86	\$46.44	\$51.60
F	46-7898	Large Oval	7511	7"	Semi Flush	.2mm -1.5mm, 32 AWG -15 AWG	\$45.48	\$48.15	\$53.50



TRONEX CUTTERS - OVAL AND TAPERED HEAD STANDARD ERGONOMIC HANDLE

- Superior cutting performance, cutting edge hardness
- 100% quality assurance, each cutter individually checked; one year guarantee
- Unique lap joint design with matched bearing rings, Delrin washer, extra sturdy nut, and fine-pitched screw
- Cushion grips with choice of standard or long, ergonomic handle length
- Razor Flush® edges provide exceptional flush cuts
- Made in the USA

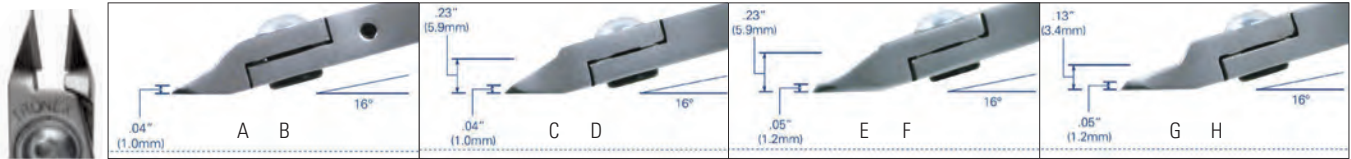

Item	Order #	Description	Model #	Length	Cutting Edge	Cutting Capacity	12+	6+	1+
A	46-0035	Mini Oval	5312	5"	Flush	.1mm-1.25mm, 38-16 AWG	\$41.18	\$43.61	\$48.45
B	46-0036	Mini Oval	5313	5"	Razor Flush	.1mm-.08mm, 38-20 AWG	\$44.92	\$47.57	\$52.85
C	46-0037	Oval Head	5112	5"	Flush	.15mm-1.25mm, 35-16 AWG	\$37.44	\$39.65	\$44.05
D	46-0038	Oval Head	5113	5"	Razor Flush	.1mm-1mm, 38-18 AWG	\$41.18	\$43.61	\$48.45
E	46-0039	Large Oval	5512	5"	Flush	.15mm-1.5mm, 35-15 AWG	\$39.31	\$41.63	\$46.25
F	46-0040	Large Oval	5513	5"	Razor Flush	.1m-1.3mm, 38-16 AWG	\$42.12	\$44.60	\$49.55
G	46-0041	Large Oval Relief	5522	5"	Flush	.15mm-1.4mm, 35-15 AWG	\$41.18	\$43.61	\$48.45
H	46-0042	Large Oval Relief	5523	5"	Razor Flush	.1mm-1.2mm, 38-16 AWG	\$44.92	\$47.57	\$52.85

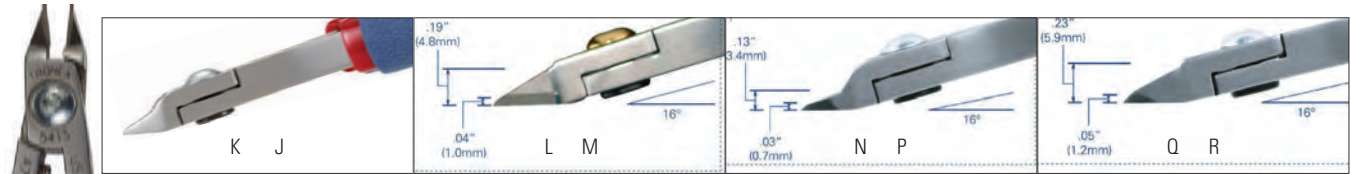

Item	Order #	Description	Model #	Length	Cutting Edge	Cutting Capacity	12+	6+	1+
J	46-0043	Mini Taper Head	5412	5"	Flush	.1mm-1.25mm, 38-16 AWG	\$41.18	\$43.61	\$48.45
K	46-0044	Mini Taper Head	5413	5"	Razor Flush	.1mm-.08mm, 38-20 AWG	\$45.86	\$48.56	\$53.95
L	46-0045	Taper Head	5212	5"	Flush	.15mm-1.25mm, 35-16 AWG	\$39.31	\$41.63	\$46.25
M	46-0046	Taper Head	5213	5"	Razor Flush	.1mm-1mm, 38-18 AWG	\$43.05	\$45.59	\$50.65
N	46-0047	Taper Relief	5222	5"	Flush	.1mm-1.2mm, 35-15 AWG	\$48.66	\$51.53	\$57.25
P	46-0048	Taper Relief	5223	5"	Razor Flush	.1mm-.08mm, 38-18 AWG	\$55.25	\$58.50	\$65.00
Q	46-0049	Large Taper	5712	5"	Flush	.15mm-1.4mm, 35-16 AWG	\$42.12	\$44.60	\$49.55
R	46-0050	Large Taper	5713	5"	Razor Flush	.1mm-1.2mm, 38-16 AWG	\$44.92	\$47.57	\$52.85

LONG HEAVY DUTY CUTTERS

This cutter, forged of carbon steel, has strength in the head and joint areas needed to cut heavier gauge wire or cable. Cushion grips provide operator comfort. A jaw restraining device is attached to insure spring retention.

Order #	Handle/Edge	Cutting Capacity	12+	6+	1+
46-0053	Standard/Flush	12 AWG (2mm)	\$42.12	\$44.60	\$49.55
46-0054	Long/Flush	14 AWG (1.6mm)	\$52.45	\$55.53	\$61.70



TEBORG DIAGONAL CUTTERS

The finest cutters at the best price. Known as side cutters, they have semi-finished cutting edges for precision wire cutting of soft wires. Cushion grip provides comfort and retains precision alignment. Rockwell hardness, hardened and treated handles. Made in Sweden.



A B C



D E



F G



Item	Order #	Description	Length	12+	6+	1+
A	46-6010	Micro-Bevel	4 1/3"	\$33.70	\$35.69	\$39.65
B	46-6011	Small Pure Flush Cut	4 1/3"	\$45.86	\$48.56	\$53.95
C	46-6012	Micro-Bevel	4 7/16"	\$34.21	\$36.23	\$40.25
D	46-6013	Medium Flush Cut	4 7/16"	\$43.82	\$46.40	\$51.55
E	46-6014	Flush Cut	4 1/3"	\$34.21	\$36.23	\$40.25
F	46-6015	Semi Flush Cut	4 5/16"	\$45.86	\$48.56	\$53.95
G	46-6016	Micro-Bevel	5"	\$34.21	\$36.23	\$40.25

Introducing Ergo-tek from Ideal-tek
Red Dot Design Award Winner 2014

New cutters and pliers handles' set a new benchmark in ergonomics. Following the User-Centered Design approach of one of the world's most respected research universities (University of Milan), over a two year period, Ideal-tek gained a full understanding of the needs, wants and frustrations of end users. Subsequent painstaking attention to detail at every stage of the design process resulted in the creation of the ideal handles. Precision Swiss manufacture provides quality, accuracy and longevity. The addition of Italian design brings beauty and elegance.

Ergo-tek. Perfect synergy.





IDEAL-TEK PLIERS

Ideal-Tek Swiss-made pliers feature a very fine tip and smooth or serrated jaws and inner edges. Features high-quality ball bearing steel (63 - 65 Rockwell Hardness [HRC]), pyrometer-controlled inductive hardening, two component ESD ergonomic handles with soft comfortable gripping surface, hard plastic core, dual leaf springs in blue steel, matched bearing rings, and friction lap joint with screw. The nut is made of hardened alloy steel in order to resist high cutting load. The screw is fine-pitched for perfect joint adjustment.

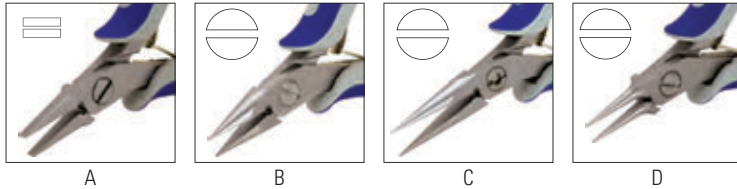

Item	Order #	Description	Length	12+	6+	1+
A	46-7011	Short Flat Nose	5¼"	\$34.51	\$36.54	\$40.60
B	46-7012	Snipe Nose	5¼"	\$37.61	\$39.83	\$44.25
C	46-7013	Snipe Nose Long	5½"	\$37.83	\$40.05	\$44.50
D	46-7014	Round Nose	5¼"	\$36.98	\$39.15	\$43.50

IDEAL-TEK CUTTERS

Ideal-Tek Swiss-made cutters are very slim and are relieved to maximize accessibility. Features high-quality ball bearing steel (63 - 65 Rockwell Hardness [HRC]), pyrometer-controlled inductive hardening, two component ESD ergonomic handles with soft comfortable gripping surface, hard plastic core, dual leaf springs in blue steel, matched bearing rings, and friction lap joint with screw. The nut is made of hardened alloy steel to resist the high cutting load. The screw is fine-pitched for perfect joint adjustment.



Item	Order #	Description	Length	12+	6+	1+
E	46-7000	Oval Micro Relieved Flush	4¾"	\$42.91	\$45.43	\$50.48
F	46-7001	Oval Small Flush	4¾"	\$40.72	\$43.11	\$47.90
G	46-7002	Oval Small Full-Flush	4¾"	\$41.57	\$44.01	\$48.90
H	46-7003	Large Oval Flush	5"	\$43.86	\$46.44	\$51.60
J	46-7004	50° Angle Flush	5¼"	\$40.12	\$42.48	\$47.20
K	46-7005	Tapered Micro Relieved Flush	4¾"	\$42.91	\$45.43	\$50.48
L	46-7006	Tapered Small Flush	4¾"	\$40.72	\$43.11	\$47.90
M	46-7007	Tapered Large Flush	5"	\$43.86	\$46.44	\$51.60
N	46-7008	Tapered Large Full-Flush	5"	\$43.99	\$46.58	\$51.75
P	46-7009	Tapered & Relieved Flush	4¾"	\$40.21	\$42.57	\$47.30
Q	46-7010	Tapered & Relieved Full-Flush	4¾"	\$40.38	\$42.75	\$47.50
R	46-7016	Oval Micro Relieved Full-Flush	4¾"	\$41.57	\$44.01	\$47.50
S	46-7017	Big Oval Semi-Flush	5"	\$41.57	\$44.01	\$48.90
T	46-7018	Big Oval Full-Flush	5"	\$43.99	\$46.58	\$51.75
U	46-7019	Tapered Micro Relieved Full-Flush	4¾"	\$42.30	\$44.79	\$49.77
V	46-7020	Tapered Small Full-Flush	4¾"	\$41.57	\$44.01	\$48.90
W	46-7021	Oval Small	4¾"	\$36.51	\$38.66	\$42.95



Pliers, Cutters, and Shears



A



B



C



D



E



F



G

LINDSTROM® SUPREME SERIES PLIERS

High-quality, extremely precise and accurate pliers. Specially forged box joint provides extra long contact surfaces. Joint moves smoothly for extra precision even at the tip. Box joint allows for smaller overall dimensions, improving accessibility in confined areas. With dual spring-loaded handles and comfortable cushion grips marked with information on pliers' capacity. Made in Sweden.

Item	Order #	Description	Length	Jaw Capacity	Model #	1+
A	46-7190	Side Cutter	4¼"	1½"	7190	\$50.00
B	46-7490	Flat Nose	4¾"	25/32"	7490	\$45.00
C	46-7590	Round Nose	4¾"	25/32"	7590	\$43.00
D	46-7291	Flush Oblique End Cutter	4¼"	19/32"	7291	\$58.00
E	46-7893	Short Chain Nose	4¾"	25/32"	7893	\$44.00
F	46-7892	Long Chain	5¼"	1¼"	7890	\$46.00
G	46-7894	Curved Nose	5"	1½"	7892	\$50.00



H



J



K



L



M



N



P

LINDSTROM® 80 SERIES YELLOW HANDLE CUTTERS

Advanced, diagonal-cutting nippers, screw-type precision, lap joint allows for optimum strength. Handles are dual spring-loaded, and oval jaw design allows ease of use. Made in Sweden.

Item	Order #	Description	Length	Jaw Capacity	Model #	1+
H	46-8140	Small Oval Micro-Bevel	4¾"	3/8"	8140	\$50.00
J	46-8150	Medium Micro-Bevel	4½"	1/2"	8150	\$51.00
K	46-8142	Small Pure Ultra-Flush	4½"	3/8"	8142	\$55.00
L	46-8160	Small Oval Flush	4½"	3/8"	8141	\$53.00
M	46-8152	Medium Ultra-Flush	4½"	1/2"	8152	\$59.00
N	46-8170	Large Oval Micro-Bevel	4½"	5/8"	8160	\$57.00
P	46-8162	Large Oval Ultra-Flush	4½"	5/8"	8162	\$71.00



Q



R

LINDSTROM® NOSE PLIERS

The Lindstrom® round-flat nose pliers are precision-crafted in Switzerland from hardened, high-chromium steel alloy and precision-ground to exact specifications. They are ideal for heavy-gauge metals and harder metals.

Item	Order #	Description	Length	12+	6+	1+
Q	46-7901	Chain Nose	7"	\$52.83	\$55.94	\$62.15
R	46-7900	Round-Flat Nose	7"	\$52.83	\$55.94	\$62.15

REVERE PLIERS

Introducing an exceptional line of quality pliers for the discriminating professional inspired and designed by Alan Revere, a master goldsmith and founder and director of the Revere Academy of Jewelry Arts. Alan's passion for unquestionable quality and the highest standards of workmanship result in a superior line of German-crafted tools made to meet his specifications. Made of highest quality carbon tool steel available. Hand-finished to meet exacting standards. Jaws are hand-finished with beveled corners. No plastic handles or springs for precise control and surface contact. Special tooling is used to create the unique Revere grip. Made in Germany.

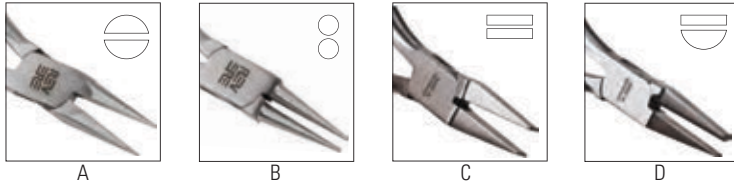

Item	Order #	Description	Length	1+
	46-0399	Revere Kit (4-Pieces)	5"	\$131.00
A	46-0400	Chain Nose	5"	\$36.35
B	46-0401	Round Nose	5"	\$36.35
C	46-0402	Flat Nose	5"	\$36.35
D	46-0403	Flat & Half Flat	5"	\$38.70

BOX-JOINT PLIERS

Quality box-joint pliers at an affordable price. Pliers have a brushed satin finish and smooth, non-marring jaws. Comfortable foam-grip handles with double-leaf spring return.

Item	Order #	Description	Length	12+	6+	1+
E	46-0535	Chain Nose	4¾"	\$6.84	\$7.25	\$8.05
F	46-0536	Round Nose	4¾"	\$6.84	\$7.25	\$8.05
G	46-0537	Flat Nose	4¾"	\$6.84	\$7.25	\$8.05
H	46-0538	Side Cutter	4¾"	\$9.35	\$9.90	\$11.00

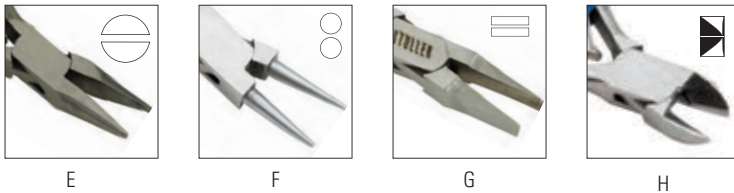

Pliers, Cutters, and Shears

SLIM-LINE PLIERS

User-friendly line of pliers with black comfort grips and fine, precision points are offered at an exceptional price. 5" (127mm) in length with a gentle return spring. Uncompromising quality. The newest in comfort technology with black, oxidized, non-glare finish designed for precision work.

Item	Order #	Description	Length	12+	6+	1+
J	46-1500	Chain Nose	5"	\$7.48	\$7.92	\$8.80
K	46-1503	Side Cutter	5"	\$7.91	\$8.37	\$9.30



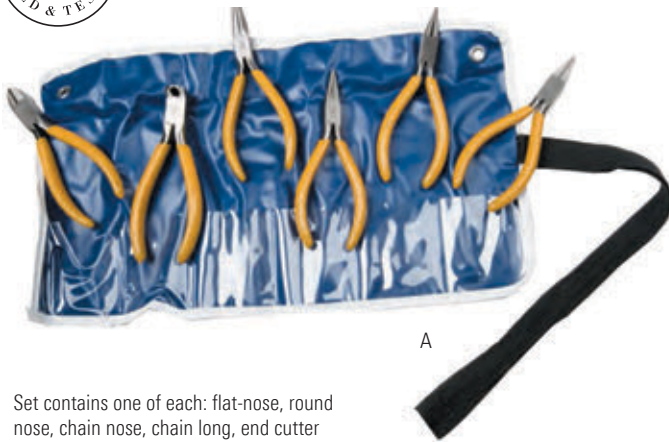

A

Set contains one of each: flat-nose, round nose, chain nose, chain long, end cutter and diagonal cutter in a vinyl pouch.

BOX-JOINT GERMAN PLIERS

Standard weight and size for medium to small work. These are precision pliers and nippers with box joints to eliminate side play and maintain alignment of jaws under stress. Heads are brightly polished, and handles have yellow, vinyl cushion grips.

Item	Order #	Description	Length	1+
A	46-1000	Box Joint Set	5¼"	\$137.75
B	46-1260	Diagonal Cutter	5¼"	\$36.05
C	46-1020	Flat Nose	5¼"	\$25.15
D	46-1040	Round Nose	5¼"	\$25.15
E	46-1200	Flush End Cutter	5¼"	\$33.90
F	46-1060	Short Chain Nose	5¼"	\$25.15
G	46-1100	Long Chain Nose	5¼"	\$27.40
H	46-1080	Serrated Chain Nose	5¼"	\$25.15
J	46-1140	Half-Round Nose/Flat Nose	5¼"	\$28.55

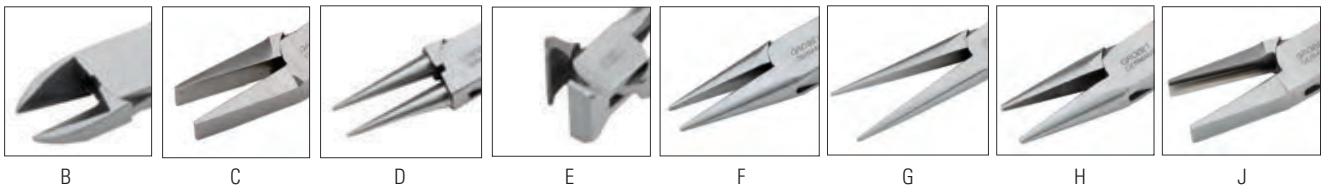

B

C

D

E

F

G

H

J



STULLER COMFORT GRIP PLIERS

Made of the finest tool steel and beautifully polished, with box-joint construction and double-leaf springs, these pliers offer the latest in ergonomic design. The handle width and soft non-slip texture ensure the user of less fatigue than with conventional handles. Made in Germany.

Item	Order #	Description	Length	1+
K	46-1520	Chain Nose	4¾"	\$25.20
L	46-1521	Flat Nose	4¾"	\$21.80
M	46-1522	Round Nose	4¾"	\$21.80
N	46-1523	Flush Side Cutter	4¾"	\$24.00
P	46-1524	Flush End Cutter	4¾"	\$38.55
Q	46-1525	Flush Oblique Cutter	4¾"	\$38.55
R	46-1526	Bent Chain Nose	4¾"	\$22.70



K

L

M

N

P

Q

R



PLIERS

These pliers feature a comfortable rubber handle and a smooth operating box joint.

Item	Order #	Description	Length	1+
A	46-8000	Chain Nose	5 1/8"	\$9.65
B	46-8001	Flat Nose	5 1/8"	\$9.65
C	46-8002	Round Nose	5 1/8"	\$9.65
D	46-8003	Bent Nose	5"	\$9.65
E	46-8004	Half-Round	5 1/8"	\$10.30
F	46-8005	Round Concave	5 1/8"	\$10.30
G	46-8006	Ring Holding	5 3/16"	\$11.00
H	46-8007	Flat Half-Round	5 1/8"	\$9.65

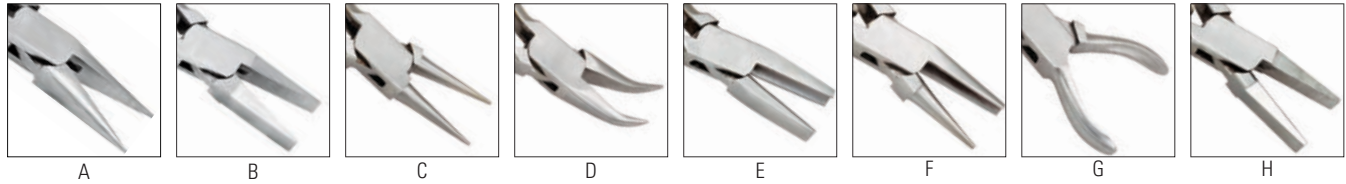

ECONOMY LAP JOINT PLIERS

Good quality carbon-steel work pliers have smooth jaws. With polished heads to prevent marking on soft metals and cushion grip handles.

Item	Order #	Description	Length	1+
J	46-0170	Flat Nose	4 1/2"	\$6.20
K	46-0180	Round Nose	4 1/2"	\$6.20
L	46-0175	Chain Nose	4 1/2"	\$5.30



SLIM-LINE PLIERS

High-quality, tool steel, box-joint construction. Plastic grips and leaf springs. Made in Germany.

Item	Order #	Description	Length	1+
M	46-0526	Diagonal Cutter	4 3/4"	\$24.90
N	46-0520	Flat Nose	4 3/4"	\$21.95
P	46-0522	Round Nose	4 3/4"	\$21.80
Q	46-0528	Oblique Flush Cutter	4 3/4"	\$28.55
R	46-0524	Chain Nose	4 3/4"	\$21.80
S	46-0530	Flush Cut End Cutter	4 3/4"	\$25.20

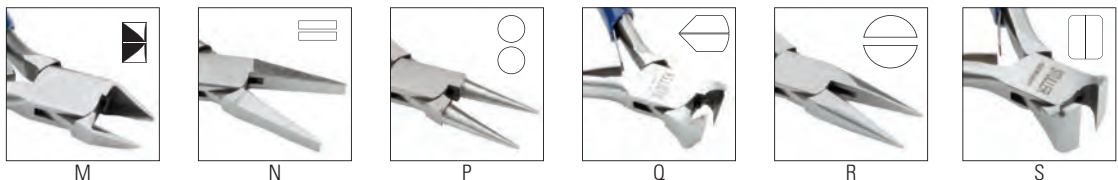

Pliers, Cutters, and Shears



PLIERS KIT

These pliers feature comfortable rubber handles and smooth operating box joint.

Order #	Description	12+	6+	1+
46-0539	Slimline Pliers Kit Set of 4	\$13.94	\$14.76	\$16.40



ECONOMY TOOL KIT

This economy tool kit with zip pouch comes complete with all the tools you need to begin beading. It features chain nose pliers, round nose pliers, wire cutters, tweezers, a bead scoop, snips, and six modular and stackable drawers, all zipped into a handy storage pouch. The complete kit is ready to travel and keeps tools neatly organized. Store various findings and beads in the drawers.

Order #	Description	12+	6+	1+
46-0516	7 Piece Repair Kit	\$13.09	\$13.86	\$15.40



MINI TOOL KIT

The perfect set of mini tools for quick repairs and for travel. Contains all the tools necessary for wire wrapping and other stringing functions. These mini tools are 3" long. Set is complete with chain nose pliers, round nose pliers, flat nose pliers, fiber tipped pliers, and a cutter, all zipped up into the blue pouch.

Order #	Description	12+	6+	1+
46-0515	5 Piece Repair Kit	\$11.22	\$11.88	\$13.20



MICRO MINI PLIERS

These pliers are a great choice for product assembly or bead stringing. To open split rings, insert the tooth onto the side of the ring and squeeze gently.

Item	Order #	Description	Length	12+	6+	1+
A	46-9003	Bent Flat Nose Pliers	5"	\$6.12	\$6.48	\$7.20
B	46-3070	Split Ring Pliers	5¼"	\$7.78	\$8.24	\$9.15
C	46-4006	Bead Knot Pliers	5"	\$8.80	\$9.32	\$10.35

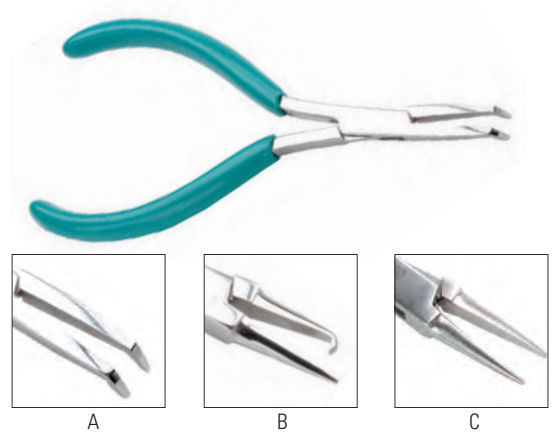

ROSARY PLIERS

Combination round nose pliers and side cutter all in one tool. Used for chain assembly. Loops and bends can be made easily. Wire can be cut without changing tools.

Order #	Description	Length	12+	6+	1+
46-0540	Rosary Pliers	5¼"	\$28.01	\$29.66	\$32.95

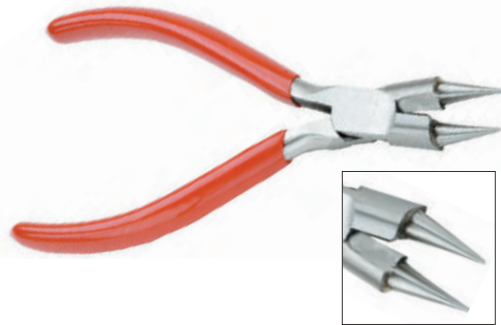

90° BENT NOSE PLIERS

Perfect for stone setting, especially for small prongs and tennis bracelets. The 90° angle makes precise work easier. Box-joint construction, cushion grips, and leaf spring.

Order #	Description	Length	12+	6+	1+
46-3085	90° Bent Nose Pliers	5"	\$11.14	\$11.79	\$13.10



ROUND NOSE PLIERS

The ultimate ultra-fine round nose has fine smooth jaws that allow the user to make the smallest loops with utmost accuracy every time. The tip diameter measures less than 1mm for the most delicate work. Smooth jaws are easy on the wire yet strong enough to hold without slipping. PVC comfort grip.

Order #	Description	Length	12+	6+	1+
46-0541	Ultra-Fine Tip Pliers	4½"	\$6.55	\$6.93	\$7.70

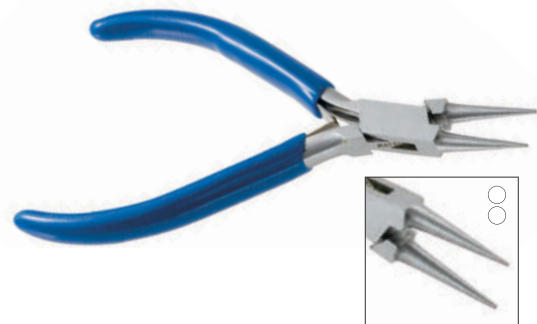

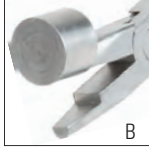
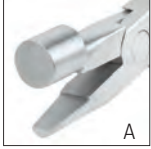

WRAP N TAP RING LOOPING PLIERS

The jeweler can wrap ring stock around the barrel-shaped jaw, then tap it slightly on a mandrel and instantly make a complete ring, half or quarter-shank for repair. Pliers are especially good for hollow rings and rings with a design on one side, because the lower jaw is covered with PVC tubing and cannot scratch or mark. You get a perfect circle time after time with stock up to 2mm thick. Made of stainless steel with PVC cushion grips.

Item	Order #	Description	Outside Diameter	Length	12+	6+	1+
A	46-4015	Ladies'	14 mm	6"	\$18.66	\$19.76	\$21.95
B	46-4016	Gents	16 mm	6"	\$18.66	\$19.76	\$21.95

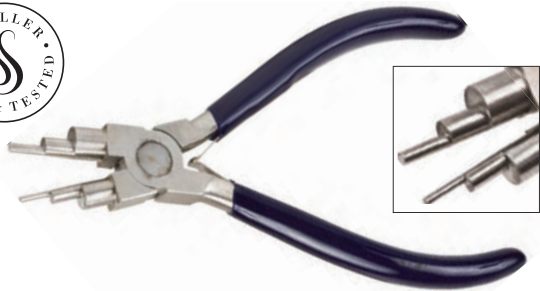

TRIPLE BAIL LOOPING PLIERS

Multi-size looping pliers can make a variety of loops from 2mm-9mm for a variety of combinations. Made of stainless steel with double-leaf spring.

Order #	Description	Length	12+	6+	1+
46-0406	Triple Bail Pliers	5 3/4"	\$15.90	\$16.83	\$18.70



WIRE LOOPING PLIERS

Stainless steel wire looping pliers. Also known as coupling pliers. Enables the user to bend wire easily. Three round jaws in one and box-jointed for durability. Finely polished. One round and one concave jaw.

Order #	Description	Length	12+	6+	1+
46-3080	Wire Looping Pliers	5 3/4"	\$11.56	\$12.24	\$13.60



MASTER COILER PLIERS

Makes loops and coils without marking precious wire. Most concave/convex pliers nick, but the new "Master Coiler" allows one to hold the wire with the flat jaw while rotating the round jaw to form the perfect loop. Comfort grips, rust-resistant, highly polished, stainless steel jaws, and a standard step jaw for consistent loops and coils.

Order #	Description	Length	12+	6+	1+
46-9005	Master Coiler Pliers	5 3/4"	\$11.22	\$11.88	\$13.20



WIRE-TWISTING PLIERS

Safely twists wire up to .06 gauge. Simple one-pull action and automatic return twists wire quickly into a strand that won't unravel. Hardened and tempered.

Order #	Description	Length	12+	6+	1+
46-9010	Wire-Twisting Pliers	9"	\$20.49	\$21.69	\$24.10



PARALLEL ACTION PLIERS

Heavy Flat Nose Pliers:

Has V-slot running the length of the serrated jaws for holding wire.

Combination Pliers:

Flat nose pliers with V-slot and serrated jaw combined with a wire cutter.

Chain Nose Pliers:

Smooth nose, non-serrated, tapered pliers for a variety of projects.



Item	Order #	Description	Length	12+	6+	1+
A	46-5060	Heavy Flat Nose Pliers	5½"	\$20.40	\$21.60	\$24.00
B	46-5140	Combination Pliers	5"	\$28.82	\$30.51	\$33.90
C	46-5160	Combination Pliers	5½"	\$30.01	31.77	35.30
D	46-5200	Chain Nose Pliers	5"	\$28.73	\$30.42	\$33.80

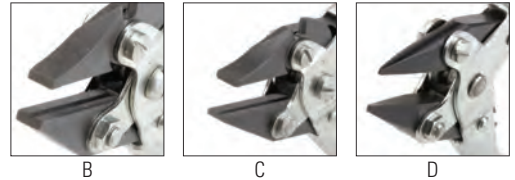

LIGHT FLAT NOSE PARALLEL PLIERS

Parallel action. A square, vise-like grip is provided by the jaws opening and closing parallel along entire length. Handles and jaws are nickel-plated.

Item	Order #	Description	Length	12+	6+	1+
E	46-5100	Serrated Jaws with V-Slot	5"	\$20.19	\$21.38	\$23.75
F	46-5120	Smooth Jaws	5"	\$22.14	\$23.45	\$26.05
G	46-2850	Half-Round Jaws	5"	\$54.19	\$57.38	\$63.75

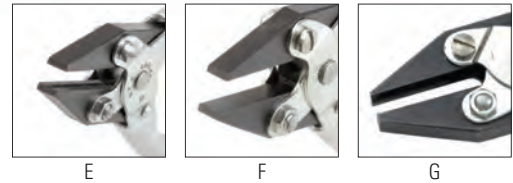

SWISS BENDING PLIERS

Bending pliers designed for bending flat and round stock, sheet metal, and wire into various shapes. Made of aircraft-quality aluminum. Bends up to 4mm round or flat stock and 15mm sheet width. Made in Switzerland.

Order #	Description	Length	12+	6+	1+
46-9006	Swiss Bending Pliers	7¾"	\$141.70	\$150.03	\$166.70



SUPERFIT™ PARALLEL RING-BENDING PLIERS

Uses parallel action to bend and hold rings without distorting shanks.

Order #	Description	Length	12+	6+	1+
46-0064	Ring Bending Pliers	5½"	\$51.55	\$54.59	\$60.65



Pliers, Cutters, and Shears

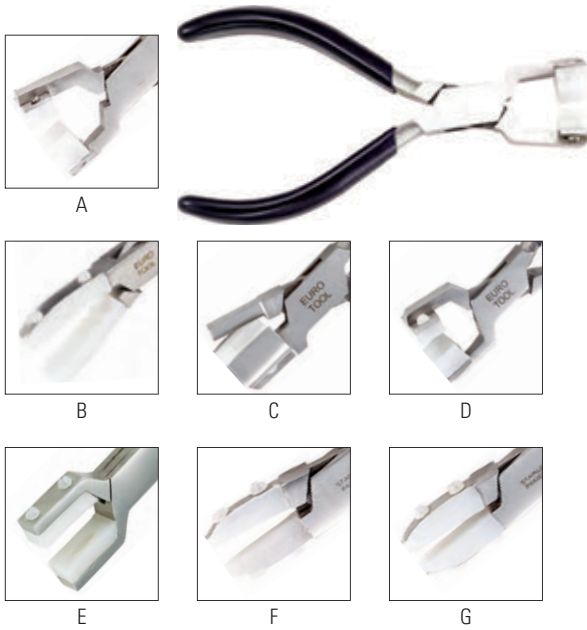

NYLON BENDING PLIERS

Nylon jaw pliers for bending or reshaping without scratching. Jaw is made of nylon and highly polished stainless steel.

Item	Order #	Description	Length	12+	6+	1+
A	46-2086	Bending	5¼"	\$19.42	\$20.57	\$22.85
	46-2087	Jaws Only (for 46-2086)		\$4.46	\$4.72	\$5.25
B	46-2092	Tube Holding	6½"	\$23.42	\$24.80	\$27.55
	46-2093	Jaws Only (for 46-2092)		\$4.68	\$4.95	\$5.50
C	46-2084	Ring Bending	5¼"	\$19.42	\$20.57	\$22.85
	46-2085	Jaws Only (for 46-2084)		\$4.46	\$4.72	\$5.25
D	46-2090	Bracelet Bending	5"	\$19.08	\$20.20	\$22.45
	46-2091	Jaws Only (for 46-2090)		\$4.46	\$4.72	\$5.25
E	46-2088	Ring Holding	5½"	\$19.42	\$20.57	\$22.85
	46-2089	Jaws Only (for 46-2088)		\$4.46	\$4.72	\$5.25
F	46-2080	Thin Nose	5¾"	\$12.67	\$13.41	\$14.90
	46-2081	Jaws Only (for 46-2080)		\$4.46	\$4.72	\$5.25
G	46-2082	Flat Nose	5¾"	\$12.67	\$13.41	\$14.90
	46-2083	Jaws Only (for 46-2082)		\$4.46	\$4.72	\$5.25

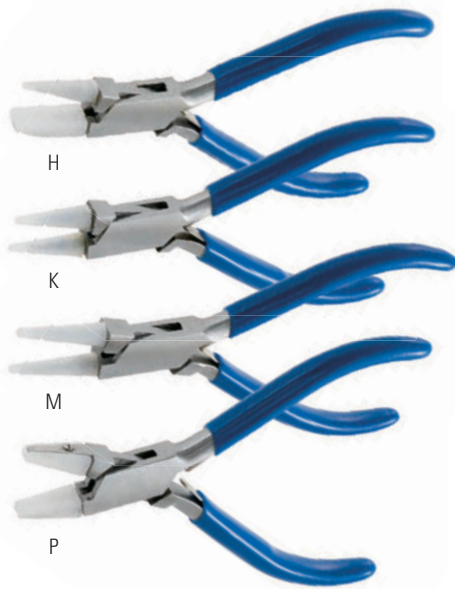

NYLON SPECIALITY FORMING PLIERS

The nylon jaw pliers are a necessity for the discerning jeweler. The quality nylon will not mar, scratch, bend, or twist. Be creative with these new designer specialty pliers. Stainless steel box joint with comfort PVC grip allows for long periods of use without hand fatigue. Replacement jaws are available.

Item	Order #	Description	Length	12+	6+	1+
H	46-0542	Round/Flat Nose	4½"	\$9.35	\$9.90	\$11.00
	46-0543	Jaws Only (for 46-0542)		\$1.40	\$1.49	\$1.65
K	46-0544	Small Round Nose	4½"	\$9.35	\$9.90	\$11.00
	46-0545	Jaws Only (for 46-0544)		\$1.40	\$1.49	\$1.65
M	46-0546	Large Round Nose	5½"	\$12.16	\$12.87	\$14.30
	46-0547	Jaws Only (for 46-0546)		\$1.40	\$1.49	\$1.65
P	46-0548	Tapered	4½"	\$9.35	\$9.90	\$11.00
	46-0549	Jaws Only (for 46-0548)		\$1.40	\$1.49	\$1.65

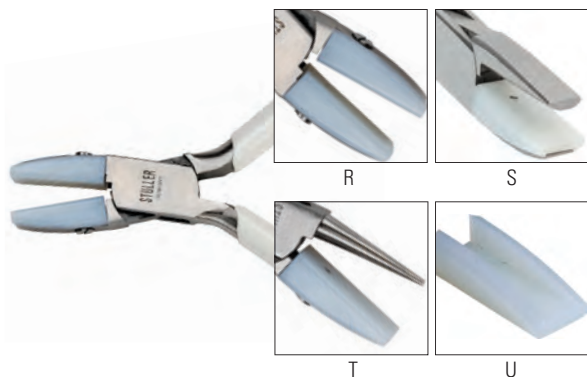
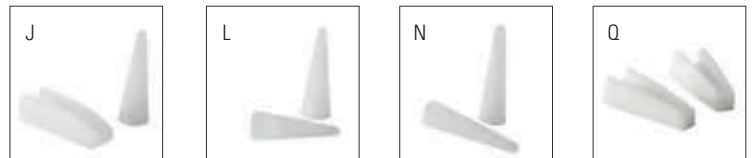

NYLON SPECIALITY FORMING PLIERS

High quality, stainless steel pliers have box joints and plastic comfort grips. These unique pliers have special nylon jaws to prevent marking or marring. Nylon can be filed and shaped for special jobs or applications. Replacement jaws are available. Made in Germany.

Item	Order #	Description	Length	12+	6+	1+
R	46-3000	2 Flat Nose	5½"	\$36.17	\$38.30	\$42.55
S	46-3002	Flat Nose/Half-Round Metal Nose	5½"	\$35.23	\$37.31	\$41.45
T	46-3004	Flat Nose/Round Metal Nose	5½"	\$35.22	\$37.30	\$41.44
U	46-3006	Jaw Insert Only	5½"	\$6.55	\$6.93	\$7.70

SOLDER-CUTTER PLIERS WITH HOLE

Cuts sheet solder in 1/16" squares or wire solder up to 18 gauge in 1/16" lengths for easy handling and melting. Made of stainless steel with box-joint construction.

Order #	Description	Length	12+	6+	1+
46-4035	Solder-Cutter Pliers	5 1/2"	\$17.43	\$18.45	\$20.50



CONCAVE RING BENDING PLIERS

These unique box-joint pliers are made to round any size due to their exclusive shape. The lower (concave) jaw goes from 10.5mm at the tip to 17mm at the base.

Order #	Description	Length	12+	6+	1+
46-2900	Concave Ring Bending Pliers	6 1/2"	\$44.88	\$47.52	\$52.80



LARGE RING BENDING PLIERS

This ring bending plier has a box-joint with cushion grip handles for maximum leverage. Jaws are concave/convex for shaping shanks, with the convex being slightly thinner than the concave jaw. Made in Germany.

Order #	Description	Length	12+	6+	1+
46-2905	Large Ring Bending Pliers	6 1/2"	\$35.32	\$37.40	\$41.55



BENDING PLIERS WITH TEXTURED GRIPS

This new line of bending pliers offers the best quality/price combination anywhere. Stainless steel, boxed-joint construction, and blue textured PVC handles assure years of satisfaction. Working surfaces feature rounded corners and are highly polished to prevent scratching precious metals. You will not find better bending pliers.

Item	Order #	Description	Length	12+	6+	1+
A	46-0063	Concave/Convex Bending	5"	\$16.83	\$17.82	\$19.80
B	46-0066	Round Nose/Flat Nose Looping	5"	\$13.01	\$13.77	\$15.30
C	46-0067	Flat Nose/Half-Round Bending	5"	\$13.01	\$13.77	\$15.30
D	46-0068	Round Nose/Concave Nose Bending	5"	\$13.01	\$13.77	\$15.30

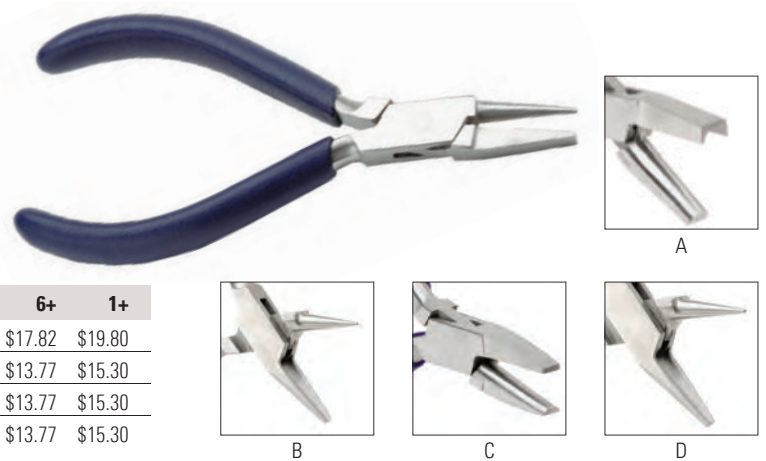

HEAVY DUTY RING BENDING PLIERS

Extra-heavy pliers used for bending metal at right angles, closing bows, and bending ring shanks.

Order #	Description	Length	12+	6+	1+
46-0062	Ring-Bending Pliers	6 1/2"	\$13.22	\$14.00	\$15.55





THE #1 CONNER BEAD SETTING PLIERS

These #1 pliers will replace the common beading tool on a great many jobs, making them considerably easier. No longer will you need to hold items in the ring clamp and on the bench pin, or fill a fragile item with shellac. This tool will give you the support from the underside you need to do common, everyday tightening and setting stones, plus many applications you'll discover as you use this great tool!

- Used like a beading tool 50% of the time – faster and easier
- Supports from underneath – no shellac needed
- Can be used to hold stones (culet to table) while being heat-set into wax models

Order #	Description	12+	6+	1+
46-4009	#1 Beading Setting Pliers	\$14.03	\$14.85	\$16.50



THE #2 CONNER BEAD SETTING PLIERS

These #2 pliers are especially helpful to set or tighten side stones on a basket setting as well as on other mounting types. One side of the pliers has a slot for the wire under the stone and the other side has a beading tool cup on it. Also great for setting earrings! Simply slide the post through the slotted side and bring the beading tool down on the prong, making this type of work much quicker and easier.

- Perfect for setting and tightening accent stones surrounding center stones
- Great for earrings, with or without under bezel wires
- Size of beading cup can be made smaller or larger

Order #	Description	12+	6+	1+
46-4011	#2 Beading Setting Pliers	\$11.99	\$12.69	\$14.10



SETTING PLIERS

Ideal for opening, closing, and tightening prongs. Slim nose allows for reaching small areas.

Order #	Description	12+	6+	1+
46-0058	Stone Setting Pliers	\$17.43	\$18.45	\$20.50

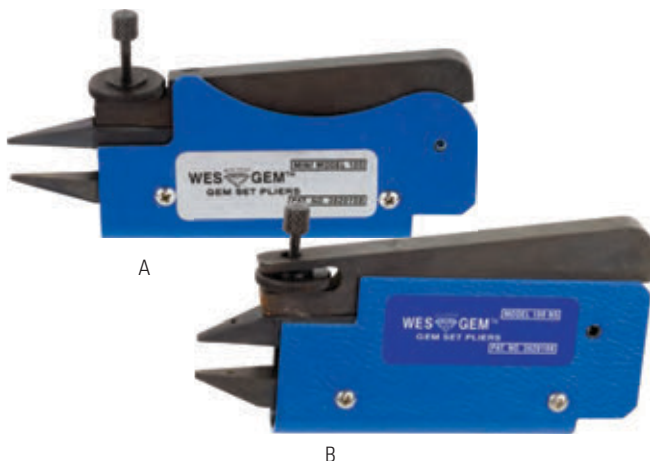

GEM SET PLIERS

Simplify stone setting. Lever action improves control and mechanical advantage. Adjustable parallel action to avoid over-tightening stones. Sold in two styles. Made in the USA.

- Heavy-Duty— with slightly shorter, less tapered jaws
- Standard— jaws taper to a finer tip allowing easy access to small stones

Item	Order #	Description	12+	6+	1+
A	46-3482	Standard Jaw	\$33.58	\$35.55	\$39.50
B	46-3483	Heavy-Duty Jaw	\$33.62	\$35.60	\$39.55

Meet the **TOOLS TECH TEAM**

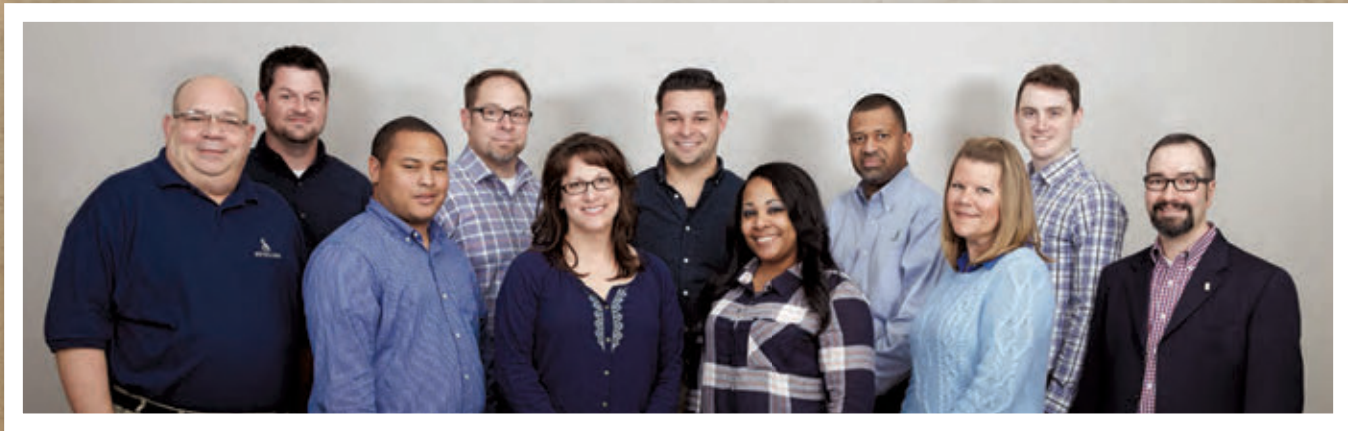

You've spoken to them numerous times — like the time they talked you through that tough prong repair just before Christmas or that time they called to say hello on your store's anniversary. It's time to put a face with that name.

Combined, the Tools Tech Team holds more than 80 years of experience in the industry, including but not limited to the following areas of expertise:

- Polishing
- Sales
- Prepping
- Tumbling
- Findings
- Assembly
- Plating
- Cleaning
- Laser Training
- Quality Assurance and Improvement
- Research and Development

Visit BenchJeweler.com to post a forum question or live chat with a member of the team.

Or call anytime at 800-877-7777, extension 4300.

BenchJEWELER.COM

powered by  STULLER



STONE SETTING PLIERS

Used to tighten loose prongs or for initial setting of stones. Made in Germany.

Order #	Description	Length	12+	6+	1+
46-3480	Setting Pliers	5"	\$37.27	\$39.47	\$43.85



PERFECT SET PLIERS

Designed specifically for closing prongs on tennis bracelets quickly, efficiently, and properly. The angled jaw allows the user to properly bend the prong, making every setting job much easier than with conventional pliers. "Perfect Set" pliers also work great for setting stones on pins, cuff links, coin rings, and lightweight or promotional jewelry. Invented by a jeweler.

Order #	Description	Length	12+	6+	1+
46-2430	Perfect Set Pliers	5½"	\$11.65	\$12.33	\$13.70

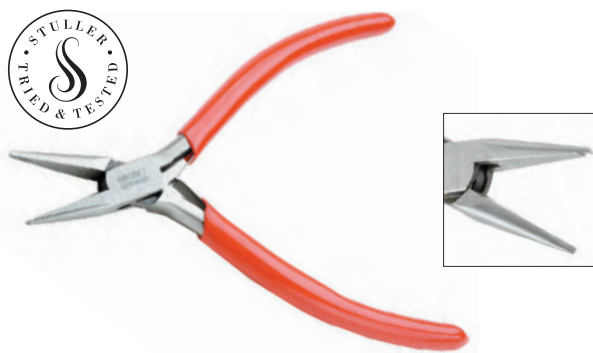

PRONG OPENING PLIERS

Ideal for opening prongs without fracturing stones. The top jaw is a claw that grips the prong cleanly, and the lower jaw is grooved to hold the prong. No pressure is applied on the top of the stone. Made in Germany.

Order #	Description	Length	12+	6+	1+
46-4000	Prong Opening Pliers	4½"	\$31.45	\$33.30	\$37.00



PRONG OPENING PLIERS

These pliers feature a thinner claw to get behind prongs. The angle and length to bottom jaw provides precise leverage to minimize stone damage. Lower jaw is grooved to prevent sideways slipping. Made in Germany.

Order #	Description	Length	12+	6+	1+
46-3990	Prong Opening Pliers	5¼"	\$35.32	\$37.40	\$41.55

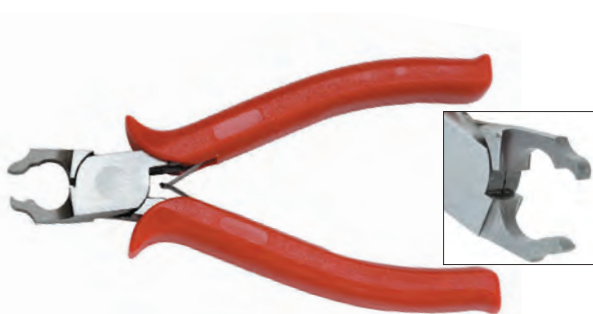

PRONG LIFTING PLIERS

Prong lifting pliers designed for lifting prongs to remove set stones. The lower jaw supports the base of the prong while the knife-sharp upper jaw lifts the prong. Jaw length 0.125" (3mm). Made in Germany.

Order #	Description	Length	12+	6+	1+
46-4004	Prong Lifting Pliers	5¼"	\$41.18	\$43.61	\$48.45

STONE REMOVAL PLIERS

Box joint allows perfect alignment of jaws. Cushion-grip handles for comfort. Removes stones easily, which prevents damage. Can be used on all prong settings, clusters, channels, fishtails, and baguettes. Tips are thin and narrow to fit into tight recessed areas and very small settings.

Order #	Description	Length	12+	6+	1+
46-0059	Stone Removal Pliers	6½"	\$10.71	\$11.34	\$12.60

**BOW-OPENING PLIERS**

Heavy-duty, special-joint pliers. Jaws are kept closed by spring in handle. When handles are compressed, jaws open. Used to open bows, links, and jump rings.

Order #	Description	Length	12+	6+	1+
46-3030	Bow-Opening Pliers	5¾"	\$46.03	\$48.74	\$54.15

**BOW-CLOSING PLIERS**

Heavy-duty pliers used for closing small bows and loops. Strong and rugged enough to be used to bend ring shanks.

Order #	Description	Length	12+	6+	1+
46-3060	Bow-Closing Pliers	6½"	\$42.80	\$45.32	\$50.35

**LOOP CLOSING PLIERS**

Jaws are shaped and smoothly finished to close loops, jump rings, bracelet links, bows, etc., without distorting or scratching. With box joint and cushion grip handles

Order #	Description	Length	12+	6+	1+
46-0057	Loop Closing Pliers	4½"	\$11.65	\$12.33	\$13.70

**RING HOLDING PLIERS**

Large, grooved, semi-circular jaws hold rings during filing or polishing. With box joint.

Order #	Description	Length	12+	6+	1+
46-0380	Ring Holding Pliers	5¼"	\$12.75	\$13.50	\$15.00

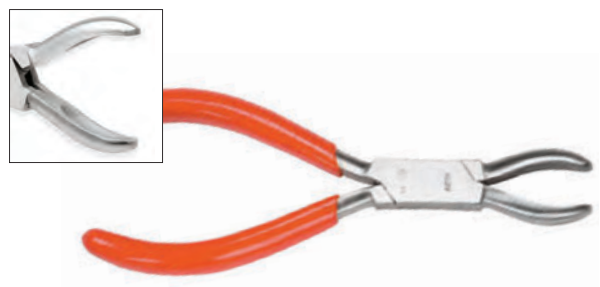



HOLE PUNCH PLIERS

This handy tool allows you to punch additional holes to size leather or plastic bands. Allows a 2mm punch with precise clearance for clean cut. Made of fine steel for long life. Euro-grip handles for comfort.

Order #	Description	Length	12+	6+	1+
46-3050	Hole Punch Pliers	5 3/4"	\$9.18	\$9.72	\$10.80



PUNCH PLIERS

Powerful, lightweight hand tool for punching holes in all types of metals. Punch accurate, precision round holes in steel, aluminum, brass, copper, plastic, etc., with one hand. Great for use where electricity or power is not available. Comes with a side gauge for depth adjustment. It is perfectly balanced with curved handles for a natural grip. Will pierce up to 14 gauge mild steel. Comes with seven popular sizes: 3/32", 1/8", 5/32", 3/16", 7/32", 1/4", and 9/32".

Order #	Description	L x H	12+	6+	1+
46-0000	Round Power Punch	8 3/4" x 3 7/8"	\$35.32	\$37.40	\$41.55



REVOLVING PUNCH PLIERS

A convenient, spring-tension, self-opening tool for punching round holes in leather, plastic, rubber, and similar materials. Made of plated steel with six tapered and hollow, hardened-steel punches. Punch sizes: 2.0, 2.5, 3.0, 3.5, 4.0, and 4.5mm.

Order #	Description	Length	12+	6+	1+
46-3057	Revolving Punch Pliers	9"	\$11.05	\$11.70	\$13.00



METAL HOLE PUNCH PLIERS

Will punch copper or silver as thick as 18 gauge. With ergonomic handles and tempered replaceable pin, these pliers will save you time and money. The pliers are made of thick carbon steel and come with an extra 1/8" replaceable pin.

Item	Order #	Description	Length	12+	6+	1+
A	46-0404	Metal Hole Punch Pliers	5 1/4"	\$14.03	\$14.85	\$16.50
B	46-0405	Replacement Pins	1 1/8"	\$6.55	\$6.93	\$7.70



SKILL ELECTRIC CUTTER

Remove rings almost instantly with this high-quality, powerful, cordless electric ring cutter with recharging unit. It will cut the strongest alloys in less than 10 seconds without heat or discomfort. The blade guard slips under the ring and completely protects the hand and fingers. Sterilization of the chrome blade assembly can be easily done. Three year warranty on cutting unit—excluding blade. Comes with 1 gasket. Also takes 4 AA batteries. US PAT 4864730.

Item	Order #	Description	12+	6+	1+
A	48-1803	Electric Ring Cutter			\$200.10
B	48-1804	Replacement Blades (pack of 2)	\$49.56	\$52.47	\$58.30



STULLER RING CRACKER

Allows you to crack any ceramic or tungsten ring with no pain to the wearer. Very easy to use anybody can assist with the removal of these alternative metals. The kit comes with a Ring Cracker, two pairs of safety glasses and instructions. Only removes tungsten and ceramic rings.

Order #	Description	1+
58-2440	Ring Cracker	\$93.70

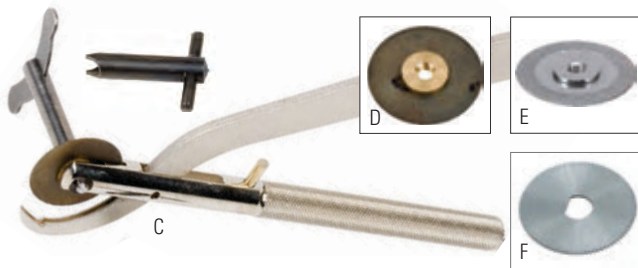

RING CUTTER

Saws rings while on or off the finger. The lower jaw of the cutter slides between the ring and hand. The circular saw can be turned by the handle to cut through the ring. Handle is knurled and non-slip. Nickel-plated, except for saw. Will not cut titanium. Comes with attachment to hook to electric cutter.

Item	Order #	Description	Length	12+	6+	1+
C	48-1800	Ring Cutter with 1 Saw	4½"	\$44.92	\$47.57	\$52.85
D	48-1801	Replacement Saw		\$11.39	\$12.06	\$13.40
E	48-1802	Replacement Saw (Diamond)		\$37.44	\$39.65	\$44.05
F	48-1806	Beaver Blade		\$20.53	\$21.74	\$24.15



PRECISION SCISSORS

Used for beading and other delicate work. Handles are large and made of black ABS. Small, pointed blades are made of high quality stainless steel. Blades are held together with a stainless steel high-impact rivet and nylon washer, which provide smooth cutting and extended life.

Order #	Length	Blade Length	12+	6+	1+
53-6200	4"	1¼"	\$11.05	\$11.70	\$13.00



MICRO-SNIP BEADING SHEAR

Ideal for bead string and thread snipping.

Order #	Length	12+	6+	1+
53-2800	3½"	\$3.74	\$3.96	\$4.40



CROWN SCISSORS

Made of forged steel, expertly tempered and hardened. Hand-ground edges retain a keen cut after long use. Straight blades are used to cut hard wire or sheet up to B&S #27 and soft wire up to B&S #16. Blades are short and stubby.

Order #	Blade Length	Blade Width	12+	6+	1+
53-8070	¾"	¼"	\$17.68	\$18.72	\$20.80



6" SIDE CUTTER

These cutters are designed for larger jobs where strength and leverage are important. They are 6" -150mm- sidecutters with cushioned grips, gentle coil-return spring and semi-flush jaws.

Order #	Description	12+	6+	1+
46-0070	Side Cutter	\$4.21	\$4.46	\$4.95



6" SPRUCE CUTTER FOR PLASTIC

These cutters are totally flush and were manufactured to cut plastic sprues. They can also flush cut very small and softer wires. PVC grips and a coil spring return for ease of use. Length 6" -150mm.

Order #	Description	12+	6+	1+
46-0071	Spruce Cutter	\$8.46	\$8.96	\$9.95

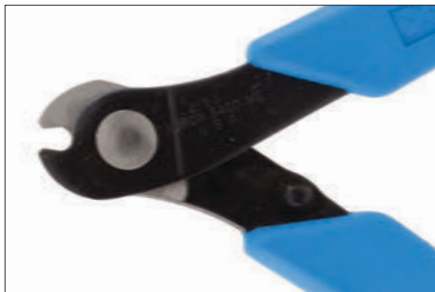

XURON® WIRE SHEAR

This HWAC plier is rated for hard wire, music wire, and throttle cable. This is ideal for the craftsperson who needs to cut a variety of metals.

Order #	Description	Length	12+	6+	1+
46-0504	Perfect Set Pliers	5½"	\$14.96	\$15.84	\$17.60



XURON® HIGH DURABILITY SCISSORS

Features precision ground high carbon steel cutting edges. Excellent for cutting solder and sheets of light gauge metal up to 0.030" (0.8mm). For line and all bead cords, these pliers have serrations on one edge to keep material secure while cutting.

Order #	Description	Length	12+	6+	1+
46-0513	High Durability Scissors	6"	\$18.70	\$19.80	\$22.00



XURON® HIGH PRECISION SCISSORS

Ultra-precise, the Xuron™ scissor cuts fine or delicate items with a clean, square edge cut. Cushion grips and return spring provide increased comfort and precision. Rated for cutting soft metals up to 0.005". Including materials such as silk, embroidery, floss, or thin mylars.

Order #	Length	Jaw Length	12+	6+	1+
46-0508	5"	½"	\$14.96	\$15.84	\$17.60



XURON® MICRO SHEAR®

A superior tool offering both precision cutting and exceptional life. The Xuron™ Micro Shear™ is ideal for cutting soft metals and solders. Cutting edges are heat treated to a hard 57-59 RC.

Order #	Length	Jaw Length	12+	6+	1+
46-0509	6"	1½"	\$18.70	\$19.80	\$22.00

MICRO SHEAR® FLUSH CUTTERS

Micro Shear is a registered trademark of Xuron Corporation, which is applied only to products that utilize blade by-pass shear-cutting action. This patented design requires about half the effort to cut a wire as compared to conventional compression-type wire cutters. All primary cutting surfaces are generated on high-precision, three microprocessor-controlled, self-diagnostic grinding equipment. This ensures that the grinding on every blade is as identical as computer controlled tolerances allow.

Features include:

- Ergonomic shape
- Xuro-rubber™ grips
- Black finish to eliminate glare
- Light Touch™ return spring

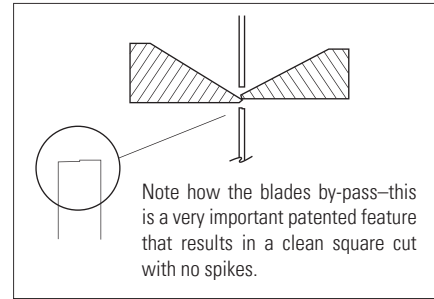

MICRO FLUSH CUTTER DELUXE

Made of hardened tool steel and induction-hardened jaws, the cutting edge is relieved for a clean cut with a fine point for tight work. With comfort grips and a steel spring, this cutter is perfect for those smaller jobs, and reasonably priced. Excellent for small prongs, chain, and other items.

Order #	Description	Length	12+	6+	1+
46-4010	Flush Cutter	4¾"	\$9.95	\$10.53	\$11.70



MAXI SHEAR® FLUSH CUTTERS

Tough 6" flush cutters featuring a patented Micro Shear® cutting action. For cutting soft metals and wire up to 14 gauge (1.6mm) thick. Leaves clean square cuts. Ergonomic shape and non-slip Xuro-Rubber™ grips. Two styles - Standard flush cutter and flush cutter with lead retainer that holds small pieces of wire as it is cut. Overall length 5.82". Jaw length 0.47".

Item	Order #	Description	Length	12+	6+	1+
A	46-0501	Flush Cutter	5½"	\$14.37	\$15.21	\$16.90
B	46-0507	Flush Cutter w/ Retainer	5½"	\$15.32	\$16.22	\$18.02



MICRO SHEAR® FLUSH CUTTERS

This pair flush cuts soft wire up to 20 gauge (0.8mm) thick.

Order #	Length	Blade Length	12+	6+	1+
46-0500	5"	½"	\$8.20	\$8.69	\$9.65



MICRO SHEAR® FLUSH CUTTERS

This tapered head design allows positioning, even on finepitch leads. Tapered head flush cuts soft wire up to 14 gauge (1.6mm) thick.

Order #	Length	Blade Length	12+	6+	1+
46-0503	5"	⅓"	\$18.70	\$19.80	\$22.00



LIGHTWEIGHT METAL SNIPS

Used for cutting templates and patterns from metal sheet up to B&S #20, medium hard metal to B&S #16, and soft metal. Overall length 7" (178mm) with a 1½" (38mm) cutting length. Made in Germany.

Order #	Description	12+	6+	1+
46-5005	Straight Snips	\$14.01	\$14.83	\$16.48





LINDSTROM® MULTIPURPOSE SHEAR

Ergonomic, cushion grip handles. Blades with a 57-59 Rockwell Hardness for long life. These Lindstrom® shears cut easily through 28 gauge silver stock.

Order #	Length	12+	6+	1+
46-8163	5¾"	\$24.06	\$25.47	\$28.30



JEWELER'S SHEARS

Excellent for clipping chains, solders, and thin metals. The tempered steel, polished jaws provide an easy cut. Overall length 7" (178mm).

Item	Order #	Description	12+	6+	1+
A	46-5015	Straight Shear	\$14.96	\$15.84	\$17.60
B	46-5016	Straight Shear w/ Spring	\$22.36	\$23.67	\$26.30



LIGHTWEIGHT METAL SNIPS

Used for cutting templates and patterns from metal sheet up to B&S #20, medium hard metal to B&S #16, and soft metal. Overall length 7" (178mm) with a 1½" (38mm) cutting length. Made in Germany.

Item	Order #	Description	12+	6+	1+
C	46-5005	Straight Snips	\$14.01	\$14.83	\$16.48
D	53-8030	Curve Snips	\$16.79	\$17.77	\$19.75



JEWELER'S SNIPS

Used for cutting 24 gauge or thinner metals. Handles are coated with PVC.

Order #	Length	Blade Length	12+	6+	1+
46-5000	7"	1½"	\$14.01	\$14.83	\$16.48



HEAVY DUTY CHAINMAKER SHEARS

These are chainmaker's shears that contain precision, fine blades and blue handles. Made in Germany.

Order #	Length	Blade Length	12+	6+	1+
46-5020	7"	1½"	\$14.03	\$14.85	\$16.50

ULTRA FLUSH CUTTER

Italian-made cutter has a newly added safety clip to keep wire or other materials from flying when cut. With new ergonomic handle to lessen fatigue.

Order #	Description	Length	12+	6+	1+
46-4029	Flush Cutter	5½"	\$22.95	\$24.30	\$27.00



SEMI-FLUSH SIDE CUTTER

This new cutter made in Europe offers strength in a precision side cutter at an affordable price. Smooth spring return.

Order #	Description	Length	12+	6+	1+
46-4028	Semi-Flush Side Cutter	5"	\$22.48	\$23.81	\$26.45



C. H. P. MILANO ITALIAN FLUSH CUTTER

Made of high grade tool steel, this Italian cutter is perfect for lighter jobs where a flush cut is essential. This "shear action" cutter, made in Italy, features a blackened non-glare head, return spring, and high friction ergonomic grips. Maximum cut is 16 gauge 1.5mm copper wire.

Order #	Description	Length	12+	6+	1+
46-4002	Flush Cutter	5½"	\$9.35	\$9.90	\$11.00



POWER MAX™ CUTTERS

Ergonomic, compound cutter. Jaws are made of induction-hardened, high-grade steel and feature a semi-flush bevel for close work. Its ergonomically shaped handles prevent fatigue and injury.

Item	Order #	Description	Length	12+	6+	1+
A	46-4020	Cutter	6½"	\$34.21	\$36.23	\$40.25
B	46-4025	Full Flush Cutter	6½"	\$34.42	\$36.45	\$40.50



FULL FLUSH CUTTER

These cutters are specifically designed for multi-strand beading wire and full-flush with jaws induction hardened to 60-62 Rockwell. Used properly, this degree of hardness assures a clean cut, time after time. Cutting edges are precisely aligned and the black oxide non-glare head has a "relieved" design for reaching into tight areas. This quality German cutter also features double-leaf spring and yellow PVC handles. Use on flexible beading wire and soft wire only.

Item	Order #	Description	Length	12+	6+	1+
C	46-4013	Cutter	4½"	\$21.25	\$22.50	\$25.00
D	46-4014	Pointed Jaw Cutter	4½"	\$26.35	\$27.90	\$31.00

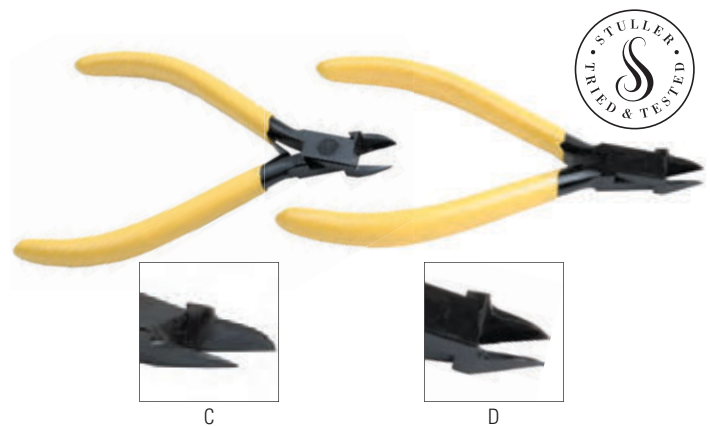



COMPOUND CUTTER

Heavy-duty diagonal cutter with compound leverage for cutting sprues with minimal effort. Made in Germany.

Order #	Length	Cutting Capacity	12+	6+	1+
53-9326	7½"	⅛"	\$36.68	\$38.84	\$43.15



NYLON SPECIALITY FORMING PLIERS

High quality, stainless steel pliers have box joints and plastic comfort grips. These unique pliers have special nylon jaws to prevent marking or marring. Nylon can be filed and shaped for special jobs or applications. Replacement jaws are available. Made in Germany.

Order #	Description	Length	12+	6+	1+
46-3000	2 Flat Nose	5½"	\$36.17	\$38.30	\$42.55



TRX 8180 LINDSTROM® CUTTER

Use on copper wire and hard wire applications. Handles solid copper wire and hard steel wire from 24 gauge -0.5 mm/0.02 inch- up to 9 gauge -2.75 mm/0.11 inch. This powerhouse cutter utilizes the new progressive cut beveled edges- suited for soft wire at the tip and hard wire closer to the jaw — for versatile operation. Micro-bevel cutting edges hardened to 63-65 for durable performance.

Order #	Length	12+	6+	1+
46-8164	8"	\$55.80	\$59.09	\$65.65



BERGEON HEAVY-DUTY SPRUE CUTTER

These top-quality cutters help reduce hand fatigue from constant usage by using a special linkage that multiplies your hand pressure many times. Extra-long handles provide additional leverage to help make cutting easier. Cuts sprues up to ⅛" (3mm) thick. Jaws are ⅞" (22mm) long and pointed for easier access to tight areas. Made in Switzerland.

Order #	Description	12+	6+	1+
64-6496	Sprue Cutter	\$124.61	\$131.94	\$146.60

SPRUE CUTTER DELUXE

Features compound construction with hardened, tool-steel jaws and a chrome-vanadium steel. Cuts soft wire up to 1/8" (3mm) and hard wire up to 0.039" (1mm). Weighs 12½ oz.

Order #	Length	12+	6+	1+
46-4030	9½"	\$78.46	\$83.07	\$92.30

**PARALLEL-ACTION DIAGONAL CUTTERS**

Jaws open and close parallel along entire length, providing firm, vise-like grip. Spring-action handle.

Order #	Length	Jaw Capacity	12+	6+	1+
46-5320	5½"	¼"	\$34.60	\$36.63	\$40.70

**GUILLOTINE SHEAR**

Superior cutting, but small enough to fit right on your bench. The maximum size cut is 4" W. We recommend a maximum thickness of 18 gauge for gold, silver, and copper only. Never use on stainless steel or heat treated or hardened metals. Miter table cuts 15°, 30° and 45° angles. The maximum cut width on angles is approximately 2".

Order #	Description	W × L	1+
28-2041	4 in. Shear	6¼" × 4"	\$321.40





QUATRO STAND-UP POLISHING UNIT

- Most efficient polishing station on the market
- True HEPA Filter, ensures 99.97% efficiency on the capture of precious metal particles
- 2 workstations with 2 SEPARATE collection bags, allowing for the separation of precious metals (platinum dust captured in one ClearView filter bag & gold dust captured in the other)
- CoolBlue motor supplied is 1/2 hp, 2-speed
- Middle drawer provides for extra storage (additional drawers available)
- Quiet yet powerful
- ClearView Hoods provide for a dust-free work environment
- Continuous duty motor for long-term performance

Order #	Description	W x H x D	CFM	1+
47-4221	Single Motor Unit	39" x 53" x 19"	1200 CFM	\$2,570.00

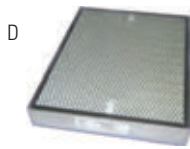

QUATRO REPLACEMENT PARTS

Item	Order #	Description	12+	6+	1+	
A	47-4108	Quatro Light Fixture	\$84.15	\$89.10	\$99.00	
	47-4217	Bulbs (Pack of 2)	\$22.10	\$23.40	\$26.00	
B	47-4213	Pre-Filter (Pack of 20)	\$46.00	\$48.00	\$50.00	
	47-4214	Pre-Filter (Pack of 500)	\$121.44	\$126.72	\$132.00	
C	47-4215	Filter Bags (Pack of 6)	\$61.00	\$63.65	\$66.30	
D	47-4216	HEPA Filter (Each)	\$126.68	\$132.19	\$137.70	
E	47-4752	Replacement Flaps (2 Pair)	\$24.61	\$26.06	\$28.95	
F	47-4033	On/Off Remote	\$40.80	\$43.20	\$48.00	
	47-2722	Right Spindle	5" Length	\$9.06	\$9.46	\$9.85
	47-2723	Left Spindle	5" Length	\$9.06	\$9.46	\$9.85

G



GOLDMAT

Sticky surface captures and holds on to gold and precious metals. Each mat contains 30 sheets.

Item	Order #	Description	W x L	12+	6+	1+
G	47-4106	Goldmat	24" x 36"	\$46.84	\$49.59	\$55.10
	47-4111	Goldmat	24" x 46"	\$54.66	\$57.87	\$64.30

QUATRO STAND-UP DOUBLE STATION POLISHING UNIT

- Most efficient polishing station on the market
- True HEPA Filter, ensures 99.97% efficiency on the capture of precious metal particles
- 2 workstations with 2 SEPARATE collection bags, allowing for the separation of precious metals (platinum dust captured in one ClearView filter bag & gold dust captured in the other)
- CoolBlue motor supplied is 1/2 hp, 2-speed
- Middle drawer provides for extra storage (additional drawers available)
- Quiet yet powerful
- ClearView Hoods provide for a dust-free work environment
- Lapper Containment Hood (with LED) captures at lapper source
- Continuous duty motor for long-term performance

Order #	Description	W x H x D	CFM	1+
47-4222	Double Station	45" x 59" x 19"	1200 CFM	\$2,999.00



QUATRO POLISH AND LAPPING UNIT

Premium Polishing-Grinding Recovery System

- Most efficient polishing station on the market
- True HEPA Filter, ensures 99.97% efficiency on the capture of precious metal particles
- 2 workstations with 2 SEPARATE collection bags, allowing for the separation of precious metals (platinum dust captured in one ClearView filter bag & gold dust captured in the other)
- CoolBlue motor supplied is 1/2 hp, 2-speed
- Middle drawer provides for extra storage (additional drawers available)
- Quiet yet powerful
- ClearView Hoods provide for a dust-free work environment
- Lapper Containment Hood (with LED) captures at lapper source
- Continuous duty motor for long-term performance
- One Lapper hood *Lapper sold separately

Order #	W x H x D	CFM	1+
47-4223	45" x 59" x 19"	1200 CFM	\$2,784.00



JUNIOR POLISHING UNIT

- Design ensures that your shop is clean (model c/w ClearView)
- Capture your gold inside filter bag, then send it for refining
- HEPA filter guarantees clean environment and ensures that air leaving the unit is absolutely clean
- ClearView enclosure contains all precious metals
- Maximum free air 600 CFM, 2 speed motor 1/4 hp.
- Light bulb included

Order #	Description	W x L x H	1+
47-4999	Deluxe Polisher	24" x 20" x 50"	\$1,595.00

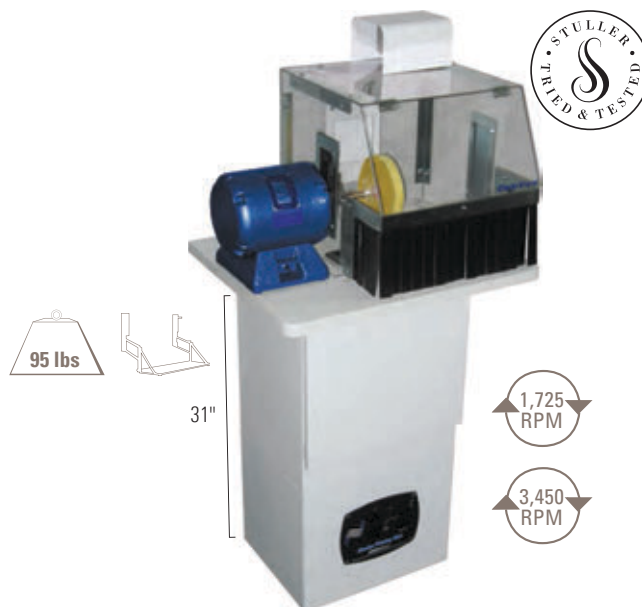



CUSTOMIZE YOUR OWN POLISHING AND GRINDING STATIONS

1 SELECT YOUR DUST COLLECTOR

QUATRO DUST COLLECTOR
Excellent for grinding, polishing, waxing, smoke, odors, and fumes. Also used for soldering smoke odors and fumes, rhodium odors, and mixing investments.



Item	Order #	Description	W x H x D	1+
A	47-4063	Collect All	17" x 31" x 14"	\$1,495.00
	47-4245	PG1 (1 user)	22" x 29½" x 14"	\$1,195.00
	47-4245	PG2 (1-2 users)	22" x 29½" x 14"	\$1,375.00

VELOCITY X-SERIES DUST COLLECTOR
Includes four pre-filters and six feet of heavy-duty hose per port.

Item	Order #	Description	W x L x H	Airflow	1+
B	47-4040	Single-Port	16" x 14" x 25"	175 CFM	\$950.00
C	47-4043	Double-Port	17" x 14" x 25"	360 CFM	\$1,199.00
D	47-4046	Four-Port	23" x 18" x 25½"	580 CFM	\$1,495.00

2 SELECT YOUR POLISHING MOTOR

QUATRO COOL BLUE MOTOR
Filter keeps dirt out, motor runs longer, cleaner and cool. Less heat = longer life. All motors are two-speed and accommodates a ½" straight spindle.

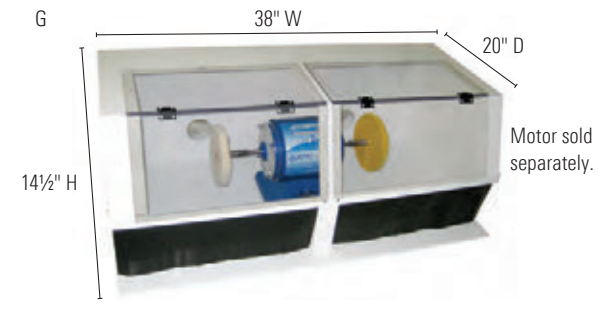

Item	Order #	Description	W x L x H	1+
E	47-3970	½ hp Single Shaft	8½" x 13½" x 9¾"	\$339.00
F	47-3971	½ hp Double Shaft	8½" x 17½" x 9¾"	\$369.95
	47-3972	¾ hp Single Shaft	8½" x 13½" x 9¾"	\$349.00
	47-3973	¾ hp Double Shaft	8½" x 17½" x 9¾"	\$389.00
	47-3974	Filter w/Support Kit	6"	\$25.45
	47-3975	Filter (6-Piece)	6"	\$29.00

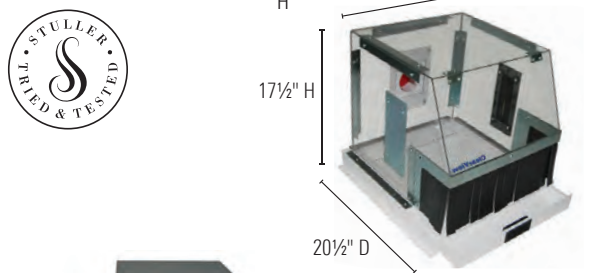

3 SELECT YOUR CAPTURE ACCESSORIES

QUATRO POLISHING HOOD

Item	Order #	Description	12+	6+	1+
G	47-4209	Double Enclosed ClearView Hood			\$950.00
H	47-5002	ClearView Hood w/Drawer	\$254.15	\$269.10	\$299.00
	47-4753	ClearView Hood	\$245.65	\$260.10	\$289.00
J	47-4109	Illumination Hood	\$104.55	\$110.70	\$123.00
K	47-4094	Fume Extraction Flex Arm w/Cone	\$80.75	\$85.50	\$95.00
	47-4064	Fume Extraction Flex Arm w/Cone bracket	\$164.05	\$173.70	\$193.00

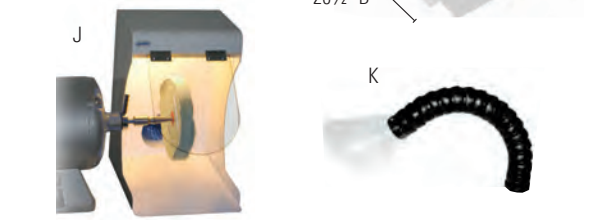



QUATRO ACCESSORIES

Item	Order #	Description	1+
A	47-4218	Dual LED Light Kit	\$119.00
B	47-4104	Upgrade Kit for ClearView	\$74.00
C	47-4095	Slide Bar 2½ in.	\$65.00
D	47-4096	Slide Bar 3 in.	\$44.75
E	47-4039	On/Off Foot Pedal	\$98.00
	47-4752	Replacement Flaps (2 Pair)	\$28.95

HICAP

High capacity debris collection similar to the velocityX4. Lower maintenance required, due to high capacity precious metals storage. Comes with legs and plastic pail for easy debris removal. Quatro benefits of a proven design:

- Highest and most effective dust retention
- 99.9% filter efficiency
- Maintenance-friendly design, filter accessed and cleaned in seconds
- High capacity precious metals debris storage allows for lower maintenance
- Brushless motor, no motor maintenance

Dimensions with intake hood: 28" W x 6" H x 18" D

Weight: 50 lbs operating Voltage: 115/1/60, 1.6 amps (also available in 240/1/50)
CFM:800



Order #	Description	W x H x D	12+	6+	1+
47-4182	4 Port Dust Collector	22½" x 20" x 13½"	—	—	\$1,895.00
47-4183	8 Station Collector	22½" x 20" x 13½"	—	—	\$2,320.00
47-4049	Pre-Filters (Pack of 20)		\$47.60	\$50.40	\$56.00
47-4048	Replacement Cartridge Filter		\$100.30	\$106.20	\$118.00
47-4033	On/Off Remote		\$40.80	\$43.20	\$48.00

QUATRO BASIC DUST COLLECTOR

Mini dust collector with high speed turbine motor. Small footprint for tight spaces. Both are 23lbs.

Order #	Description	W x L x H	1+
47-4201	Basic with Foot Pedal	7" x 16" x 10"	\$399.95
47-4201	Basic with On/Off Switch	7" x 16" x 10"	\$399.95



Find added video content on Stuller.com.





QUATRO CB POLISHER

- Three-stage filtration: rouge prefilter, extra surface dust filter, true 99.97% HEPA filter
- Designed for use with inside ring polishers
- Built-in air purifier to purify the air in the room when you are not polishing
- Cool Blue Filtered Polishing Motor has emergency "safety-off" switch
- Vibration isolated polishing motor for extra quiet operation
- Extra large debris capture/intake area
- Extra large protection shield
- Illuminated work surface
- Includes 1/2" straight shaft spindles
- 300 CFM

Order #	Description	W x L x H	1+
47-4208	Table Top Polisher	9" x 20" x 9"	\$699.00



30 lbs

QUATRO GOLD VAULT

Compact dust collector. Total collection inside the filter, no precious metal waste. Whisper quiet. Comes with bag and refillable cartridge filter. Ideal for repair shops or any other areas where engraving, grinding, polishing, and mixing investments will be done. Electrical requirements: 120/1/60-7amps or 230/1/50-4amps.

Control panel: fused for current protection

- Small footprint for tight spaces
- High speed turbine
- Reusable cartridge filter
- Easily disposable bag filter collects all precious metals inside bag
- Includes 6ft of heavy duty 1.5" hose and clamps
- CFM 150

Order #	Description	W x L x H	Per Unit	1+
47-4172	Dust Collector	9" x 20" x 9"	Each	\$648.00
47-4176	Box Filter		Each	\$90.80



QUATRO iVAC

Designed for systems that generate large volumes of dust, the iVAC is an intelligent "next generation" dust collector with Filter Cleaning System (FCS). FCS is fully automatic, self activating, and hands-free and sends accumulated dust from the filter into the collector as needed. Fully digital control panel indicates filter replacement and maintenance cycles. Built-in "slide & glide" collector accumulates 6 gallons.

Order #	Description	W x L x H	1+
47-4240	iVAC	15" x 20" x 29"	\$2,150.00
47-4044	Filter	12" x 12"	\$104.00
47-3990	HEPA Filter		\$72.00



28 lbs

QUATRO JET STREAM

The Quatro Jet-Stream is a quiet, compact and powerful dust collector. It is easy to connect to your bench or workstation to help keep your breathing zone clean and free of particulate matter. The Jet-Stream uses a two-stage filtering system that starts with an easy access replaceable bag filter that captures larger particulates and then an OSHA approved HEPA filter that will remove particulate matter down to sub-micron particulate levels. Compact and comes with bag filter and HEPA filter. Whisper quiet—ideal for engraving applications or small repairs.

Order #	Description	W x L x H	Per Unit	1+
47-4195	Jet Stream	10" x 14" x 12"	Each	\$699.00
47-4196	Filter Bags		Pack of 5	\$55.20
47-4198	Brushes		Pack of 2	\$20.00

BEST BUILT ENCLOSED POLISHER

The Best Built polishing system comes with a ¾ hp fully sealed, heavy duty, permanently lubricated ball bearing polishing motor.

The hoods have efficient, cool fluorescent lighting. Lights are enclosed behind a glass shield, which protects and keeps the bulbs clean. With a unique double filter system, it combines the technology of a dense, pleated filter with a tightly woven cotton bag filter, ensuring maximum recovery.

- ½ hp suction motor creates 450 CFM
- Rust-proof spindles
- Heavy-duty 12 gauge steel cabinet
- 110 volts/20 amps
- Access for hands can be customized

BEST BUILT MOTORS

- Fully sealed ball bearing motor
- ½" straight shaft
- Rust resistant spindles



Item	Order #	Description	W x L x H	1+
A	47-4408	Enclosed Double Unit	37" x 22" x 52"	\$1,995.00
B	47-4401	Single Polisher	26" x 22" x 52"	\$1,500.00
C	47-4405	Polishing Hood	15¾" x 17" x 16¾"	\$275.00
D	47-4400	Double Spindle Unit	41½" x 19¾" x 52"	\$1,995.00
E	47-4406	¾ hp Single Spindle Motor		\$299.00
F	47-4407	¾ hp Double Spindle Motor		\$319.00
	47-4399	Top Only		\$1,295.00
	47-4409	Filter (Pleated)		\$100.00
	47-4402	Dust Collector Bag		\$12.00
	47-4404	Dust Collector Bag		\$16.00



A



B



C



D



E



F



STULLER TABLE-TOP LARGE DOUBLE SPINDLE POLISHER

Squirrel cage blowers provide the strongest suction in their class. Sealed and insulated cabinets provide maximum dust collector efficiency. Quick and easy filter replacement. Totally sealed and permanently lubricated. Unique tapered and threaded shaft design virtually eliminate all vibration. Capable of handling up to 8" diameter buffs. Bulbs not included.

Item	Order #	Description	W x L x H	1+
A	47-4993	Large Double Polisher	32½" x 22" x 12"	\$495.00
B	47-4994	Double Polisher	22½" x 17" x 12"	\$389.00
C	47-4995	Single Polisher	15" x 17" x 10"	\$339.00

ACCESSORIES

47-4147	Double Spindle Motor	15" x 17" x 10"	\$205.00
47-4142	Tapered Spindle Right		\$9.00
47-4141	Tapered Spindle Left		\$9.00
47-4148	Single Spindle Motor	15" x 17" x 10"	\$184.00
47-4127	Replacement Single Filters (Pack of 3)	9¾" x 13" x 2"	\$28.35
47-4128	Replacement Double Filters (Pack of 3)	12" x 22½" x 2"	\$33.95
47-4129	Replacement Large Filters (Each)	11¾" x 29¾" x 2"	\$16.85

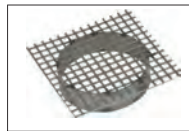

POLISHING HOOD

Designed and manufactured to complement dust collectors, the polishing hood maximizes the direction of airflow promoting maximum efficiency. The hood is fabricated out of heavy gauge sheet metal and has a powder coated finish.

Item	Order #	Description	1+
D	47-4769	Incandescent Polishing Hood w/Light	\$105.95
E	47-4145	Socket for Incandescent Hood	\$10.55
F	47-4146	3" Screen Inlet for Polishing Hood	\$9.50



STULLER SPLIT LAP MACHINE WITH TABLE

Tapered spindle lapping machine has 45° angle design to provide optimum visibility. Dual 3" flanges allow the introduction of two-sided dust collection. Spindle included. Motor hp: ½

Item	Order #	Description	W x L x H	1+
G	47-7000	Lapping Machine	24" x 14" x 38"	\$379.00
H	47-7001	Lapping Hood	17" x 18" x 24"	\$329.00
J	47-7006	Lapping Machine w/Table	16" x 24" x 18"	\$845.00
	47-4140	Replacement Spindle (Left) (5/8" ID x 6" L)		\$16.85

SPLIT LAP

Multi-laminated. Flexible. Impregnated cotton split laps with aluminum-oxide abrasive grains. Smooth, controlled, cool grinding action produces a consistent finish on most metals.

Item	Order #	Grit	OD	ID	Thickness	12+	6+	1+
A	17-5011	180	6"	3/8"	1/4"	\$36.20	\$37.78	\$39.35
B	17-5013	120	6"	3/8"	1/4"	\$36.20	\$37.78	\$39.35



MARATHON SPLIT LAP

Each wheel is balanced, with holes in the precise center to ensure smooth operation. Perfectly concentric slits provide outstanding visibility of the item being polished.

Item	Order #	Grade	Diameter	Thickness	12+	6+	1+
C	17-9460	Medium	6"	1/2"	\$27.03	\$28.62	\$31.80
D	17-9470	Hard	6"	1/2"	\$30.81	\$32.63	\$36.25
E	17-9480	Rock Hard	6"	1/2"	\$33.41	\$35.37	\$39.30
F	17-9490	Flint Hard	6"	1/2"	\$35.15	\$37.22	\$41.35

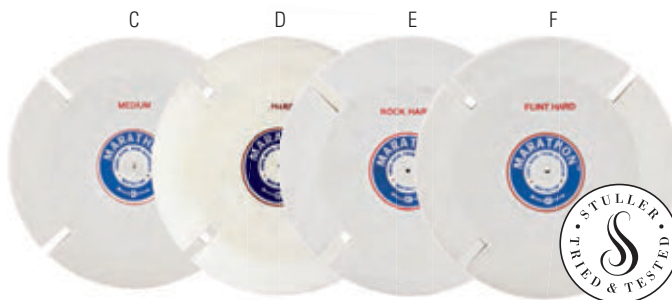

SILICONE SPLIT LAP

Requires no rouge or tripoli. Each wheel is impregnated with carefully graded silicone-carbide abrasive.

Item	Order #	Description	Grade	Diameter	12+	6+	1+
G	17-5027	White Silicone	Coarse	6"	\$48.15	\$50.99	\$56.65
H	17-5028	Black Silicone	Medium	6"	\$48.15	\$50.99	\$56.65
J	17-5029	Blue Silicone	Fine	6"	\$48.15	\$50.99	\$56.65
K	17-5030	Pink Silicone	Extra Fine	6"	\$48.15	\$50.99	\$56.65

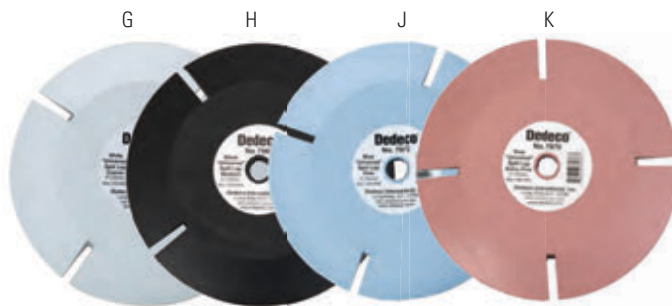

PARAMOUNT FELT SPLIT LAPS

The industry standard. All come with pinhole centers.

Order #	Grade	Diameter	Thickness	12+	6+	1+
17-9560	Medium	6"	1/2"	\$34.60	\$36.63	\$40.70
17-9562	Medium	6"	1/2"	\$36.42	\$38.57	\$42.85
17-9570	Hard	6"	1/2"	\$36.44	\$39.51	\$43.90
17-9580	Rock Hard	6"	1/2"	\$49.77	\$51.94	\$54.10
17-9590	Flint Hard	6"	1/2"	\$49.27	\$51.41	\$53.55



SILICONE 6 INCH SPLIT LAPS

Very clean, no rouge. Excellent finish.

Order #	Description	Grit	12+	6+	1+
17-5025	Pre-Polish	100	\$57.21	\$60.57	\$67.30
17-5026	Polish	180	\$57.21	\$60.57	\$67.30

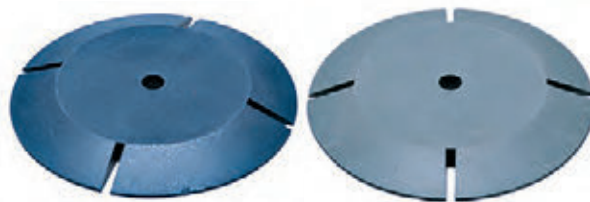

SPANISH FELT SPLIT LAP WHEEL

These high-grade wheels are excellent for all-purpose polishing and buffing. Made in the USA.

Order #	Description	Diameter	Thickness	12+	6+	1+
17-5000	Split Lap	4"	1/2"	\$16.05	\$16.75	\$17.45





A. Complete solution for grinding, high precision honing, sharpening, and polishing. Sharpen carbide and grind exotic metals with 3M™ Diamond Abrasives. Excellent for any metal or wood applications. The included Cushion Pads allow higher accuracy and longer abrasive life. The brush permits polishing of crevices and contoured areas on any metal.

- 12 Ninja SEE-THRU™ Backpads
- 9 Ninja Cushion Pads: 3M™ Bumpon™
- 3M™ Microfinishing Diamond™: 74, 45, 30, 20 Micron
- 3M™ Purple Ceramic™: 80, 120, 220 Grit
- 3M™ Trizact™: 35, 20, 10, 5 Micron
- Ninja™ SEE-THRU™ felt disc
- Jooltool™ Polishing Compound
- 3M™ 3" Bristle Brush: 1 Micron (polishing)
- Instructional DVD

B. The ideal solution for grinding, high precision honing, sharpening, and polishing. Great for metal and wood applications. The included Cushion Pads allow higher accuracy and longer abrasive life. The brush permits polishing of crevices and contoured areas on any metal.

- 4 Ninja SEE-THRU™ Backpads
- 3 Ninja Cushion Pads: 3M™ Bumpon™
- 3M™ Purple Ceramic™: 80, 120, 220 Grit
- 3M™ Trizact™: 35, 20, 10, 5 Micron
- Ninja™ SEE-THRU™ felt disc
- Jooltool™ Polishing Compound
- 3M™ 3" Bristle Brush: 1 Micron (polishing)
- Instructional DVD

C. Perfect as a start-up package, this kit includes grinding, sharpening and polishing abrasives. Great for metal and wood applications.

- 3 Ninja SEE-THRU™ Backpads
- 3M™ Purple: 80, 120, 220 Grit
- 3M™ Trizact™: 35, 20, 10, 5 Micron
- Ninja™ SEE-THRU™ felt disc
- Jooltool™ Polishing Compound
- Instructional DVD

THE JOOLTOOL FINISHING SYSTEM

The JoolTool™ is a revolutionary, compact, multi-functional tool perfect for grinding, sharpening, sanding, deburring, polishing, and much more. The JoolTool™ will help hobbyists and industrial professionals conquer any job. And in most instances they can replace the need for conventional bench grinders, belt sanders, sharpeners, etc. Why spend needlessly when the JoolTool™ can do it all.

- Speed: variable - 500 to 5,000 RPM
- HP: 1/20 Horsepower
- Voltage: 110 DC
- Vent: 1.5" diameter (for optional vac hookup)
- Max. Wheel Diameter: 3" (Recommended)
- Dimensions: 12" tall x 8" diameter
- Fuse Protected: 5 amp (replaceable)
- Manufactured: USA

Item	Order #	Description	1+
A	47-5296	Deluxe Kit	\$495.00
B	47-5299	Pro Kit	\$375.00
C	47-5300	Basic Kit	\$270.00
ACCESSORIES		Micron	Per Pack 1+
	47-5311	Combo Kit	(Each) \$70.25
	47-5312	Polishing Kit	(3 Each) \$21.80
	47-5305	Green Disk	A-35 μ (6 Pack) \$20.15
	47-5306	Red Disk	A-20 μ (6 Pack) \$20.15
	47-5307	Blue Disk	A-10 μ (6 Pack) \$20.15
	47-5308	Orange Disk	A-5 μ (6 Pack) \$20.15
		Grit	Per Pack 1+
	47-5304	Purple Disk	220 (6 Pack) \$19.15
	47-5313	Diameter Disk	220 (2 Pack) \$21.95
	47-5309	Purple Asst.	80, 120, 220 (3 Each) \$41.65
	47-5310	Trizact™ Asst.	35, 20, 10, 5 (3 Each) \$47.50
		Grade	Per Pack 1+
	47-5324	Scotch Brite Unitized Kit	Coarse, Medium, Fine (Set of 3) \$81.60
	47-5325	Flex Shaft Attachment	(Each) \$29.58
	47-5301	Black Pad	(3 Pack) \$42.20
	47-5319	3 Buff & Polish Felt	(Each) \$39.35

BALDOR POLISHING LATHE

Completely enclosed and also uses moisture-resistant copper wiring in the stator winding to provide longer life. Balanced rotor and shaft provides vibration-free and quiet operation. Ball bearings are lubricated for life and sealed to be protected from dust and dirt. Limited 3-year manufacturer's warranty. Ships UPS.

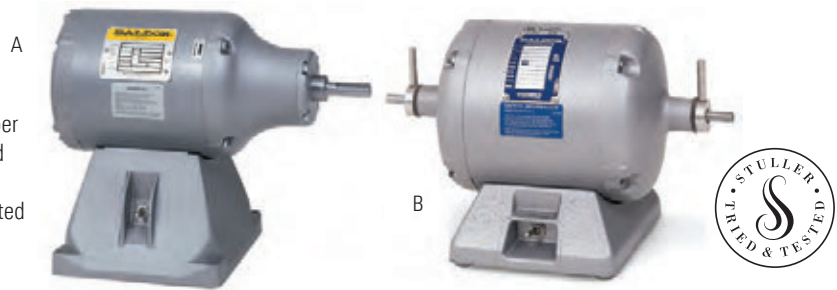

Item	Order #	Description	Motor Speed	Spindle	HP/V/Hz	RPM	Model	Shaft Diameter	Shaft Height	Lathe Size	Weight	1+
A	47-4024	One Spindle Lathe	1	1	¼ hp, 115/60 Hz	3,450 RPM	LPL75	5/8"	8"	14½"	48 lbs	\$495.00
	47-4023	One Spindle Lathe	1	1	½ hp, 115/60 Hz	3,450 RPM	LPL50	5/8"	8"	14½"	43 lbs	\$415.00
B	47-4021	Two Spindle Lathe	1	1	½ hp, 120/60 Hz	3,450 RPM	359T	3/8"	5¼"	14½"	36 lbs	\$425.00
	47-4008	Two Spindle Lathe	2	2	¼ hp, 120/60 Hz	3,600/1,800 RPM	340	3/8"	4 11/16"	13 1/8"	32 lbs	\$395.00
	47-4019	Two Spindle Lathe	2	2	¼ hp, 120/60 Hz	3,450/1,725 RPM	353T	3/8"	4 11/16"	14 1/3"	35 lbs	\$425.00



STULLER TABLE-TOP LARGE DOUBLE SPINDLE POLISHER

High base heavy-duty motor, totally sealed and permanently lubricated ball bearings. Unique tapered and threaded shaft design virtually eliminate all vibration. Capable of handling up to 8" diameter buffs.

Item	Order #	Description	Motor Speed	Spindle	HP/V	RPM	Shaft Diameter	Shaft Height	Lathe Size	Weight	1+
C	47-4149	Single Spindle Lathe	1	1	¼ hp	3,450	5/8" thread	7"	11" x 13"	45 lbs	\$345.30
D	47-4150	Double Spindle Motor		2	¼ hp	3,450	5/8" thread	7"	11" x 16"	49 lbs	\$369.10
E	47-4148	Single Spindle Motor	1	1	½ hp	3,450	½" screw	9" x 6"		19 lbs	\$184.00
F	47-4147	Double Spindle Motor	2	2	½ hp	3,450	½" screw	12" x 6"		22 lbs	\$205.00

REDWING POLISHING LATHE

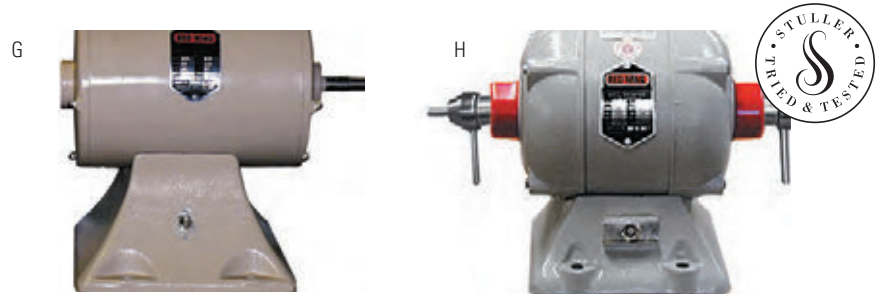

Item	Order #	Description	Motor Speed	Spindle	HP/V/Hz	RPM	Model	Shaft Diameter	Shaft Height	Weight	1+
G	47-4020	One Spindle Lathe	1	1	½ hp, 115/60 Hz	3,450	30	5/8" straight	6 3/8"	36 lbs	\$315.95
H	47-4025	Two Spindle Lathe	2	2	¼ hp, 115/60 Hz	3,450	26	5/8" thread	6 3/8"	41 lbs	\$315.95

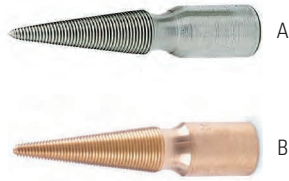

TAPERED SPINDLES FOR BALDOR MOTORS

Spindles are made from tool steel (HR 32-38), and are machined allowing for perfect center. This minimizes vibration from the spindles. Spindles are nickel-plated to prevent corrosion. For use with Baldor™ motors only.

Item	Order #	Description	Material	Length	12+	6+	1+
A	47-2308	Right Thread	Steel	¾"	\$8.00	\$8.35	\$8.70
	47-2309	Left Thread	Steel	¾"	\$8.00	\$8.35	\$8.70
B	47-2304	Right Thread	Brass	¾"	\$36.16	\$37.73	\$39.30
	47-2305	Left Thread	Brass	¾"	\$36.16	\$37.73	\$39.30



TAPERED SPINDLES FOR PRO-SERIES MOTORS

Item	Order #	Description	ID	Length	12+	6+	1+
C	47-4141	Tapered Spindle Left	½"	3½"	\$7.65	\$8.10	\$9.00
	47-4142	Tapered Spindle Right	½"	3½"	\$7.65	\$8.10	\$9.00
D	47-4144	Tapered Spindle Left	⅝"	6"	\$17.43	\$18.19	\$18.95
	47-4143	Tapered Spindle Right	⅝"	6"	\$17.43	\$18.19	\$18.95



TAPERED SPINDLES WITH SET SCREW FOR STRAIGHT-SHAFT MOTORS

Individually machined from hardened tool steel. Precision centered and balanced. Tolerances within 0.001". Machine threaded taper hold buffs securely centered for maximum performance. Used to mount soft-wheel buffs onto polishing or lapping motors. Fits any straight-shaft motor. Available with right- or left-handed threads and held to shaft by set screws. Ends are pointed, and threads are clear and deep. Made in the USA.

Order #	Description	Inside Diameter	Length	12+	6+	1+
47-2708	Right Thread	⅝"	5"	\$9.06	\$9.46	\$9.85
47-2710	Right Thread	¼"	4"	\$9.06	\$9.46	\$9.85
47-2712	Right Thread	⅜"	4"	\$11.22	\$11.71	\$12.20
47-2713	Left Thread	⅜"	4"	\$9.06	\$9.46	\$9.85
47-2714	Right Thread	½"	4"	\$9.06	\$9.46	\$9.85
47-2715	Left Thread	½"	4"	\$9.06	\$9.46	\$9.85
47-2716	Right Thread	⅝"	4"	\$9.06	\$9.46	\$9.85
47-2717	Left Thread	⅝"	4"	\$9.06	\$9.46	\$9.85
47-2718	Right Thread	¼"	5"	\$9.06	\$9.46	\$9.85
47-2719	Left Thread	¼"	5"	\$9.06	\$9.46	\$9.85
47-2720	Right Thread	⅜"	5"	\$9.06	\$9.46	\$9.85
47-2721	Left Thread	⅜"	5"	\$9.06	\$9.46	\$9.85
47-2722	Right Spindle	½"	5"	\$9.06	\$9.46	\$9.85
47-2723	Left Spindle	½"	5"	\$9.06	\$9.46	\$9.85
47-2725	Left Thread	⅝"	5"	\$9.06	\$9.46	\$9.85

BENCH TOP POLISHER

Polisher has pre-lubricated ball bearings and a dust-proof motor housing that makes it virtually maintenance free. The user will not sacrifice quality or speed with this well-balanced precision polisher. Works with standard wheels and buffs up to 4". Includes:

- Two 5/16" tapered spindles
- Two replacement motor brushes
- Two medium abrasive wheels
- 110 volt, 1/6 hp motor. UL listed.



Order #	Description	12+	6+	1+
34-1000	Bench Top Polisher	\$79.47	\$84.15	\$93.50

FOREDOM® BL 1 LATHE

High-torque, 1/6 hp lathe with permanent magnet motor sealed in a dustproof housing. Variable speeds from 1,800 to 7,000 RPM. No lubrication of ball bearings needed. Comes with two tapered spindles and tools.



Item	Order #	Description	12+	6+	1+
A	34-2000	Foredom BL 1 Lathe	\$194.65	\$206.10	\$229.00
B	34-2305	Brushes (sold by pair)	\$7.23	\$7.65	\$8.50
C	34-2010	Hood 8 5/8" W x 4 5/8" D x 6 1/2" H	\$42.46	\$44.96	\$49.95

ACCESSORIES

Item	Order #	Description	12+	6+	1+
D	34-2001	Left Tapered Spindle	\$9.75	\$10.18	\$10.60
E	34-2002	Right Tapered Spindle	\$9.75	\$10.18	\$10.60
F	34-2008	Chuck Arbor with Key	\$44.11	\$46.03	\$47.95
G	34-2013	Left Wheel Mandrel	\$15.26	\$16.16	\$17.95
H	34-2014	Right Wheel Mandrel	\$15.26	\$16.16	\$17.95
J	34-2012	Collet Holders w/3 Collets (for right side)	\$19.64	\$20.50	\$21.35

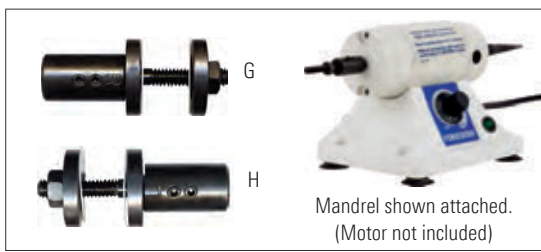

Mandrel shown attached. (Motor not included)

FOREDOM® POLISHING HOOD

This new filter hood was designed for use at the bench in jewelry making, dental laboratories, and industrial operations to collect dust and larger particles produced from light grinding and polishing. The CE compliant hood is made of powder-coated, heavy-gauge steel. It has a removable water-tight metal tray, clear poly carbonate shield, and gooseneck LED light that is bright and long lasting. Three filters come packed with the unit that are easy to change and ship out to a refiner. It can be moved anywhere on a bench-top for use with a flexible shaft handpiece, micro motor, and other bench-top tools. Despite its small size, the filter hood offers strong suction power for removing particles of hazardous dust and reclaiming precious metal.

- Made of powder-coated, heavy-gauge steel
- Voltage selector switch for 110 or 220 operation
- Fan rating of 80 CFM



Find added video content on Stuller.com.

Order #	Description	W x H x D	12+	6+	1+
34-2015	Polishing Hood	6" x 7 1/2" x 12 3/4"	\$225.25	\$238.50	\$265.00
34-2016	Filters (Pack of 5)		\$4.46	\$4.72	\$5.25



Chuck shown attached.
(Motor not included).



BRASS BUR CHUCK

Bur chuck for tapered shaft motors $\frac{5}{32}$ " (4 mm) capacity for right shaft. Brass body with steel knurl.

Order #	Description	12+	6+	1+
47-2605	Brass Bur Chuck	\$18.72	\$19.54	\$20.35



Mandrel shown attached.
(Motor not included).



WOODEN HUB MANDREL

$\frac{1}{8}$ " diameter screw mounted on wooden handle. Heavy duty for right side. For use with tapered spindle.

Order #	Description	12+	6+	1+
47-2600	Wood Hub Mandrel	\$2.02	\$2.11	\$2.20



A



TAPERED CHUCK FOR BRUSHES

For use with tapered spindle on polishing motors. Fits brushes with $\frac{1}{8}$ " holes. Can be threaded onto the hardened, steel taper, which in turn can be threaded onto a standard tapered spindle.



B



Item	Order #	Description	12+	6+	1+
A	47-2590	Left-Handed	\$3.13	\$3.26	\$3.40
B	47-2580	Right-Handed	\$3.13	\$3.26	\$3.40



C



PLASTIC HUB MANDREL

Plastic hub mandrels designed to fit brushes with $\frac{1}{8}$ " arbor hole.

D



Item	Order #	Description	12+	6+	1+
C	47-2608	Right-Handed	\$6.50	\$6.89	\$7.65
D	47-2610	Left-Handed	\$6.50	\$6.89	\$7.65

Chucks and mandrels shown attached.
(Motors not included).



HANDLE WITH CHUCK

Wooden handle with the end bored and reinforced. Small wheels and burs can be used on larger, polishing motors by threading onto tapered spindles. Chuck opens from 0.085" to 0.128". Accommodates $\frac{3}{32}$ " and $\frac{1}{8}$ " mandrels.

Order #	Description	Length	12+	6+	1+
37-7600	Handle with Chuck	3 $\frac{1}{2}$ "	\$8.07	\$8.55	\$9.50
37-7601	Replacement Chuck		\$2.81	\$2.97	\$3.30



E



F

TAPERED WHEEL ADAPTER

Item	Order #	Description	Inside Diameter	Color	1+
E	10-9162	Right Adapter	$\frac{3}{8}$ "	Black	\$2.55
F	10-9163	Left Adapter	$\frac{3}{8}$ "	Gray	\$2.55



TAPERED SPINDLE ADAPTERS

MX Polishing Wheel features a consistent premium grade of silicone-carbide mineral along with brightness enhancers that result in controllable, consistent finishing and polishing of metal parts.

Order #	Description	Inside Diameter	1+
10-8208	Adapter	1"	\$6.10

ROUGES FOR GOLD AND SILVER PRE-FINISHING

TRIPOLI

Coarse cutting compound to remove scratches and surface imperfections. All-Purpose Tripoli cuts similarly to regular tripoli but leaves a brighter finish. Platinum Tripoli is specially formulated to remove scratches from platinum, chromium, stainless steel, and other hard metals.

Item	Order #	Description	Grade	Size	12+	6+	1+
A	47-3250	Tripoli Tube	Aggressive	1 lb	\$2.81	\$2.93	\$3.05
B	47-3255	All-Purpose Tripoli Tube	Extra Fine	1 lb	\$4.23	\$4.42	\$4.60
C	47-3285	Platinum Tripoli Tube	Aggressive	1 lb	\$3.13	\$3.26	\$3.40



GREY STAR

Dry, aggressive compound for removing scratches and imperfections. Works well on brass, gold, silver, and stainless steel, leaving a uniform finish. Made of very fine uniform abrasives, produces good cut with no mild scratches. May be used for cut and color as one step.

Item	Order #	Description	Grade	Grit	Size	12+	6+	1+
D	47-3297	Bar	Medium Coarse	800	1 lb	\$4.23	\$4.42	\$4.60

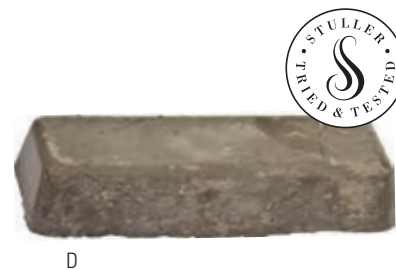

TRIPOLI

Superior cutting and color compound for soft metals such as gold, silver, and brass. 600 grit.

Item	Order #	Description	Grade	Size	12+	6+	1+
E	47-3280	Luminescence Tripoli Tube	Fine	1 lb	\$3.91	\$4.08	\$4.25
F	47-3281	White 3XXX Bar	Fine	1 lb	\$2.35	\$2.45	\$2.55
G	47-3282	White 4XXX Bar (finer abrasives)	Extra Fine	1 lb	\$1.98	\$2.06	\$2.15



BOBBING COMPOUND

Aggressive on soft metals such as gold, silver, aluminum, and brass. Adheres extremely well to buffs when using laps and bristle brushes. Fast and heavy cutting.

Item	Order #	Description	Grade	Grit	Size	12+	6+	1+
H	47-3290	Tube	Medium	600	1 lb	\$2.62	\$2.74	\$2.85
J	47-3291	Bar	Medium	600	1 lb	\$2.35	\$2.45	\$2.55



TRIPOLI

Fast cutting on all non-ferrous metals. Formulated to produce excellent results with quick and easy cleanup.

Item	Order #	Description	Grade	Grit	Size	12+	6+	1+
K	47-3257	Bar	Coarse	240	2¼ lb	\$3.44	\$3.65	\$4.05





A



B



C



D



E



F



G



H



J



K



L



M



N



P

ROUGES FOR GOLD AND SILVER FINISHING

WATER SOLUBLE ROUGE

Water-soluble polishing rouges, formulated to produce excellent results with quick and easy cleanup.

Item	Order #	Description	Grade	Grit	Color	12+	6+	1+
A	47-3274	½ lb Bar	Medium Fine	6000	Green	\$9.14	\$9.68	\$10.75
B	47-3276	½ lb Bar	Medium	1200	Yellow	\$2.53	\$2.64	\$2.75

GREEN ROUGE

Specially formulated for silver, stainless steel, platinum, white gold, and rhodium. Sold in tubes or by bars. Produces a high luster for a final finish. Clean working leaving little residue.

Item	Order #	Description	Grade	12+	6+	1+
C	47-3210	8 oz Tube	Medium Fine	\$2.35	\$2.45	\$2.55
D	47-3215	16 oz Tube	Medium Fine	\$5.47	\$5.71	\$5.95
E	47-3211	¼ lb Bar	Medium Fine	\$3.36	\$3.65	\$4.05

ROUGES FOR GOLD AND SILVER FINAL FINISHING

WATER SOLUBLE ROUGE

Water-soluble polishing rouges, formulated to produce excellent results with quick and easy cleanup.

Item	Order #	Description	Grade	Grit	Color	12+	6+	1+
F	47-3236	1 lb Bar	Extra Fine	1500	Red	\$5.52	\$5.76	\$6.00
G	47-3222	1 lb Bar	Fine	1200	Blue	\$3.31	\$3.46	\$3.60

RED ROUGE

Industry standard for a deep luster, final finish for gold, silver, and brass. Completely free of grit or other coarse matter. Provides a mirror finish on metal after prior cut down.

Item	Order #	Description	Grade	Grit	12+	6+	1+
H	47-3230	8 oz Tube	Extra Fine	—	\$4.55	\$4.75	\$4.95
J	47-3235	16 oz Tube	Extra Fine	—	\$4.65	\$5.04	\$5.60
K	47-3236	1 lb Bar	Extra Fine	1500	\$5.52	\$5.76	\$6.00

BLACK ROUGE

Produces a rich, darker luster on white gold, silver, and platinum. Highly recommended for silver.

Item	Order #	Description	Grade	12+	6+	1+
L	47-3200	8 oz Tube	Fine	\$3.91	\$4.08	\$4.25
M	47-3205	16 oz Tube	Fine	\$4.60	\$4.80	\$5.00

YELLOW ROUGE

Excellent for an ultra-bright final finish on yellow gold and hard metals. Less greasy and cleaner to use than most other rouges.

Item	Order #	Description	Grade	12+	6+	1+
N	47-3270	8 oz Tube	Extra Fine	\$3.20	\$3.47	\$3.85
P	47-3275	16 oz Tube	Extra Fine	\$4.69	\$5.09	\$5.65

ROUGES FOR TITANIUM FINISHING

TITANIUM POLISH

Titanium polish in different grades for use on your titanium metals.

Item	Order #	Description	12+	6+	1+
A	47-3299	16 oz TP-100 Bar	\$18.02	\$19.08	\$21.20
B	47-3300	16 oz TP-200 Bar	\$19.89	\$21.06	\$23.40
C	47-3301	16 oz TP-300 Bar	\$11.31	\$11.97	\$13.30
D	47-3302	16 oz TP-400 Bar	\$15.46	\$16.13	\$16.80

ROUGES FOR PLATINUM FINISHING

PRE-FINISHING Use Tripoli or Graystar for your platinum pre-finishing. See page 443 for our complete line of pre-finishing rouges.

PICASSO BLUE

Ultra-bright finish for platinum and gold.

Item	Order #	Description	Color	12+	6+	1+
E	47-3246	¼ lb Bar	Picasso Blue	\$20.74	\$21.96	\$24.40

ULTRA BLUE POLISH

For platinum and other white metals.

Item	Order #	Description	Grit	Color	12+	6+	1+
F	47-3247	1 lb Bar	1000	Light Blue	\$4.17	\$4.41	\$4.90

PLATINUM COMPOUNDS

Specially formulated compounds for platinum polishing. Blue Platinum removes light scratches and prepares for final polishing of platinum.

Item	Order #	Description	Grit	Color	12+	6+	1+
G	47-3271	¼ lb Bar	1000	Blue	\$10.16	\$10.76	\$11.95

PLATINUM POLISH

Water-soluble polishing rouges, formulated to produce excellent results with quick and easy cleanup.

Item	Order #	Description	Grit	Color	12+	6+	1+
H	47-3380	1 lb Bar	800	White	\$5.00	\$5.63	\$6.25

BRIGHT-WHITE PLATINUM

Breakthrough for platinum polishing. This new, white compound is much easier than existing compounds. Easy cleanup and leaves little residue.

Item	Order #	Description	Grit	12+	6+	1+
J	47-3266	¼ lb Bars Polishing Compound	800	\$5.43	\$5.66	\$5.90

PLATINUM POLISH

Works extremely well on platinum and gold by cutting the polishing time in half. It is oil-less and greaseless. Tried and tested at Stuller.

Item	Order #	Description	Grit	12+	6+	1+
K	47-3385	1 lb Bars Platinum Polish	1000	\$4.66	\$5.32	\$6.65





MERARD POLISHING SOLUTION

Stuller is now able to offer you a polish that has been tried, tested, and used in our own manufacturing processes. The Merard brand of polish has outperformed all other polishes it been put up against. Stuller has taken it one step further by matching the proper buff to the polish. Exclusively from Stuller we bring you polishing solutions from Merard, the industry leader in polishing compounds and buffs. Top manufactures of fine luxury watches have now implemented this polishing solution into their processes especially for gold and stainless steel watch cases. Now it is available to you. Step 1- Avivor (47-3223) polish in conjunction with TPB buff (47-3228) Step 2- Oras (47-3225) polish in conjunction with STV buff (47-3229) For best results use a variable speed motor (47-2701) at 1800 RPM with light pressure.

Item	Order #	Description	Volume	12+	6+	1+
A	47-3223	Avivor	8 oz	\$12.93	\$13.49	\$14.05
B	47-3225	Oras	8 oz	\$12.93	\$13.49	\$14.05

LUXOR® POLISHING ROUGE

Luxor Red has 6.5 micron grit and is used for preparation (high) and can be used on all metals, but it is an especially excellent pre-polish for platinum.

Luxor White has .3 micron grit and is used for fine polishing and finishing and can be used with steel, stainless steel, silver, gray gold, white gold, and platinum.

Luxor Yellow has .5 micron grit and is used for finishing and can be used on all kinds of gold, steel and stainless steel.

Luxor Orange has .1 micron grit and is used for super finishing and can be used on precious metals and lacquers.

With the Luxor line you will:

- Save time and use less
- Have a cleaner piece with fewer residues
- Have a cleaner work area
- Use with 17-5565

They are smaller bars because you use less and they are easier to use.



Order #	Description	Micron	Volume	12+	6+	1+
47-3224	Pink	6.5 μ	8 oz	\$8.33	\$8.69	\$9.05
47-3224	White	0.3 μ	8 oz	\$8.33	\$8.69	\$9.05
47-3224	Yellow	0.5 μ	8 oz	\$8.33	\$8.69	\$9.05
47-3224	Orange	0.1 μ	8 oz	\$8.33	\$8.69	\$9.05

LUXOR® KIT

Luxor Buff and Polishing Kit consist of the four Luxor polishes, pink, white, yellow, and orange. These are ultra-high quality polishes. Also the kit comes with the 4 inch TPB cotton buff and a 4 inch STV cotton buff.

The four polishes that come with this kit are used for the following:

- **Luxor Pink** is used for preparation (high) and can be used on all metals, but is especially good for platinum
- **Luxor White** is used for fine polishing and finishing and can be used with steel, stainless steel, silver, gray gold, white gold, and platinum
- **Luxor Yellow** is used for finishing and can be used on all kinds of gold, steel and stainless steel
- **Luxor Orange** is used for super finishing and can be used on precious metals and lacquers

Order #	Description	12+	6+	1+
47-3221	4 Polish, 2 Buff Ultimate Polishing Kit	\$75.03	\$78.29	\$81.55



NEW HIGH QUALITY BUFFS

LUXOR® MOC2 BUFFS

The softest Luxor buff made of white flannel scraped on two sides and extremely versatile. This buff can be used with Avivor, Oras, as well as Luxor White, Yellow and Orange polishing compounds. This buff is especially effective on Gold, Titanium, Platinum, and Silver jewelry.

Order #	Grade	Diameter	Thickness	12+	6+	1+
47-3227	Extra Soft	6"	1"	\$20.61	\$21.50	\$22.40
47-3227	Extra Soft	4"	½"	\$14.03	\$14.64	\$15.25

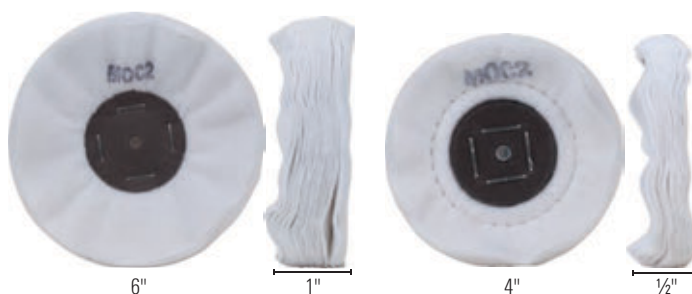

LUXOR® TPB BUFFS

A bleached "shirting" material watch polishing buff used in combination with Avivor as the first step in the finest polishing process for watch cases. Also used with Luxor White for more delicate white metal jewelry pieces (Stainless Steel, Silver, White Gold, and Platinum)

Order #	Grade	Diameter	Thickness	12+	6+	1+
47-3228	Medium	6"	1"	\$32.80	\$34.22	\$35.65
47-3228	Medium	4"	½"	\$14.35	\$14.98	\$15.60



LUXOR® STV BUFFS

An extremely versatile buff of glazed Percale material. It is recommended for the second step of fine watch case polishing in conjunction with Oras. Also used with Luxor White for white metal jewelry pieces, Luxor Yellow for gold and steel, and Luxor Orange for precious metals, and even suitable for use with Avivor.

Order #	Grade	Diameter	Thickness	12+	6+	1+
47-3229	Soft	6"	1"	\$28.11	\$29.33	\$30.55
47-3229	Soft	4"	½"	\$14.54	\$15.17	\$15.80

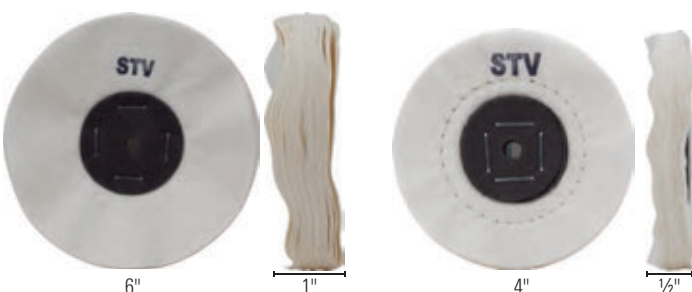

LIQUID POLISH FOR VIBRATORY FINISHING

This revolutionary new liquid polish is used with dry untreated walnut shell. Use approximately 2 tablespoons of liquid in a 1 cubic foot tumbler. Tumble for 6 to 8 hours.

Order #	Description	Color	Volume	12+	6+	1+
47-3226	Step 1: Fine Polish	White	1 kg	\$18.72	\$19.54	\$20.35
47-3226	Step 2: Super Fine Polish	Orange	1 kg	\$21.07	\$21.98	\$22.90





A



B



C



D



E

ROUGES FOR PLATINUM

FINAL FINISHING

PICA PINK

A selected grade of polishing compound formulated for ultra-bright finishing of platinum. Uniformly blended and manufactured under strict quality control. Exceptional adherence to buffs, brushes, or felts.

Item	Order #	Description	Grade	Color	12+	6+	1+
A	47-3245	¼ lb Bar	Extra Fine	Pica Pink	\$17.13	\$18.14	\$20.15

PLATINUM COMPOUNDS

Specially formulated compounds for platinum polishing. Provides the final polish of platinum

Item	Order #	Description	Color	12+	6+	1+
B	47-3267	¼ lb Bar	Pumpkin	\$10.35	\$10.80	\$11.25

CARROT ROUGE

Excellent for platinum. A crocus polishing compound that is an excellent alternative to rouge. This compound has been tested extensively and found to leave a superior finish on platinum. Can also be used on hard plastics and epoxy.

Item	Order #	Description	Color	12+	6+	1+
C	47-3140	¼ lb Bar	Carrot Rouge	\$16.97	\$17.71	\$18.45

WHITE ROUGE

High luster on platinum, white gold, chrome, and stainless steel. Packaged in easy-to-use, clean, peel-away tubes. 800 grit.

Item	Order #	Description	Grade	12+	6+	1+
D	47-3260	8 oz White Rouge Tube	Extra Fine	\$4.05	\$4.22	\$4.40
E	47-3265	16 oz White Rouge Tube	Extra Fine	\$4.55	\$4.75	\$4.95



F



G



H



J

FABULUSTRE AND ZAM POLISHING COMPOUNDS

Fabulustre® - Provides a high luster finish on all types of precious metals. Greaseless, dry, not dusty, which allows for faster clean-up. For use in final buffing.

Zam™ - Excellent rouge alternative. Crocus compound used to polish metals, stones, epoxies, and hard plastics. Will not scratch turquoise or soft stones.

Item	Order #	Description	12+	6+	1+
F	47-3120	¼ lb Fabulustre™ Tube	\$4.05	\$4.22	\$4.40
G	47-3130	1 lb Fabulustre™ Tube	\$5.98	\$6.48	\$7.20
H	47-5020	¼ lb Zam™ Tube	\$3.73	\$3.89	\$4.05
J	47-5030	1 lb Zam™ Tube	\$6.62	\$6.91	\$7.20

ROUGE INFORMATION

Stuller has received several questions about our polishing compounds. The most often asked is whether our compounds are water-soluble. When discussing polishing compounds, the term is sometimes technically incorrect. Stuller's compounds in the tear-away tubes contain similar vegetable and animal fats; however, our compounds are highly saponifiable. Saponifiable means that they will break down or mix with alkalis or soap resulting in easier cleanup. Stuller polishing compounds are made from the highest-quality raw materials. Our compounds are softer than many others are and tend to be more aggressive. This means that less compound is required on the buff. Applying too much compound on your buff is counterproductive, expensive, and may result in the surface of the piece appearing cloudy. Remember the old saying, "A little dab will do you!" You'll find that Stuller offers you a longer-lasting polishing compound with easier cleanup that will save you money all the way around.

DIALUX POLISHING BARS

A select type of super abrasive uniformly blended with a carrier wax. These compounds have special features that allow good adhesion to the fibers of brushes, buffs, or felts. Only minimal quantities need to be used. Bar size 4" x 1 1/4" x 1 1/8".

- Red:** Super finishing composition for gold
- Orange:** Produces a high luster on soft metals
- Yellow:** Gives a bright finish to soft brass, bronze, and copper
- Green:** Super finishing composition for hard metals (chrome and platinum)
- Gray:** Finishing composition for stainless steel
- White:** Finishing for all metals and some plastics in the dental range
- Blue:** Super finishing for all metals and plastics in the dental range



Item	Order #	Description	Grit	Color	12+	6+	1+
A	47-3154	1/4 lb Bar	400	Orange	\$4.80	\$5.09	\$5.65
B	47-3155	1/4 lb Bar	600	Yellow	\$4.80	\$5.09	\$5.65
C	47-3150	1/4 lb Bar	800	Red	\$4.80	\$5.09	\$5.65
D	47-3151	1/4 lb Bar	2000	Green	\$4.80	\$5.09	\$5.65
E	47-3156	1/4 lb Bar	1200	Gray	\$4.80	\$5.09	\$5.65
F	47-3152	1/4 lb Bar	1500	White	\$4.80	\$5.09	\$5.65
G	47-3153	1/4 lb Bar	1800	Blue	\$4.80	\$5.09	\$5.65

WHITE COMPOUNDS

A selected grade of polishing compound formulated for ultra-bright finishing of platinum. Uniformly blended and manufactured under strict quality control. Exceptional adherence to buffs, brushes, or felts. Available in five different grades to achieve surfaces from matte to super shine. Made in Japan.

- **Medium Cut-1500:** For removal of light scratch marks
- **Fine-Cut-4000:** To further improve the surface prior to final finishing
- **Extra Shine-6000:** Enhances the surface to exhibit a bright finish
- **Super Shine-8000:** Provides a very high luster and bright mirror finish



Item	Order #	Description	Grit	12+	6+	1+
H	47-3241	1 lb Medium Cut	1500	\$32.00	\$33.89	\$37.65
J	47-3242	1 lb Fine-Cut	4000	\$34.13	\$36.14	\$40.15
K	47-3243	1 lb Extra Shine	6000	\$34.13	\$36.14	\$40.15
L	47-3244	1 lb Super Shine	8000	\$36.72	\$38.88	\$43.20

KOYO PLATINUM COMPOUNDS

A finishing compound manufactured from carefully graded abrasives, blended with additives to give high reflective surfaces to non-ferrous metals and stainless steels.

- **K-1 Green:** General purpose for preliminary finishing applications
- **K-2 Green:** Intermediate stage finishing compound
- **Alox-5 White:** For final finish, to achieve a distinctive luster



Item	Order #	Description	Color	12+	6+	1+
M	47-3261	1 lb K-1	Green	\$26.56	\$28.13	\$31.25
N	47-3262	1/4 lb K-2	Green	\$11.36	\$11.86	\$12.35
Q	47-3263	1/4 lb Alox-5	White	\$8.46	\$8.96	\$9.95
P	47-3264	1 lb Alox-5	White	\$22.91	\$24.26	\$26.95



BUFF KITS

Stuller is proud to offer Premium Polishing kits that are perfectly suited for the shop's needs. We've drawn from our own production experience. These kits include the same materials we use everyday in our production area.

STARTER BUFF KIT

This kit contains a selection of premium buffs and compounds that are perfect for gold and silver items. Includes: 17-7227 yellow buff, 17-7516 stitched muslin, 17-7726 loose buff, 17-7516 GrayStar, 47-3274 green rouge, 47-3236 red rouge

Item	Order #	Description	12+	6+	1+
A	17-7255	Starter Buff Kit	\$24.10	\$25.52	\$28.35

PLATINUM BUFF KIT

This kit contains a selection of premium buffs and compounds that are perfect for platinum items. Includes: 17-5612 orange buff, 17-7254 purple buff, 17-7726 loose buff, 47-3285 platinum tripoli, 47-3246 picasso blue, 47-3245 pica pink.

Item	Order #	Description	12+	6+	1+
B	17-7257	Platinum Buff Kit	\$57.67	\$61.07	\$67.85

MINIATURES BUFF KIT

Includes: 17-6154 Two mini treated finex muslin buffs, 17-6152 Two mini treated finex muslin buffs, 17-6151 One mini finex muslin buff (pack of 12), 17-3679 One untreated felt wheel (pack of 10), 17-3770 One untreated felt wheel (pack of 100), 17-4904 Two 2" knife edge felt wheels, 43-1280 Three reinforced nickle-plated miniature mandrels, 47-3266 ¼ lb bright white platinum polish, 47-3211 ¼ lb green rouge.

Item	Order #	Description	12+	6+	1+
C	17-1210	Miniatures Buff Kit	\$25.80	\$27.32	\$30.35

MINIATURE BUFF ASSORTMENTS

Contains buffs and mandrels to be used on flex shafts. Two ¾" mandrels, chamois buff, muslin wheel, felt cone, and three wheels are packaged in a plastic box.

Item	Order #	Description	12+	6+	1+
D	17-1270	130 pc Buff Assortment	\$59.62	\$62.21	\$64.80
E	17-1260	6 pc Miniature Buff Assortment	\$5.89	\$6.14	\$6.40

1 PRE-FINISHING BUFFS

ORANGE BUFFING WHEELS

A. Long-lasting, orange buffing wheels are best used for bobbing compounds and platinum tripoli. Thread count 86 x 80.

Order #	OD	Stitching Rows	Ply	12+	6+	1+
17-5607	3"	3	30	\$2.60	\$2.75	\$3.05
17-5608	4"	3	50	\$3.57	\$3.78	\$4.20
17-5609	5"	3	50	\$5.78	\$6.12	\$6.80
17-5610	5"	3	60	\$7.54	\$7.87	\$8.20
17-5611	6"	4	50	\$8.33	\$8.69	\$9.05
17-5612	6"	4	60	\$9.15	\$9.55	\$9.95

PURPLE TREATED MUSLIN BERRY BUFFS

B. Stiff, chemically treated fine-weave muslin buffs with leather centers. Ideal for aggressive compounds and great for platinum.

Order #	Description	OD	Stitching Rows	Ply	12+	6+	1+
17-7250	Knife-Edge	4"	7	12	\$3.73	\$3.89	\$4.05
17-7251	Knife-Edge	6"	10	12	\$4.14	\$4.32	\$4.50
17-7252	Square-Edge	4"	3	40	\$4.23	\$4.42	\$4.60
17-7253	Square-Edge	5"	3	40	\$4.78	\$4.99	\$5.20
17-7254	Square-Edge	6"	4	50	\$6.39	\$6.67	\$6.95
17-7258	Square-Edge	6"	—	50	\$7.13	\$7.44	\$7.75

CHEMKOTE TREATED MUSLIN BUFFS - SQUARE-EDGE STITCHED

C. Yellow 5/8" thick muslin buffs are chemically treated to make them last longer than white muslin. Made from fine-weave muslin with combed edges. Shellac center. Used for cutdown procedure on heavy, rough work.

Order #	OD	Stitching Rows	Ply	12+	6+	1+
17-5533	3"	3	30	\$2.59	\$2.75	\$3.05
17-5544	4"	3	40	\$2.60	\$2.93	\$3.25
17-5545	4"	3	50	\$3.65	\$3.96	\$4.40
17-5546	5"	3	45	\$4.12	\$4.64	\$5.15
17-5560	5"	3	60	\$4.69	\$5.09	\$5.65
17-5565	6"	4	50	\$5.12	\$5.76	\$6.40
17-5566	6"	4	60	\$7.57	\$8.01	\$8.90

CHEMKOTE TREATED MUSLIN BUFF - SQUARE-EDGE LOOSE

D. Leather center.

Order #	OD	Stitching Rows	Ply	12+	6+	1+
17-7200	4"	1	20	\$1.61	\$1.68	\$1.75
17-7203	4"	3	20	\$1.98	\$2.06	\$2.15
17-7224	6"	1	20	\$2.81	\$2.93	\$3.05
17-7227	6"	4	50	\$5.99	\$6.35	\$7.05

CHEMKOTE TREATED MUSLIN BUFFS - KNIFE-EDGE

E. Leather center.

Order #	OD	Stitching Rows	Ply	12+	6+	1+
17-5603	3"	4	9	\$2.30	\$2.43	\$2.70
17-5604	4"	6	12	\$2.82	\$3.06	\$3.40
17-5605	5"	7	12	\$3.74	\$4.05	\$4.50
17-5606	6"	9	12	\$3.87	\$4.10	\$4.55

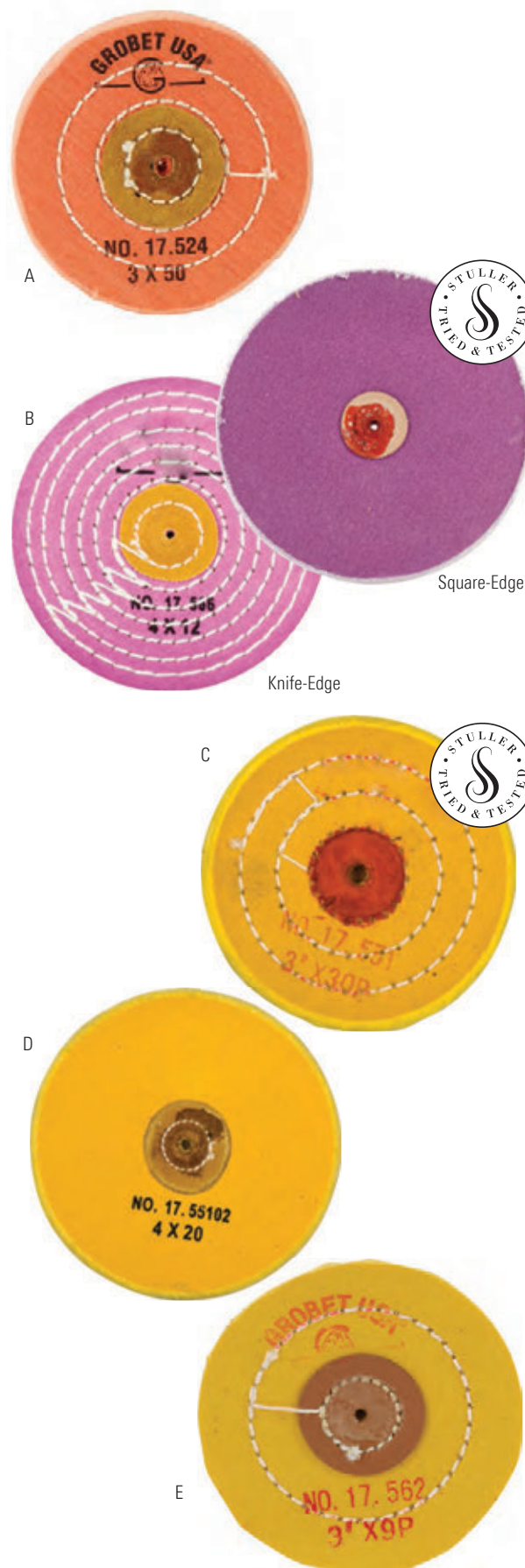

2 FINISHING BUFFS

FINEX COMBED MUSLIN BUFFS

A. Finex muslin has a very tight weave and is very soft. Excellent for use on all rouges. Buffs are chemically treated for longer life and manufactured of fine-weave muslin. All buffs can be used on a tapered spindle. An excellent finishing buff to be used with red rouge. Leather center.

Order #	OD	Stitching Rows	Ply	12+	6+	1+
17-7245	5"	3	20	\$3.91	\$4.08	\$4.25
17-7510	3"	3	35	\$2.49	\$2.70	\$3.00
17-7513	4"	3	30	\$2.60	\$2.93	\$3.25
17-7515	5"	3	45	\$4.36	\$4.91	\$5.45
17-7516	6"	4	50	\$6.28	\$7.07	\$7.85
17-7517	4"	3	50	\$3.36	\$3.65	\$4.05
17-7519	5"	3	50	\$4.72	\$5.31	\$5.90
17-7610	6"	4	60	\$7.72	\$8.69	\$9.65

FINEX COMBED MUSLIN BUFFS

B. Finex combed muslin buff with shellac center. Finex muslin has a very tight weave and is very soft. Excellent for use on all rouges.

Order #	OD	Stitching Rows	Ply	12+	6+	1+
17-6235	3"	3	35	\$1.66	\$1.80	\$2.00
17-6243	4"	4	30	\$2.24	\$2.43	\$2.70
17-6245	4"	4	50	\$2.82	\$3.06	\$3.40
17-6255	5"	3	45	\$3.15	\$3.42	\$3.80
17-6256	5"	5	55	\$3.98	\$4.32	\$4.80
17-6257	5"	3	50	\$4.00	\$4.50	\$5.00
17-6265	6"	4	50	\$4.90	\$5.31	\$5.90
17-6266	6"	6	60	\$5.27	\$5.72	\$6.35

MUSLIN BUFFS

C. All-purpose buffs used for initial polishing. Excellent for use with tripoli and bobbing compounds. Shellac-hardened centers. Stitched, cotton-flannel buffs have soft, thick material for general polishing. Excellent for use on gold and silver.

Order #	Description	OD	Stitching Rows	Ply	12+	6+	1+
17-2005	Cotton-Flannel	4"	3	30	\$3.57	\$3.87	\$4.30
17-2006	Cotton-Flannel	5"	3	30	\$4.57	\$4.95	\$5.50
17-2007	Cotton-Flannel	6"	4	30	\$6.29	\$6.66	\$7.40
17-5713	All-Purpose	4"	3	42	\$2.59	\$2.75	\$3.05
17-5714	All-Purpose	5"	3	45	\$3.44	\$3.87	\$4.30
17-5715	All-Purpose	6"	4	50	\$4.96	\$5.58	\$6.20

KNIFE-EDGE FINEX MUSLIN BUFFS

D. Excellent for polishing areas where conventional buffs cannot reach. Stitching makes edge firm and helps maintain buff shape. Leather center.

Order #	OD	Stitching Rows	Ply	12+	6+	1+
17-6430	3"	3	9	\$2.61	\$2.84	\$3.15
17-6431	4"	5	12	\$4.28	\$4.46	\$4.65
17-6432	5"	7	12	\$3.98	\$4.32	\$4.80
17-6433	6"	9	12	\$3.88	\$4.37	\$4.85



A



B

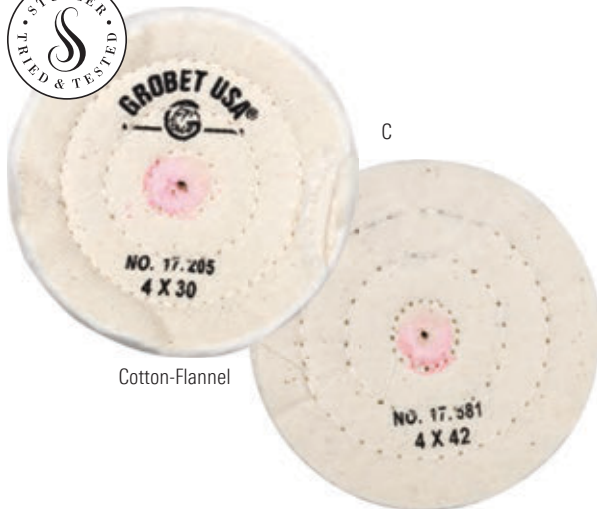

Cotton-Flannel

All-Purpose



D

3 FINAL FINISHING BUFFS

FINEX COMBED MUSLIN BUFFS

A. Finex muslin has a very tight weave and is very soft. Excellent for use on all rouges.

Order #	OD	Ply	Center Type	12+	6+	1+
17-7719	4"	50	Leather	\$4.46	\$4.72	\$5.25
17-7722	5"	50	Leather	\$4.69	\$5.36	\$6.70
17-7726	6"	50	Leather	\$5.43	\$6.20	\$7.75

FINEX COMBED WHITE MUSLIN BUFFS

B. Finex fine-combed, unstitched buffs with hard, plastic center.

Order #	OD	Ply	Center Type	12+	6+	1+
17-7160	3"	36	Plastic	\$2.81	\$2.93	\$3.05
17-7165	4"	36	Plastic	\$3.45	\$3.60	\$3.75
17-7170	5"	54	Plastic	\$4.65	\$4.85	\$5.05
17-7175	6"	54	Plastic	\$5.75	\$6.00	\$6.25

LEAD CENTER MUSLIN BUFFS

C. Loose muslin buffs with lead centers boxed to thread onto tapered spindles. Made in the USA.

Order #	OD	Ply	Center Type	12+	6+	1+
17-7162	3"	36	Lead	\$4.97	\$5.18	\$5.40
17-7163	4"	36	Lead	\$6.12	\$6.38	\$6.65
17-7164	5"	54	Lead	\$9.89	\$10.32	\$10.75
17-7166	6"	54	Lead	\$9.57	\$9.98	\$10.40

HIGH-QUALITY CHAMOIS BUFF

D. Produces a high-mirror finish on precious metals. Also very effective for final mirror finish of platinum when using platinum rouge. Leather center.

Order #	OD	Ply	Center Type	12+	6+	1+
17-1383	3"	12	Leather	\$7.77	\$8.11	\$8.45
17-1384	4"	18	Leather	\$15.04	\$15.70	\$16.35
17-1385	5"	18	Leather	\$23.60	\$24.62	\$25.65

WHITE COTTON FLAP BRUSHES

E. This wheel has cotton flaps inside, with crossed and opposite orientation of the cotton "weft and wrap" more or less at 45° of inclination. These particular properties allow it to polish some metals as cotton discs do, but it also profiles the wheel continuing the polishing operation for a lot of pieces without losing the required and previously given form.

Order #	OD	ID	Thickness	12+	6+	1+
10-7080	4 ³ / ₈ "	1 ¹ / ₄ "	1 ³ / ₁₆ "	\$30.64	\$31.97	\$33.30

GRAY WOOL FLAP BRUSHES

F. "Sister" of the white cotton flap brushes, with the same kind of construction but with flaps of natural selected army wool texture. Particularly suited for polishing metals that need a lot of heating to shine like bronze, copper, silver, and brass (with compound). It maintains the capacity to profile like white cotton flap brushes without losing its form.

Order #	OD	ID	Thickness	12+	6+	1+
10-7090	4 ³ / ₈ "	1 ¹ / ₄ "	1 ³ / ₁₆ "	\$29.58	\$30.86	\$32.15

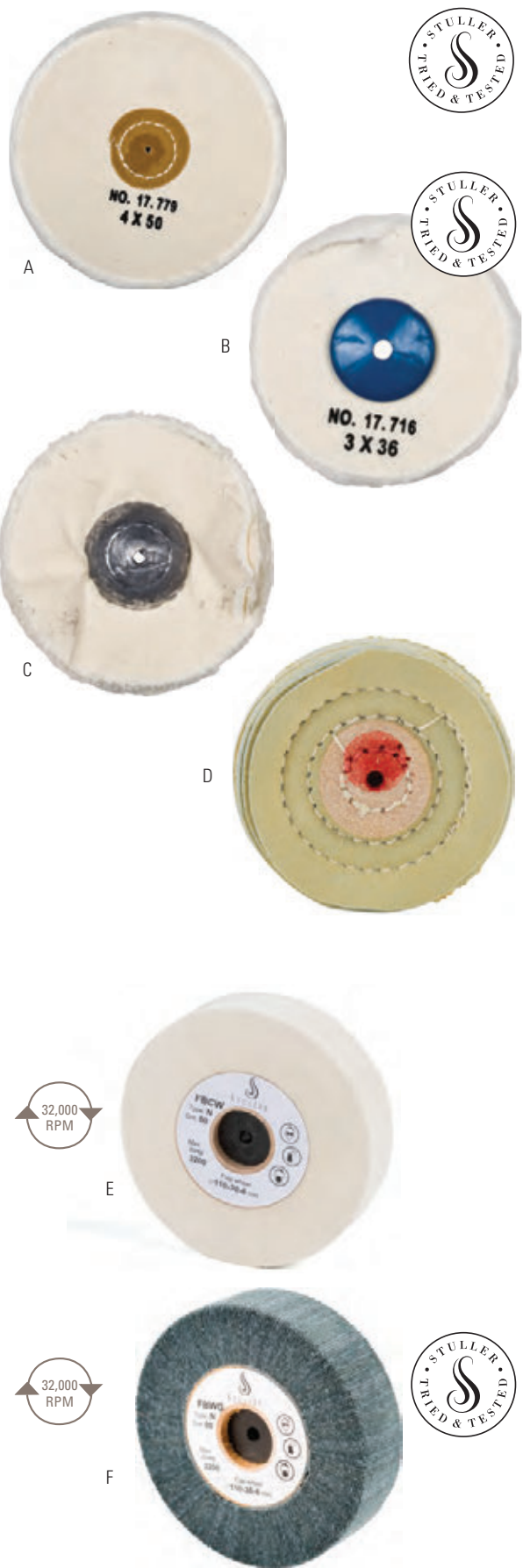



MICROFIBRA BUFFS

Comprised of an innovative paper fiber material that is designed to not obstruct polishing motor filters, produce dust, or heat objects. Ideal for use on all surfaces, these buffs have a more favorable yield compared to cotton discs and do not leave residual hairs behind. Use with suitable paste for finishing on stones and enamels. It works well on motors with turns from 2,800 (RPM) upward. It is normally dispatched through the recovery of the metals.

Order #	OD	Thickness	Rows	Ply	Center	12+	6+	1+
17-1110	7/8"				Mounted	\$2.89	\$3.06	\$3.40
17-7100	6"	5/8"	2	35	Plastic	\$11.36	\$11.86	\$12.35
17-7101	6"	13/16"	2	52	Plastic	\$14.49	\$15.12	\$15.75
17-7102	4 3/4"	5/8"	2	36	Plastic	\$9.11	\$9.50	\$9.90
17-7103	4"	7/16"	2	26	Plastic	\$7.06	\$7.47	\$8.30

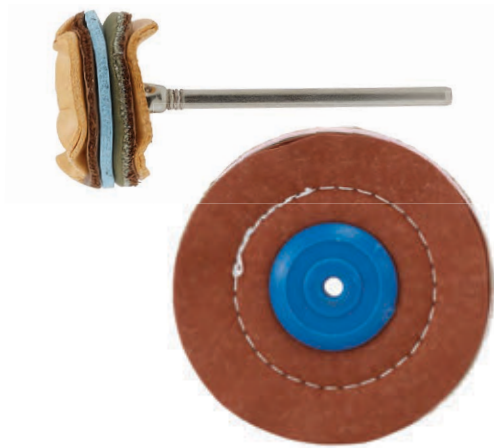

COAGULATED CLOTH BUFFS

Woven of a pure cotton impregnated with caucciú (a natural gum substance), these coagulated cloth buffs can be used to mirror polishing without creating superficial halos. Suitable for use on difficult surfaces, the buffs produce a minimal amount of dust, but after being impregnated with paste, this ceases to occur. Normally dispatched through the recovery of metals, the buffs tend to heat the object being polished.

Order #	OD	Thickness	Rows	Ply	Center	12+	6+	1+
17-1111	7/8"				Mounted	\$3.23	\$3.42	\$3.80
17-7104	4"	7/8"	1	20	Shellac	\$9.29	\$9.70	\$10.10
17-7105	6"	5/8"	2	32	Shellac	\$20.61	\$21.50	\$22.40



WHITE CLOTH BUFFS

Suitable for all types of metals. Ideal for final polishing and brilliant finish. To be used with semi-dry red paste.

Order #	OD	Thickness	Rows	Ply	Center	12+	6+	1+
17-7106	4"	7/16"	1	65	Plastic	\$9.56	\$10.13	\$11.25



CAMBRIQUE CLOTH BUFFS

Very soft cloth and very compact. Suitable for high level finishing and polishing.

Order #	OD	Thickness	Rows	Ply	Center	12+	6+	1+
17-7107	4 3/4"	5/8"	1	96	Plastic	\$22.68	\$23.66	\$24.65

WOODEN POLISHING SPINDLE

Innovative tool used to polish chains, bracelets, watch bands, and pendants. Helps the jeweler do the perfect job quickly and easily. Just place and hold the jewelry piece in the Polish It cradle while rotating the tool against the buff wheel of the polishing machine. Made of solid wood. Will not conduct heat from the rotating buff wheel.



Order #	Description	12+	6+	1+
43-0606	Wooden Polishing Spindle	\$11.68	\$12.19	\$12.70

BUFF CLEANING RAKE

Buff rakes are necessary to clean off compound buildup on buffs. The rakes should be used often to remove buildup from compounds, remove metal particles that cause draglines, and open up the buff to receive fresh polish compounds.



Order #	Description	Length	12+	6+	1+
43-0610	Buff Rake	15"	\$15.90	\$16.83	\$18.70

LEATHER STRIPS

Genuine cowhide leather strap is used for holding jewelry and rings while polishing, buffing, or grinding. Protects fingers from heat.



Order #	Description	Length	12+	6+	1+
17-0905	Leather Strips	3"	\$8.59	\$9.09	\$10.10

TUXEDO STYLE COTTON GLOVES

Presentation style gloves that work well for keeping a high polish on all jewelry.



Item	Order #	Description	12+	6+	1+
A	17-0751	Cotton Gloves (1 pair)	\$2.38	\$2.72	\$3.40



JEWELRY HANDLING GLOVES

Excellent for setting up fingerprint-free displays. Used to protect jewelry, silverware, and other items from fingerprints, spotting, and tarnishing. Used extensively in jewelry stores and manufacturing facilities.



Item	Order #	Description	Size	6+	3+	1+
B	17-0750	Heavyweight Cotton Gloves (12 pair)	Small	\$5.81	\$6.19	\$6.45
	17-0752	Lightweight Cotton Gloves (12 pair)	Large	\$7.29	\$7.78	\$8.10
	17-1020	Heavyweight Cotton Gloves (12 pair)	Medium	\$8.77	\$8.86	\$8.95



POLISHING GLOVES

This left- or right-handed glove is specially treated to polish silver, gold, and plated items. Works great to remove tarnish from silver.



Item	Order #	Description	12+	6+	1+
C	17-0749	Polishing Gloves	\$5.15	\$5.58	\$6.20



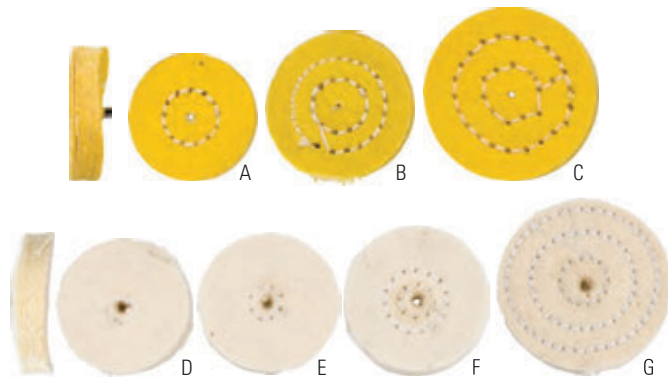

MINIATURE MUSLIN BUFFS

Use with mandrels 43-1280 or 43-1282.

Item	Order #	OD	Rows	Ply	Color	12+	6+	1+
A	17-6152	7/8"	1	16	Yellow	\$0.75	\$0.81	\$0.90
B	17-6153	1"	2	16	Yellow	\$0.79	\$0.86	\$0.95
C	17-6154	1 1/4"	2	16	Yellow	\$1.06	\$1.10	\$1.15
D	17-6150	7/8"	1	16	White	\$5.52	\$5.99	\$6.65
E	17-6151	1"	1	16	White	\$5.74	\$6.08	\$6.75
F	17-6156	1"	2	16	White	\$0.62	\$0.68	\$0.75
G	17-6157	1 1/4"	3	16	White	\$0.68	\$0.72	\$0.80

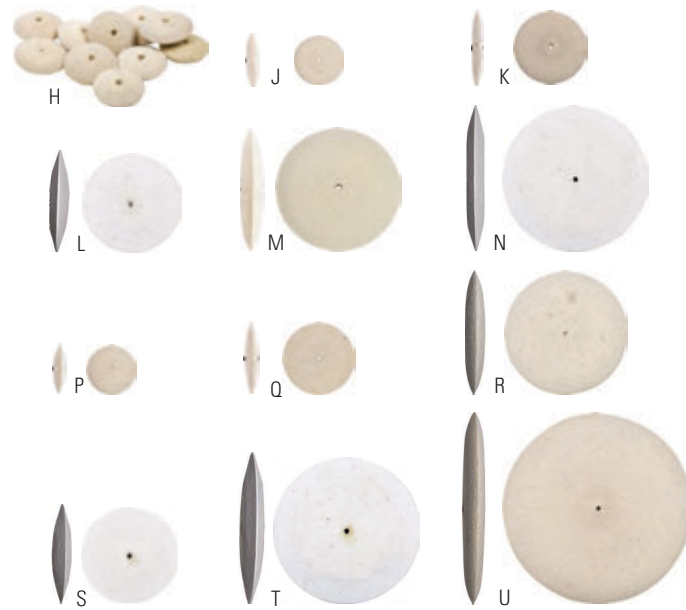

KNIFE-EDGE, SOLID FELT BUFFS

Unmounted knife-edge, hard, solid felt with tapered edges for polishing crevices. All with pinholes for tapered or screw mandrels.

Item	Order #	Description	OD	Per Pack	12+	6+	1+
H	17-4839	Hard	5/8"	10	\$6.81	\$7.10	\$7.40
J	17-4900	Hard	1"	1	\$1.06	\$1.10	\$1.15
K	17-4902	Hard	1 1/2"	1	\$1.29	\$1.34	\$1.40
L	17-4904	Hard	2"	1	\$2.07	\$2.16	\$2.25
M	17-4906	Hard	2 1/2"	1	\$3.31	\$3.46	\$3.60
N	17-4908	Hard	3"	1	\$3.40	\$3.55	\$3.70
P	17-4910	Rock-Hard	1"	1	\$1.43	\$1.49	\$1.55
Q	17-4912	Rock-Hard	1 1/2"	1	\$1.70	\$1.78	\$1.85
R	17-4914	Rock-Hard	2"	1	\$2.53	\$2.64	\$2.75
S	17-4916	Rock-Hard	2 1/2"	1	\$4.05	\$4.22	\$4.40
T	17-4918	Rock-Hard	3"	1	\$4.42	\$4.61	\$4.80
U	17-4920	Rock-Hard	4"	1	\$7.73	\$8.06	\$8.40

SQUARE-EDGE SOLID FELT WHEELS

These high-grade wheels are excellent for all-purpose polishing and buffing. All have pinhole centers. Made in the USA.



Order #	Grade	OD	Thickness	12+	6+	1+
17-4500	Soft	3"	1/2"	\$7.22	\$7.54	\$7.85
17-4501	Soft	4"	1/2"	\$9.29	\$9.70	\$10.10
17-4502	Soft	5"	1/2"	\$14.54	\$15.17	\$15.80
17-4503	Soft	6"	1/2"	\$17.53	\$18.29	\$19.05
17-4499	Medium	2 1/2"	1/2"	\$4.46	\$4.72	\$5.25
17-4505	Medium	3"	1/2"	\$8.05	\$8.40	\$8.75
17-4506	Medium	4"	1/2"	\$11.27	\$11.76	\$12.25
17-4507	Medium	5"	1/2"	\$17.39	\$18.14	\$18.90
17-4508	Medium	6"	1/2"	\$23.28	\$24.29	\$25.30
17-4510	Hard	3"	1/2"	\$9.57	\$9.98	\$10.40
17-4511	Hard	4"	1/2"	\$11.73	\$12.24	\$12.75
17-4512	Hard	5"	1/2"	\$17.39	\$18.14	\$18.90
17-4513	Hard	6"	1/2"	\$25.12	\$26.21	\$27.30
17-4514	Hard	6"	1"	\$44.39	\$46.32	\$48.25
17-4516	Rock Hard	3"	1/2"	\$12.79	\$13.34	\$13.90
17-4517	Rock Hard	4"	1/2"	\$16.05	\$16.75	\$17.45
17-4518	Rock Hard	5"	1/2"	\$20.61	\$21.50	\$22.40

MINIATURE, SOLID FELT WHEELS

These high-quality, unmounted, felt wheels are excellent for all general polishing applications. Wheels are 1/8" thick (3.18 mm) and are unmounted.

Item	Order #	Description	OD	Per Unit	12+	6+	1+
A	17-3559	Soft	1/2"	10	\$1.75	\$1.82	\$1.90
	17-3560	Soft	1/2"	100	\$13.80	\$14.40	\$15.00
	17-3639	Soft	5/8"	10	\$1.75	\$1.82	\$1.90
B	17-3640	Soft	5/8"	100	\$13.89	\$14.50	\$15.10
	17-3679	Soft	3/4"	10	\$1.75	\$1.82	\$1.90
	17-3680	Soft	3/4"	100	\$14.08	\$14.69	\$15.30
C	17-3681	Extra Soft	3/4"	100	\$11.73	\$12.24	\$12.75
	17-3769	Soft	1"	10	\$2.44	\$2.54	\$2.65
	17-3770	Soft	1"	100	\$20.33	\$21.22	\$22.10
D	17-4890	Soft	1 1/4"	Each	\$1.10	\$1.15	\$1.20
	17-3519	Hard	1/2"	10	\$2.12	\$2.21	\$2.30
	17-3520	Hard	1/2"	100	\$15.04	\$15.70	\$16.35
E	17-3599	Hard	5/8"	10	\$2.02	\$2.11	\$2.20
	17-3600	Hard	5/8"	100	\$15.32	\$15.98	\$16.65
	17-3659	Hard	3/4"	10	\$3.08	\$3.22	\$3.35
F	17-3660	Hard	3/4"	100	\$15.41	\$16.08	\$16.75
	17-3711	Hard	1"	10	\$2.44	\$2.54	\$2.65
	17-3720	Hard	1"	100	\$16.88	\$17.62	\$18.35

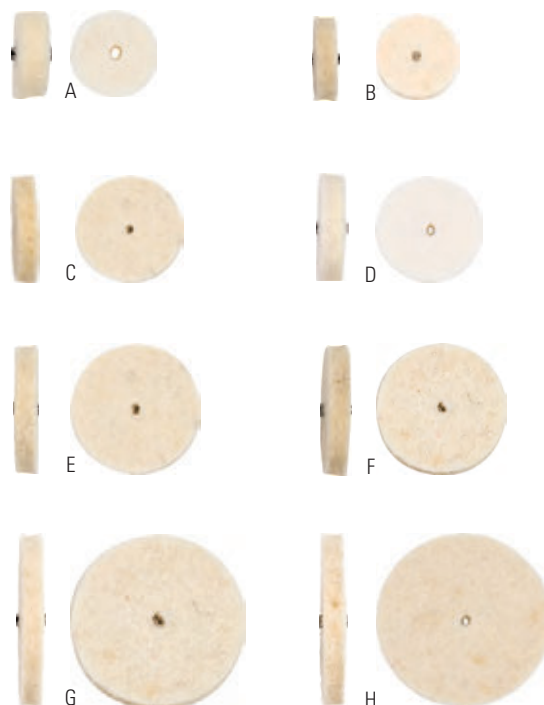

MOUNTED MIDGET BUFFS

3/32" shanks. One-inch diameter.

Item	Order #	Description	Tool Shape	12+	6+	1+
J	17-1105	Felt	Square-Edge	\$11.73	\$12.24	\$12.75
K	17-1106	Chamois	Square-Edge	\$20.61	\$21.50	\$22.40
L	17-1107	Muslin	Square-Edge	\$6.99	\$7.30	\$7.60
M	17-1108	String	Round	\$1.53	\$1.62	\$1.80
N	17-1109	String	Round	\$1.66	\$1.73	\$1.80



MOUNTED MIDGET-FELT BUFFS

3/32" shanks.



Item	Order #	Tool Shape	Per Pack	12+	6+	1+
P	17-1201	Cylinder	12	\$8.46	\$8.83	\$9.20
Q	17-1202	Round	12	\$11.73	\$12.24	\$12.75
R	17-1203	Bud	12	\$12.47	\$13.01	\$13.55
S	17-1204	Point	12	\$12.47	\$13.01	\$13.55
T	17-1207	Square	12	\$8.97	\$9.36	\$9.75



MOUNTED MIDGET BUFFS

3/32" shanks.

Item	Order #	Grade	Color	OD x Thickness	12+	6+	1+
U	11-8281	Coarse	Light Brown	7/8" x 1/4"	\$1.27	\$1.35	\$1.50
V	11-8280	Medium	Brown	7/8" x 1/4"	\$1.27	\$1.35	\$1.50
W	11-8279	Fine	Purple	7/8" x 1/4"	\$1.27	\$1.35	\$1.50
Y	11-8278	Luster Bright	Peach	7/8" x 1/4"	\$1.27	\$1.35	\$1.50





SOLID, FELT, RING BUFFS

Unmounted. Used directly on tapered spindles. Regular length.

Item	Order #	Outside Diameter	Length	12+	6+	1+
A	17-3320	9/16"	3"	\$2.08	\$2.25	\$2.50
B	17-3325	5/8"	4"	\$2.08	\$2.25	\$2.50



TAPERED, FELT-INSIDE RING BUFF

Ring buffs are mounted on wooden mandrels. Attaches to a spindle motor.

Item	Order #	Outside Diameter	Length	Taper	12+	6+	1+
C	17-3150	9/16"	3"	5/16"	\$2.57	\$2.79	\$3.10
D	17-3154	7/8"	4"	5/8"	\$2.68	\$2.84	\$3.15
E	17-3155	1"	5"	1 1/16"	\$3.74	\$4.05	\$4.50



FELT BUFF AND KNIFE-EDGE WHEEL

Felt combination buff. Mounted on wood mandrel. Has knife-edge wheel.

Item	Order #	ID x L x Taper	Wheel Diameter	12+	6+	1+
F	17-3413	3/4" x 3" x 7/16"	2"	\$5.20	\$5.42	\$5.65
G	17-3414	7/8" x 4" x 5/8"	2"	\$5.52	\$5.76	\$6.00



FELT COMBINATION BUFFS

Consists of a wheel buff and an inside-ring buff mounted on a wooden mandrel. Allows polishing of the inside and outside of rings without changing buffs.

Item	Order #	ID x L x Taper	Wheel Diameter	Wheel Thickness	12+	6+	1+
H	17-3400	3/4" x 3" x 9/16"	2"	1/2"	\$5.28	\$5.94	\$6.60
J	17-3410	7/8" x 4" x 5/8"	2"	9/16"	\$5.28	\$5.94	\$6.60
K	17-3401	5/8" x 3" x 13/16"	2 1/2"	1/2"	\$5.28	\$5.94	\$6.60



FELT BRACELET BUFF

High grade, pure solid felt, these medium density buffs are mounted on a hardwood core. Shaped to fit the larger diameters of bangles and bracelets. Use on tapered spindle polishers.

Order #	OD x Length	12+	6+	1+
17-3315	2" x 2"	\$8.05	\$8.40	\$8.75



MOUNTED MINIATURE SATIN-FINISH BUFFS

Made of synthetic fiber. Produces a satin finish on gold, silver, and other metals. Mounted on 3/32" mandrel.

Item	Order #	Grade	Diameter	Thickness	12+	6+	1+
A	17-9001	Fine	3/4"	1/4"	\$1.24	\$1.30	\$1.35
B	17-9002	Medium	3/4"	1/4"	\$1.33	\$1.39	\$1.45
C	17-9003	Fine	1"	1/4"	\$1.43	\$1.49	\$1.55
D	17-9004	Medium	1"	1/4"	\$1.52	\$1.58	\$1.65

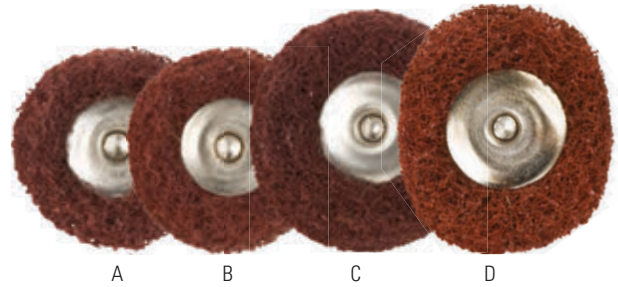

STULLER ALUMINUM-OXIDE FLAP WHEELS

The most popular item in the jewelry world. Used for every kind of satin finishing pattern, from the roughest (Grit A/Coarse) to the finest (Grit/Ultra-Fine).



Order #	Grade	OD	Thickness	Hole ID	12+	6+	1+
10-7070	Coarse	4"	1"	1/4"	\$9.61	\$10.17	\$11.30
10-7071	Medium	4"	1"	1/4"	\$9.61	\$10.17	\$11.30
10-7072	Fine	4"	1"	1/4"	\$9.61	\$10.17	\$11.30
10-7073	Extra Fine	4"	1"	1/4"	\$9.61	\$10.17	\$11.30

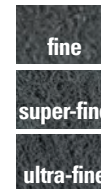
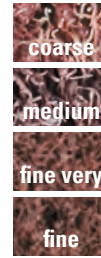

STULLER SILICONE-CARBIDE FLAP WHEELS

Order #	Grade	OD	Thickness	Hole ID	12+	6+	1+
10-7074	Fine	4"	1"	1/4"	\$9.61	\$10.17	\$11.30
10-7075	Super Fine	4"	1"	1/4"	\$9.61	\$10.17	\$11.30
10-7076	Ultra-Fine	4"	1"	1/4"	\$9.61	\$10.17	\$11.30

ALUMINUM-OXIDE FLAP WHEELS

Versatile wheels that can be used for light deburring and polishing on gold, silver, and other non-ferrous metals. Excellent for producing a satin finish. 4" (101.6 mm) diameter, 3/4" (19.1 mm) thick, and 1/4" (6.4 mm) arbor hole.

Item	Order #	Description	12+	6+	1+
E	17-8734	Coarse	\$13.69	\$14.49	\$16.10
F	17-9552	Medium	\$13.69	\$14.49	\$16.10
G	17-8732	Fine	\$14.81	\$15.46	\$16.10
H	17-9550	Extra-Fine	\$14.96	\$15.84	\$17.60



SATIN-FINISH WHEELS

Used to obtain matte finishes on metal and plastic. Abrasive granules are impregnated into the nylon fibers. 4" (101.6 mm) diameter, 3/4" (19.1 mm) thick, and 1/4" (6.4 mm) arbor hole.

Item	Order #	Grade	12+	6+	1+
J	17-8720	Coarse	\$5.43	\$5.66	\$5.90
K	17-8710	Medium	\$5.43	\$5.66	\$5.90
L	17-8700	Fine	\$4.00	\$4.18	\$4.35

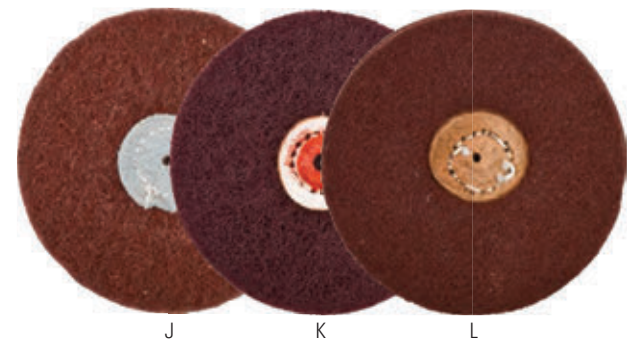



LEATHER FINGER COTS

Soft leather guard necessary for use in protecting fingers from compounds, heat, and abrasion during grinding and finishing.



Order #	Description	12+	6+	1+
47-5266	Small/Medium (Women's)	\$13.44	\$15.12	\$16.80
47-5267	Medium/Large (Men's)	\$13.44	\$15.12	\$16.80
47-5268	Thumb Size (Men's)	\$13.44	\$15.12	\$16.80



FINGER COTS

Comfortable cotton and elastic finger cots help protect your fingers as well as your skin while adding support and security when handling jewelry.



Order #	Description	12+	6+	1+
47-5269	Finger Cots	\$6.76	\$7.16	\$7.95



LEATHER FINGER GUARDS

Elastic-backed, leather finger guards are a must for polishing or grinding. Protects fingers from heat, compounds, and abrasives. Split Leather: Has a rough texture that resists cuts, abrasions, and wear, longer than grain leather.

Item	Order #	Description	Material	12+	6+	1+
A	47-5260	Open-End Finger Guard	Split Leather	\$0.78	\$0.82	\$0.85
B	47-5261	Open-End Thumb Guard	Split Leather	\$0.83	\$0.86	\$0.90
C	47-5262	Over-End Finger Guard	Split Leather	\$0.97	\$1.01	\$1.05
D	47-5263	Over-End Thumb Guard	Split Leather	\$0.97	\$1.01	\$1.05
E	47-5264	Over-End Finger Guard	Grain Leather	\$1.10	\$1.15	\$1.20
F	47-5265	Closed-End Finger Guard	Grain Leather	\$1.29	\$1.34	\$1.40

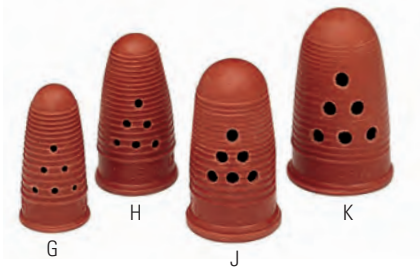

RUBBER FINGER PADS

Superior quality rubber finger pads. These pads have sure grip and are ventilated for comfort.



Item	Order #	Description	12+	6+	1+
G	69-1101	#11 Small	\$5.89	\$6.14	\$6.40
H	69-1102	#12 Medium	\$5.70	\$5.95	\$6.20
J	69-1103	#13 Large	\$5.89	\$6.14	\$6.40
K	69-1104	#14 Extra-Large	\$5.89	\$6.14	\$6.40

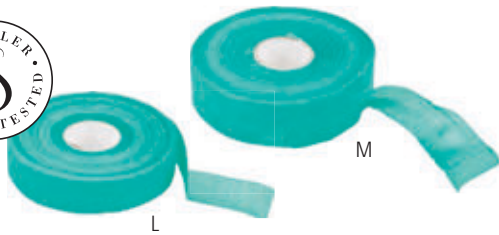

FINGER PRO TAPE

Finger Pro is the ultimate finger protection from cuts, burns, and abrasions. It is thin and tough and allows the user to handle small articles much better than conventional cots or gloves. This unique tape sticks only to itself and not to your skin.

Item	Order #	Description	W x L	12+	6+	1+
L	23-2500	Finger Tape	3/4" x 90'	\$1.75	\$1.82	\$1.90
M	23-2501	Finger Tape	1" x 90'	\$1.98	\$2.06	\$2.15

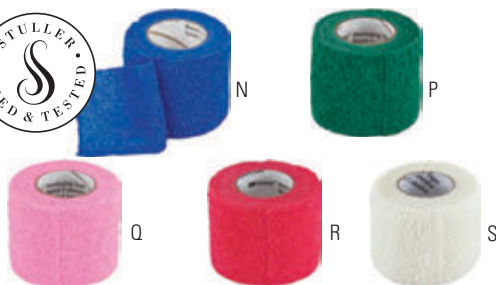

VETRAX™ TAPE

The ultimate in finger protection from cuts, burns, and abrasions. Allows user to handle small articles. Unique tape that only sticks to itself.

Item	Order #	Description	W x L	12+	6+	1+
N	23-2400	Blue	2" x 15"	\$2.07	\$2.16	\$2.25
P	23-2401	Hunter Green	2" x 15"	\$2.07	\$2.16	\$2.25
Q	23-2402	Hot Pink	2" x 15"	\$2.07	\$2.16	\$2.25
R	23-2403	Red	2" x 15"	\$2.07	\$2.16	\$2.25
S	23-2404	White	2" x 15"	\$2.07	\$2.16	\$2.25

SELVYT™ CLOTH

Lint-free jewelry cleaning cloths. SR quality.

Item	Order #	Style	W x L	6+	3+	1+
A	17-0800	O	5" x 5"	\$1.44	\$1.54	\$1.60
	17-0801	A	10" x 10"	\$5.38	\$5.74	\$5.98
	17-0802	B	14" x 14"	\$6.26	\$6.67	\$6.95
	17-0803	C	17" x 14"	\$9.14	\$9.74	\$10.15

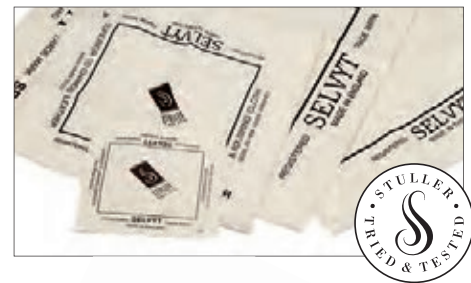

FABULUSTRE® POLISHING CLOTH

Double-cloth, one side impregnated with jeweler's rouge and the other side for final polish.

Item	Order #	Description	W x L	12+	6+	1+
B	17-0760	Polishing Cloth	9" x 11"	\$4.65	\$4.85	\$5.05



MAGIC CLOTH

Space-age cleaning cloth will revolutionize the cleaning of loose stones. The "Magic Cloth" with its specially treated microfiber is simply the best and most effective way to clean your loose stones. No lint residue. Removes dust, dirt, and fingerprints, and won't scratch.

Item	Order #	Color	W x L	12+	6+	1+
C	17-0762	Green	7" x 6"	\$2.02	\$2.11	\$2.20
D	17-0763	Blue	7" x 6"	\$2.02	\$2.11	\$2.20
E	17-0764	Gray	7" x 6"	\$2.02	\$2.11	\$2.20
F	17-0765	Maroon	7" x 6"	\$2.02	\$2.11	\$2.20



BRILLIANT POLISHING CLOTH

Newly developed chemical treatment polishers help prevent tarnish from reappearing. Polishes brass, chrome, copper, silver, and gold without the rouge mess on your hands.

Item	Order #	Color	W x L	6+	3+	1+
G	17-0770	Blue	4" x 6"	\$2.03	\$2.17	\$2.26
H	17-0775	Blue	12" x 8"	\$2.93	\$3.12	\$3.25
	17-0776	Yellow (not shown)	12" x 8"	\$3.50	\$3.65	\$3.80

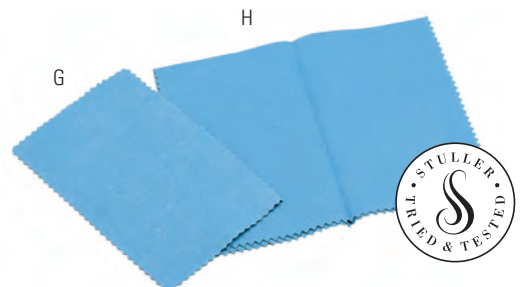

GEMBRIGHT LINTLESS CLOTH

Gembright Lintless Cloth. Microfiber for maximum softness for cleaning stones or metal surfaces. Untreated and an excellent value. Also a great resale item.

Item	Order #	Description	W x L	12+	6+	1+
J	17-0820	Lintless Cloth	9" x 10"	\$3.73	\$3.89	\$4.05



REVOLUTIONARY HIGH PERFORMANCE POLISHING CLOTH

The high performance cloth is new technology that provides ultra cleaning power because of its knitted interwoven design.

- Scratch-, smear-, streak-, and lint-free
- Easy removal of smudges, grease, dust, and polish residue
- Can be used wet or dry
- Machine washable up to 25 or 30 times
- Clean because no polishing compounds are in the cloth.

Item	Order #	Description	W x L	6+	3+	1+
K	17-1000	Polishing Cloth	12¾" x 14"	\$3.92	\$4.18	\$4.35
L	61-9424	Polishing Cloth	6" x 7"	\$2.17	\$2.30	\$2.55



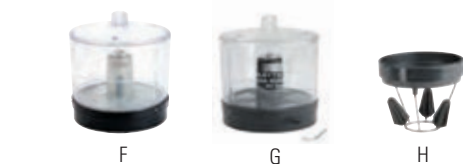
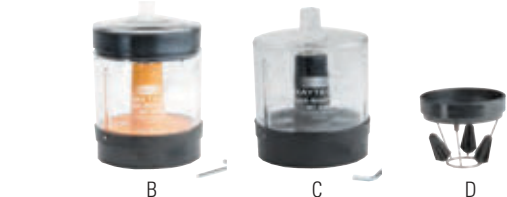

RAYTECH MAGNETIC FINISHER

Small Capacity with programmable functions and can hold 8 to 12 small rings or findings. Unit includes bowl, stainless steel pins, and tumbling soap. Unit features a green start button, red stop button, timer and speed control with forward and reverse function.

Item	Order #	Description	Ring Capacity	Pin Capacity	1+
A	47-5007	Raytech CFM 410	8-12	100	\$675.00

ACCESSORIES

B	47-5008	Dry Bowl 4" Diameter			\$165.00
C	47-5009	Wet Bowl 4" Diameter			\$159.00
D	47-5012	Parts Holder			\$55.00

RAYTECH MAGNETIC FINISHER

Holds 30 to 50 small rings or findings. Unit, also programmable, includes bowl, stainless steel pins, and tumbling soap. Unit features a green start button, red stop button, timer, and speed control with forward and reverse function.

Item	Order #	Description	Ring Capacity	Pin Capacity	1+
E	47-5021	Raytech CFM 610	30-50	200	\$1,298.00

ACCESSORIES

F	47-5022	Dry Bowl 6" Diameter			\$179.00
G	47-5023	Wet Bowl 6" Diameter			\$179.00
H	47-5024	Parts Holder			\$69.95

Only with **Raytech's Flex-System** can you utilize three types of functions. Raytech's models 410 and 610 have compatible bowls.

Change and rinse as frequently as required to keep the process clean.

Wet Burnishing Pins:

- High luster burnishing
- Edge smooth/light radiusing

Abrasive (wet): CBW bowls required

- Surface refinement
- Edge radiusing
- Uniform surface quality
- cut down

Dry Processing: CBD bowls required

- Decorative finish
- Bright, refined and uniform buff-like, high luster quality

RAYTECH FINISHING MEDIA

J. Dri-Buff Media: A corn-based media that will provide a mirror finish and can be used in our CMF dry bowls with cycles of approximately 30-40 minutes. As with the Dri-Shine VII, alternate the media between cycles to prevent overheating of the media. Note—when using Dri-Buff in the CMF-410 or CMF-610 finishers, run the machine at half speed.

K. Dri-Shine VII Media: A nut-based media that can be used as a final polish in most applications and was designed specifically for use with our CMF-410 and CMF-610 dry bowls. Fill to the media line on the bowl. Cycle times will run from 20-45 minutes depending on your application. Use approximately four to six cycles and then reactivate with our Dri-Shine VII Reactivator. Note—to prevent condensation, change the media between cycles.

L. Dri-Shine VII Reactivator: Reactivate every four to six cycles to keep the media active. Reactivator will work into the Dri-Shine VII in only a few minutes. Use ½ teaspoon of Reactivator in the CMF-410 dry bowl, and 1 teaspoon in the CMF-610 dry bowl.

Item	Order #	Description	Weight	12+	6+	1+
J	47-5015	Dri-Buff	4 lb Bucket	\$26.39	\$28.62	\$31.80
K	47-5013	Dri-Buff	5 lb Bucket	\$36.42	\$38.57	\$42.85
L	47-5014	Dri-Shine (recharger)	1 lb Bucket	\$26.39	\$28.62	\$31.80

MAGNETIC TUMBLER

Help cut down on polishing time by using one of these tumblers. Best Built tumblers polish those intricate pieces where normal polishing doesn't work. Replacement bowls are under same tumbler order number.

Features:

- Workhorse AC motor
- One-year warranty
- Direct Drive 60-minute timer
- 110 volt
- Auto shut-off
- Select models include speed control
- Heavy-duty plastic bowls

Order #	Watts	Weight	Ring Capacity	Bowl Size	1+
47-5041	15	12 lbs	1-6	3½" × 2¾"	\$249.00
47-5042	40	18 lbs	1-8	4¾" × 3½"	\$450.00
47-5043	90	22 lbs	10-22	5½" × 4¾"	\$695.00
47-5044	150	30 lbs	20-29	5¾" × 4¾"	\$820.00
47-5045	175	35 lbs	25-40	6½" × 4½"	\$995.00
47-5046	300	70 lbs	50-100	7¾" × 4½"	\$1,795.00



MAGNETIC PIN SEPARATOR

Eliminates tedious separation of parts from stainless steel media. Insert the wand into your bowl, pull the trigger to activate, and stir. The stainless steel media will attach to the wand until you release the trigger.

Order #	Description	1+
47-5058	Magnetic Pin Separator	\$123.50



STAINLESS STEEL PINS

These stainless steel pins are approximately 5mm x 0.5mm. Use with our magnetic finishers. Use with Stuller finishing soap #54-4453.

Order #	Description	1+
47-5055	Steel Pins	\$19.45





NOVA FINISHING SYSTEMS

The Nova Vibratory Finishers are specifically designed and engineered to meet the rugged demands of large production shops and small jewelers. The Nova finishers feature a welded metal base that has chemically resistant paint. Each machine has an on/off timer with a 0 to 60 minute cycle or constant. The unique, hard-mount, spring system permits maximum use of energy into amplitude or vibration and will roll steel shot. The work chamber bowl is of one-piece construction and is 5/8" thick instead of the standard 3/8" which extends the bowl life by an additional 3 to 5 years. The Nova Finisher can run wet or dry media. There is a 1/2" drain system with chokeoff clamp for wet applications. The motors operate at 1,725 RPM, 115 volt, single phase, 60Hz and are rated for 138,000 hours of service.

- A. **Nova 250 HT Motor** - 1/6 hp - Volume: 1/4" cubic feet - Liquid: 2 gallons - Capacity: 100-120 lbs. of steel media, 35-50 lbs of ceramic media 70-90 lbs of ceramic media - Bowl dimensions: 14" OD x 5" ID x 6" H
- B. **Nova 500 HT Motor** - 1/4 hp - Volume: 1/2" cubic feet - Liquid: 4 gallons - Capacity: 200-230 lbs. of steel media, 70-90 lbs of ceramic media - Dimensions: 17" OD x 6" ID x 7 1/2" H

Order #	Description	1+
47-5070	250HT Finisher	\$799.95
47-5075	500HT Finisher	\$1,242.00



ECO-MINI DRY POLISHER

Used for dry polishing with walnut shell media. Ideal for restoring a brilliant luster to tarnished jewelry. Capable of polishing gold, silver, or platinum to a high degree of machined quality. Process time: 1-4 hours. Made in Germany. Includes:

- 2 oz polishing paste
- 2.2 lb of coarse impregnated walnut shell
- 12 hour timer
- 2.2 lb of fine impregnated walnut shell

- Specifications:
- Volume: 3 liters
 - Power: 50 watts
 - Voltage: 110V (60hz)
 - Dimensions: 9" D x 13" H
 - Weight: 8 lbs

For heavy items, use the ring holder to keep heavy items suspended in media.

Order #	Description	1+
47-5100	Eco-Mini Dry Finisher	\$1,098.95



BARRELL TUMBLERS

D. Versatile, two barrel 6 lb (2.7kg) capacity tumbler uses two-3 lb long life molded rubber barrel. Ideal for small batches of jewelry. Continuous duty, fan cooled motor with overload protection.

E. Professional quality tumbler features a larger, more powerful, continuous-duty, fan-cooled motor with overload protection. Steel hexagon barrel with removable liner ensures long, efficient- and quiet operation. 15 lb capacity, with a five-year warranty on the barrel and liner.

Item	Order #	Description	1+
C	47-5160	Two Barrel Tumbler	\$169.50
D	47-5164	Heavy Duty Barrel Tumbler	\$263.85

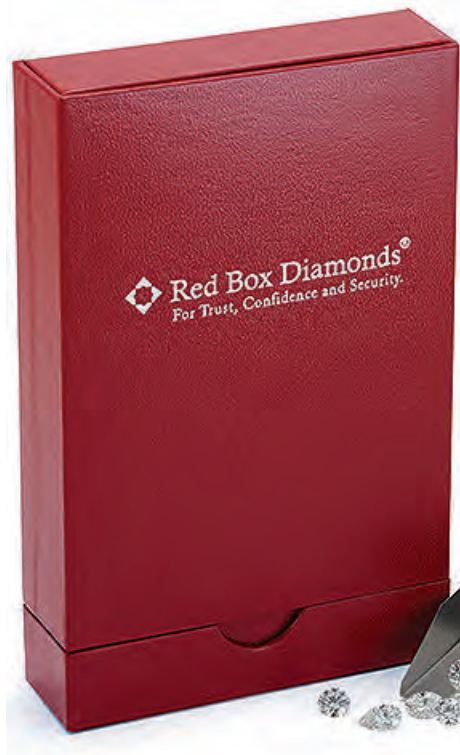

Red Box Diamonds®

Red Box Diamonds offer one-of-a-kind options ideal for your custom designs. Choose any number of shapes, qualities, report types, and price points to find the perfect match.

Red Box Diamonds® Benefits

Accurate Grading

Red Box Diamonds come with a report from an independent gemological laboratory or with a Red Box Diamond grading report. We guarantee that the Red Box Diamond grading report is accurate.*

Guaranteed Value

When your customer is ready to upgrade her Red Box Diamond, we offer a Trade-Up Program. Sell confidence to your customer that the diamond they are purchasing will hold its value over time. Your customer can trade it in for a stone of greater value and receive a credit toward their new purchase of a Red Box Diamond.**

Committed to Excellence

We are committed to selling diamonds ethically and with integrity. All Red Box Diamonds comply with the Kimberley Process, which is a system of warranties that ensure that diamonds are conflict-free.

Free Loss Protection for One Year

All Red Box Diamonds come with free loss protection against theft, loss, or mysterious disappearance for one year. Free coverage begins on the postmarked date of the registration form. There is no deductible.

Secure Identification

Each Red Box Diamond comes with the added security of a unique identification number, laser-engraved on the girdle of the stone to match the grading report. This number allows for proof positive identification.

*Learn more about diamond grading reports at Stuller.com/DiamondReportsDisclaimer. **Diamonds must be in their original condition to qualify for the Trade-Up Program



VIBRATORY TUMBLERS

Use dry only-cannot be used with Flow-Through system.

- Capacity approximately 50 rings
- 3-quart capacity
- .10 cu. ft.
- Holds 3 lbs dry shot
- Bowl size 10" x 4" high
- Ship weight 12 lbs.

Order #	Description	1+
47-5053	3qt Dry	\$249.00



VIBRATORY TUMBLERS

Three Quart: Can be used wet or dry.

- Capacity approximately 50 rings
- 3 quart capacity
- .10 cu. ft.
- Holds 8 lbs of plastic shot
- 3 lbs dry shot
- Ship weight 12 lbs
- Bowl size 10" x 4" high

Six Quart: Can be used wet or dry.

- Capacity approximately 100 rings
- 6 quart capacity
- .20 cu. ft. holds 15 lbs. of plastic shot
- 6 lbs dry shot
- Ship weight 19 lbs
- Bowl size 11½" x 6" high

Order #	Description	1+
47-5054	3qt Wet/Dry	\$349.00
47-5054	6qt Wet/Dry	\$479.00



RAYTECH VIBRATORY TUMBLERS

A. The industrial model TV-10 has light duty drive and suspension combined with a tough, cross-linked polyethylene 10 inch bowl. Has a noise reducing lid and a liquid drain. The machine is equipped for use with Raytech's FT-20 compound rinsing system. Do not run steel shot in this machine; doing so will void the warranty.

- Volume Capacity (Decimal Cu. Ft.) 0.10 (35 to 40 rings)
- Wet/Dry Operation
- Horsepower 1/15
- Drain For Recirculation Yes
- Adjustable Amplitude No
- Tilt Feature No
- Maximum Voltage Rating 115V
- Shipping Weight 12lbs
- Outside Diameter 10"

B. This machine is specifically designed for use where steel or stainless steel media processing is required although all medias can be used. It is designed with a heavy duty drive and suspension system and has adjustable amplitude. The AV-25SS has all the features of our larger machines and is a popular size for small production lots. The 14-inch bowl has a discharge port for easier unloading and a capacity of .22 cubic feet. Steel or stainless steel media capacity is 40 pounds including parts. CE

- Stationary base with adjustable vibration amplitude
- Convenient unloading plug
- 7qt. flow-thru bowl 14"Diameter x 5 1/4" Depth
- Capacity 3 cups (100 rings)
- 110V

C. For fast, easy unloading, the best choice would be Raytech's Tumble-Dump models 40, 75 or 75DC. These models incorporate all the features of the Adjusta-Vibe models with one addition: Raytech's patented Tumble-Dump tilting plate. Discharge port on TD-75DC only. CE

- Capacity 6 cups (200 rings)
- 3 gal. flow-thru bowl 16" Diameter x 7 1/2" Depth
- 110V

D. This unit incorporates a flow-through design for compound rinsing and comes with a 32 quart tank that allows up to 8 hours of compound dispensing utilizing a needle valve control for metering. The integral 0 to 6 hour timer control panel allows a tumbler to be directly plugged into the base. Recommended for jewelry and precious metals. Use with tumbler models AV-40, AV-40SS, TD-40, AV-75, AV-75DC, TD-75, TD-75DC. CE

Item	Order #	Description	1+
A	47-5032	TV10	\$269.00
B	47-5033	AV25SS	\$689.00
C	47-5034	TD40	\$1,475.00
D	47-5047	Flo Thru 75 System	\$599.00





MEDIA SCREENS

Screens for manually separating parts from media are 14½ inches in diameter x 2½ inches deep (approximately .25 cubic feet). They are also useful for separating undersize media from useable media. Made of high impact polymer with integral screen, one-piece molding eliminates problems with parts and media sticking at the joints of two-piece screens. Screens nest for storage.

Order #	Description	1+
47-5038	Set of 5 Screens with Container	\$125.00
47-5038	Set of 5 Screens	\$105.00
47-5038	Screen Container	\$30.00
47-5038	¼" Screen	\$25.00
47-5038	⅜" Screen	\$25.00
47-5038	½" Screen	\$25.00
47-5038	¾" Screen	\$25.00
47-5038	1" Screen	\$25.00



TUMBLING MEDIA

Formulated for very fine surface conditioning, low RMS finishes are commonly achieved. Plastic medias are widely used in the precision metal industries. Also due to the fine surface finishes achieved, parts are prepared for pre-plate, pre-anodize, or decorative polishing. Brown, V-Cut, Cone (medium cut), Green (light cut), and White (very fine cut). Density: 55 lbs/cu ft.

Order #	Description	1+
47-5037	¼" Brown Pyramids	\$54.00
47-5037	¼" White Pyramids	\$54.00



TUMBLING MEDIA

Porcelain balls are utilized to achieve bright finishes without the use of steel media. Because of its shape, it imparts a single point of contact resulting in a very fine finish to almost any area it can reach. Porcelain balls will not leave impingement marks that steel media produces on some other softer metals and/or flat surfaces. Their lighter weight lessens the distortion potential for lighter work and wire forms. Very popular for delicate parts, fine edge blanking and precious metal burnishing. Use with Raytech's Compound D. Mixing the sizes is recommended for good vibratory action. Please note that a break-in period of 4 to 6 hours is required. Density: 125 lbs/cu ft.

Order #	Description	1+
47-5039	2mm Porcelain Balls	\$50.00
47-5039	3mm Porcelain Balls	\$49.00
47-5039	4mm Porcelain Balls	\$47.95
47-5039	6mm Porcelain Balls	\$47.95
47-5039	1mm Porcelain Balls	\$50.00



TUMBLING MEDIA

Ceramic is the heaviest media and is also the fastest finisher. Bonded of the highest quality materials available, selected aluminum oxide abrasives produce constant quality. This durable, long-lasting media is extremely versatile for deburring machined, cast or fabricated parts. Density: 90 lbs/cu ft.

Order #	Description	1+
47-5049	Ceramic Triangle Media	\$74.50

TUMBLING MEDIA

Formulated for very fine surface conditioning, low RMS finishes are commonly achieved. Plastic medias are widely used in the precision metal industries. Also due to the fine surface finishes achieved, parts are prepared for pre-plate, pre-anodize, or decorative polishing. Brown, V-Cut, Cone (medium cut), Green (light cut), and White (very fine cut). Density: 55 lbs/cu ft.

Order #	Description	1+
47-5051	5/8" V Cut Cylinders	\$71.40
47-5051	1/2" V Cut Cylinders	\$101.00

**TUMBLING MEDIA**

Ceramic is the heaviest media and is also the fastest finisher. Bonded of the highest quality materials available, selected aluminum oxide abrasives produce constant quality. This durable, long-lasting media is extremely versatile for deburring machined, cast or fabricated parts. Density: 90 lbs/cu ft.

Order #	Description	1+
47-5052	5/16" x 3/4" Ceramic Angle Cut Cylinders 20lbs	\$72.00
47-5052	3/8" x 7/8" Angle Cut Cylinders	\$79.00

**TUMBLING MEDIA**

Ceramic is the heaviest media and is also the fastest finisher. Bonded of the highest quality materials available, selected aluminum oxide abrasives produce constant quality. This durable, long-lasting media is extremely versatile for deburring machined, cast or fabricated parts. Density: 90 lbs/cu ft.

Order #	Description	1+
47-5057	3/8" Polyhedrons	\$99.00

**TUMBLING MEDIA**

Formulated for very fine surface conditioning, low RMS finishes are commonly achieved. Plastic medias are widely used in the precision metal industries. Also due to the fine surface finishes achieved, parts are prepared for pre-plate, pre-anodize, or decorative polishing. Brown, V-Cut, Cone (medium cut), Green (light cut), and White (very fine cut). Density: 55 lbs/cu ft.

Order #	Description	1+
47-5061	3/8" XF Cones	\$115.00





Find added video content on Stuller.com.

POLYCHEM MF610 BURNISHING COMPOUND

This concentrated liquid is a mildly acidic finishing product for high-speed burnishing and tumbling and burnishing applications using magnetic needles. Contains special lubricating additives and produces a lustrous and polished finish to silver, gold, platinum, rhodium, and their alloys, as well as other precious metals. Mixing ratio: one part Polychem MF610 to 50 parts water.

Order #	Description	Weight	12+	6+	1+
54-4453	Polychem MF610	1 Gallon	\$20.68	\$23.27	\$25.85



LIQUID SHOT CONDITIONER

A non-abrasive, deburring, and cleaning compound for use with steel shot. Provides excellent rust and corrosion protection. Fully biodegradable. Concentrated, mix 1 to 2 oz per gallon.

Order #	Description	Weight	12+	6+	1+
54-4463	Liquid Shot Conditioner	1 Gallon	\$29.54	\$31.28	\$34.75



A



B



C

POLISH PASTE

Paste compounds are used to treat organic materials such as wood shapes, sawdust, corn cob, and walnut shell to create treated compound media to enhance the finishing process. Comes in 1 quart concentrate.

Item	Order #	Description	Used For	12+	6+	1+
A	47-5222	Aluminum Paste	General Purpose	\$34.13	\$35.62	\$37.10
B	47-5223	Green Paste	White Metals	\$32.98	\$34.42	\$35.85
C	47-5224	Red Paste	Yellow Metals	\$30.27	\$31.58	\$32.90



D



E

MIXED STEEL SHOT

A fast form of tumbling used to burnish metal to a mirror bright finish. Uniform in size and shape, non-abrasive, and carefully tempered to ensure long life. Carbon steel requires special storage to prevent rust and corrosion. Stainless steel shot is rust- and corrosion resistant, requiring no special storage and making it ideal for use in wet, flow-through systems. The mix consists of 3/16" (4.8mm) balls, 3/16" (4.8mm) ballcones, 1/8" x 3/8" (3.2mm x 9.5mm) pins, and 1/8" (3.2mm) diagonals for maximum coverage on a wide variety of pieces.

Item	Order #	Description	Weight	12+	6+	1+
D	47-5240	Carbon Steel	10 lb	\$103.36	\$107.86	\$112.35
E	47-5241	Stainless Steel	10 lb	\$189.84	\$198.10	\$206.35



CERAMIC FINISHING MEDIA

Ceramic media is recommended for heavy deburring or material removal on castings, machined ferrous metals, and stainless steel. Use with our #54-4453 burnishing compound.

Cylinder Wedge: General purpose cylinder wedge for aggressive deburring. Produces a dull matte finish in 10 to 20 minutes.

Cone: Angel-cut triangle good on small parts. Produces a dull finish in 15 to 30 minutes.

Item	Order #	Grade	W x L	Shape	1+
A	47-5230	Coarse	3/4" x 5/8"	Cylinder Wedge	\$39.35
B	47-5231	Medium	3/16" x 3/8"	Cone	\$33.75



A



B



C



D



E

PLASTIC FINISHING MEDIA

Plastic media is recommended for general purpose deburring and material removal on non-ferrous castings, gold, silver, brass, and copper. Plastic media comes in either a polyester or urea-bonded shape and produces a dull matte to slight luster on parts. Use with our #54-4464 burnishing compound.

Cylinder Wedge: Used for aggressive deburring. Produces a dull matte luster in 15 to 20 minutes.

Cone: Produces a smooth finish and a slight luster on parts in 30 to 60 minutes. Good for small parts.

Pyramid: Produces a smooth finish and a good luster in 60 to 180 minutes. Good for detail work.

Item	Order #	Grade	Size	Shape	1+
C	47-5235	Coarse	5/8"	Cylinder Wedge	\$36.75
D	47-5236	Medium	3/8"	Cone	\$50.25
E	47-5237	Fine	1/4"	Pyramid	\$64.45



TREATED DRY POLISHING MEDIA

This media can be used on all metals to produce an excellent mirror finish.

Item	Order #	Description	1+
F	47-5215	Corn Cob	\$43.85
G	47-5216	Walnut Shell	\$46.95



F

G



TREATED RED DRY MEDIA

This red polishing material contains soft iron oxide and is used for finishing yellow metals such as gold, brass, copper, or bronze.

Order #	Description	1+
47-5219	Corn Cob Red Media	\$39.30
47-5220	Walnut Shell Red Media	\$39.80



Ring Sizers and Stretchers



17 lbs

A

B

KAGAN RING STRETCHER/REDUCER

Reduce and enlarge wedding bands up to size 14. Reducing disc has 12 different sizes, and the mandrel has eight splines. Made in the USA.

Item	Order #	Description	Ring Sizes	W x H	1+
A	48-7520	Kagan Ring Sizer	2-14	16" x 18"	\$590.00
B	48-7535	Kagan Replacement Sleeve			\$162.00

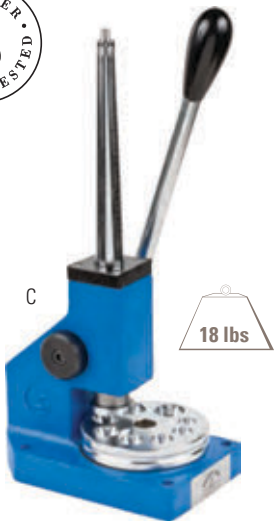

18 lbs

C



D

RING STRETCHER WITH REDUCTION WHEEL

Allows reduction or enlargement of rings. Has six-spline mandrel. Graduated in U.S. sizes. This upright style has a reversible base plate with 16 smoothly honed reduction dies that will not scratch. Allows for reducing bands by compression. Italian-made.

Item	Order #	Description	Ring Sizes	1+
C	48-7510	Stretcher with Reduction Wheel	3-15	\$395.75

RATHBURN RING STRETCHER

Perfect for stretching rings size six or larger. Simply tapping the end spreads the outer mandrel and stretches the ring. Not for use on stone set rings.

Item	Order #	Description	12+	6+	1+
D	48-7550	Ring Stretcher	\$12.71	\$13.46	\$14.95



5 lbs



GRS® RING SIZE CUTTER

This ring cutter saves time by neatly shearing a controlled amount of ring shank material. The ring remains perfectly parallel so your soldering is neat and fast. Comes with seven different size blades: 1/2, 3/4, 1, 1 1/4, 1 1/2, 1 3/4, and 2. These sizes correspond to the change in ring size. Blades change quickly and easily with no tools. Replacement blades sold separately.

Order #	Description	1+
26-4150	Ring Size Cutter	\$309.90

KAGAN RING ROLLER WITH HANDLE

Enlarges rings with set stones. Parallel rollers stretch the ring and shank without moving the stones. Sizer comes with eight dies for oval, half-round, knife-edge, and flat shanks. Can use as a mini rolling mill. Made in the USA.

Order #	Description	W x H x Depth	1+
48-7530	Kagan King Roller with Handle	4½" x 7" x 5"	\$599.00



SUPER RING BENDING TOOL

Super Ring Bending Tool is the most versatile ring bending set on the market. This bending tool makes both round and angled bends. Includes bending unit, seven dies and seven matching mandrels, steel block with screws that can be fastened to bottom of unit for vise mounting and an attractive aluminum powder coated base for easy part selection and storage. Eccentric base and handle provide high torque, requiring user to exert less effort to bend metal. Supplied with 12, 14, 16, 20 and 22mm round dies and 60° and 90° angled dies. Made in the USA.

Order #	Description	1+
48-0515	Super Ring Bending Tool	\$239.15



DURSTON RING STRETCHER/REDUCER

High precision ring stretcher/reducer featuring an eight spline mandrel and 12 polished countersunk dies. This high quality ring stretcher ensures exceptionally accurate ring sizing. Its countersunk polished steel reducing plate will reduce bands up to 12mm wide.

Order #	Description	1+
48-7512	Stretcher/Reducer	\$391.00
48-7512	Stretcher/Reducer & Bender w/dies	\$399.00



RING ENLARGER

This tool allows you to "roll out" ring shanks to enlarge stone set rings. Includes a roller for flat, wide shanks, and a series of half-round concave rollers for shanks up to 4 mm wide. Total of 16 rollers. Made in the USA.

Order #	Description	1+
48-7540	Ring Enlarger	\$68.70



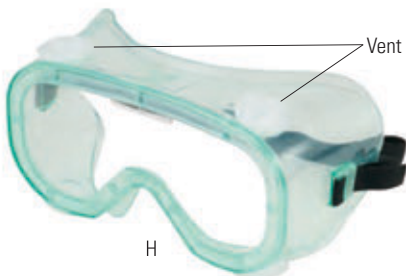

SAFETY GLASSES

A. Adjustable temples allow a comfortable, custom fit. Lenses are high-impact polycarbonate. Black nylon frame is rugged but lightweight. The DX™ Lens coating is anti-fog, anti-scratch, anti-UV, anti-static, and has excellent chemical resistance. Complies with ANSI 287.1-1989 standards. Made in the USA.

B. Engineered with an innovative molding process that actually allows the frame to serve as a shock absorber that can diffuse and deflect impact. A ventilation channel between the frame and brow bumper directs airflow under the lens to reduce moisture build-up and fogging. three-position ratchet lens inclination system with adjustable length temples allows you a custom fit.

C-D. Adjustable temples for comfortable, custom fit. High-impact, polycarbonate lens has new lens coating for anti-fog, anti-UV, anti-static, and anti-scratch. ANSI 287.1-1989 standards.

E. Single wrap around lens design with integral side shields, metal alloy temples with rubber head grips for a custom fit and a strong, yet lightweight, polycarbonate lens.

F. Wraparound metal frame offers both protection and style. Dual polycarbonate lens design provides built-in side protection and superior coverage. Spring hinge temples, soft rubber temple tips, and an adjustable saddle pad nosepiece produce a comfortable and secure fit with Uvextra™ anti-fog coating.

Item	Order #	Description	Lens Shade/Color	12+	6+	1+
A	29-0030	N-SPECS®	#5.0/Green	\$17.43	\$18.19	\$18.95
B	29-0012	Direct Safety® Kavalry	Clear	\$7.50	\$7.82	\$8.15
C	29-0010	Crews Blackjack	Clear	\$7.31	\$7.63	\$7.95
D	29-0009	UVEX Slate	Clear	\$9.57	\$9.98	\$10.40
E	29-0058	UVEX Genesis	#5.0/Green	\$16.31	\$17.68	\$19.65
F	29-0059	Crews Storm	#5.0/Green	\$8.08	\$9.09	\$10.10

ANTI-FOG GOGGLES

Clear, vinyl goggles with elastic headband for firm fit. Clear frame provides excellent front and peripheral vision. Complies with ANSI 287.1-1989 standards. Made in the USA.

Item	Order #	Description	12+	6+	1+
G	29-0040	Cover Goggles	\$3.68	\$3.84	\$4.00
H	29-0050	Fogless Lens Splash Goggles	\$4.14	\$4.32	\$4.50

FACE SHIELD WITH VISOR

Lightweight plastic provides full-face protection when polishing, soldering, or mixing investment. Comes with adjustable vinyl head band.

Item	Order #	Description	12+	6+	1+
J	29-0013	Face Shield with Visor	\$25.85	\$26.98	\$28.10
	29-0014	Visor Only	\$8.33	\$8.69	\$9.05

PLATINUM WELDING GOGGLES

Soft, vinyl body with ventilated slots. The #10 shade provides recommended eye protection for platinum melting. Lenses are impact resistant but not unbreakable. Meets ANSI 287.1 requirements.



Item	Order #	Description	12+	6+	1+
A	29-0068	Welding Goggles	\$25.85	\$26.98	\$28.10
	29-0069	#10 Lens for Platinum	\$6.50	\$6.89	\$7.65

PLATINUM SOLDERING GOGGLES

These soldering goggles provide eye protection while soldering platinum. Approved by the Platinum Guild, these goggles are available in #5, #7, or #10 shade. The #5 and #7 shades work for soldering platinum while the #10 shade is used for melting platinum. The goggles are black, lightweight plastic with adjustable ear pieces. Complies with ANSI 287.1-1989 standards.



Item	Order #	Description	12+	6+	1+
B	29-0063	#5 Shade Goggle	\$15.50	\$16.18	\$16.85
C	29-0065	#7 Shade Goggle	\$15.50	\$16.18	\$16.85
D	29-0067	#10 Shade Goggle	\$15.50	\$16.18	\$16.85

DRY BROW SWEAT BANDS

Providing a soft, cool, and sanitized way to dry your brow, these sweatbands absorb perspiration before it trickles down into the eyes or onto spectacles. Fits a wide range of safety hats and headgear, such as OptiVISOR®.



Order #	Description	12+	6+	1+
29-0032	Dry Brow Sweatbands	\$1.83	\$1.94	\$2.15

CORDED EARPLUGS

Disposable hearing protectors with convenient cord to prevent loosening. Soft, foam plug conforms and seals quickly and comfortably. Earplugs provide 29dB of sound protection. Made in the USA.



Order #	Description	Per Box	12+	6+	1+
29-0015	Corded Earplugs	Box of 10	\$3.50	\$3.65	\$3.80
29-0016	Corded Earplugs	Box of 100	\$27.88	\$29.09	\$30.30

STULLER RING CRACKER

Allows you to crack any ceramic or tungsten ring with no pain to the wearer. Very easy to use anybody can assist with the removal of these alternative metals. The kit comes with a Ring Cracker, two pairs of safety glasses and instructions. Only removes tungsten and ceramic rings.



Order #	Description	12+	6+	1+
58-2440	Ring Cracker	\$79.65	\$84.33	\$93.70

3M® RESPIRATORS

Respirator selection should first be based on the contaminant (e.g. lead, metal, fume, solvents) and the concentration of the contaminant in the workplace. Particulates (requiring filters) in the jewelry industry can include: metal fumes, silica, dust, and some acids (phosphoric and sulfuric). Gases and vapors involved in this trade may include: solvents such as toluene and xylene. Half-mask respirators protect a worker up to 10 times the PEL (OSHA's Permissible Exposure Limit), and full-face respirators up to 50 times the PEL (when quantitatively fit). The appropriate filter or carbon cartridge (or a combination of both) must be selected based on the contaminant(s) and their concentrations. After this first phase of selection is complete, there may be other criteria that influences the selection process. As an example, the use of acids should prompt consideration of appropriate eye/face protection or a full-face respirator should be considered.

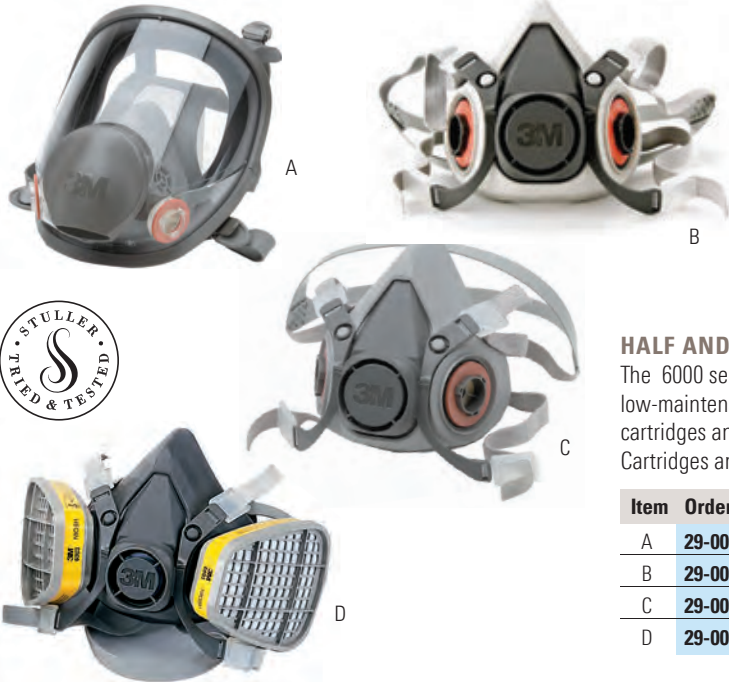

OV = NIOSH approval: Certain organic vapors
AG = NIOSH approval: Chlorine, hydrogen chloride, and sulfur dioxide or chlorine dioxide or hydrogen sulfide (escape only)
Merc = MIOSH approval: Mercury vapor or chlorine gas
OV/AG = MIOSH approval: Certain organic vapors, chlorine, hydrogen chloride, and sulfur

HALF AND FULL-FACEPIECE RESPIRATORS

The 6000 series respirators provide versatility with comfort and ease of use. These low-maintenance units are approved for use with a wide range of easily fitted cartridges and filters for particulate or gas and vapor protection NIOSH approved. Cartridges and filters sold separately.

Item	Order #	Description	Model	Size	12+	6+	1+
A	29-0006	Full-Face	6800	Medium	\$143.15	\$149.38	\$155.60
B	29-0026	Half-Face	6100	Small	\$18.06	\$19.13	\$21.25
C	29-0027	Half-Face	6200	Medium	\$18.06	\$19.13	\$21.25
D	29-0028	Half-Face	6300	Large	\$18.06	\$19.13	\$21.25



P100 ORGANIC VAPOR/ACID GAS

P-100 Filter. OV/AG. 99.97% efficient aglint solid and liquid aerosols including oil. Relief from nuisance levels of acid gas.



Item	Order #	Description	Model	12+	6+	1+
E	29-0005	P100 Organic Vapor/Acid Gas	3M60923	\$21.07	\$21.98	\$22.90



P100 PARTICULATE FILTER

P100 particulate filter fits -6000 series respirators. 99.97% efficient aglint solid and liquid aerosols including oil.



Item	Order #	Description	Model	12+	6+	1+
F	29-0007	P100 Particulate Filters	3M2091	\$8.50	\$9.00	\$10.00



MERCURY VAPOR/ACID GAS CARTRIDGE

Mercury vapor cartridge. End of service life indicator



Item	Order #	Description	Model	12+	6+	1+
G	29-0031	Mercury Vapor/Chlorine Cartridges	R6009	\$22.36	\$23.67	\$26.30



ORGANIC VAPOR/ACID CARTRIDGE

Organic vapors and acid gases. Sold in pairs. Organic vapors/cholorine/hydrogen chloride/sulfur dioxide/hydrogen flouride/hydrogen sulfide (escape only).



Item	Order #	Description	Model	12+	6+	1+
H	29-0029	Organic Vapor/Acid Gas Cartridges	3M6003	\$12.33	\$12.86	\$13.40

RESPIRATORS

Lightweight, filtering face pieces that provide greater user comfort and acceptance in a wide variety of applications and certain particulates.

RESPIRATOR SELECTION PROCESS: Under NIOSH 42 CFR 84 there are nine classes of filter comprised of three levels of minimum filter efficiency and three categories of the resistance to the effects of oil in the workplace. The three levels of filtration efficiency are 95%, 99%, and 97% (100) against the most difficult particle size to filter. The three categories of resistance to the effect of oil are N-Not resistant to oil, R-Resistant to oil, P-Oil-Proof.

MOLDEX RESPIRATORS

A. NIOSH Rating: R95. Applications: soldering, braising, torch cutting, metal pouring, polishing, and buffing.

B. NIOSH Rating: N100. Applications: welding, cutting and metal pouring.

3M® RESPIRATORS

C. NIOSH Rating: N95. Applications: grinding and sanding.

Item	Order #	Model	Size	Per Box	12+	6+	1+
A	29-0048	2740	Medium/Large	10	\$37.26	\$38.88	\$40.50
B	29-0049	2730	Medium/Large	5	\$39.38	\$41.09	\$42.80
C	29-0019	8511	Universal	10	\$22.63	\$23.62	\$24.60

3M® RESPIRATORS

D. NIOSH Rating: N95. Applications: welding, soldering, cutting, grinding and sanding.

E. NIOSH Rating: N95. Applications: welding, soldering and where metal fumes are present.

F. NIOSH Rating: N100. Applications: welding, metal pouring and work involving exposure in concentrations of up to 10X.

Item	Order #	Model	Size	Per Box	12+	6+	1+
D	29-0022	8515	Universal	10	\$31.05	\$32.40	\$33.75
E	29-0021	8212	Universal	10	\$59.66	\$62.26	\$64.85
F	29-0003	8233	Universal	Each	\$8.79	\$9.17	\$9.55

3M® RESPIRATORS

G. Applications: grinding and sanding.

H. NIOSH Rating: N95. Applications: sanding and polishing.

J. NIOSH Rating: R95. Applications: where partiles and nuisance of levels of organic vapors may be present.

Item	Order #	Model	Size	Per Box	12+	6+	1+
G	29-0017	8210	Universal	20	\$23.09	\$24.10	\$25.10
H	29-0008	8110S	Small	20	\$19.47	\$20.61	\$22.90
J	29-0004	8247	Universal	20	\$68.72	\$71.71	\$74.70

DIRECT SAFETY RESPIRATORS

K. NIOSH Rating: N95. Applications: dust irritants.

SPERIAN RESPIRATORS

L. NIOSH Rating: N95. Applications: grinding, polishing and sanding.

M. NIOSH Rating: N95. Applications: welding, soldering, braising, grinding, sanding, metal machining, polishing and buffing.

Item	Order #	Model	Size	Per Box	12+	6+	1+
K	29-0045	8610/8615	Universal	20	\$12.42	\$12.96	\$13.50
L	29-0046	14110391F	Medium/Large	20	\$23.41	\$24.43	\$25.45
M	29-0047	#2207	Medium/Large	20	\$23.63	\$25.02	\$27.80



Safety Supplies



RUBBER GLOVES



Item	Order #	Description	Length	12+	6+	1+
A	23-0043	Unlined	18"	\$23.89	\$25.29	\$28.10
B	23-0043	Lined	15"	\$13.37	\$15.28	\$19.10

DELUXE WELDERS GLOVES

Heat-resistant welding gloves feature an inner layer of aluminized Mylar® film that protects the back of the hand from radiant heat. The Mylar® film sits between a full-foam lining and a premium, side-split cowhide leather shell. Has double reinforced palm and thumb. Designed for the ultimate in comfort, wear, and protection.



Order #	Description	12+	6+	1+
22-7502	Pair Welding Gloves	\$13.66	\$14.26	\$14.85

KEVLAR PLUS SERIES GLOVES

Manufactured from 22-ounce, basket-weave Kevlar Plus. The glove material offers superior abrasion and cut resistance due to Kevlar, which is blended with nomex and fiberglass. Can be used in applications up to 800°F (426.7°C), or up to 1,000°F (537.8°C) for brief contact. Glove linings are standard heavyweight 100% wool. Features extra-wide cuff openings that allow the gloves to be dropped with a flick of the wrist in case of molten splash or excess heat buildup. 14" long.



Item	Order #	Description	12+	6+	1+
C	22-7500	Pair Wool-Lined Gloves	\$50.28	\$52.46	\$54.65

KEVLAR KNIT GLOVES

Provides exceptional cut resistance. Kevlar seamless knit gloves are constructed for long life. Sold by the pair.



Item	Order #	Description	12+	6+	1+
D	22-7506	Pair Knit Gloves	\$7.77	\$8.11	\$8.45

GLOVES

Use these gloves for clean work, assembly, light manufacturing, delicate tool and instrument applications, or anywhere extreme dexterity is required. Gloves are constructed of a seamless nylon shell dipped in nitrile coating. Gloves feature more nitrile than similar gloves, producing greater wear, improved tact, a better grip, and more cut protection. Nitrile Coated Gloves have more abrasion resistance and longer wear.



Order #	Description	12+	6+	1+
22-7511	Nitrile Coated Gloves	\$3.08	\$3.52	\$4.40

NEOPRENE GLOVES

Neoprene gloves provide superior quality and durability as well as protection against acids, caustics, oils, greases, and many solvents. Excellent all-around protection for plating. Black neoprene 14" coated gloves with knit lining. One size fits all.



Order #	Description	12+	6+	1+
22-7508	Neoprene Gloves	\$15.50	\$16.18	\$16.85

DISPOSABLE LATEX GLOVES

These high-grade, expandable latex gloves are thin to allow good finger sensitivity and excellent dexterity but are tough enough to protect your hands from dirt, grit, and harsh chemicals. Excellent to use during buffing or polishing. Gloves fit either hand.



Order #	Size	12+	6+	1+
17-0745	Small	\$13.75	\$14.35	\$14.95
17-0746	Medium	\$13.75	\$14.35	\$14.95
17-0747	Large	\$10.76	\$11.23	\$11.70

POWDER-FREE BLUE NITRILE GLOVES

Offer better tactile sensitivity, comfort, dexterity, and puncture resistant than both rubber or vinyl. These powder-free gloves are made stronger through a process called fusion bonding, which integrates synthetic polymers into the material to create a multi-layer glove or enhanced protection. Measures 4.4 mil (palm) and 4.7 mil (fingers) thickness/9½" length.



Order #	Size	12+	6+	1+
17-0846	Small	\$13.80	\$14.40	\$15.00
17-0846	Medium	\$13.80	\$14.40	\$15.00
17-0846	Large	\$11.32	\$11.81	\$12.30
17-0846	Extra Large	\$13.80	\$14.40	\$15.00

PR88 HAND PROTECTION

Excellent hand protection that will keep grease and grime from penetrating the skin. Just apply before beginning work. Washes off with soap and water.

Order #	Container Volume	12+	6+	1+
54-4462	3½ oz container	\$9.06	\$9.46	\$9.85
54-4462	1 liter container	\$27.92	\$29.14	\$30.35



ALLERGY JEWELRY SHIELD

Shields sensitive skin from jewelry irritation. Gives consumers unlimited personal choice in jewelry selection. Use on "all" skin irritating jewelry. Prevents skin discoloration. ½ ounce jar. Shipping weight 0.10 lb.



Order #	Description	12+	6+	1+
29-0035	Allergy Jewelry Shield	\$5.99	\$6.35	\$7.05



SPARKLE SPARKLE® RING SLIDE KIT

Contains no ammonia and is safe for all jewelry. Leaves no residue. Non-toxic. Non-abrasive. Odor free. Kit contains 12 bottles of Ring Slide and 3 samples of delicate, platinum, and silver jewelry cleaners.

Order #	Description	12+	6+	1+
54-4102	Ring Slide Kit	\$43.46	\$44.96	\$49.95





LEATHER WELDING APRON

Leather welding aprons are made of side-split leather and sewn together with Kevlar® thread for extra strength. The apron features a comfortable strap assembly with a quick release buckle. Comes with a two-compartment chest pocket.

Item	Order #	W × L	12+	6+	1+
A	47-3067	24" × 36"	\$28.98	\$30.24	\$31.50

NEOPRENE PLATING APRON

Durable neoprene apron designed to protect against chemical spills during plating and other applications.

Item	Order #	W × L	12+	6+	1+
B	47-3068	36" × 43"	\$18.40	\$19.20	\$20.00

DENIM APRON

Heavy-duty, washable, denim work apron. Can be burned to reclaim precious metals. Note: Color of apron may vary from light to dark blue to black.

Item	Order #	W × L	12+	6+	1+
C	47-3060	28" × 36"	\$8.22	\$8.91	\$9.90

FIRE RETARDANT APRON

Designed for the working jeweler by a working jeweler with 30 years experience. The apron material is a highly burn-resistant fabric. When hot metal is dropped on it, it leaves a barely noticeable scorch mark. It's a smooth fabric that will not lose its fire-retardant qualities even after many launderings. The top of the apron was designed to be wider, to protect more of the neck and chest, and has an adjustable neck strap that won't get stuck in long hair, as velcro will. The tie straps are long to wrap around and tie in front. The apron is 36" long to cover the lap adequately when sitting, and has a little flap at the bottom to catch runaway parts or metal filings falling into the apron.

Item	Order #	Length	12+	6+	1+
D	47-3065	38"	\$27.83	\$29.04	\$30.25



B



C



D

BRADLEY® FAUCET-MOUNTED EYE WASH

Mount this eye wash to both standard and gooseneck faucets. No special plumbing is required. Integral flow control assures a steady flow of water under varying water supply conditions. Unit is constructed of chrome-plated brass and comes standard with an adapter, diverter, twin sprayheads and pop-off plastic dust caps.

Note: To eliminate the risk of scalding eyes during use, it is recommended that the hot water supply to the faucet be disconnected or that tempered water be provided.



Order #	Description	1+
29-0101	Faucet-Mounted Eye Wash	\$71.75

EYE-WASH-STATION VISI-SIGNS SIGN

Offering 180° visibility, this three-dimensional mounted design projects 3½" out from the wall at a 45° angle, making your message seen from all sides. The 5¾" x 8¾" sign is constructed of 0.125 acrylic with pre-drilled mounting holes.



Order #	Description	1+
29-0102	Faucet-Mounted Eye Wash	\$21.00

EYE WASH VINYL STICKER

Let people know where to go in an emergency by placing this large sticker next to your eye wash station.



Order #	Description	W x L	12+	6+	1+
29-0103	Eye Wash Vinyl Sticker	10" x 7"	\$6.25	\$6.62	\$7.35

FIRST AID KIT

Be prepared! New first aid kits treat wounds and save lives. Discover the best value in first aid kits in this new Northern Kit that lets you set up a first aid station instantly, anywhere. Premium quality contents treat up to 25 people. Six partitioned areas keep contents organized. Features convenient molded carry handle.



Order #	Description	1+
29-0100	First Aid Kit	\$23.65



STULLER® PREMIUM SWISS SAW BLADES
 Genuine, premium Swiss-made saw blades made to our exacting standards.

Note: 5/0 is smallest size, #5 is largest.



Sold by the gross. (144 per unit)

Order #	Blade Size	Per Unit	12+	6+	1+
49-4200	5/0	Gross	\$18.66	\$19.76	\$21.95
49-4201	4/0	Gross	\$18.66	\$19.76	\$21.95
49-4202	3/0	Gross	\$18.66	\$19.76	\$21.95
49-4203	2/0	Gross	\$18.66	\$19.76	\$21.95
49-4204	1/0	Gross	\$18.66	\$19.76	\$21.95
49-4205	1	Gross	\$18.66	\$19.76	\$21.95
49-4206	#2	Gross	\$18.66	\$19.76	\$21.95
49-4207	#3	Gross	\$18.66	\$19.76	\$21.95
49-4208	#4	Gross	\$18.66	\$19.76	\$21.95
49-4209	#5	Gross	\$18.66	\$19.76	\$21.95

Sold by the dozen. (12 per unit)

Order #	Blade Size	Per Unit	12+	6+	1+
50-4200	5/0	Dozen	\$2.72	\$2.88	\$3.20
50-4201	4/0	Dozen	\$2.72	\$2.88	\$3.20
50-4202	3/0	Dozen	\$2.72	\$2.88	\$3.20
50-4203	2/0	Dozen	\$2.72	\$2.88	\$3.20
50-4204	1/0	Dozen	\$2.72	\$2.88	\$3.20
50-4205	1	Dozen	\$2.72	\$2.88	\$3.20
50-4206	2	Dozen	\$2.72	\$2.88	\$3.20
50-4207	3	Dozen	\$2.72	\$2.88	\$3.20
50-4208	4	Dozen	\$2.72	\$2.88	\$3.20
50-4209	5	Dozen	\$2.72	\$2.88	\$3.20



PIKE® GOLD SAW BLADES
 Tried and tested at Stuller. Premium Swiss-made saw blades.

Note: 8/0 is smallest size, #14 is largest.



Sold by the gross. (144 per unit)

Order #	Blade Size	Per Unit	12+	6+	1+
49-4080	8/0	Gross	\$25.20	\$26.69	\$29.65
49-4070	7/0	Gross	\$23.33	\$24.71	\$27.45
49-4060	6/0	Gross	\$21.46	\$22.73	\$25.25
49-4050	5/0	Gross	\$20.53	\$21.74	\$24.15
49-4040	4/0	Gross	\$18.66	\$19.76	\$21.95
49-4030	3/0	Gross	\$16.79	\$17.77	\$19.75
49-4010	1/0	Gross	\$16.79	\$17.77	\$19.75
49-4001	1	Gross	\$16.79	\$17.77	\$19.75
49-4002	2	Gross	\$16.79	\$17.77	\$19.75
49-4003	3	Gross	\$16.79	\$17.77	\$19.75
49-4004	4	Gross	\$16.79	\$17.77	\$19.75
49-4005	5	Gross	\$20.53	\$21.74	\$24.15
49-4006	6	Gross	\$21.46	\$22.73	\$25.25
49-4008	8	Gross	\$24.27	\$25.70	\$28.55
49-4100	10	Gross	\$26.56	\$28.13	\$31.25
49-4120	12	Gross	\$31.28	\$33.12	\$36.80
49-4140	14	Gross	\$34.09	\$36.09	\$40.10

Sold by the Dozen (12 per unit)

Order #	Blade Size	Per Unit	12+	6+	1+
50-4080	8/0	Dozen	\$3.74	\$3.96	\$4.40
50-4070	7/0	Dozen	\$3.74	\$3.96	\$4.40
50-4060	6/0	Dozen	\$3.57	\$3.78	\$4.20
50-4050	5/0	Dozen	\$3.40	\$3.60	\$4.00
50-4040	4/0	Dozen	\$2.72	\$2.88	\$3.20
50-4030	3/0	Dozen	\$2.81	\$2.97	\$3.30

Order #	Blade Size	Per Unit	12+	6+	1+
50-4020	2/0	Dozen	\$2.81	\$2.97	\$3.30
50-4010	0	Dozen	\$2.48	\$2.63	\$2.92
50-4001	#1	Dozen	\$2.81	\$2.97	\$3.30
50-4002	#2	Dozen	\$2.81	\$2.97	\$3.30
50-4003	#3	Dozen	\$2.81	\$2.97	\$3.30
50-4004	#4	Dozen	\$2.81	\$2.97	\$3.30

Order #	Blade Size	Per Unit	12+	6+	1+
50-4005	#5	Dozen	\$3.06	\$3.24	\$3.60
50-4006	6	Dozen	\$3.40	\$3.60	\$4.00
50-4008	#8	Dozen	\$3.57	\$3.78	\$4.20
50-4100	#10	Dozen	\$4.34	\$4.59	\$5.10
50-4120	12	Dozen	\$4.68	\$4.95	\$5.50
50-4140	#14	Dozen	\$5.06	\$5.36	\$5.95

Sold by the gross. (144 per unit)

Order #	Blade Size	Per Unit	12+	6+	1+
49-4220	4/0	Gross	\$21.89	\$23.18	\$25.75
49-4221	3/0	Gross	\$20.19	\$21.38	\$23.75
49-4222	2/0	Gross	\$20.19	\$21.38	\$23.75
49-4223	1/0	Gross	\$20.19	\$21.38	\$23.75
49-4224	1	Gross	\$20.19	\$21.38	\$23.75
49-4225	2	Gross	\$20.19	\$21.38	\$23.75
49-4226	3	Gross	\$20.19	\$21.38	\$23.75
49-4227	4	Gross	\$20.19	\$21.38	\$23.75

Sold by the dozen. (12 per unit)

Order #	Blade Size	Per Unit	12+	6+	1+
50-4220	4/0	Dozen	\$3.49	\$3.69	\$4.10
50-4221	3/0	Dozen	\$3.49	\$3.69	\$4.10
50-4222	2/0	Dozen	\$3.49	\$3.69	\$4.10
50-4223	1/0	Dozen	\$3.49	\$3.69	\$4.10
50-4224	1	Dozen	\$3.49	\$3.69	\$4.10
50-4225	2	Dozen	\$3.49	\$3.69	\$4.10
50-4226	3	Dozen	\$3.49	\$3.69	\$4.10
50-4227	4	Dozen	\$3.49	\$3.69	\$4.10

PIKE® PLATINUM SAW BLADES

This saw blade was specially designed to offer incomparable resistance to wear when cutting platinum, stainless steel, and all hard metals. It allows for a clean, precise cut, requiring a minimum of effort and providing considerably improved sawing comfort. The filed teeth guarantee a cutting capacity unequalled by any other process with a special, high quality steel. Exclusive heat processes endow our blades with a tenacity and flexibility without comparison.

Note: 4/0 is smallest size, #4 is largest.



Sold by the gross. (144 per unit)

Order #	Blade Size	Per Unit	12+	6+	1+
49-1000	8/0	Gross	\$27.07	\$28.67	\$31.85
49-1001	7/0	Gross	\$26.14	\$27.68	\$30.75
49-1002	6/0	Gross	\$23.33	\$24.71	\$27.45
49-1003	5/0	Gross	\$22.40	\$23.72	\$26.35
49-1004	4/0	Gross	\$20.53	\$21.74	\$24.15
49-1005	3/0	Gross	\$18.66	\$19.76	\$21.95
49-1006	2/0	Gross	\$18.66	\$19.76	\$21.95
49-1007	1/0	Gross	\$18.66	\$19.76	\$21.95
49-1008	#1	Gross	\$18.66	\$19.76	\$21.95
49-1010	#2	Gross	\$18.66	\$19.76	\$21.95
49-1011	#3	Gross	\$18.66	\$19.76	\$21.95
49-1012	#4	Gross	\$18.66	\$19.76	\$21.95
49-1013	#5	Gross	\$20.53	\$21.74	\$24.15
49-1014	#6	Gross	\$22.40	\$23.72	\$26.35
49-1015	#7	Gross	\$26.78	\$28.35	\$31.50
49-1016	#8	Gross	\$27.84	\$29.48	\$32.75
49-1018	#10	Gross	\$29.33	\$31.05	\$34.50
49-1020	#12	Gross	\$38.67	\$40.95	\$45.50
49-1022	#14	Gross	\$42.46	\$44.96	\$49.95

HERKULES® "WHITE LABEL" SAW BLADES

Used to cut metal, bone, pearl, and other hard material. Easier to turn corners and follow curves due to round backs.

Note: 8/0 is smallest size, #14 is largest.



Sold by the dozen. (12 per unit)

Order #	Blade Size	Per Unit	12+	6+	1+
50-1000	8/0	Dozen	\$3.83	\$4.05	\$4.50
50-1001	7/0	Dozen	\$3.83	\$4.05	\$4.50
50-1002	6/0	Dozen	\$3.61	\$3.83	\$4.25
50-1003	5/0	Dozen	\$3.44	\$3.65	\$4.05
50-1004	4/0	Dozen	\$3.44	\$3.65	\$4.05
50-1005	3/0	Dozen	\$3.15	\$3.33	\$3.70
50-1006	2/0	Dozen	\$3.15	\$3.33	\$3.70

Order #	Blade Size	Per Unit	12+	6+	1+
50-1007	1/0	Dozen	\$3.15	\$3.33	\$3.70
50-1008	#1	Dozen	\$3.15	\$3.33	\$3.70
50-1010	#2	144	\$3.15	\$3.33	\$3.70
50-1011	#3	144	\$3.15	\$3.33	\$3.70
50-1012	#4	144	\$3.15	\$3.33	\$3.70
50-1013	#5	144	\$3.44	\$3.65	\$4.05
50-1014	#6	144	\$3.44	\$3.65	\$4.05

Order #	Blade Size	Per Unit	12+	6+	1+
50-1015	#7	Dozen	\$3.61	\$3.83	\$4.25
50-1016	#8	144	\$3.83	\$4.05	\$4.50
50-1018	#10	144	\$4.21	\$4.46	\$4.95
50-1020	#12	144	\$4.68	\$4.95	\$5.50
50-1022	#14	144	\$5.74	\$6.08	\$6.75

YELLOW DAGGER SAW BLADES

Swiss-made, these sawblades provide great performance not normally seen in this price range.

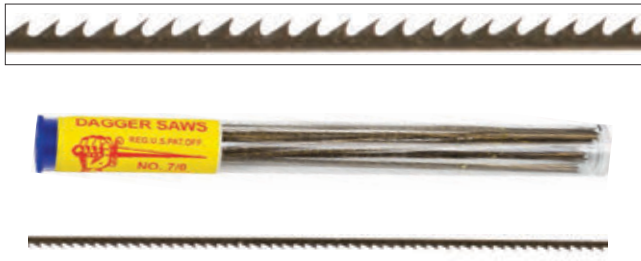

Sold by the gross. (144 per unit)

Order #	Blade Size	Per Unit	12+	6+	1+
49-6000	8/0	144	\$23.33	\$24.71	\$27.45
49-6001	7/0	144	\$21.46	\$22.73	\$25.25
49-6002	6/0	144	\$19.59	\$20.75	\$23.05
49-6003	5/0	144	\$18.66	\$19.76	\$21.95
49-6004	4/0	144	\$16.79	\$17.77	\$19.75
49-6005	3/0	144	\$15.85	\$16.79	\$18.65
49-6006	2/0	144	\$15.85	\$16.79	\$18.65
49-6007	1/0	144	\$15.85	\$16.79	\$18.65
49-6008	#1	144	\$15.85	\$16.79	\$18.65
49-6010	#2	144	\$15.85	\$16.79	\$18.65
49-6011	#3	144	\$15.85	\$16.79	\$18.65
49-6012	#4	144	\$15.85	\$16.79	\$18.65
49-6013	#5	144	\$18.66	\$19.76	\$21.95
49-6014	#6	144	\$19.59	\$20.75	\$23.05
49-6016	#8	144	\$22.40	\$23.72	\$26.35
49-6018	#10	144	\$32.34	\$34.24	\$38.05

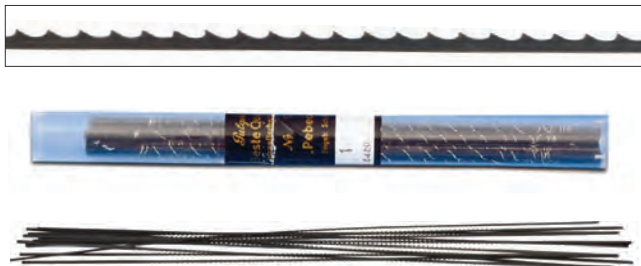

SKIP-A-TOOTH SAW BLADES

These blades are designed for wax cutting. Every other tooth is eliminated, which provides smooth cutting and non-loading action.

Sold by the gross. (144 per unit)

Order #	Blade Size	Per Unit	12+	6+	1+
49-3008	1	Gross	\$2.76	\$2.93	\$3.25



SPIRAL SAW BLADES

Used to cut rubber, plastic, wax, and plaster. Cut in any direction.

Sold by the dozen. (12 per unit)

Item	Order #	Grit	Grade	12+	6+	1+
A	49-3002	#2	Dozen	\$3.23	\$3.42	\$3.80
B	49-3003	#3	Dozen	\$3.23	\$3.42	\$3.80
C	49-3004	#4	Dozen	\$3.23	\$3.42	\$3.80
D	49-3006	#6	Dozen	\$3.23	\$3.42	\$3.80



DIAMOND SAW BLADES

We offer you another quality engineered product—our diamond-coated saw blades. Made by electroplating diamond particles onto piano wire, our diamond blades are the best quality available at prices well below the competition. Our manufacturer offers a generous supply of diamond for long life and quick cutting. Blades come individually packaged and are 5 3/8" long to fit existing saw frames. Great for glass, ceramic, and stones. Sold each.



Item	Order #	Grit	Grade	12+	6+	1+
E	49-0995	60	Coarse	\$8.41	\$8.91	\$9.90
F	49-0996	100	Medium	\$8.41	\$8.91	\$9.90
G	49-0997	120	Medium	\$8.41	\$8.91	\$9.90
H	49-0998	140	Fine	\$8.41	\$8.91	\$9.90

BACK SAW FOR METALS

Reinforced hardened steel blade with contoured wooden handle. Fine tooth back saw blade is excellent for cutting metal rods and tubing. Also useful for cross cutting, trimming, and notching light metals. Made in the USA.

Order #	Overall Length	Blade Length	12+	6+	1+
49-4300	9½"	5"	\$5.61	\$5.94	\$6.60

**PRECISION JOINT CUTTER**

Precision-machined joint cutter provides accurate 45° and 90° cuts on sheet, wire, and tubing. Easily secures in a vise for cutting or can be held by hand. Made of high carbon tool steel. Nine grooves are designed to hold a wide range of wire and tubing.

Order #	Description	W x L x D	12+	6+	1+
25-1370	Tube Cutter	1⅞" x 2" x ⅜"	\$100.77	\$106.70	\$118.55

**TUBE CUTTER JIG**

Reinforced hardened steel blade with contoured wooden handle. Fine tooth back saw blade is excellent for cutting metal rods and tubing. Also useful for cross cutting, trimming, and notching light metals. Holds tubing up to 6mm round or 7.5mm square. Made in the USA.

Item	Order #	Description	12+	6+	1+
A	58-2462	Tube Cutter Jig Economy	\$22.10	\$23.40	\$26.00
B	58-2465	Tube Holder	\$36.51	\$38.66	\$42.95

**TUBE CUTTER**

Tube cutter with four angles—30, 45, 60, and 90°. The cutter is hardened to HRC 45 with a removable handle so that it can be mounted in a vise. The thumb lock ensures a good grip on the material being cut and the adjustable slide/stop can be set with the lock screw, making repeated length of cuts easy. A deep V groove holds the material firmly in place.

Order #	Description	12+	6+	1+
58-2470	Tube Cutter	\$102.00	\$108.00	\$120.00

**MASTER SIZING VISE COMPLETE SET**

The main features of this vise include built-in measuring guide, rubber covered cutting posts, locking posts, and filing and sanding blocks. Comes with an instructional DVD.

Order #	Description	12+	6+	1+
26-4197	Sizing Vise	\$52.70	\$55.80	\$62.00



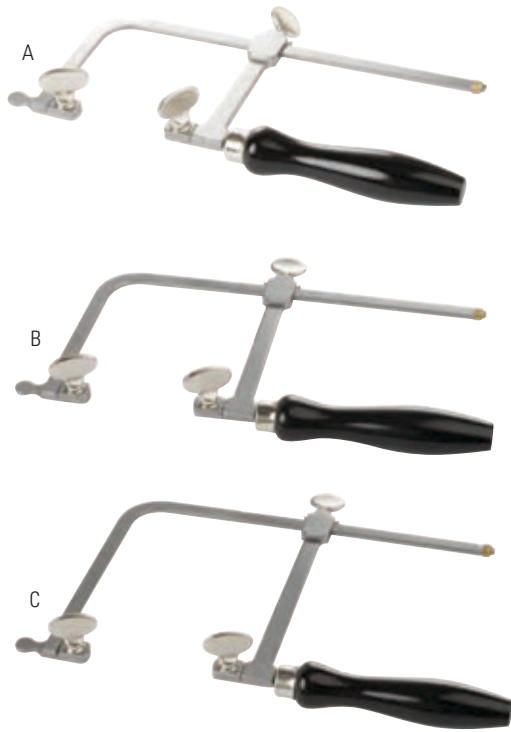

ADJUSTABLE SAW FRAMES

For use with piercing, flat, and spiral saw blades. Serrated clamps hold blades firmly. Strongly constructed with flat steel frames, hardwood handles, and thumb-screw locking devices. Most common depth is 2¼" (57mm) while others are for use when greater cutting depth is required.

Item	Order #	Description	Blade Size	12+	6+	1+
A	49-7230	Frame	3"	\$8.07	\$8.55	\$9.50
B	49-7235	Frame	4"	\$8.07	\$8.55	\$9.50
C	49-7240	Frame	5"	\$10.84	\$11.48	\$12.75

REPLACEMENT PARTS

49-7245	Wing-Screw (Holds Blades)	\$1.66	\$1.76	\$1.95
49-7246	Blade Block-Nut Pad-Washer & Wing-Nut	\$6.33	\$6.71	\$7.45
49-7247	Wing-Nut (Tightens Blade)	\$1.66	\$1.76	\$1.95
49-7248	Washer (Holds Blade)	\$1.66	\$1.76	\$1.95
49-7249	Blades Pad	\$3.27	\$3.47	\$3.85
49-7250	Wing-Screw (Holds Frame)	\$1.66	\$1.76	\$1.95
49-7251	Saw Handle	\$1.66	\$1.76	\$1.95

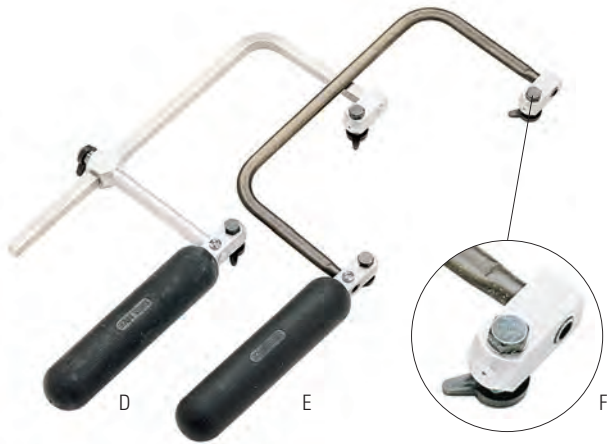

SWISS SAW FRAMES

Revolutionary new design in two lightweight, perfectly balanced saw frames. Ergonomic handles reduce fatigue and provide dexterity. Patented blade-lock design eases blade insertion, maintains perfect alignment, and eliminates wobble. This helps reduce blade loss during use. Set screws can be used on either left or right side. Easy blade insertion. Genuine Swiss-made.

Item	Order #	Description	Blade Size	12+	6+	1+
D	49-7200	Adjustable Frame	2¾"	\$13.90	\$14.72	\$16.35
E	49-7220	Fixed Frame	2¾"	\$13.90	\$14.72	\$16.35
F	49-7221	Replacement Screw		\$4.63	\$4.91	\$5.45



MINI SAW FRAME

These handy mini frames provide control for delicate operations such as gem cutting or making relief cuts on prongs that have been partially folded over stones. Their small size and light weight give the handler a better feel for what is being cut. The frames support standard blades or your broken blades if they break long enough. To insert a new blade, spring the saw slightly with your hand, or push one end against your bench. These frames can also be used with abrasive film cut to the proper length.

Order #	Description	Per Pack	12+	6+	1+
49-7213	Mini Saw Frame Kit	Set of 3	\$21.25	\$22.50	\$25.00
49-7210	Red Saw Frame	Each	\$8.46	\$8.96	\$9.95
49-7211	Blue Saw Frame	Each	\$8.46	\$8.96	\$9.95
49-7212	Yellow Saw Frame	Each	\$8.46	\$8.96	\$9.95

Sawing Practices

The jeweler's sawblade is mounted in the saw frame, under tension, with the teeth pointing downward toward the handle. The simplest way to set the tension for the blade is to adjust the length of the frame so that one end of the blade is set to the bottom of the clamp and the end of the blade is centered on the thumb-screw of the other clamp. This will allow the frame to be sprung inward from ¼" to ½" to set the proper tension on the blade. Smaller sized blades will require less tension than the larger sizes.

There are two main types of sawing action, severing and contour sawing (this includes piercing). Severing is the process of cutting a piece off or separating parts (such as when sizing a ring) in a straight line. Flat sawblades are the best choice for this process because they generally track straighter due to their design. For contour cutting, piercing sawblades are preferred. In choosing the proper size saw blade for the most efficient cutting, the thickness of the material to be cut should be taken into consideration.

Ideally, there should always be between 3 and 5 teeth in contact with the thickness of the metal. If less than 3 teeth are in contact, the cut becomes ragged and the blade has a tendency to grab. If more than 5 teeth contact the metal, the cutting process is unnecessarily slowed. Sawing is generally done with the blade at a right angle to the work. This is especially important for contour cutting. For cutting straight lines, the blade can be tilted ever-so-slightly forward (5° to 15°) to aid in tracking. Although not required, lubricating the blade prior to and during the sawing process will extend the blade life as well as enhance the cutting action.



1mm = 0.0400 inch

Size	Piercing Saw Blades		Drill Size	Flat Saw Blades	
	Thickness	Width		Thickness	Width
8/0	0.0063	0.0126	80	–	–
7/0	0.0067	0.0130	80	–	–
6/0	0.0070	0.0140	79	–	–
5/0	0.0080	0.0157	78	–	–
4/0	0.0086	0.0175	77	–	–
3/0	0.0095	0.0190	76	–	–
2/0	0.0130	0.0204	75	–	–
1/0	0.0110	0.0220	75	–	–
0	0.0110	0.0230	73	–	–
1	0.0120	0.0240	74	0.0070	0.0290
2	0.0134	0.0276	70	0.0080	0.0340
3	0.0140	0.0290	70	0.0080	0.0370
4	0.0150	0.0307	68	0.0080	0.0430
5	0.0158	0.0331	65	0.0080	0.0510
6	0.0173	0.0370	58	0.0080	0.050
7	0.0189	0.0400	56	0.0080	0.0570
8	0.0197	0.0400	55	0.0086	0.0750
9	–	–	–	0.0086	0.0830
10	0.0215	0.0510	51	0.0086	0.0950
11	–	–	–	0.0086	0.1060
12	0.0236	0.0650	51	0.095	0.1180
14	0.0236	0.0690	50	–	–

A&D EVEREST SERIES

- Gold and precious stones scales
- Multiple weighing units: (carat, gram, troy ounce, pennyweight, pound, ounce, grain, & Tael)
- Large LCD display (16mm height) with backlight
- Control zero, mode selection, and data output with standard RS-232C
- Counting function with Automatic Counting Accuracy Improvement
- Standard comparator function--HI/OK/LO annunciator
- Full digital calibration with optional user definable mass setting
- Conformity to GLP with I.D. and serial number outputs
- Auto power off
- Portable compact size, lightweight, rugged body
- Sealed key panel protection against dust and spills
- Low profile and small footprint for minimal space requirement
- Optional battery pack
- Overload protection
- Underhook weighing
- Security ring to prevent theft
- Stainless steel weighing pan



Not Canada Legal

Item	Order #	Model	Pan Size	Trade Legal	1+
A	51-4068	EK-610J	4.3" Round	Y*	\$357.59
B	51-4072	EK/EW-I	5.2" x 6.7"	Y	\$299.00
	51-4069	EK-6100J	5.2" x 6.7"	Y*	\$948.70

*NTEP Approval Legal-For-Trade is legal up to the first decimal point.

Model	Carat	Gram	Troy Ounce	Pennyweight	Pound	Grain
EK-610j	3000 x 0.1	600 x 0.01	19.29 x 0.001	385.81 x 0.01	1.2338 x 0.0001	9259.4 x 0.2
EK-1200i	6000 x 0.5	1200 x 0.1	38.58 x 0.005	771.6 x 0.1	2.6455 x 0.0005	18518 x 2
EK-6100j	3000 x 1	6100 x 0.01	192.90 x 0.01	3858.1 x 0.1	13.228 x 0.001	9259.4 x 2



A&D HR SERIES

- Diamond scale
- HR-60 is legal-for-trade, class II
- Large weighing chamber holds up to a 250mm volumetric flask
- Wide angle LCD display
- Good Laboratory Practices [GLP] Software
- Multi-functional weighing: gram, troy ounce, pennyweight, pound, ounce, & grain
- Separate, clearly marked operating keys
- Full range tare
- Counting Function: Maximizes accuracy with Automatic Counting Accuracy Improvement Function [ACAI]
- Push button calibration
- Front key selectable weighing filters: Ensures fast and stable results in all environmental conditions without switching off the balance

- Digital tare
- Outputs serial number of the balance: Identifies stolen balance and greatly reduces capital goods inventory control
- Enter balance's ID Number: for GLP records and identifying the balance
- Body and frame constructed of extra strong die-cast aluminum alloy
- Percentage and counting modes
- Digital preset tare
- One-touch printing
- Last digit suppression
- GLP/LIMS/ISO compliant
- Five-year warranty

Order #	Model	Trade Legal	1+
51-4076	HR-60	Y	\$1,299.00

Model	Carat	Gram	Troy Ounce	Pennyweight	Grain
HR-60	300 x 0.001	60 x 0.001	1.9 x 0.000005	38 x 0.0001	925 x 0.002

A&D FX SERIES

- Compact SHS (Super Hybrid Sensor) 1 Second Stabilization
- Quick USB interface (FXi-02)
- Standard RS-232C interface
- Comparator function
- Digital calibration function
- LAN-Ethernet interface (FXi-08) with WINCT-Plus Software
- Five-year limited manufacturer's warranty

Item	Order #	Model	Pan Size	Trade Legal	1+
A	51-4073	FX-600CT	5.1"	N	\$769.00
B	51-4074	FX-120GD	5.1"	N	\$639.00
C	51-4075	FX-300GD	5.1"	N	\$695.00
D	51-4090	FX-300IN	5.2"	Y	\$1,099.00

*Grams only legal in USA and Canada. Legal to .1 gram.

Model	Carat	Gram
FX-600CT	600 × 0.001	120 × 0.001
FX-120GD	610 × 0.001	122 × 0.001
FX-300GD	1600 × 0.005	320 × 0.001
*FX-300IN	300 × 0.01	—



Minnesota and Canada Legal

A&D HT-500 SCALE

The HT Series is a multi-functional, durable, compact scale.

- Clear LCD display
- Four AA batteries included
- Auto power-off function
- Hard plastic carrying case included
- Not trade legal
- Two-year warranty
- AC adaptor included
- Measures in grams, ounces, pound-ounce, tael, ticals, and Newtons, carat weight, pennyweight, troy ounce

Order #	Description	Capacity	Scale	12+	6+	1+
51-4084	HT-500GD	510 g	0.1 g	\$118.96	\$125.96	\$139.95

**A&D EJ SERIES SCALE**

The EJ "Newton" precision compact balances offer a multitude of features for a diverse variety of weighing applications.

- LCD display with backlight
- Percentage and counting
- Full digital calibration
- AC power or alkaline battery operation (batteries not included)
- RS232C and USB output optional
- Five-year warranty
- Not trade legal

Item	Order #	Model	Capacity	Readability	12+	6+	1+
E	51-4080	EJ-2000	2100 g	0.1 g	\$168.30	\$178.20	\$198.00
F	51-4082	EJ-120	120 g	0.01 g	\$216.75	\$229.50	\$255.00
G	51-4083KIT	EJ-120 Scale with Density Kit			\$291.93	\$309.11	\$343.45
H	51-4081	Density Kit			—	—	\$69.00





6 $\frac{1}{16}$ " x 7 $\frac{1}{16}$ " x 2 $\frac{3}{16}$ "

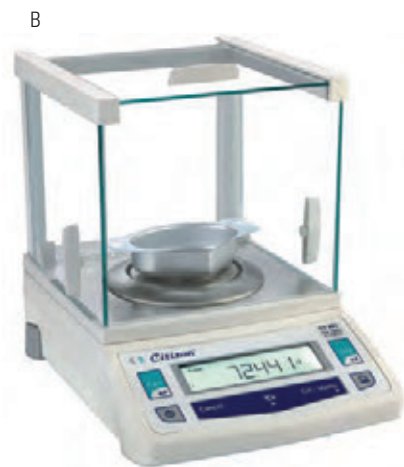

11 $\frac{1}{2}$ " x 9 $\frac{1}{16}$ " x 7 $\frac{1}{16}$ "

CITIZEN™ HIGH PERFORMANCE SCALES

- A. - HBM high precision strain gauge loadcell
 - Rugged construction with stainless steel platform
 - Auto zero tracking, auto calibration
 - Backlit LCD display
 - Standard RS232C interface
 - Various weighing units like carat, gram, pennyweight, ounce, grain, pounds, troy ounce
 - An AC adapter 110V or 6 AA batteries (not included)
- B. - Fastest response time with highly stable reading
 - Standard SR232 interface
 - Large backlit LCD display for easy viewing
 - Parts counting units like carat, gram, pennyweight, ounce, grain, pound, troy ounce
 - Die-cast aluminium design for long term stability and accurate results - Specially designed for diamond weighing

Item	Order #	Model	Capacity	Readability	12+	6+	1+
A	51-2108	CT1202	1200 g	0.01 g	\$318.75	\$337.50	\$375.00
B	51-2110	CT603	600 ct	0.001 ct			\$895.50



C



D

Pan size: 4 $\frac{1}{16}$ "

CITIZEN™ HIGH PERFORMANCE DIAMOND BALANCE

Citizen's new and improved precision series incorporates unique and unequaled high end technology built to match the highest international standards. The result is a TEN fold increase in weighing performance, which maintains our proven, simple, and easy to use operator interface. Attractive quality of this new design is demonstrated by the CZ mark of conformity.

- Compact and space saving
- Standard RS232C interface data output
- Back-lite LCD display for easy viewing function
- Six different weighing units such as grain, pounds, ounces, carat, penny weight, troy ounce
- Piece counting and percentage weighing function
- CZ1200 and CZ1202 are legal for trade
- With AC adapter

Item	Order #	Model	Capacity	Readability	12+	6+	1+
C	51-2105	CZ602	600 g	0.01 g	\$322.15	\$341.10	\$379.00
	51-2111	CZ1200	1200 g	0.1 g	\$265.80	\$281.43	\$312.70
D	51-2112	CZ1202	1200 g	0.01 g			\$689.00

*Grams only legal in USA and Canada. Legal to 0.1 gram.



Find added video content on Stuller.com.

CITIZEN™ HIGH PERFORMANCE COMPACT SCALES

These jewelry scales have hinged wind screens, stainless steel platform, and a lid display. They include a case, an adapter, scoop, and individual weight.

- Multiple weighing units like carat, gram, pieces, ounce, penny weight, troy ounce, grain
- Integrated overload protection that protects in transport
- Fastest response time with highly stable reading
- Fully automatic calibration for 100% accuracy
- 4 AA batteries (not included)

Item	Order #	Model	Capacity	Readability	12+	6+	1+
A	51-2106	CB30	30/150 g	0.01 g	165.75	175.50	195.00
	51-2109	CB100	100 g	0.002 g	247.78	262.35	291.50

**GEMORO® PLATINUM PRO 6000**

- penny weight, troy ounce, ounce, pound
- Push button digital calibration, tare, memory, overload protection, battery saving auto-off, and beep tone functions
- Parts counting PCS
- Precision load cell technology
- Adjustable height feet and leveling bubble indicator
- Low battery and weight stability indication
- Large size, adjustable, bright blue backlit LCD display
- 6.5" x 4.5" removable stainless steel weighing platform
- Removable protective splash guard dust cover
- Powered by 6 AA batteries or included auto-adjustable, universal voltage 100V-240V AC adapter
- Heavy-duty, long-life ABS construction with exclusive protective rubberized paint finish
- Five-year limited replacement warranty

Order #	Model	Capacity	Scale	12+	6+	1+
51-2089	PRO 6000	6000 g	0.1 g	\$152.15	\$161.10	\$179.00

**GEMORO® PLATINUM PRO 1601**

Offers significantly greater capacity than competitive scales, plus the precision, durability, and features you need!

- 1600 x 0.1g, penny weight, troy ounce, grain, ounce
- Parts counting
- Push-button digital calibration, tare, memory, overload protection and auto-off functions
- Large stainless steel weighing platform
- Extra large adjustable backlit LCD display
- Durable ABS construction with exclusive protective rubberized Dura-Paint® with removable protective splash guard dust cover
- Adjustable feet and leveling bubble
- Powered by long-lasting AA alkaline batteries or by its exclusive universal voltage 100V-240V AC Adapter
- Batteries and stainless steel calibration weight included
- Five-year limited replacement warranty

Order #	Model	Capacity	Scale	12+	6+	1+
51-2077	PRO 1601	1600 g	0.1 g	\$105.40	\$111.60	\$124.00





GEMORO® PLATINUM 800SS

The Platinum 800SS is the jewelry industry’s most popular pocket sized gold scale for many reasons. It is an ultra thin design, but offers an extra large stainless steel weighing platform capable of accommodating most any size gold or platinum jewelry. This scale is built to last, with premium quality digital electronics, long-life ABS construction, overload protection and more.

- 800g x 0.1 g, penny weight, troy ounce, ounce
- Large stainless steel weighing platform
- Bright blue backlit LCD display
- Push button digital calibration, tare, memory, low battery indicator and battery saving auto-off functions
- Powered by (2) included CR2032 lithium batteries
- Includes protective leatherette carrying pouch and built-in removable tray for holding jewelry, findings and more
- Durable ABS construction
- 5-year limited replacement warranty

Order #	Model	Capacity	Scale	12+	6+	1+
51-2300	800SS	800 g	0.1 g	\$22.91	\$24.26	\$26.95



GEMORO® PLATINUM PRO 801

- penny weight, troy ounce, pound, gram, ounce
- Parts counting
- Push-button digital calibration, tare, memory, overload protection, and auto-off functions
- Powered by long-lasting AA alkaline batteries or by its exclusive universal voltage 100V-240V AC adapter
- Batteries and stainless steel calibration weight included
- 5-year limited manufacturer's replacement warranty

Order #	Model	Capacity	Scale	12+	6+	1+
51-2094	PRO 801	800 g	0.1 g	\$63.71	\$67.46	\$74.95



GEMORO® PLATINUM V300

Features an ultra bright blue backlit display and protective cover that slides off and also serves as an ideal weighing tray.

- penny weight, troy ounce, ounce
- Push-button digital calibration, tare, backlight, memory, low-battery indicator, and battery saving auto-off functions
- Powered by long-life AAA batteries (included)
- 5-year limited manufacturer's replacement warranty.

Order #	Model	Capacity	Scale	12+	6+	1+
51-2097	V300	300 g	0.1 g	\$16.96	\$17.95	\$19.95
51-2097	V600	600 g	0.1 g	—	—	\$11.95



GEMORO® PLATINUM XP500

The XP500 from GemOro is our extra precision gold scale with amazing accuracy of 0.01g and the best scale for the job!

- 500g x 0.01 g, penny weight, troy ounce, carat, grain, ounce
- Bright blue backlit LCD display
- Push button digital calibration, tare, memory, low battery indicator and battery saving auto-off functions
- Parts counting
- Convenient 4-button control panel
- Powered by (2) included long-life AAA alkaline batteries
- Includes both an extra large and low profile protective cover that also serves as a tray for holding jewelry, findings and more
- Black EZ-grip rubberized paint finish
- 5-year limited replacement warranty

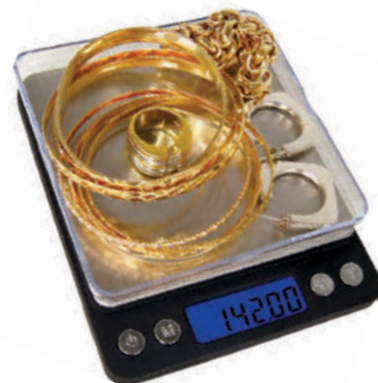

Order #	Model	Capacity	Scale	12+	6+	1+
51-2034	XP500	500 g	0.01 g	\$33.96	\$35.96	\$39.95

GEMORO® PLATINUM PRO501VXP

The Platinum PRO501VXP offers the extra precision you want, combined with the durability and features you need.

- Capacity / Readability: 500g x 0.01 g, troy ounce, ounce, penny weight, carat, grain
- Pushbutton digital calibration, tare, memory, overload protection and battery saving auto-off function
- Parts counting PCS
- Stainless steel weighing platform
- Adjustable height feet and leveling bubble indicator
- Low battery and weight stability indication
- Large bright blue backlit LCD display
- Powered by 4 supplied AA batteries or included universal voltage 100V-240V AC adapter
- Includes (2) 200g calibration weights
- Black EZ-grip rubberized paint finish
- 2-year limited replacement warranty



Order #	Model	Capacity	Scale	12+	6+	1+
51-2036	501VXP	500 g	0.01 g	\$76.46	\$80.96	\$89.95

GEMORO® PLATINUM PRO1001V

The Platinum PRO1001V offers the precision you want, combined with the durability and features you need.

- Capacity / Readability: 1000g x 0.1 g, troy ounce, ounce, penny weight, carat, grain, kilogram
- Pushbutton digital calibration, tare, memory, overload protection and battery saving auto-off function
- Parts counting PCS
- Large stainless steel weighing platform
- Adjustable height feet and leveling bubble indicator
- Low battery and weight stability indication
- Large bright blue backlit LCD display
- Powered by (4) supplied long-lasting AA alkaline batteries
- 2-year limited replacement warranty



Order #	Model	Capacity	Scale	12+	6+	1+
51-2037	1001V	1000 g	0.1 g	\$46.71	\$49.46	\$54.95



Find added video content on Stuller.com.

GEMORO® PLATINUM PCT 101 CARAT SCALE

- gram, pennyweight, ounce, troy ounce, carat, and grain
- Parts counting function
- Large stainless steel weighing platform and bright blue backlit display
- Push-button digital calibration, tare, memory, low battery indicator, and battery saving auto-off functions - Innovative low profile tinted draft shield manually expands for weighing large diamonds, gemstones, and parcels
- Durable ABS construction with UltraGrip rubberized paint finish
- Includes a rubberized protective travel/storage case with compartments containing scale, stainless steel calibration weight, stainless steel weighing platform, scoop, AC adapter, and Swiss-style locking diamond tweezers
- Powered by four long-life included AAA batteries or its supplied universal voltage 100-240V AC adapter
- 5-year limited replacement warranty

Order #	Model	Capacity	Readability	12+	6+	1+
51-2075	PCT101	100 g	0.005 ct	\$71.40	\$75.60	\$84.00



Find added video content on Stuller.com.

GEMORO® PLATINUM PCT 251 CARAT SCALE

- gram, pennyweight, ounce, troy ounce, and grain
- Parts counting function
- Large stainless steel weighing platform and bright blue backlit display
- Push-button digital calibration, tare, memory, low battery indicator, and battery saving auto-off functions
- Innovative low profile tinted draft shield manually expands for weighing large diamonds, gemstones, and parcels
- Durable ABS construction with UltraGrip rubberized paint finish
- Includes a rubberized protective travel/storage case with compartments containing scale, stainless steel calibration weight, stainless steel weighing platform, scoop, AC adapter, and Swiss-style locking diamond tweezers
- Powered by four long-life included AAA batteries or its supplied universal voltage 100-240V AC adapter
- 5-year limited replacement warranty

Order #	Model	Capacity	Readability	12+	6+	1+
51-2076	PCT251	250 g	0.005 ct	\$84.15	\$89.10	\$99.00



GEMORO® PLATINUM® MP601

This scale gives you the features and performance you would expect from a scale which costs twice the price.

- 600g x 0.1 gram, troy ounce, ounce, and pennyweight
- Large stainless steel weighing platform
- Bright blue backlit LCD display
- Push button digital calibration, tare, memory, low battery indicator and battery saving auto-off functions
- Parts counting
- Hinged cover is removable and also serves as a convenient weighing tray
- Powered by (2) included long-life AAA alkaline batteries
- Includes stainless steel weighing platform, tray and a protective leatherette carrying pouch
- Black EZ-grip rubberized paint finish
- 5-year limited replacement warranty

Order #	Model	Capacity	Scale	12+	6+	1+
51-2098	MP601	600 g	0.1 g	\$25.46	\$26.96	\$29.95

TANITA™ SCALE 1230 CARAT SCALE

- 100 carat capacity with 0.1 carat readability (20g x 0.002g)
- Weighs in carat, gram, pennyweight, and grain
- Large, easy-to-read five digit LCD display
- Simple, automatic calibration with included 20g calibration weight
- Programmable automatic power off (0 to 60 seconds)
- Energy saving feature saves batteries
- Overload indicator
- Large transparent lid protects balance
- 4.5cm platform - Dimensions: 15.5 x 8.4 x 2.8cm
- Three-year manufacturer's warranty

Specifications:

Capacity: 100 carat

Accuracy: Carat 0-50/0-100ct 0.01ct.

Troy ounces 0-0.32toz. 0.0001toz.

Grain 0-154gn 0.05gn

Gram 0-1

Measures 6" x 4½" x 1"



Order #	Model	Capacity	Scale	12+	6+	1+
51-2005	1230	100 g	0.1 g	\$224.36	\$237.56	\$263.95

BENCH SCALES

A. Weighs in grams, ounces, troy ounces, and pennyweights. Large plate makes weighing large objects easy. Use a 9V battery which is included.

B. Weighs in grams, ounces, troy ounces, and pennyweights. Removable scale cover can be used to hold items to be weighed. Spring-loaded display and keyboard retracts into scale body. Comes with a soft cover. Uses four AAA batteries, which are included.

C. Weighs in grams, ounces, pennyweight and grains. Also has parts counting. Protective cover folds out of the way so larger objects can be weighed. Comes with a weighing pan protector that can be used to hold objects to be weighed. Uses two AAA batteries, which are included.



Item	Order #	Description	Capacity	Readability	12+	6+	1+
A	51-4060	Bench Scale	1000 g	0.1 g	\$38.72	\$41.00	\$45.55
B	51-4061	Scale	2000 g	0.1 g	\$29.71	\$31.46	\$34.95
C	51-4062	Pocket Scale	500 g	0.1 g	\$19.81	\$20.97	\$23.30

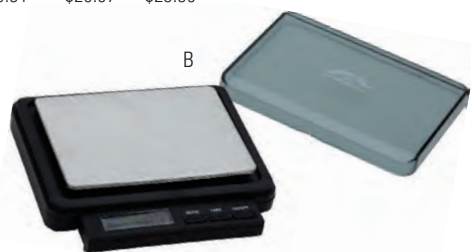

SCALE WEIGHTS

Made from durable, polished stainless steel. Can be used to calibrate bench scales.

Order #	Capacity	12+	6+	1+
51-0000	50 g	\$8.97	\$9.49	\$10.55
51-0000	100 g	\$8.97	\$9.49	\$10.55
51-0000	200 g	\$8.97	\$9.49	\$10.55
51-0000	500 g	\$8.97	\$9.49	\$10.55
51-0000	1000 g	\$26.99	\$28.58	\$31.75
51-0000	5000 g	\$54.02	\$57.20	\$63.55



Screwdrivers



A



B



C

PRECISION-MADE SCREWDRIVER SET

Nine color-coded screwdrivers on rotating stand and replacement blades with set screws to hold blade firmly. Hexagonal swivel head prevents rolling. Length is proportional to blade size. Length ranges from 4 1/8" to 3 1/4". Magnetic.

Item	Order #	Description	12+	6+	1+
A	52-5400	Screwdriver Set (9-Pieces)	\$53.34	\$56.48	\$62.75
B	52-5401	Replacement Set Screw for Blade	\$1.32	\$1.40	\$1.55

Item	Order #	Blade Size	Length	Color	Per Unit	12+	6+	1+
INDIVIDUAL BLADES								
	52-5406	0.6mm	.024"	Pink	3	\$1.27	\$1.35	\$1.50
	52-5408	0.8mm	.031"	Yellow	3	\$1.27	\$1.35	\$1.50
	52-5410	1mm	.039"	Black	3	\$1.27	\$1.35	\$1.50
	52-5412	1.2mm	.047"	Red	3	\$1.27	\$1.35	\$1.50
	52-5414	1.4mm	.055"	Gray	3	\$1.27	\$1.35	\$1.50
	52-5416	1.6mm	.063"	Purple	3	\$1.87	\$1.98	\$2.20
	52-5420	2mm	.078"	Green	3	\$1.87	\$1.98	\$2.20
	52-5425	2.5mm	.089"	Blue	3	\$2.25	\$2.38	\$2.65
	52-5430	3mm	.118"	Brown	3	\$2.25	\$2.38	\$2.65

C INDIVIDUAL SCREWDRIVERS

	52-5508	0.6mm		Pink	Each	\$4.68	\$4.95	\$5.50
	52-5507	0.8mm		Yellow	Each	\$4.68	\$4.95	\$5.50
	52-5506	1mm		Black	Each	\$4.68	\$4.95	\$5.50
	52-5505	1.2mm		Red	Each	\$4.68	\$4.95	\$5.50
	52-5504	1.4mm		Gray	Each	\$4.68	\$4.95	\$5.50
	52-5503	1.6mm		Purple	Each	\$4.68	\$4.95	\$5.50
	52-5502	2mm		Green	Each	\$4.68	\$4.95	\$5.50
	52-5501	2.5mm		Blue	Each	\$4.25	\$4.50	\$5.00
	52-5500	3mm		Brown	Each	\$4.68	\$4.95	\$5.50



D

ECONOMY SCREWDRIVER SET

Set of nine screwdrivers in an aluminum base holder with an extra blade storage compartment. Blade sizes range from 0.6 to 2.0mm. Made in India.

Item	Order #	Description	12+	6+	1+
D	52-5470	Screwdriver Set (9-Pieces)	\$12.62	\$13.37	\$14.85



E

EUROPEAN FIXED-BLADE SCREWDRIVER SET

European fixed-blade screwdrivers with color-coded bands to indicate sizes. Precisely ground, tempered blades with nickel handles and hex heads. Excellent quality matched with economy make these a winner.

Item	Order #	Description	Blade Size	Color	12+	6+	1+
E	52-1037	Screwdriver Set (6-Pieces)			\$15.05	\$15.93	\$17.70
INDIVIDUAL SCREWDRIVERS							
	52-1043		2.0mm	Green	\$2.30	\$2.43	\$2.70
	52-1042		1.6mm	Violet	\$2.30	\$2.43	\$2.70
	52-1041		1.4mm	Gray	\$2.00	\$2.12	\$2.35
	52-1040		1.2mm	Red	\$2.00	\$2.12	\$2.35
	52-1039		1.0mm	Black	\$2.00	\$2.12	\$2.35
	52-1038		0.8mm	Yellow	\$2.00	\$2.12	\$2.35

SCREWDRIVER SET IN POUCH

Six-piece screwdriver set in a pouch. Popular series of screwdrivers featuring color-coded hex heads and reversible blades. Blades are tempered and finely ground to exact specifications. Made in France.

Item	Order #	Description	Blade Size	Color	12+	6+	1+
A	52-1045	Screwdriver Set (6-Pieces)			\$20.36	\$21.56	\$23.95
B	52-1046	Replacement Blade Set, 3 sizes each (18-Pieces)			\$9.01	\$9.54	\$10.60

INDIVIDUAL BLADES

52-1060	0.6mm	Blue	\$1.83	\$1.94	\$2.15
52-1059	0.7mm	Silver	\$1.83	\$1.94	\$2.15
52-1058	0.8mm	Red	\$1.83	\$1.94	\$2.15
52-1057	1.0mm	Brown	\$1.83	\$1.94 <td \$2.15	
52-1056	1.2mm	Green	\$1.83	\$1.94	\$2.15
52-1055	1.3mm	Black	\$1.83	\$1.94	\$2.15
52-1054	1.5mm	Orange	\$1.83	\$1.94	\$2.15



A

B

**MINI SCREWDRIVER KIT**

Our value-engineered screwdriver set features three straight blades and three Phillips screwdrivers, all in small sizes.

Set includes one each of the following:

Phillips: 1.4mm, 1.6mm, and 2mm.

Flathead: 1.2mm, 1.4mm, and 1.6mm.

This may be the handiest set available today for small jobs.

Order #	Description	12+	6+	1+
52-1065	Screwdriver Set (6-Pieces)	\$5.61	\$5.94	\$6.60

**MASCOT™ SCREWDRIVER SET**

This handsome set consists of six ergonomically shaped, lightweight screwdrivers molded in texturized plastic. The screwdriver shafts are molybdenum steel, hardened and chrome plated for strength and torque.

Set includes one each of the following 50mm screwdrivers:

Phillips: .90mm, and 1mm.

Flathead: 1.5mm, 2mm, 2.4mm, and 3mm.

Order #	Description	12+	6+	1+
52-1070	Screwdriver Set (6-Pieces)	\$11.05	\$11.70	\$13.00



Screwdrivers

**NON-MAGNETIC SCREWDRIVERS**

Precision European screwdrivers. Made with hexagonal swivel heads, which prevent rolling. Handles are knurled to allow a firm grip. Each screwdriver has a color-identifier band to allow easy selection. Blades are held in place with set screws. Flat head only.

Order #	Description	Blade Size	Color	12+	6+	1+
52-0902	Screwdriver	0.8mm	Yellow	\$4.68	\$4.95	\$5.50
52-0903	Screwdriver	1mm	Black	\$4.68	\$4.95	\$5.50
52-0904	Screwdriver	1.2mm	Red	\$4.68	\$4.95	\$5.50
52-0905	Screwdriver	1.4mm	Gray	\$4.68	\$4.95	\$5.50

REPLACEMENT BLADES

52-0906	.024" (length)	0.6mm		\$0.77	\$0.81	\$0.90
52-0907	.031" (length)	0.8mm		\$0.77	\$0.81	\$0.90
52-0908	.035" (length)	1mm		\$0.77	\$0.81	\$0.90
52-0909	.047" (length)	1.5mm		\$0.77	\$0.81	\$0.90
52-0910	.055" (length)	1.4mm		\$0.77	\$0.81	\$0.90

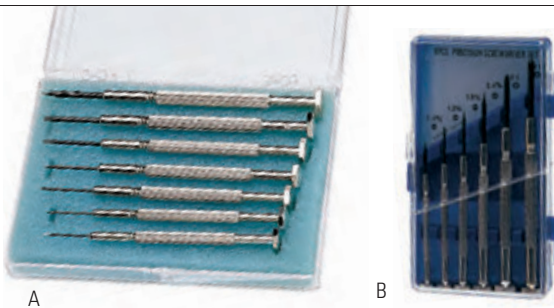
**SCREWDRIVER SETS**

A. Economical screwdrivers with steel blade set firmly in metal handles. Hexagon swivel head prevents rolling on bench. Includes 1.8mm, 1.5mm, 1.2mm, 1.0mm, 0.8mm, 0.7mm, and 0.6mm.

B. Set includes four straight blade screwdrivers (1.4mm, 2mm, 2.4mm, 3mm) along with 3mm and 3.5mm Phillips screwdrivers. All have hexagonal swivel heads. Packed in a convenient, hard plastic box.

Item	Order #	Description	12+	6+	1+
A	52-5140	Screwdriver Set (7-Pieces)	\$35.57	\$37.67	\$41.85
B	52-1066	Screwdriver Set (6-Pieces)	\$2.81	\$2.97	\$3.30

**COMBINATION PHILLIPS AND FLAT COMFORT GRIP SCREWDRIVER SET**

C. Includes: 3 – Phillips head screwdrivers

3 – Flat head screwdrivers (1.4mm, 1.8mm, and 2.4mm)

D. Includes: 6 – Flat head screwdrivers

(1.4mm, 1.6mm, 1.8mm, 2.0mm, 2.4mm, and 3.0mm)

Item	Order #	Description	12+	6+	1+
C	52-5445	Combination Set	\$2.81	\$2.97	\$3.30
D	52-5440	Flat Head Set	\$2.81	\$2.97	\$3.30

COLOR-CODED HEXHEAD SCREWDRIVER SET

A popular series of screwdrivers that feature color-coded hex heads, reversible blades, and are nickel-plated to prevent rusting. Blades are tempered and finely ground to exact specifications. Made in France.

Item	Order #	Description	12+	6+	1+
E	52-1025	Screwdriver Set (7-Pieces)	\$33.53	\$35.51	\$39.45

Order #	Blade Size	Length	No.	Per Unit	12+	6+	1+
52-1026	1.5mm	.050"	3	12	\$11.22	\$11.88	\$13.20
52-1027	1.28mm	.050"	4	12	\$11.22	\$11.88	\$13.20
52-1028	1.2mm	.047"	5	12	\$11.22	\$11.88	\$13.20
52-1029	1mm	.039"	6	12	\$11.22	\$11.88	\$13.20
52-1030	0.8mm	.031"	7	12	\$11.22	\$11.88	\$13.20
52-1031	0.7mm	.027"	8	12	\$11.22	\$11.88	\$13.20
52-1032	0.6mm	.024"	9	12	\$11.22	\$11.88	\$13.20

REPLACEMENT BLADES



POCKET SCREWDRIVER SET

This pen-size, aluminum holder with nicely finished anodized barrel and pocket clip has a built-in chuck made of steel and pressed into the barrel to firmly hold screwdriver blades and prevent turning. The screwdriver blades are made of heat treated alloy steel for strength and durability, and may be stored inside the barrel. Designed for convenience and versatility. Length 3 $\frac{3}{4}$ ". Barrel diameter $\frac{3}{8}$ ". A quality, U.S.-made product.

Order #	Description	12+	6+	1+
52-1035	Screwdriver Set (5-Pieces)	\$17.17	\$18.18	\$20.20
52-1036	Replacement Blades (5-Pieces)	\$9.27	\$9.81	\$10.90

**16 PIECE SCREWDRIVER AND TOOL SET**

Includes:

4 – Phillips head screwdrivers

6 – Flat head screwdrivers

(1.0mm, 1.4mm, 2.0mm, 2.4mm, 3.0mm, and 3.8mm)

3 – Hex head tools (1.5mm, 2.0mm, and 2.5mm)

3 – Nut drivers (3.0mm, 4.0mm, and 5.0mm)

Order #	Description	12+	6+	1+
52-5450	Screwdriver Set (16-Pieces)	\$5.36	\$5.67	\$6.30

**PRECISION SCREWDRIVER**

Aluminum knurled body for a sure grip and hex-swivel head that won't roll with four reversible blades.

Order #	Description	12+	6+	1+
52-1034	Phillips and Flat Screwdriver Set	\$7.48	\$7.92	\$8.80

**REVERSIBLE SCREWDRIVER**

Includes blades: 1.5mm, 1.6mm, 1.8mm, 2.0mm.

Order #	Description	12+	6+	1+
52-1033	Reversible Screwdriver	\$8.41	\$8.91	\$9.90

**SCREWDRIVER SHARPENER**

Spring action holds screwdriver firmly in place as tool is rolled back and forth on a sharpening stone. Steel wheels are carefully set into body to provide even action when wheeling over stone.

Order #	Description	Width	12+	6+	1+
52-1011	Screwdriver Sharpener	1 $\frac{1}{16}$ "	\$9.73	\$10.31	\$11.45

**DOUBLE-ENDED WAX CARVER SET**

Polished hardwood stand for screwdrivers and wax carvers. Carborundum stone built into base for sharpening.

Order #	W x H	Depth	12+	6+	1+
52-1012	4" x 2 $\frac{1}{2}$ "	2 $\frac{5}{8}$ "	\$9.05	\$9.59	\$10.65



Rofin Laser Welders

The new Performance redefines the manual laser welding with many application-driven innovations and numerous technical refinements in an entirely newly designed housing. Rofin took a close look at how users were using their lasers and entirely redesigned the working chamber and access to it. The new hinged cover provides wide and completely free access to a spacious working area and can be operated with one hand whilst using the other hand to hold the workpiece.



Basic Configuration:

- Mobile unit with front lockable wheel
- 10x Jena Microscope (15x total magnification in working chamber)
- Pulse shaping
- LCD View shutter
- Two halogen lights for illumination of working chamber
- Shielding gas nozzle
- Removable base plate for large parts
- Self-Diagnostic Programming

- **Entirely New Housing Design** — Ergonomic microscope and arm position. Slender foot area offers comfortable seating position. Flat surface for placing workpieces and tools.
- **Revolutionary Working Chamber Design** — Easy, barrier-free access through wide opening door. Single-handed opening, other hand may stay in working position. Removable bottom plate for huge and bulky workpieces.
- **Quality Engineering** — Meets latest German industrial standards. iC driven control board and state of the art power supply. Exhaust system with HEPA and integrated spark filter.
- **Easy Access and Maintenance** — Easy and fast exchange of flash lamp. Tool-free access to cooling water and exhaust filter. Exhaust system with filter diagnostics. Control board with easy diagnostics.
- **SweetSpot®** — Patented resonator design. No first-pulse effect. Constant weld quality from the very first pulse. Assures a reliable welding process.
- **MicroWeld™** — Weld spots with less than 0.1 mm diameter. For extremely fine welds and delicate workpieces.
- **TrueView™** — Ensures a 100 % hit-rate even when working out of focus. The laser beam is always aligned to the crosshair. No parallax misalignment.
- **Strong and Reliable** — Powerful power supply for high repetition rates. Generously sized cooling unit.
- **Large Color Touch Screen** — Brilliant 5.7" screen with high contrast. Entirely menu-driven operation via touch screen. Laser status indicator, direct access to laser parameters. Comfortable graphic pulse-shape editor.
- **Dynamic Foot Switch** — Offers sensitive control of an arbitrary laser parameter. Acts like a foot throttle and is easy to configure. Triggers start-and-end-ramp when using Pulse Ramping mode. Adjusts welding speed or power during welding.
- **ECMode™** — Switches off system parts during idle times. Only 10 W power consumption vs. 200 W in standby mode. Fast restart within less than 1 sec at any time. Reduced costs due to less lamp wear.
- **SPEEDmode™** — Significant power increase within a certain timespan. Shorter process time through higher pulse frequencies. System reloading during welding intermissions for workpiece handling.
- **BURSTmode™** — Fires laser pulses of a predefined number. Stops automatically when number of pulses is reached. Risk-free working with fast pulse sequences. Increased processing speed.
- **Pulse Ramping** — Successively increases/decreases the power of first/last laser pulses. Ideally suited for closed seam welds and gas-tight housings. A good choice for starting a weld on highly reflective material. Reduced risk of piercing thin material. Pulse Shaping - Graphic shape editor for defining the pulse intensity over time. Precise control of coupling, fusion and cooling phase. Preset pulse shapes for many materials. Perfect welds even of highly reflective metals and alloys.
- **IPMmode™** — Intelligent Pulse Management. Guarantees high pulse to pulse stability. Especially suited for micro welds. Optimized lamp operation due to sophisticated control.

ROFIN STARWELD JEWELRY MICROWELDER

Order #	Description	1+
14-0110	Starweld Performance 7002	\$28,500.00

ROFIN STARWELD PERFORMANCE 6002 BASIC

- Ergonomically designed for operational comfort; built by the world's most experienced laser technology company
- Manual spot/seam microwelding system with max energy to 80 joules
- Ideal for spot and seam welding for gold, silver, platinum, titanium, copper, aluminum and high-grade steel alloys
- Time-saving technique – Welding even in the direct vicinity of heat sensitive parts, such as precious stones, without removing them from their settings
- The unique Sweet Spot Resonator™ improves laser beam quality and increases the ease of use for the operator
- Patented Pulse Shaping for designed and controlled laser energy
- Independently-opening gull-wing doors
- Variable-size workspace (removable bottom plate)
- Easy-to-use programming and real text information on graphic display
- Noise reduction for all moving parts; allows operation in quiet environment
- Nominal output power max. – 40 watt
- Pulse energy max. – 80 Joule
- Pulse peak power max. – 4.0 kW
- Pulse width – 0.5-20 msec
- Pulse frequency – Single Shot - 20 Hz
- Motorized beam expansion – 0.25-2.0 mm
- Electrical – 208-240V, 16A, 50/60 Hz, single phase
- Power consumption max. – 1.3-1.7 kW
- Cooling unit – Internal water-air heat exchanger
- Shielding gas – Connection for shielding gas

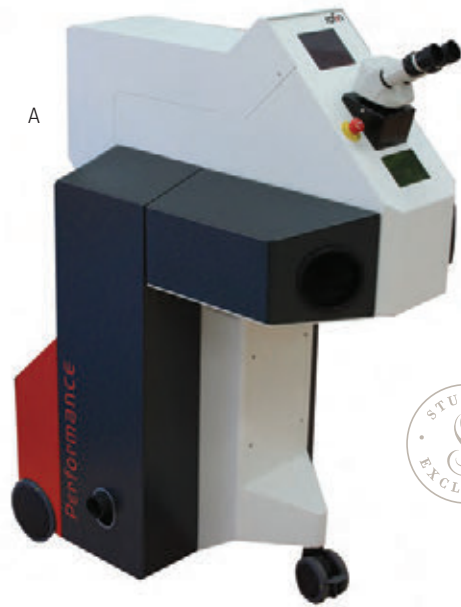

Item	Order #	Description	1+
A	14-0110	6002 Basic	\$22,970.00

ROFIN STARWELD DESKTOP MICROWELDER

Packed in an attractive housing design with a small footprint, this new Desktop laser is outstanding. Smaller than ever and yet equipped with more power, the Desktop benefits from the innovative technology of its big brother, the StarWeld Performance. Computer-controlled laser pulses and monitored cooling make it a very reliable tool. Everyday work processes are made comfortable thanks to easy handling and supportive weld assist systems. The modern housing design is tailor made for shops with little room available and at the same time provides a large working chamber.

- Compact and modern housing design with small footprint
- Easy set-up, automatic adjustment to power available 100V/230 V
- Color TFT touch display
- Weld assist systems
- TrueView™
- BURSTmode™
- ECOmode™
- Nominal power – 60W
- Max. power with SPEEDmode™ – 100W
- Pulse peak power – 8kW
- Pulse energy – 60 Joule
- Pulse frequency – single, 1-50 Hz
- Pulse width – 0.3-50 msec
- Focal diameter – 0.3-2 mm
- Electrical – 110/230V, 60/50 Hz, 16/13A (single phase)
- Standby consumption – 200W
- 540mm W x 460mm H x 690mm D
- Nominal power consumption – 1700W
- ECOmode™ – 10W



Item	Order #	Description	1+
B	14-0135	Starweld Desktop Welder	\$19,500.00

SPECIAL ORDER REPLACEMENT PARTS

- | | |
|--|---|
| 14-0115 Scipe Optics for AB Laser | 14-0125 Lens Paper Pack of 50 |
| 14-0116 Mini-Camera for Laser | 14-0127 Flow Plate |
| 14-0117 Laser Cuffs for Laser | 14-0128 6002 Series Air Filter |
| 14-0120 Flash Lamp | 14-0129 Lab Jack |
| 14-0121 2mm Protection Glass | 14-0130 Empty Wire Spools |
| 14-0122 Water Filter | 14-0132 Leica® Wedge |
| 14-0123 5002 Series Air Filter | 14-0133 Laser Head Rest |
| 14-0124 "12V, 20W Halogen Lamp" | 14-0136 Argon Regulator Flow Meter Kit |

ACCESSORIES:

- 23-2500** Finger Tape
- 46-7892** Long Chain
- 46-8160** Small Oval Flush
- 26-4167** Microball
- 10-9104** 3M Bristle Disc, 42-Piece Kit, ¾"



Screen Dimensions:
9" x 11¼" x 2"
6½ lbs

Swing Arm Dimensions:
4" x 5" x 32"
11½ lbs



ORION 200 i² FEATURES:

- New 10" touch screen display
- New Pico mode for extremely small and precise welds
- 3 Pulse Waveforms – Classic, new Triangle, new Square
- New Seam mode – weld up to 30 welds/second
- High frequency agitation – including new negative agitation
- New Internal weld monitoring to provide weld consistency and automatically optimize weld parameters
- Advanced waveform shaping options
- Adaptive Weld Ignition™ – for extended electrode tip life
- Intelligent Welding™ and MyWeld™ software
- Updateable software via USB port
- Pulse arc and resistance welding technology in one machine
- 5x-10x Microscope with built-in shutter for superior viewing without green lens obstruction

ORION PULSE 200I WELDER

Order #	Description	1+
14-0160	Orion 200i	\$7,900.00

ORION 200 i²

Introducing the new Orion 200 i² (patent pending) – An evolution in micro pulse arc welding! Built on the stability of the Orion platform – the Orion 200 i² takes that next leap forward by delivering the most innovative and versatile welder on the market today.

The Orion 200 i² is packed with new features that will simplify the welding needs of any jeweler, goldsmith, or silversmith. Innovative new features include – the new Pico weld mode for intricate welds as small as 0.01 Joules of energy, to achieve truly microscopic weld joints; user selectable up to 200 joules of energy for large silver or platinum pieces; a large 10" touch screen interface with one-touch access to all welding parameters; the ultimate space saving design; and 3 unique pulse shape wave form options to choose from: Classic Orion (for Orion users that have come to love welds produced by the Orion 150i), Triangle (for weld smoothing), and Square (laser like welding).

And introducing the new Seam mode—a revolutionary breakthrough in micro pulse arc welding. Seam mode allows users to mimic laser welding with weld speeds up to 30 welds/sec. Keeping in the Orion tradition of excellent customer service, training, and support we have added on-screen resources, which include video tutorials and a detailed product user manual. The patent pending Orion 200 i² gives you the precision and speed of a laser with the versatility, power, and ease of a pulse arc welder.



ORION 200 i² INTERFACE:

- Large 10" touch screen interface
- Weld energy selection – Set energy by dial, or by keypad. Adjustable from 0.01 – 200 Joules
- Adjust your welds based on energy, peak power or weld current
- One-touch access to weld waveform, ignition, and agitation options
- Weld speed controls with up to 30 welds per second—Seam mode
- Waveform displayed to help users understand pulse arc shaping effects
- Spot size indicator
- Save, load, and advanced settings
- On-screen resources including videos and user manual



ABOUT ORION:

In 2008 Sunstone Engineering’s PhD led team of engineers developed the first Orion Welder. The motivation for this bold move was from the multiple needs expressed by jewelers, goldsmiths, and silversmiths to have an innovative micro welding solution. Applying product features from an extensive micro welding background, Sunstone Engineering created Orion Welders loaded with innovative features that are easy-to-use.

Users can be assured that each Orion Welder is designed, engineered, and manufactured to high quality standards in the U.S.A. The Orion customer support and technical teams can be reached for any user questions, from Orion set-up to welding techniques, the Orion team is a phone call away. Our website and other social media sites offer extensive video archives and Orion community input.

With three models to choose from – the new Orion 200 i², the Orion 150s, and the Orion 100c, Orion welders are affordable and versatile for any budget.

ORION 150s

Like the Orion 200 i², the Orion 150s has both Pulse-Arc and Tack welding capabilities. Tack can be used to temporarily place or permanently join two pieces together. The 150s pulse-arc mode utilizes two separate energy banks, Pulse-Arc and Micro, allowing proper arc ignition regardless of the power settings. Agitation options can also be added in addition to the main weld pulse to allow for added penetration and weld joint strength. The Orion 150s has the power, features and versatility to make it one of the most effective and affordable welding solutions on the market.

- 1-150 Joules of energy
- Pulse Arc and Tack modes of operation
- 7" touch screen interface
- Simple to use interface with easy adjustments and save settings
- USB port for software upgrades
- Microscope and optical shutter for superior work piece viewing



Item	Order #	Description	1+
A	14-0143	ORION 150s	\$4,800.00

ORION 100c

The Orion 100c is a compact, entry-level Pulse Arc welder. It was designed and developed for a smaller space saving bench footprint. It includes an easy-to-use touch screen interface for quick access and adjustments of welding parameters and a simple high-frequency agitation option for difficult to weld metals. The Orion 100c is a great entry-level welder that is affordable for any budget.

- 3-100 Joules of energy
- Pulse Arc operation
- 4.2" touch screen interface
- Simple to use interface with easy adjustments and save settings
- USB port for software upgrades
- Microscope and optical shutter for superior work piece viewing

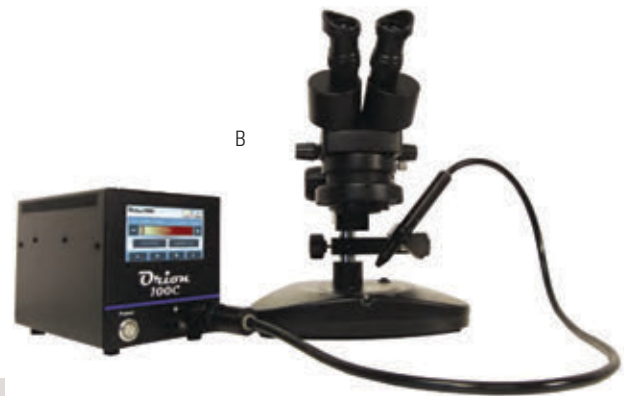

Item	Order #	Description	1+
B	14-0141	ORION 100c	\$3,700.00

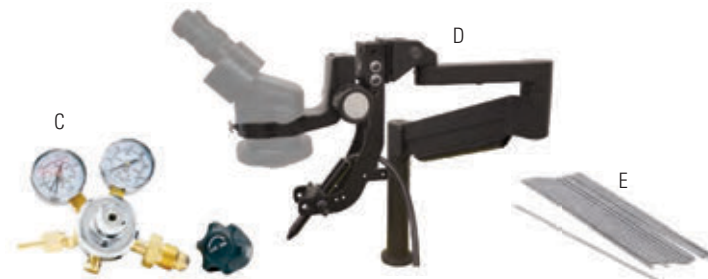

ACCESSORIES

Use with any Orion Welder.

Item	Order #	Description	Tip Diameter	1+
C	14-1628	Argon Gas Regulator		\$79.50
D	14-0145	Free Floating Microscope Swing Arm		\$1,000.00
E	14-0811	Tungsten Electrode Tip	1.0mm	\$45.00
	14-0811	Tungsten Electrode Tip Set	1.0mm–.5mm	\$60.00
	14-0811	Tungsten Electrode Tip	.5mm	\$45.00

TORCH FUEL INFORMATION

Natural Gas

A common composition for natural gas as supplied to the consumer contains 93 parts methane, 5 parts ethane, and 2 parts propane. It is available in both liquefied and gaseous form. This fuel type is considered the most practical fuel for use in making jewelry. When supplied in its liquefied form, it is the least expensive fuel gas traditionally used by jewelers; due in part to its relatively slow burn rate (when compared to hydrogen). When using this gas type in its liquefied form, a regulator is required. A pressure setting of 6-8 PSI is adequate for all jewelry torch work. When supplied in its gaseous form by most utility companies, it is regulated down from 25-36 PSI in the large mains to about 8 PSI for general consumer use. This allows the option of direct piping (which eliminates the need for another tank), and a regulator is not required for reducing the gas pressure. When mixed with oxygen, it burns with a clean, carbon-free flame.

Acetylene

Acetylene is a gaseous hydrocarbon formed by joining hydrogen and carbon in an electrical arc, by the incomplete combustion of other hydrocarbons, or by other means. Although colorless, it has an unpleasant odor, similar to ether, caused by impurities. When combined with oxygen, it produces the hottest, brilliant white flame which is why it is preferred in welding. Although commonly used by many jewelers, it does not burn cleanly, and, due to the presence of unburned hydrocarbons, it is not recommended for working on platinum. Often, these unburned hydrocarbons will produce blackened deposits on jewelry items that have been melted or soldered. A regulator that is specified for use with acetylene is required and a pressure setting between 8015 PSI is suitable for jewelry work.

Propane (LP)

Propane consists of propyl and methane and is supplied in a liquefied form for consumer use. It is an inexpensive fuel and tank refills are widely available. A regulator is required for lowering and stabilizing fuel pressure from the tank. The standard pressure setting for jewelry work is 6-8 PSI. Present regulators, which are sold through most RV (recreational vehicle) supply centers, are available in the pressure ranges that can be used for jewelry. When mixed with oxygen, it burns at a temperature slightly higher than natural gas and produces a clean, carbon-free flame.

NOTE: Although these fuel types combined with compressed air are capable of producing temperatures above the melting point of platinum (see table #1), it is marginal and, therefore, not recommended for platinum work.

CAUTION: Always wear proper eye and face protection.

TABLE #1

MAXIMUM TEMPERATURES FOR GAS & COMPRESSED AIR

FUEL	TEMPERATURES	
	F°	C°
Natural Gas	3,565°	1,962.8°
Propane	3,494°	1,923.3°
Acetylene	3,848°	2,120°

TABLE #2

MAXIMUM TEMPERATURES FOR GAS & OXYGEN

FUEL	TEMPERATURES	
	F°	C°
Natural Gas	5,120°	2,826.7°
Propane	5,252°	2,900°
Acetylene	5,080°	2,804.4°

SAFETY TIP: EYE PROTECTION

Most soldering, and all welding operations on platinum jewelry, involve temperatures in excess of 1,500°C (2,732°F) at the joint face, and between 2,000°C (3,632°F) and 2,800°C (5,072°F) in the heat source. The white radiation at these temperatures is intense and is hazardous to the unprotected eye. Even a short exposure is certain to leave an after-image on the retina that will persist for several minutes and distort both positioning and color judgement. Longer exposures will produce “arc-eye” or even permanent damage to the retina. Choosing a correct filter system requires a reasonable compromise between filtering out all possible dangerous radiation and leaving enough intensity and color to enable the operator to judge position, temperature, and the condition of the piece of the jewelry being heated. Platinum sections are likely to be lightweight, but they are melted at even higher temperatures than steel. Grade 5/GW (Shade 5, gas welding) filters can be used for short work periods when soldering platinum alloys, but choose at least grade 6/GW when using the highest temperature platinum

solders for longer periods. BS679 9EW, or its international equivalent (Shade 9, electric welding), to 11EW filter glasses, should be used for long welding exposures.

Although perhaps less dangerous to the eye itself, the infrared component of high temperature flames also needs to be guarded against. While an occasional short exposure to the skin may not be harmful in itself (Personal discomfort usually quickly reminds the occasional operator that welding and soldering heat sources radiate heat very directly!), repeated or prolonged exposure is dangerous. The skin should be covered, or the head and shoulder area screened, not just the eyes.

Warning: Never try using even the densest sunglasses. At the ultraviolet end of the spectrum, they may offer some protection against general sunlight, but not against a sharp concentrated image of an arc or oxy-gas flame.

Turbo Braze Welder comes complete with chemicals, extra dryer filter and needles.



49 lbs

A



B



C



D



E

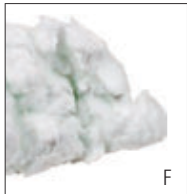

F



G



H



J



K



L



M



N

TURBO BRAZE HYDROFLUX WELDER

The Hydroflux oxyhydrogen generator operates by converting distilled water into an oxygen/hydrogen fuel gas. The Hydroflux Welder creates gas on a demand basis, this means there is no potentially saved gas. A self-contained, stainless steel, gas dryer and filter to prevent moisture and contaminants from mixing with flux and flame. You no longer have to waste fluxing compound because of frequent dumpings. Uses no exotic chemicals or formulas for its flux, has a readable distilled water usage gauge, and uses 30-gauge to 18-gauge disposable needles. Also has a stainless steel check valve to prevent flame blow-back.

Includes: chemicals, extra in-line dryer filter, 8-piece needle set, one torch, and 4ft of flexible hose. Made in the USA.

Item	Order #	Description	W x L x H	1+
A	14-1509	Turbo Braze® Welder	16" x 19" x 10"	\$1,275.00
REPLACEMENT PARTS				
B	14-1511	Torch Handle with 4 ft Hose		\$124.40
C	14-1002	Potassium Hydroxide Pellets, 10 oz		\$67.45
D	14-1500	HydroTorch Flux, 16 oz		\$13.50
E	14-1501	HydroTorch Electrolyte*, 16 oz		\$21.50
F	14-1502	Cotton Dryer Filter		\$9.30
G	14-1503	Filter for In-Line		\$11.75
H	14-1504	Filter for Handpiece		\$11.75
J	14-1505	Large O-Ring for Handpiece		\$2.50
K	14-1506	Small On/Off Ring for Valve		\$2.50
L	14-1507	Gasket		\$28.80
M	14-1508	Tubing, 12"		\$4.55
N	14-1510	Set of 9 Tips for Hydro Torch		\$5.00

* HydroTorch Electrolyte hazardous, ships UPS Ground only.



REDI-PRONG VACUUM APPLICATION SYSTEM

Once jewelers use Redi-Prongs® they never go back to conventional methods for retipping prongs. This is what makes the vacuum system such an effective tool. It increases productivity. You can pay for the system with just a few retipping jobs. Can be used with torch or laser welder applications. Includes: one high power vacuum unit, one vacuum application handpiece, two niobium fire tools, three stainless applicator tips, two easy application dispensers, and 250 Redi-Prongs.

Item	Order #	Description	1+
A	57-7770	Vacuum Application System	\$295.00
B	54-1115	Soldering Pad	\$49.75
C	54-1116	Application Handpiece	\$54.75
	54-1117	Niobium Fire Tools	\$4.85
	54-1118	Applicator Tips	\$4.85
	54-1119	Parts TMY	\$6.00
	54-1121	Replacement Vacuum Pump	\$225.60
	54-1122	Prong Dispenser	\$147.90



REDI PRONGS KIT

Item	Order #	Description	1+
D	2305	Round Retipping Kit	\$321.84
E	21461	Round Retipping Kit	\$219.63
F	23406	Round Solderless Retipping Kit	\$325.02
G	23384	Solderless Retipping Kit	\$163.59
H	21459	Princess Retipping Kit	\$460.29
J	2306	Marquise Retipping Kit	\$199.47
K	21460	Baguette Retipping Kit	\$137.76
L	2770	Redi-Channel Retipping Kit	\$161.79

SOLDERING KIT

These soldering kits have the essentials tools you need to get started. With these kits you can begin to create or repair all types of jewelry. For an entire list of kit components, visit stuller.com.



M (Deluxe Kit)



N (Basic Kit)

QUATRO SOLDERPURE

Eliminate solder smoke and fumes at the source, before they migrate through the room. Three-step filtering process effectively removes smoke and fumes from soldering, wax work, solvent vapors, and rhodium plating.

Two-year factory warranty.

- Extremely quiet (52 dba)
- Casters allow mobility
- 99.9% filter efficiency
- Brushless motor, no motor maintenance
- Maintenance-friendly design, filters accessed in seconds

Specifications:

Dimensions: 12¾" W x 15¾" D x 20" H

Weight: Operating 48 lbs.

Voltage: 120/1/60 (1 amp)



Item	Order #	Description	12+	6+	1+
A	47-4089	SolderPure Soldering	—	—	\$1,195.00
	47-4099	SolderPure Rhodium-Plating	—	—	\$1,295.00

ACCESSORIES

B	47-4091	Odor Cartridge Filter (box of 6)	\$126.65	\$134.10	\$149.00
C	47-4216	HEPA Filter	\$126.68	\$132.19	\$137.70
D	47-4093	Odor Filter F1 Rhodium Plating	\$148.75	\$157.50	\$175.00
E	47-4094	Fume Extraction Flex Arm w/Cone	\$80.75	\$85.50	\$95.00
	47-4098	8 SolderPure Hose	\$22.91	\$24.26	\$26.95
F	47-4057	Bracket Holder	\$38.25	\$40.50	\$45.00

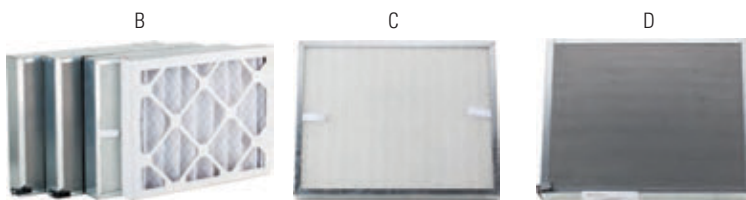
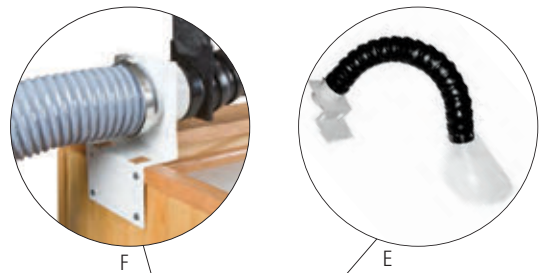

Soldering Supplies and Torches

TORCH BOOSTER

The TB-30 Torch Booster replaces acetylene, propane, and other fuel gas cylinders to provide a steady supply of 25 psi natural gas directly from your standard utility gas line. Connect your torch booster to a single torch or shop manifold. Once started torch boosters supply all the gas you need all day without further operator attention. Just turn it off at the end of the day. The TB-30 Torch Booster supplies 30cf/hr and is the right choice for jewelry casting and manufacturers with up to five bench jewelers.

- Dimensions: 12" W x 12" H x 16" D
- Operates on 110V 60Hz 15 amp power
- Use ¾" steel pipe to supply <1 psi natural gas to torch booster
- Regulator, flashback arrestor, and flexible 5' hose and shutoff valve are included

Item	Order #	Description	1+
G	54-4569	G-TEC TB-30 Natural Gas Pressure Booster Kit	\$1,999.00
	54-4567	Regulator for G-TEC Pressure Booster	\$299.00
	54-4568	Regulator Mount Flashback Arrestor Pair	\$75.00



Torch and hose not included



LITTLE TORCH CADDY KITS

Includes torch, 8 foot covered hoses, preset propane regulator, oxygen regulator, oxygen cylinder, caddy carrier, check valve, and complete instruction manual. The 14.1 disposable LP tank provides up to 12 hours of running time with a #5 tip. Also works with 14.1 disposable MAPP® tank.

Item	Order #	Description	Tip #	1+
A	14-5010	Propane Caddy	#3-7	\$499.00
B	14-5020	Acetylene	#3-7	\$575.00
C	14-5015	Propane/Oxygen	#3-7	\$640.00

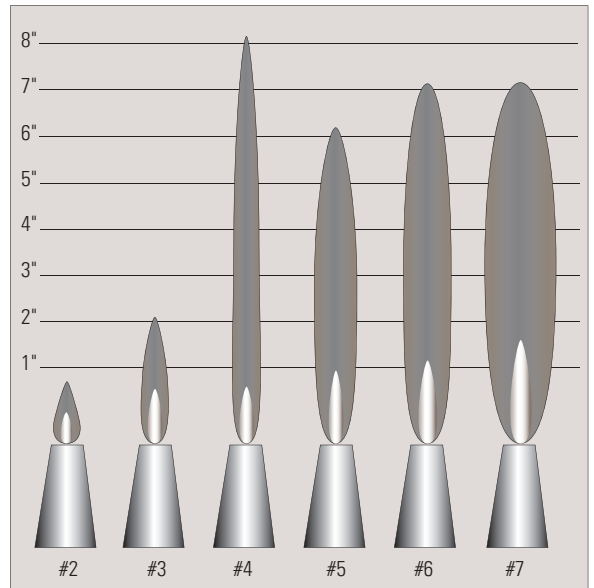

LITTLE TORCH KIT

Includes torch, 6 foot hose, curved tips, and instructions. Includes five tips in each kit. Packaged in display box. Hoses fit any standard regulator and can be used with any fuel—gas or oxygen. B (9/16") fitting.

Order #	Description	1+
14-0021	Torch kit for Propane/Natural Gas	\$135.00
14-0025	Red Replacement Valve	\$27.95
14-0025	Green Replacement Valve	\$27.95



LITTLE TORCH KIT WITH REGULATORS

Includes torch, 8 foot hose, curved tips, and instructions. Includes five tips in each kit. Packaged in display box. Hoses fit any standard regulator and can be used with any fuel—gas or oxygen.

Item	Order #	Description	1+
D	14-0022	Acetylene/Oxygen Kit	\$349.00
E	14-0024	Propane/Oxygen Kit	\$349.00

LITTLE TORCH TIP

Tip size #2 is for use with oxygen and acetylene or oxygen and hydrogen only. All others may be used with any fuel/gas.

Item	Order #	Tip Shape	Tip #	12+	6+	1+
A	14-0012	Curved	#2	\$20.83	\$22.05	\$24.50
B	14-0013	Curved	#3	\$20.83	\$22.05	\$24.50
C	14-0014	Curved	#4	\$20.83	\$22.05	\$24.50
D	14-0015	Curved	#5	\$20.83	\$22.05	\$24.50
E	14-0016	Curved	#6	\$20.83	\$22.05	\$24.50
F	14-0017	Curved	#7	\$20.83	\$22.05	\$24.50



LITTLE TORCH TIP

Item	Order #	Description	Tip #	Size	12+	6+	1+
G	14-1015	Acetylene/Hydrogen		6"	\$27.63	\$29.25	\$32.50
H	14-1016	Propane/Oxygen		6"	\$34.27	\$35.76	\$37.25
J	14-1017	Propane/Natural Gas/Oxygen		5"	\$33.15	\$35.10	\$39.00
K	14-1024	Twin Flame	#4		\$33.58	\$35.55	\$39.50
L	14-1025	Twin Flame	#5		\$33.58	\$35.55	\$39.50
M	14-1026	Twin Flame	#6		\$33.58	\$35.55	\$39.50

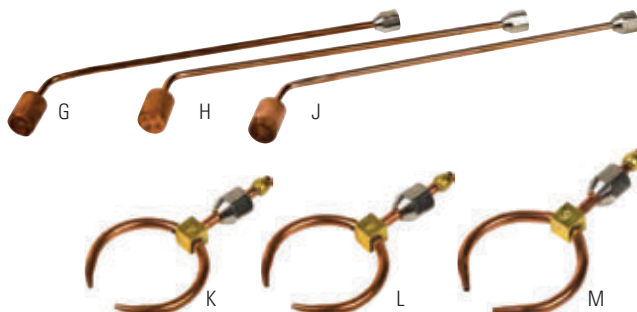

OXYGEN/GAS HOKE® TORCH

Oxygen and natural gas torch sold with three tips. Fingertip control from a large flame to a very small flame. The length of the torch is nine inches, and the openings will accommodate a 1/4" hose, item 14-0782 C-clamp connections needed.

Item	Order #	Description	12+	6+	1+
N	14-1220	Oxygen/Gas Torch	\$41.95	\$44.42	\$49.35



TIPS FOR STANDARD MODEL JEWEL HOKE® TORCH

Extra tips for oxygen/artificial gas, oxygen/acetylene, or oxygen/natural gas standard model jewel hoke torches.

Order #	Description	Flame Type	12+	6+	1+
14-1300	Oxygen/Artificial Gas	Pinpoint	\$2.55	\$2.70	\$3.00
14-1301	Oxygen/Artificial Gas	Pencil	\$2.55	\$2.70	\$3.00
14-1302	Oxygen/Artificial Gas	Small	\$2.55	\$2.70	\$3.00
14-1303	Oxygen/Artificial Gas	Large	\$2.55	\$2.70	\$3.00
14-1306	Oxygen/Acetylene	Pinpoint	\$2.13	\$2.25	\$2.50
14-1307	Oxygen/Acetylene	Pencil	\$2.55	\$2.70	\$3.00
14-1308	Oxygen/Acetylene	Small	\$2.55	\$2.70	\$3.00
14-1309	Oxygen/Acetylene	Large	\$2.55	\$2.70	\$3.00
14-1402	Oxygen/Natural Gas	Pencil	\$2.55	\$2.70	\$3.00
14-1403	Oxygen/Natural Gas	Small	\$2.55	\$2.70	\$3.00
14-1404	Oxygen/Natural Gas	Large	\$2.55	\$2.70	\$3.00

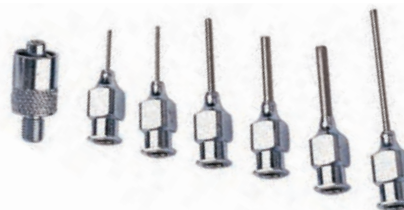

7-PIECE HOKE® ADAPTER SET

Expand the capabilities of your Hoke® torch with this adapter set. It is ideal for soldering, welding, and even melting jobs. You will be able to solder the finest of chains to the heaviest of silver hollowware. These tips will produce a non-oxidizing flame, which means less pickling, and the piece will come out with less cleanup time. The higher the number, the smaller the hole size.

Order #	Description	Tip #	12+	6+	1+
14-0600	Adapter Set with 6 Tips		\$19.81	\$20.97	\$23.30
14-0601	Adapter		\$6.12	\$6.48	\$7.20
INDIVIDUAL TIPS					
14-0602	Tip (largest)	#1	\$2.98	\$3.15	\$3.50
14-0603	Tip	#2	\$2.98	\$3.15	\$3.50
14-0604	Tip	#3	\$2.55	\$2.70	\$3.00
14-0605	Tip	#4	\$2.55	\$2.70	\$3.00
14-0606	Tip	#5	\$2.55	\$2.70	\$3.00
14-0607	Tip (smallest)	#6	\$2.55	\$2.70	\$3.00



PRIMO® FIRE RESISTANT LITTLE TORCH HOSE

Primo® fire resistant torch hoses are designed for the Little Torch™. These hoses are 1/3 lighter weight per foot and larger in diameter. Available in lengths of 6, 8, 10 and 12'.

Order #	Description	Length	12+	6+	1+
14-0527	PRIMO Torch Hose	6 ft	\$33.96	\$35.96	\$39.95
14-0527	PRIMO Torch Hose	8 ft	\$39.06	\$41.36	\$45.95
14-0527	PRIMO Torch Hose	10 ft	\$44.16	\$46.76	\$51.95
14-0527	PRIMO Torch Hose	12 ft	\$48.41	\$51.26	\$56.95



HOSE CLAMPS

Hose Clamps used for PRIMO fire resistant torch hoses.

Order #	Description	ID	12+	6+	1+
14-0751	Hose Clamp	1/8"	\$1.91	\$2.03	\$2.25
14-0751	Hose Clamp	3/16"	\$2.51	\$2.66	\$2.95



PRIMO® FIRE RESISTANT MECO TORCH HOSE

Primo® fire resistant torch hoses are designed for the Meco Midget Torch™. These hoses are 1/3 lighter weight per foot and larger in diameter. Available in lengths of 6, 8, 10 and 12' and inside diameters of 1/8" and 3/16".

Order #	Description	Length	ID	12+	6+	1+
14-0753	PRIMO Torch Hose	6 ft	1/8"	\$38.21	\$40.46	\$44.95
14-0753	PRIMO Torch Hose	8 ft	1/8"	\$44.16	\$46.76	\$51.95
14-0753	PRIMO Torch Hose	10 ft	1/8"	\$50.11	\$53.06	\$58.95
14-0753	PRIMO Torch Hose	12 ft	1/8"	\$53.51	\$56.66	\$62.95
14-0753	PRIMO Torch Hose	6 ft	3/16"	\$56.06	\$59.36	\$65.95
14-0753	PRIMO Torch Hose	8 ft	3/16"	\$63.71	\$67.46	\$74.95
14-0753	PRIMO Torch Hose	10 ft	3/16"	\$67.96	\$71.96	\$79.95
14-0753	PRIMO Torch Hose	12 ft	3/16"	\$73.91	\$78.26	\$86.95



SWISS TORCH HOSE KIT

The Swiss Torch Hose Kit includes the The Swiss Torch and the hose in the length of you choice. The hoses come in 6, 8, 10, and 12'.

Order #	Description	1+
14-1659	Swiss Torch Hose - 6' Kit	\$348.95
14-1659	Swiss Torch Hose - 8' Kit	\$355.95
14-1659	Swiss Torch Hose - 10' Kit	\$359.95
14-1659	Swiss Torch Hose - 12' Kit	\$365.95



PRIMO® FIRE RESISTANT SWISS TORCH HOSE

Primo® fire resistant torch hoses are designed for The Swiss Torch™. These hoses are 1/3 lighter weight per foot and larger in diameter. Available in lengths of 6, 8, 10 and 12' and inside diameter 3/16".

Order #	Description	Length	12+	6+	1+
14-1667	PRIMO Torch Hose	6 ft	\$50.11	\$53.06	\$58.95
14-1667	PRIMO Torch Hose	8 ft	\$56.06	\$59.36	\$65.95
14-1667	PRIMO Torch Hose	10 ft	\$63.71	\$67.46	\$74.95
14-1667	PRIMO Torch Hose	12 ft	\$67.96	\$71.96	\$79.95

READY-OX OXYGEN GENERATOR TORCH SYSTEM

The new Ready Ox System is capable of performing most any jewelry or dental soldering, brazing or heating operation with just a standard electrical wall outlet and inexpensive, clean burning propane fuel from a disposable 14 or 16 ounce tank available at most any hardware store. The torch produces a sharp 5400° F flame for pinpoint accuracy and control. The oxygen generator will provide hundreds of hours of trouble free service. Inexpensive, disposable propane tanks are capable of providing over 20 hours of service. Never again worry about running out of oxygen or the hassle of refilling your tanks. Never worry about safety issues, insurance restrictions or fire code restrictions associated with high pressure tanks. This system may be used in your home or business and is excellent for on-site repairs especially in Malls where pressurized gas cylinders are not allowed. It is easy to set up and easy to use, simply plug it in, turn on the gas, adjust the flow and light the torch.

Oxygen Generator Benefits:

- No fire code restrictions
- Safe to use indoors
- Never run out of oxygen
- Never have to travel again to a welding gas supplier for oxygen
- Never worry about high pressure oxygen tank safety issues
- Never lug around another heavy oxygen tank
- Easy to set-up and use
- Eliminate the need for an expensive high pressure oxygen regulator
- Designed to provide hundreds of hours of worry free service
- Generator plugs into any 115V home electrical service
- Capable of running two little torches



The Ready-Ox System includes the oxygen generator, a Genuine Smith Little Torch with eight foot hoses, 5-tips (sizes 3 through 7), regulator for disposable propane tank, propane tank bracket, spark lighter, reverse flow safety check valves and step-by-step set-up and operation instructions.

Item	Order #	Description	1+
A	54-4581	Torch System	\$795.00
	54-4580	Generator Only	\$469.00

PREMIUM SOLDERING PICK WITH SHIELD

This soldering tool makes your job easier. With its non-slip grip and stainless steel heat shield, you'll enjoy extended use while protecting your hands. It is made in the USA and comes with two 1/16" diameter tungsten steel tips.

Item	Order #	Description	12+	6+	1+
B	48-3000	Soldering Pick with Sheild	\$16.11	\$17.06	\$18.95
	48-3000	Replacement Tungsten Pick	\$8.46	\$8.96	\$9.95

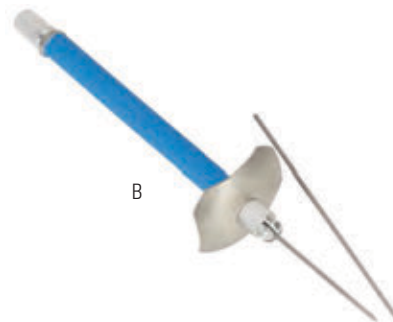

CITRIC ACID PICKLE

Natures Touch Citric Acid Pickle is a mild solution. It can be used for sterling silver, gold, brass, copper, and stainless steel. This biodegradable solution is safe, yet effective.

Order #	Description	Container Volume	12+	6+	1+
54-4600	Citric Acid Pickle	32 oz	\$11.43	\$12.11	\$13.45



GENTEC has been selling torches and welding accessories worldwide for over 60 years. The "Small Torch" regulators and other accessories are high quality, manufactured to world standards, and offer great value. Braze and solder material from the tiniest up to 1/8" thick steel. Easy manipulation in very tight spaces. Provides stable and precise concentrated feather flame adapter included. All components carry a limited two-year warranty from the factory.

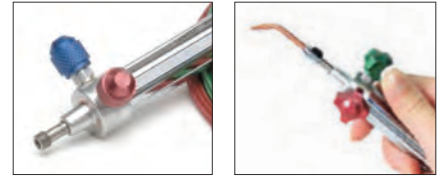

GENTEC SMALL TORCH BASIC KIT

Each basic kit contains the Small Torch handle, five tips, and 12' oxygen and fuel hoses with "B" fittings (3/16") and "A" (3/8") adapter.

Order #	Description	Tip #	12+	6+	1+
14-0758	For Oxygen/Propane	#3-7	\$110.46	\$116.96	\$129.95



GENTEC SMALL TORCH OXYGEN/PROPANE KIT

Convenient portable kit for use with disposable tanks comes complete with torch handle, #4 tip, 6-foot hoses, and preset regulators for propane and oxygen. Wire tank holder included.

Order #	Description	12+	6+	1+
14-0756	For Oxy/Propane Disposable Tanks	\$165.75	\$175.50	\$195.00



GENTEC SMALL TORCH KIT WITH REGULATORS

Contains The Small Torch handle, five tips, 12' oxygen and fuel hoses with "B" fittings (3/16"), fitting adapter "A" (3/8"), and oxygen and acetylene or propane regulators. Precision machined brass regulators feature a compact rear entry design. Chrome-plated housing caps with plastic adjustment knob for smooth "easy touch" pressure setting.

Order #	Description	Tip #	12+	6+	1+
14-0760	For Oxy/Propane	#3-7	\$246.46	\$260.96	\$289.95
14-0759	For Oxy/Acetylene	#2-6	\$237.96	\$251.96	\$279.95

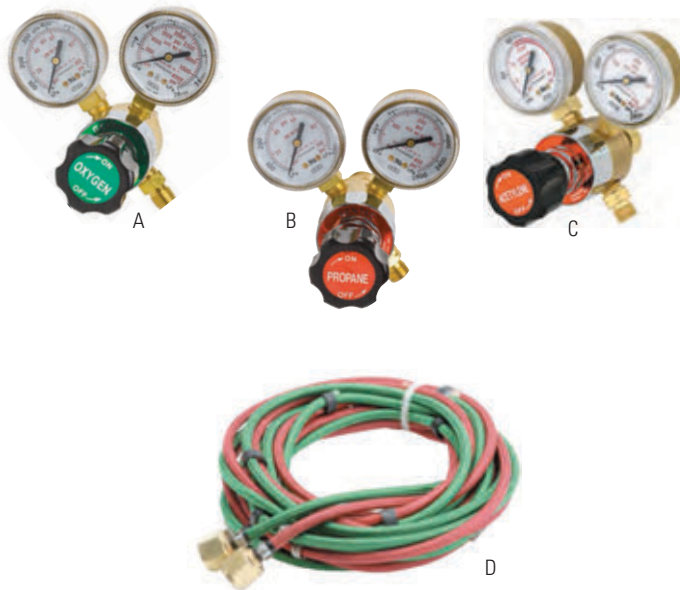

GENTEC REGULATORS

Gentec regulators are manufactured using the latest state-of-the-art equipment. With chrome-plated housing caps and body machined from class "A" brass bar stock, our regulators are single stage with rear entry construction. This compact rear mounted design allows the regulators to better fit in caddy systems and stay safely out of the way. Internal safety pressure relief valve and stem type seat assembly for more reliable seating.

Item	Order #	Description	12+	6+	1+
A	14-1630	Oxygen Regulator	\$76.46	\$80.96	\$89.95
B	14-1631	Propane Regulator	\$76.46	\$80.96	\$89.95
C	14-1632	Acetylene Regulator	\$76.46	\$80.96	\$89.95

GENTEC SMALL TORCH HOSE

Durable and flexible hoses for The Small Torch come standard with "B" fitting and include an "A" fitting adapter with each.

Item	Order #	Description	12+	6+	1+
D	14-0761	Small Torch Replacement Hose, 12'	\$41.65	\$44.10	\$49.00

THE SWISS TORCH

The most versatile, handy, lightweight, and reliable torch on the market. Use with propane and natural gas/oxygen. Not for use with acetylene. The selection of heads permit pinpoint to large flames for melting. 100% made in Switzerland.

Item	Order #	Description	12+	6+	1+
A	14-1660	Swiss Torch Body	\$101.15	\$107.10	\$119.00
B	14-1661	Micro Head w/3 Needle Nozzles	\$131.75	\$139.50	\$155.00
C	14-1662	Hoke® Standard Head	\$131.75	\$139.50	\$155.00
D	14-1663	Short Melting Head	\$97.75	\$103.50	\$115.00
E	14-1664	Long Melting Head	\$97.75	\$103.50	\$115.00
F	14-1665	Platinum Head	\$89.68	\$94.95	\$105.50

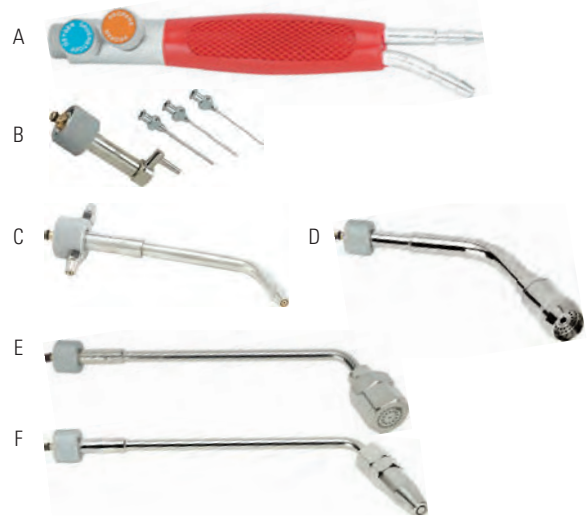

HI-HEAT TORCH

The mixing chamber of the Model D blowpipe is designed for use with natural, artificial, or bottled gas, but not for acetylene. Produces intense, perfectly formed flame. Use standard 1/2" hose with C-clamps.

Item	Order #	Description	12+	6+	1+
G	54-4535	Hi-Heat Torch	\$59.46	\$62.96	\$69.95

EXTRA TIPS

H	54-4536	Large Gas/Air Torch	\$11.86	\$12.56	\$13.95
J	54-4537	Small Gas/Air Torch	\$6.72	\$7.11	\$7.90
K	54-4538	Oxygen/Gas Torch	\$6.72	\$7.11	\$7.90



MIDGET TORCH

Small, lightweight, and ideal for jewelry welding and brazing. Control valves are conveniently positioned and hold flame adjustment precisely. Can be used with oxygen and acetylene, hydrogen, natural gas, propane, or butane. Sold with three tips and slip-on hose, with connectors for a 3/16" hose. Also fits hose 14-0783.

Item	Order #	Description	Length	Tip #	12+	6+	1+
L	14-1600	Midget Torch	6 3/4"		—	—	\$245.00

REPLACEMENT PARTS

M	14-1601	Small	#1/0	\$13.81	\$14.63	\$16.25
N	14-1602	Medium	#1	\$13.81	\$14.63	\$16.25
P	14-1603	Large	#2	\$13.81	\$14.63	\$16.25

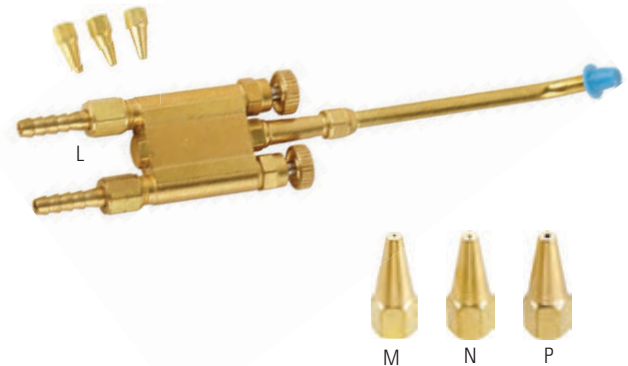

WELDING TORCHES

Top quality butane torch (14-0090) features electronic ignition (no lighter necessary), A maximum burn time of 90 minutes at 2,370°F. Easy to adjust, ensuring you have the right flame for the job. Max flame butane torch (14-0092) has a maximum output of 2,500°F and a 40% larger tank than the 14-0090. Sturdy no-tip base.

Item	Order #	Description	Height	12+	6+	1+
Q	14-0090	Butane Torch	6"	\$34.21	\$36.23	\$40.25
R	14-0092	Butane Torch	7 1/4"	\$36.00	\$38.12	\$42.35





CASTING AND MELTING TORCH

Complete with torch handle, type 17 #5 melting tip, and dual hose with A-B connections.

Order #	Description	1+
14-0755	Casting Torch	\$147.00



PLATINUM MELTING TORCH KIT

Produces a super-hot, hydrogen flame (exceeding 6,000°F.). Perfect for melting platinum as well as gold or silver. The large melting tip will melt several ounces of platinum.

Order #	Description	12+	6+	1+
14-0765	Platinum Melting Torch Kit			\$455.95

REPLACEMENT PARTS

14-5060	Smith Torch Handle	\$140.25	\$148.50	\$165.00
14-0770	Oxygen Flashback Arrestor	\$35.70	\$37.80	\$42.00
14-0771	Fuel Flashback Arrestor	\$107.23	\$113.54	\$126.15
14-0772	Hydrogen Regulator			\$122.35
14-2050	Lighter (sold with one flint)	\$2.55	\$2.70	\$3.00
14-0782	Propane/Oxygen Dual Hose	\$59.46	\$62.96	\$69.95



ACETYLENE TORCH OUTFIT

Allows mixing of acetylene with air at the torch head. No other source of air is necessary. Suitable for jewelry soldering (except small work) and melting. Supplied with four interchangeable tips that produce a range of flame sizes from small to large. Acetylene is stored in tanks as a liquid and only becomes a gas when the valve is opened. Outfit includes torch handle, four tips, a regulator for "B" tank, and a six-foot hose with fittings.

Order #	Description	12+	6+	1+
14-2350	Acetylene Torch Outfit	\$199.75	\$211.50	\$235.00



SMITH CASTING TORCHES

Smith torch handle is nickel plated. For casting platinum, gold, or silver.

Note: Flashback arrestors recommended for use with all casting torches.

UL listed with a lifetime warranty.

Item	Order #	Description	12+	6+	1+
A	14-5060	Smith Torch Handle	\$140.25	\$148.50	\$165.00
B	14-5062	Oxygen/Acetylene Tip	\$103.95	\$103.95	\$103.95
C	14-5063	Oxygen/Acetylene Heating Tip	\$84.41	\$89.37	\$99.30
D	14-5064	Oxygen/Propane Tip	\$53.98	\$57.15	\$63.50

REGULATORS

Dual stage regulators are used where a steady delivery pressure is required over a range of decreasing cylinder inlet pressures. Delivery pressures will remain constant until inlet pressure is nearly depleted. Recommended when using more than two torches. UL listed.

Item	Order #	Description	12+	6+	1+
A	14-1624	Dual Stage Oxygen Regulator	\$161.46	\$170.96	\$189.95
B	14-1625	Dual Stage Heavy Duty Oxygen Regulator	\$212.46	\$224.96	\$249.95
C	14-1626	Dual Stage Heavy Duty Acetylene Regulator	\$212.46	\$224.96	\$249.95

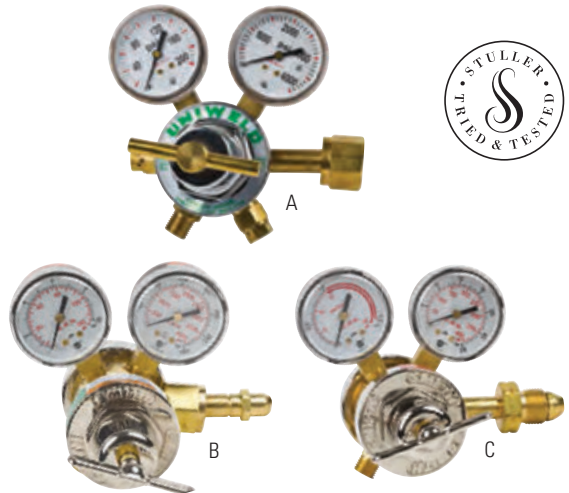

SINGLE STAGE REGULATORS

- Machined brass body, polished chrome bonnet
- Easy-to-read single scale 2½" gauges
- 2" Tri-layered reinforced neoprene diaphragm
- Heavy duty mechanical stem type seat and nozzle assembly
- Delrin bushing for smooth flow adjustment
- Fine mesh filter screen between inlet and seat
- Pressure relief device for low pressure gauge protection only
- 5½" D x 7¼" W x 6" H
- Weight: 3 lbs

Item	Order #	Description	Outlet Connection	12+	6+	1+
D	14-1607	Acetylene Regulator	"B" (LH) ¼ - 18 (M)	\$96.60	\$102.29	\$113.65
E	14-1609	Propane Regulator	"B" (LH) ¼ - 18 (M)	\$96.60	\$102.29	\$113.65
F	14-1610	Oxygen Regulator	"B" (LH) ¼ - 18 (M)	\$96.60	\$102.29	\$113.65



CHECK VALVES/FLASHBACK ARRESTORS

Stops flashback fires by preventing reverse gas flow with automatic reset between flashes. Solid brass case is durable and easy to install. Fits standard ¼" "B" connections.

Item	Order #	Description	12+	6+	1+
G	14-0769	For Fuel Gas Lines	\$35.70	\$37.80	\$42.00
H	14-0770	Oxygen Flashback Arrestor	\$35.70	\$37.80	\$42.00



CHECK VALVE

Used to help prevent dangerous reverse gas flow.

Order #	Description	OD	12+	6+	1+
14-1790	For Fuel Gas Regulator	¼ LH	\$12.45	\$13.19	\$14.65
14-1795	For Oxygen Regulator	¼ RH	\$12.45	\$13.19	\$14.65



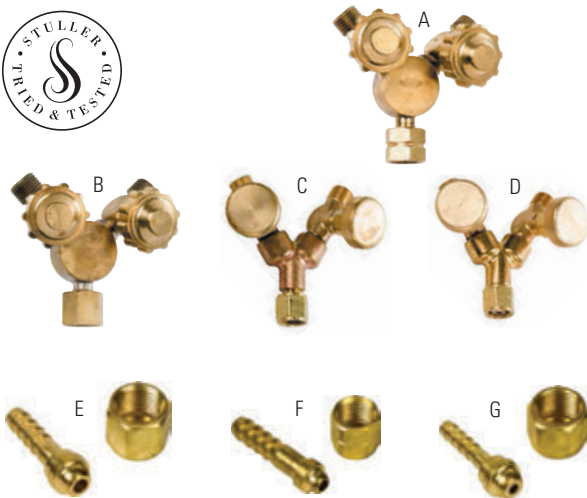

"Y" CONNECTORS

Used in multiple-torch hook-ups. With a single regulator, shut-off valve.

Item	Order #	Description	12+	6+	1+
A	14-1840	Fuel Gas 1/16" LH to 1/16" - 18 LH	\$40.85	\$42.62	\$44.40
B	14-1845	Oxygen 1/16" RH to 1/16" - 18 RH	\$40.85	\$42.62	\$44.40
C	14-1850	Oxygen Little Torch	\$50.74	\$52.94	\$55.15
D	14-1855	Fuel Little Torch	\$51.24	\$53.47	\$55.70

RIGHT-HAND THREADED CONNECTORS FOR OXYGEN

Used on regulators so that standard ID hose can be used.

Item	Order #	Description	Inside Diameter	12+	6+	1+
E	14-0777	Connection for Oxygen	9/16" - 18 1/4"	\$4.97	\$5.27	\$5.85
F	14-0778	Connection for Oxygen	9/16" - 18 3/16"	\$4.97	\$5.27	\$5.85
G	14-0779	Connection for Oxygen	3/8" - 24 3/16"	\$4.97	\$5.27	\$5.85

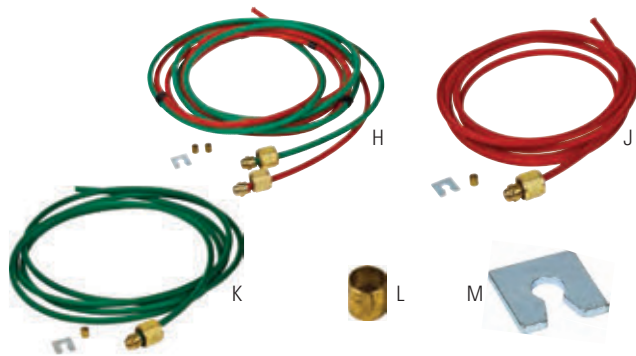

LITTLE TORCH™ HOSES AND CONNECTORS

Designed for the Little Torch™, the hoses are supplied with hose fittings and a connection tool. Hoses measure 8' length x 1/8" inside diameter. Available in single or twin hose types.

Item	Order #	Description	Type	12+	6+	1+
H	14-0524	Oxygen/Fuel Hose	Twin	\$67.96	\$71.96	\$79.95
J	14-0522	Red Fuel Gas Hose	Single	\$26.35	\$27.90	\$31.00
K	14-0523	Green Oxygen Hose	Single	\$26.35	\$27.90	\$31.00
L	14-0525	Hose Ferrule		\$7.95	\$8.41	\$9.35
M	14-0526	Crimping Tool for Hose Ferrule		\$7.95	\$8.41	\$9.35



TORCH HOSES

Twin oxygen/fuel hoses for casting and brazing torches, 3/16" diameter by 12' long. Twin fuel gas/oxygen hoses.

- R-Grade Oxygen/Acetylene Hose "B", 9/16" (14.3mm) fittings
- R-Grade Oxygen/Acetylene Hose "A", 3/8" (9.5mm) fittings
- T-Grade Oxygen/LP Hose "B", 3/16" x 12', 9/16" (14.3mm) fittings

Item	Order #	Description	12+	6+	1+
N	14-0780	R-Grade Oxygen/Acetylene B Hose	\$37.78	\$40.01	\$44.45
P	14-0781	R-Grade Oxygen/Acetylene A Hose	\$37.78	\$40.01	\$44.45
Q	14-0782	T-Grade Propane/Oxygen Dual Hose	\$59.46	\$62.96	\$69.95

WELDING TANKS

With a sturdy no-tip base, these tanks provide standard capacities for most jewelry manufacturing. Tanks are sold empty due to shipping laws.

Item	Order #	Description	Size	12+	6+	1+
R	14-5030	Oxygen Tank	20 cubic feet	\$133.72	\$139.54	\$145.35
S	14-5034	Propane Tank	5 lbs	\$98.53	\$102.82	\$107.10



REGULATORS FOR DISPOSABLE TANKS

This regulator is designed to work with disposable tanks and give a controlled flow of fuel and oxygen for the Little Torch.

Item	Order #	Description	12+	6+	1+
T	14-0410	Oxygen Regulator	\$42.50	\$45.00	\$50.00
U	14-0420	Gas Regulator	\$42.50	\$45.00	\$50.00



MAGNETIC TORCH HOLDER

Magnetic torch holder keeps your torch nearby on your bench. Heavy metal base keeps holder in place. Has holes for extra tip storage.

Item	Order #	Description	12+	6+	1+
A	14-2032	Magnetic Torch Holder	\$29.33	\$31.05	\$34.50



WEIGHTED TORCH STAND

Allows you to rest torch while working. Rod is made of stainless steel, which ensures easy placement and removal of torch without sacrificing safety. Base is made of textured cast iron. Also provides storage space for extra tips.

Item	Order #	Description	12+	6+	1+
B	14-2030	Torch Stand	\$12.54	\$13.28	\$14.75

UNIVERSAL TORCH HOLDER

Mounts to bench-top for easy access. Width 1½", height 3½".

Item	Order #	Description	12+	6+	1+
C	14-2011	Torch Holder	\$5.36	\$5.67	\$6.30



TORCH HOLDER

Mounts anywhere on bench to accommodate most torches.

Item	Order #	Description	12+	6+	1+
D	14-2010	Hook-Type Torch Holder	\$2.55	\$2.70	\$3.00

TORCH LIGHT

Produces spark to light gas without an open flame.

Item	Order #	Description	12+	6+	1+
E	14-2050	Lighter (sold with one flint)	\$2.55	\$2.70	\$3.00
F	14-2055	Lighter (sold with five flints)	\$2.13	\$2.25	\$2.50



TORCH-MATE® LIGHTER

Electric torch lighter. When the activator bar is depressed, a spark instantly lights the torch. Uses two AA batteries, not included.

Item	Order #	Description	12+	6+	1+
G	14-2040	Torch Light	\$28.26	\$29.93	\$33.25



Soldering Supplies and Torches

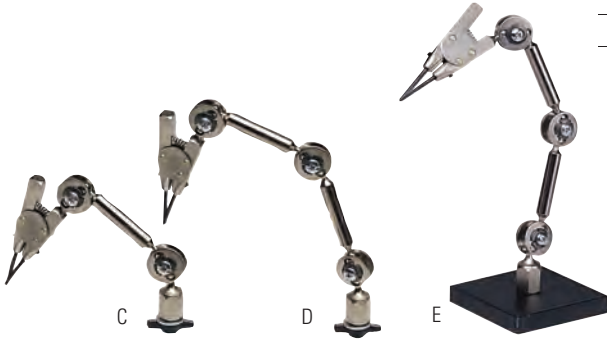

GRS® THIRD-HAND SOLDER STATIONS

Precise soldering is easy by holding parts in the exact position needed with unequalled flexibility. These third-hands can twist, rotate, and bend in all directions. GRS® Soldering Stations combine third-hands with durable non-asbestos soldering boards. These convenient packages help to reduce bench clutter and speed up soldering jobs. Sits on a bench or fits BenchMate™ fixed mounting plate.

Item	Order #	Description	W x L	12+	6+	1+
A	26-4146	Short Double Third-Hand Solder Station		\$75.65	\$80.10	\$89.00
B	26-4117	Standard Double Third-Hand Station		\$110.46	\$116.96	\$129.95

ACCESSORIES

C	26-4145	Short Third-Hand Attachment		\$32.77	\$34.70	\$38.55
D	26-4115	Standard Third-hand Attachment		\$35.10	\$37.17	\$41.30
E	26-4116	Standard Third-hand on Metal Base		\$46.71	\$49.46	\$54.95
F	26-4118	Soldering Station	6" x 6"	\$48.58	\$51.44	\$57.15
	26-4119	Soldering Station	4" x 4"	\$27.16	\$28.76	\$31.95
G	26-5118	Solder Board	6" x 6"	\$12.42	\$12.96	\$13.50
	26-5119	Solder Board	4" x 4"	\$8.19	\$8.54	\$8.90

REPLACEMENT PARTS

	26-4122	Extra Jaw		\$4.21	\$4.46	\$4.95
	26-4123	Tungsten Jaw		\$9.18	\$9.72	\$10.80
	26-4124	Replacement Spring		\$2.21	\$2.34	\$2.60

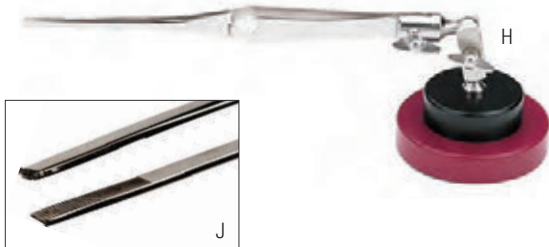
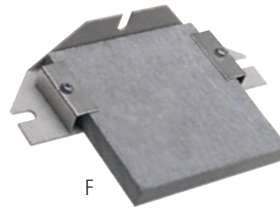

THIRD-HAND WITH TWEEZER AND ROUND BASE

Cross-locking, 6½" tweezers are mounted on a heavy, non-tipping, round base. Ball-joint attachments located on the base allow work to be positioned at any angle. Frees both hands by positioning pieces to be joined by solder or adhesive.

Item	Order #	Description	12+	6+	1+
H	54-0801	Third-Hand with Tweezer	\$12.75	\$13.50	\$15.00
J	57-7615	Blunt/Serrated Points	\$4.00	\$4.23	\$4.70



MAGNETIC THIRD-HAND BASE

Magnetic ball rotates with ease and precision. Weighing 750gm. (1¾ lb), this tool will hold your work in place. It holds 5 oz. of weight at the end of a 6" tweezer. 3" D x 3½" H dimensions, and works superbly with our straight soldering tweezer, #57-7600.

Item	Order #	Description	12+	6+	1+
K	54-4474	Third-Hand Base	\$31.83	\$33.71	\$37.45
L	57-7600	Straight Soldering Tweezers	\$4.68	\$4.95	\$5.50

DELUXE THIRD-HAND

Heavy metal base holds 6½" self-locking tweezers (included), and adjusts to all angles. Made in the USA. Shipping weight 1.2 lbs.

Item	Order #	Description	12+	6+	1+
A	54-4560	Deluxe Third-Hand	\$15.56	\$16.47	\$18.30
B	57-7600	Straight Soldering Tweezers	\$4.68	\$4.95	\$5.50



SOLDERITE™ SOLDERING PADS

Clean, long-lasting, asbestos-free solder pads made from reinforced calcium silicate. Excellent heat reflection and cools quickly without cracking or crumbling. The soft pads may be pinned, drilled, or shaped to hold components while soldering. Meets OSHA standards as an asbestos-free substitute.

Item	Order #	Description	W × L × H	12+	6+	1+
C	54-1890	Hard	6" × 6" × ½"	\$7.65	\$8.10	\$9.00
D	54-1891	Hard	6" × 12" × ½"	\$12.11	\$12.83	\$14.25
E	54-1892	Hard	12" × 12" × ½"	\$20.19	\$21.38	\$23.75
F	54-1880	Soft	6" × 6" × ¾"	\$8.46	\$8.96	\$9.95
G	54-1881	Soft	6" × 12" × ¾"	\$12.11	\$12.83	\$14.25
H	54-1882	Soft	12" × 12" × ¾"	\$20.70	\$21.92	\$24.35

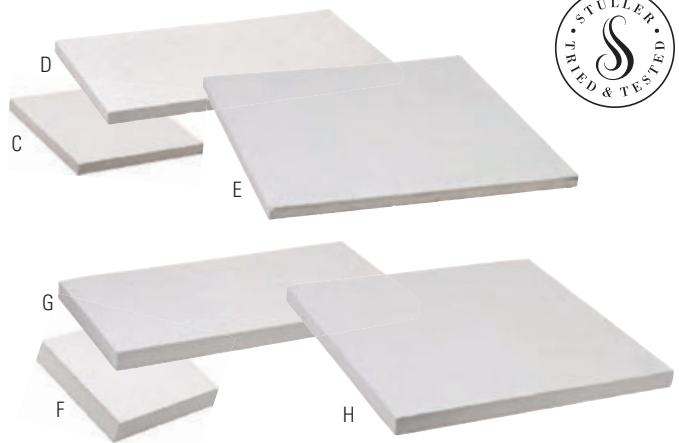

TRANSITE-SOLDERING HARD BOARDS

Durable, non-asbestos heat reflective material. Flame resistant to protect surfaces from burning. Withstands temperatures up to 2,800°F.

Item	Order #	Description	W × L	12+	6+	1+
J	54-1900	Transite Board	6" × 6"	\$12.33	\$12.86	\$13.40
K	54-1901	Transite Board	6" × 12"	\$17.43	\$18.19	\$18.95
L	54-1902	Transite Board	12" × 12"	\$34.13	\$35.62	\$37.10

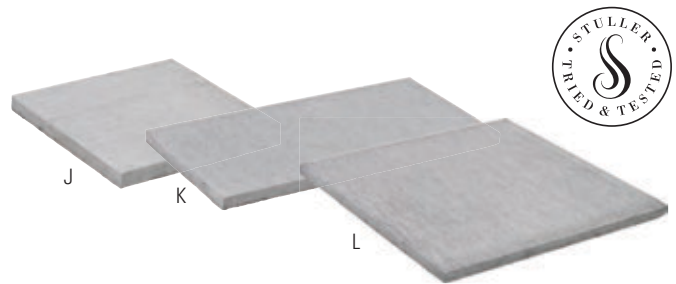

CERAMIC SOLDERING BOARDS

Tolerates temperatures of up to 2,000°F. Resistant to molten metals and most chemicals and solvents. Hard surface.

Item	Order #	Description	W × L	12+	6+	1+
M	54-1904	Ceramic Board	6" × 6"	\$11.86	\$12.56	\$13.95
N	54-1905	Ceramic Board	6" × 12"	\$17.08	\$19.22	\$21.35
P	54-1906	Ceramic Board	12" × 12"	\$23.46	\$24.48	\$25.50

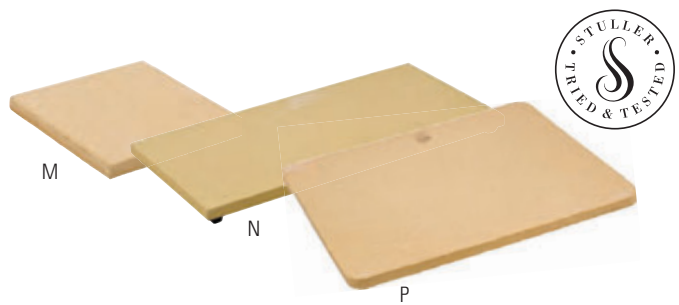

SKAMOLEX SOLDERING BOARDS

Skamolex soldering boards are lightweight, produce no fumes, and are asbestos-free. Like on charcoal blocks, the heat will remain concentrated on the jewelry pieces. They are non-combustible, though it looks like wood, it won't burn. Clean, unlike charcoal, and good to keep the workplace tidy. Tools, tweezers, picks, etc. can be inserted into these boards.

Item	Order #	Description	W × L × H	12+	6+	1+
Q	54-1910	Block	2¾" × 1⅞" × 5½"	\$3.83	\$4.05	\$4.50
R	54-1911	Round Disk	4½" × ½"	\$8.59	\$9.09	\$10.10
S	54-1912	Round Disk	5¾" × ½"	\$9.56	\$10.13	\$11.25

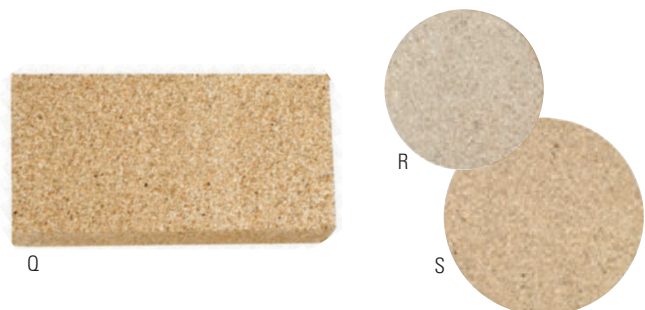



ROTATING NON-ASBESTOS SOLDERING TABLE

Lazy-Susan-style, grooved work surface disk. Rotates on ball bearings that provide 360° access. Ideal for soldering small parts.

Item	Order #	Description	OD	12+	6+	1+
A	54-1100	Soldering Table	4½"	\$23.63	\$25.02	\$27.80
B	54-1101	Replacement Disk	4½"	\$8.97	\$9.49	\$10.55



HONEYCOMB DESIGN CERAMIC SOLDERING BLOCKS

Lightweight blocks that contain hundreds of tiny holes to accelerate heat loss from parts being soldered. Holes also provide anchor points for pins or wires used to hold parts in place on the surface. Contains no asbestos. Withstands temperatures up to 2,000°F (1,093.3°C).

Item	Order #	Description	W x L x H	12+	6+	1+
C	54-1784	Soldering Block	3¾" x 5½" x ½"	\$7.76	\$8.73	\$9.70
D	54-1785	Soldering Block	5½" x 7¾" x ½"	\$11.04	\$11.97	\$13.30



HIGH-TEMP SOLDERING BLOCK FOR PLATINUM

This non-asbestos soldering board made of silquar will take temperatures up to 3,200°F (1,093.3°C).

Order #	Description	W x L x H	12+	6+	1+
54-1800	Soldering Block	4¼" x 4¼" x ½"	\$18.77	\$19.58	\$20.40



CHARCOAL SOLDERING BLOCKS

Made from select, close-grained, knot-free wood chemically prepared by a special process. The charcoal under flame creates a reducing atmosphere and reflects heat back into the work for effective soldering conditions. Heat is reflected to provide uniform intensity. Soft enough to be easily punctured to hold soldering work. Wrapping block in binding wire before use will retard cracking.

Item	Order #	Description	W x L x H	12+	6+	1+
E	54-1894	Soldering Block	2¼" x 3½" x 1½"	\$7.01	\$7.43	\$8.25
F	54-1895	Soldering Block	3" x 4¾" x 1½"	\$10.58	\$11.48	\$12.75
G	54-1896	Soldering Block	4" x 7" x 1½"	\$21.62	\$23.45	\$26.05



MAGNESIA SOLDERING BLOCK

Porous, fibrous, non-asbestos, fire-proof material used as a surface for soldering. Reflects heat and is soft enough to allow work to be pinned or pressed into the block for wireless soldering. Longer lasting than charcoal. Withstands temperatures up to 2,000°F (1,093.3°C).

Order #	Description	W x L x H	12+	6+	1+
54-1888	Soldering Block	3" x 6" x 1½"	\$4.61	\$5.00	\$5.55

DOUBLE CLAMP-ON STAND

Horseshoe-base stand with two spring-loaded clips. Ball joint attachments allow work to be positioned at any angle. Frees both hands for work. Cross-locking tweezers and other accessories may be added to increase versatility.

Order #	Description	12+	6+	1+
54-0802	Double Clamp-on Stand	\$14.15	\$14.99	\$16.65

**CERAMIC RING STAND**

Six-inch tapered, heat-resistant, ceramic mandrel holds rings in place while you solder. Mounted on base with swivel to provide the exact position or angle desired. Equipped with a clamp, which releases the rod for replacement.

Item	Order #	Description	12+	6+	1+
A	54-1108	Ring Stand	\$18.70	\$19.80	\$22.00
B	54-1109	Replacement Ceramic Rod	\$9.78	\$10.35	\$11.50

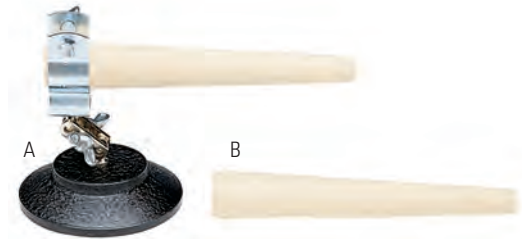
**CARBON RING STAND**

Six-inch tapered, carbon rod in fixed position on a heat-resistant (non-asbestos) base. Prevents collapse or movement when fitting shank sections together.

Item	Order #	Description	12+	6+	1+
C	54-1112	Ring Stand	\$22.78	\$24.12	\$26.80
D	54-1113	Replacement Carbon Rod	\$9.35	\$9.90	\$11.00

**SOLDERING BOX**

For tough solder jobs on earrings, rings, pendants, etc.

Order #	Description	12+	6+	1+
54-1791	Soldering Box	\$20.36	\$21.56	\$23.95

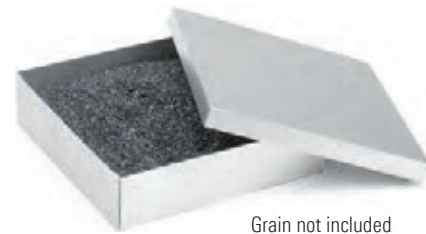
**TRIPOD WITH MESH SCREEN**

Used to solder or heat from underneath. Works with alcohol lamp or with torch and can be placed over Bunsen® burner.

Item	Order #	Description	Height	12+	6+	1+
E	14-3120	Tripod with Mesh Screen	6½"	\$11.90	\$12.60	\$14.00
F	14-3125	Replacement Mesh Screen		\$3.19	\$3.38	\$3.75

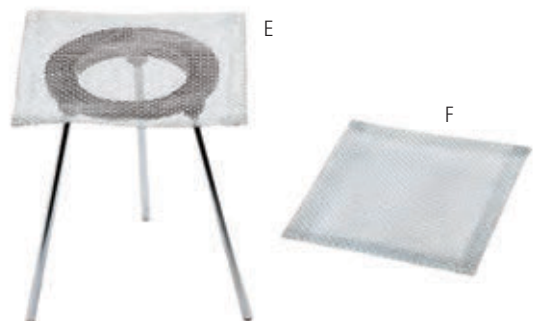



ROTATING SOLDERING PANS

Our 7 inch soldering pans rotate 360 degrees with easy access. The heat reflecting pumice is perfect for supporting your project in any position - flat or embedded. This pan comes with an attachable third hand custom designed to fit with our pans. Each pan includes pumice.

Item	Order #	Description	12+	6+	1+
A	54-1201	Soldering Pan with Attachable Third Hand	\$30.56	\$32.35	\$35.95
B	54-1200	Soldering Pan	\$25.46	\$26.96	\$29.95



ANNEALING PAN

Twelve-inch diameter pan that rotates on ball bearings, providing 360° access. Allows positioning of work while annealing or soldering on a heat-reflecting material such as pumice. 2½ lbs of lump pumice included.

Item	Order #	Description	Weight	12+	6+	1+
C	54-1104	Annealing Pan	6 lbs	\$49.47	\$52.38	\$58.20
D	54-1105	Pumice	2½ lbs	\$15.50	\$16.18	\$16.85



COOL CUP

Used to keep the stone cool while soldering. Simply fill the cup with cool water and submerge the stone and mounting while soldering. Includes special sized, negative locking tweezer, which is designed to slip on and off the post.

Order #	Description	12+	6+	1+
54-7000	Cool Cup	\$12.58	\$13.32	\$14.80



RING HOLDER FOR SOLDERING

Heavy, cast-iron base keeps holder and ring from moving during soldering. Prongs are adjustable for different size rings. Base diameter is 3" and total height is 2".

Order #	Description	12+	6+	1+
54-1120	Ring Holder	\$7.48	\$7.92	\$8.80



BINDING WIRE

Bind parts together for soldering or stringing parts to be plated. Sold in 8 oz. spools.

Order #	Description	Gauge	12+	6+	1+
43-6380	Wire	24 Gauge	\$9.06	\$9.46	\$9.85
43-6400	Wire	26 Gauge	\$7.54	\$7.87	\$8.20
43-6410	Wire	27 Gauge	\$10.63	\$11.09	\$11.55
43-6420	Wire	28 Gauge	\$10.72	\$11.18	\$11.65

TITANIUM SOLDERING PICS

Titanium machined tip, built to last. Grooved aluminum handle designed to quickly transfer heat away from the operator. Available in three colors for jobs that require different gold karats and colors. Overall length 6¼". Tip length 1⅝". Not for use with platinum.

Order #	Description	Color	12+	6+	1+
54-1817	Titanium Soldering Pick	Red	\$4.68	\$4.95	\$5.50
54-1818	Titanium Soldering Pick	Gold	\$4.68	\$4.95	\$5.50
54-1819	Titanium Soldering Pick	Blue	\$4.68	\$4.95	\$5.50

**SOLDERING PICKS**

A. **Niobium Pick:** Hardwood handle soldering picks, Niobium point soldering pick has a melting temperature of 4,474°F (2,467.8°C). Safe for platinum, silver, gold, or any other precious metal.

B. **Titanium Pick:** Wood handle with sharp-pointed tip for placing, holding, and positioning solder in just the right place. Solder will not adhere, and wood will not heat up. Not for use with platinum.

C. **Tungsten Pick:** Tungsten high-temperature soldering pick is designed specifically for platinum. This pick withstands higher temperatures than titanium and does not contaminate platinum.

Item	Order #	Description	12+	6+	1+
A	54-1810	Niobium Pick	\$6.33	\$6.71	\$7.45
B	54-1815	Titanium Pick	\$4.59	\$4.86	\$5.40
C	54-1805	Tungsten Pick	\$6.33	\$6.71	\$7.45

**FLUXIT DISPENSER BOTTLE**

Dispenser bottle with 22-gauge needle tip for applying exact amount of flux.

Item	Order #	Description	12+	6+	1+
D	54-4015	Fluxit Bottle	\$4.63	\$4.91	\$5.45

FLUX DISPENSER PUMP

This compact dispenser pump is designed to dispense the right amount of flux into the well. The one-way pump holds the fluid in the well of the cap, preventing contamination of the unused fluid. For best results and to avoid clogging, the well should be emptied and the cap cleaned between use.

Item	Order #	Description	12+	6+	1+
E	54-4035	Flux Dispenser Pump	\$22.14	\$23.45	\$26.05

**SOLVENT DISPENSER**

These dispensers have no stopper or cap to remove. Just touch the dispensing dish with a brush, cloth, or other applicator and the solvent is brought to the surface the instant it is needed. Stainless steel valves seal contents in the bottle until used, preventing spills, dripping, and escaping fumes. Fluid pumped into the dish does not drip back into the bottle, keeping stored liquids uncontaminated. Made of static dissipative plastic with Teflon tube.

Item	Order #	Description	Size	12+	6+	1+
F	54-4036	Small	120 ml	\$16.01	\$16.70	\$17.40
G	54-4037	Small Anti-Splash	120 ml	\$16.51	\$17.23	\$17.95
H	54-4038	Large	180 ml	\$16.01	\$16.70	\$17.40





FIRESCOFF®

Revolutionary spray ceramic coating that prevents oxidation and scale, acts as a flux, and features easy removal with just warm water. With Firescoff, no additional pickle flux is required, and no pickle solution is needed. Protects gemstones from heat oxidation in multiple soldering operations without waiting; consistent void-free, non-brittle, welds. Ideal for jewelry manufacturers, repair jewelers, and stone setters. Non-flammable. Odor-free, alcohol-free.

Item	Order #	Description	Size	12+	6+	1+
A	54-4413	Small Bottle	1 oz	\$9.78	\$10.35	\$11.50
B	54-4414	Large Bottle	4½ oz	\$23.89	\$25.29	\$28.10
C	54-4414	Bulk Dispenser	1000 ml bulk	\$191.41	\$199.73	\$208.05
	54-4414	Bulk Dispenser	3000 ml bulk	—	—	\$509.10



TIX® FLUX

A non-corrosive, liquid flux that works well with soft solder and has a melting temperature under 450°F (232.2°C). Harmless to skin and clothing. Washes off with water even after drying.

Item	Order #	Description	Size	12+	6+	1+
D	54-4022	Flux	½ oz bottle	\$4.23	\$4.42	\$4.60



TIX® ANTI-FLUX

Liquid that brushes on to prevent solder from flowing to unwanted areas. Used for both hard and soft soldering.

Item	Order #	Description	Size	12+	6+	1+
E	54-4024	Anti-Flux	½ oz bottle	\$3.77	\$3.94	\$4.10

TIX® SOLDER

Hardest soft solder on earth. Has a melting point of 275°F (135°C), and has a holding power of 4,300 PSI. Adheres to all ordinary, solderable materials. Works well with gun, iron, torch, or soldering machine. No cadmium or bismuth, stays white, and does not tarnish. Can be used with silver.

Item	Order #	Description	Length	Per Unit	12+	6+	1+
F	54-4050	Tix® Solder Sticks	3"	20	\$15.50	\$16.18	\$16.85

STAY-BRITE SOLDER KIT

High-strength, silver-bearing solder that melts and flows at 430°F (221.1°C). Cadmium-free and non-toxic. Provides strength without distortion caused by high temperature brazing. Retains bright silver finish after cooling. Kit contains ½ oz of solder and ½ oz flux.

Item	Order #	Description	12+	6+	1+
G	54-4020	Solder Kit	\$22.77	\$23.76	\$24.75



DANDIX® PASTE FLUX

Paste flux for use in low temperature brazing and silver soldering. Dissolves oxides at 800°F (426.7°C) and is fluid between 1,100°F and 1,600°F (593.3°C and 871.1°C). Contains no fluoride.

Item	Order #	Size	12+	6+	1+
H	54-4418	16 oz (473 ml)	\$12.62	\$13.37	\$14.85
J	54-4417	8 oz (237 ml)	\$8.41	\$8.91	\$9.90
K	54-4416	1½ oz (44 ml)	\$3.74	\$4.05	\$4.50



MAGIC BORAX™

Borax Granular powder is an excellent, general purpose flux. Excellent also for glazing clay crucibles to extend crucible life.

Item	Order #	Description	Size	12+	6+	1+
A	54-4432	Boric Acid Granular	16 oz	\$7.31	\$7.63	\$7.95



MAGIC BORIC ACID POWDER®

High-grade, superfine boric acid powder. Use as high-grade flux and deoxidizing agent. Can also be mixed with denatured alcohol to make soldering flux.

Item	Order #	Description	Size	12+	6+	1+
B	54-4433	Boric Acid Powder	16 oz	\$7.86	\$8.32	\$9.25

GRIFFITH BORAX POWDER

Used for making soldering and casting fluxes.

Item	Order #	Description	Size	12+	6+	1+
C	54-8020	Borax Powder	7 oz	\$5.00	\$5.63	\$6.25
	54-8021	Borax Powder	16 oz	\$7.20	\$8.10	\$9.00



GRIFFITH BORIC ACID POWDER

Used as an anti-oxidizer during soldering or in making flux.

Item	Order #	Description	Size	12+	6+	1+
D	54-8035	Boric Acid Powder	7 oz	\$5.19	\$5.63	\$6.25
	54-8036	Boric Acid Powder	16 oz	\$6.35	\$6.89	\$7.65

GRIFFITH BORIC ACID GRANULES

Used as an anti-oxidizer during soldering or in making flux.

Item	Order #	Description	Size	12+	6+	1+
E	54-8030	Boric Acid	7 oz	\$3.60	\$4.05	\$4.50
	54-8031	Boric Acid	16 oz	\$6.14	\$6.66	\$7.40



GRIFFLUX NO. 1

A hard-soldering paste flux for use on all ferrous and non-ferrous metals and alloys.

Item	Order #	Size	12+	6+	1+
F	54-8070	1½ oz	\$4.88	\$5.09	\$5.30
G	54-8071	8 oz	\$9.25	\$9.65	\$10.05
H	54-8072	16 oz	\$16.05	\$16.75	\$17.45



Soldering Supplies and Torches



A B C

MAGIC BORIC® SOLDERING DIP

Safe, non-flammable, longer-lasting soldering dip with built-in flux. Used for coating before soldering, no flux needed.

Item	Order #	Size	12+	6+	1+
A	54-4415	16 oz bottle	\$7.82	\$8.16	\$8.50

GRIFFITH SOFT SOLDER FLUX

For use with lead-tin and lead-tin bismuth solders that melt below 450°F.

Item	Order #	Size	12+	6+	1+
B	54-8089	4 oz bottle	\$5.06	\$5.28	\$5.50
C	54-8090	8 oz bottle	\$8.10	\$8.45	\$8.80



BATTERNS® SELF-PICKLING FLUX

Self-pickling, hard-soldering flux. For hard soldering on gold, silver, or platinum. Coat piece with this mixture of boric acid and denatured alcohol.

Order #	Size	12+	6+	1+
54-4000	1 oz bottle	\$1.87	\$2.03	\$2.25
54-4002	3 oz bottle	\$3.40	\$3.83	\$4.25
54-4004	8 oz bottle	\$3.74	\$4.05	\$4.50
54-4006	16 oz bottle	\$5.85	\$6.35	\$7.05
54-4008	32 oz bottle	\$10.75	\$11.66	\$12.95

GRIFFITH SOFT SOLDER FLUX

For use with lead-tin and lead-tin bismuth solders that melt below 450°F.

Order #	Size	12+	6+	1+
54-8080	1 oz bottle	\$2.67	\$2.78	\$2.90
54-8081	4 oz bottle	\$3.40	\$3.55	\$3.70
54-8082	8 oz bottle	\$4.55	\$4.75	\$4.95
54-8083	16 oz bottle	\$8.28	\$8.64	\$9.00



GRIFFITH PRIP'S FLUX

A liquid hard soldering flux that prevents the formation of firecoat and firescale during soldering.

Order #	Size	12+	6+	1+
54-8075	4 oz bottle	\$3.77	\$3.94	\$4.10
54-8076	8 oz bottle	\$4.69	\$4.90	\$5.10
54-8077	16 oz bottle	\$7.91	\$8.26	\$8.60
54-8078	32 oz bottle	\$11.36	\$11.86	\$12.35



MK3 PASTE SOLDER DISPENSER

Manual solder dispenser designed to deposit paste solders with pinpoint accuracy. Use with Stuller paste solders syringes.

Order #	Description	12+	6+	1+
54-4010	MK3 Solder Dispenser	\$23.76	\$25.16	\$27.95



DISPENSABLE BRAZING FLUX

This product is a concentrated general-purpose brazing flux suitable for use on gold, silver, and most non-precious metals. The product is a homogenous blend of fluxing agents and a neutral binder that has been optimized for dispensing from syringes. This product is restrictive, which means that it tends to stay in place where it is applied. This allows excellent control over flux placement, usage, and effectiveness. Also, because of the tackiness of this product, it can be used as an aid in holding solder chips in the joint area.

Order #	Description	12+	6+	1+
54-4011	Dispensable Brazing Flux	\$2.72	\$2.88	\$3.20



THERMO SHIELD

The new, revolutionary, environmentally safe, protective barrier for retarding the transfer of heat. This product will adhere to vertical, non-absorbent surfaces as well as to stones. You will no longer have to remove the stone. Dab the Thermo Shield on the area you would like to protect and hit it with the flame. No heat will transfer. Absorbs temperatures up to 3,000°F. Water soluble.

Item	Order #	Description	Size	12+	6+	1+
C	54-4030	Heat Blocker	1 lb jar	\$15.85	\$17.19	\$19.10
D	54-4031	Heat Blocker	2 lb jar	\$22.87	\$24.80	\$27.55



SOLDER PRINTS

Solder Print™ liquid formula quickly and easily exposes previously soldered joints before you heat the area, reducing work on older jewelry.

- Apply to the jewelry surface using a non-metallic applicator or flux brush: solder joints will immediately show as darker lines, so you can see exactly where previous repairs have been preformed
- Easily polish easy any joint discoloration

Order #	Description	12+	6+	1+
54-5500	Joint Detector	\$11.99	\$12.69	\$14.10



GRIFFITH ANTI-FLUX

Effectively prohibits the flow of solder to unwanted areas.

Item	Order #	Size	12+	6+	1+
E	54-4034	1 oz bottle	\$3.50	\$3.65	\$3.80



KOOL JOOL®

Protects jewels from heat damage while soldering. Unnecessary to remove jewels from settings (except opals). The jewel will stay cool if flame is used for soldering. Rinses off in plain water. Eliminates oxidizing, will not turn when heated.

Item	Order #	Description	12+	6+	1+
F	54-4026	Koool Jool®	\$7.54	\$7.87	\$8.20



GREEN STOP-OFF PEN

The most effective means to prevent solder flow. This product has been used by Stuller's own assembly department for many years. Test on a piece of paper before you solder. Shake well then use like a felt-tip marker to mask the areas where you do not want the solder to flow. Use the ultrasonic for cleaning after the solder job is complete.

Order #	Description	12+	6+	1+
54-4039	Green Stop-Off Pen	\$8.63	\$9.14	\$10.15



A



B

PRO-CRAFT® YELLOW OCHRE

When mixed with water or alcohol, yellow ochre creates a paste that is used to prevent solder flowing to unwanted areas such as previously soldered joints or the moving parts of a catch.

Item	Order #	Description	Size	12+	6+	1+
A	54-4055	Yellow Ochre	½ lb can	\$7.40	\$7.83	\$8.70



C



D

GRIFFITH YELLOW OCHRE

Mix with alcohol to produce an anti-flux for soldering.

Item	Order #	Description	Size	12+	6+	1+
B	54-4060	Yellow Ochre	2 oz jar	\$3.60	\$4.05	\$4.50

MAGIC PICKLE®

Safe pickle compound. Dry granular compound for cleaning and removing surface oxidation and firescale. Produces a clean, bright surface. Requires heat. One tablespoon to one pint liquid.

Item	Order #	Description	Size	12+	6+	1+
C	54-4431	Pickle Compound	24 oz jar	\$7.22	\$7.54	\$7.85

"BLACK MAGIC" PICKLE®

A non-acid pickle for all metals; no fumes, no corrosion, safe to use at the bench. Long lasting, not adversely affected by steel. Pre-measured dry compound shipped in a one gallon container; fill with tap water for correct pickle formulation. Saves 8 pounds of shipping cost.

Item	Order #	Description	Size	12+	6+	1+
D	54-4435	Pickle Compound	1 gallon	\$9.56	\$10.13	\$11.25

SPAREX PICKLE

Dry granular, acid compound used for pickling, cleaning, and removing surface oxidation and scale from copper and silver. This product is non-flammable and non-explosive. Requires heat.

Item	Order #	Description	Size	12+	6+	1+
A	45-1207	Pickle	2½ lb bag	\$6.67	\$6.96	\$7.25
B	45-1208	Pickle	10 oz can	\$3.63	\$3.79	\$3.95



PICKLE POT

Economical, pickle pot made for basic pickling. Well insulated with a stainless steel outer shell. Maximum temperature 150°F. Comes with plastic lid to prevent the evaporation of the pickle solution.

Order #	Description	Size	12+	6+	1+
45-3015	Pickle Pot	16 oz	\$20.87	\$22.10	\$24.55



GRIFFITH PICKLE SAFE

A dry, granular acid compound used to pickle gold, silver, and other non-ferrous metal castings.

Item	Order #	Description	Size	12+	6+	1+
C	54-5020	Pickle Safe	10 oz tub	\$4.69	\$4.90	\$5.10
D	54-5022	Pickle Safe	2½ lb tub	\$9.34	\$9.74	\$10.15



FERRIS ELECTRIC PICKLERS

Pickler which automatically keeps solution at the right temperature. This prevents solution from boiling away. Plastic basket is included which will hold articles in solution.

Item	Order #	Description	Size	12+	6+	1+
E	45-3006	Pickler	12 oz	\$99.88	\$105.75	\$117.50
F	45-3007	Replacement Basket	12 oz	\$16.24	\$17.19	\$19.10



COPPER TONGS

Used for pickling and acid solutions. Will not contaminate solutions or corrode.

Item	Order #	Description	Length	12+	6+	1+
G	57-0690	Curved Tip	8½"	\$6.38	\$6.75	\$7.50
H	57-0691	Fishtail Tip	8½"	\$6.29	\$6.66	\$7.40





A



Find added video content on Stuller.com.



B

GEMLOGIS CIEL 3-IN-1 MULTI TESTER

A. For testing and differentiating diamond, moissanite, and synthesis using thermal and electrical conductivity. The ergonomic tester is equipped with a special surface coating that ensures a comfortable grip and handling. The probe of the tester is slightly angled, allowing a more accurate and easier placement on the stone tablet. The test result is immediately displayed on the built-in LED display and also supports acoustic. Fast start and no waiting time between tests is necessary.

- For stone from 0.02 carats, any forms, loose or set spring-loaded probe (consistent pressure and protect the tip)
- Mounting collar for housing units built in
- Auto-off after 10 minutes of inactivity to conserve battery power
- Operates with three AAA alkaline batteries (not included)

PISTACHIO REFERENTIAL METER

B. Designed to further expand the analog readings displayed on the Gemlogis Ciel 3-in-1 tester and AZURE gem tester. It provides an instant, simple, and laboratory proven way to segregate diamond, moissanite and a variety of popular gemstones at an affordable price. This unique instrument communicates with the main unit, Gemlogis CIEL/AZURE, via an infrared interface that provides wireless usability.

Features:

- Three AAA NiMH rechargeable batteries (not included) and universal 110-240V charger
- Foolproof reference test disc for diamond, simulant and glass to ensure that the device provides accurate test results
- Testing size above 0.002 carats of any shape regardless of loose or mounted stones
- Batteries will last up to 80 hours of continuous usage
- Built-in power down function after 10 minutes of inactivity to maximize battery life

Item	Order #	Description	1+
A	56-7712	Multi Tester	\$263.95
B	56-7713	Referential Meter	\$168.55



Find added video content on Stuller.com.



AZURE DIAMOND TESTER

The Gemlogis AZURE electronic diamond tester distinguishes diamonds from diamond simulants. It features a fast warm-up time and provides an instant test result on loose or mounted stones. AZURE also communicates with PISTACHIO add-on tool (sold separately) via an infrared system to provide further analysis on the specific simulant or colored gemstone.

Features:

- Testing size above 0.02 carats of any shapes regardless of loose or mounted stones
- Retractable test tip designed to maintain a consistent pressure against the stones to avoid damages when excessive force is applied
- Operates on AAA alkaline batteries (included) Lasts up to two hours
- Includes carry pouch and aluminum stone rest for handling loose stones
- AZURE has a built-in power down function to maximize battery life span after 10 minutes of inactivity
- LED bar indicator:
 - GREEN = Diamond or moissanite
 - YELLOW = Metal
 - RED ZONE (Centre LED's) = Simulant indication Round
 - RED LED = Low battery warning
 - I.R = Infrared signal
 - READY = Ready for use
- Fast tip warm-up time of approximately 10 seconds
- Working temperature: 65°F to 86°F, relative humidity below 80%

Order #	Description	1+
56-7711	Diamond Tester	\$121.40



GEMORO® TESTERS

The state-of-the-art digital electronics and features make these testers the industry's most accurate, reliable and popular testers in their class.

Features:

- State-of-the-art Ultra digital electronics
- Bright white LED stone illuminator light
- Durable and protective spring-loaded retractable ULTRA probe tip
- Glowing probe tip indicator
- ULTRAgrip rubberized paint finish
- Ergonomic shape with angled probe tip
- Powered by three included user-replaceable long life NiMH rechargeable batteries. Alkaline batteries may be used in place of the NiMH rechargeable batteries if needed. May be used with GemOro® UltraDock battery charging stand accessory.
- LED bar graph/beep provides audible and visual alerts
- Auto sleep-mode function
- Protective probe tip cap and carrying case, NiMH rechargeable batteries, AC adaptor/charger, premium leatherette storage box, and loose stone holder included.
- Limited lifetime warranty

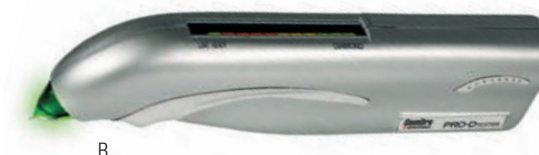

GEMORO® ULTRA TESTER II

A. Simultaneous diamond and moissanite tester that identifies, detects, and separates diamond from CZ and moissanite. Uses state-of-the-art ULTRA digital electronics, coupled with its even greater testing sensitivity make this tester the industry's most accurate, reliable, and popular combination tester in its class. GemOro sets the new standard for the ultimate protection against diamond simulant fraud.

GEMORO® PRO-D II

B. Diamond tester that identifies, detects, and separates from CZ.

GEMORO® PRO-M II

C. Moissanite tester that identifies, detects, and separates from diamond.

GEMORO® ULTRA TESTER II WITH CHARGING STATION

D. The UltraDock is a sleek, low profile battery charging stand conveniently designed for recharging the NiMH batteries used in all second generation GemOro UltraTester II, Pro-D II, and Pro-M II testers. The attractive UltraDock may be securely placed on your showroom counter, showcase, or desk with your tester inserted so that it is always within easy reach, fully charged at all times and ready for cordless or fully portable use. The testers supplied multi-voltage 100-240V AC adaptor/charger is required to power this device.



Item	Order #	Description	1+
A	56-7830	GemOro® Ultatester II	\$224.95
B	56-7831	GemOro® Pro-D II	\$119.00
C	56-7832	GemOro® Pro-M II	\$119.00
	56-7833	GemOro® Ultrapro Charging Stand	\$24.95
D	56-7835	GemOro® Ultra Tester II w/Charging Station	\$238.00
E	56-7836	GemOro® Pro-D II w/Charging Station	\$109.95
F	56-7837	GemOro® Pro-M II w/Charging Station	\$124.95



CERES DUAL XL TESTER

Differentiates between natural diamond and all common simulants, as well as moissanite. Operates on three AAA nickel-cadmium rechargeable batteries or on wall adapter.

Order #	Description	1+
56-7807	Dual XL Tester	\$229.00

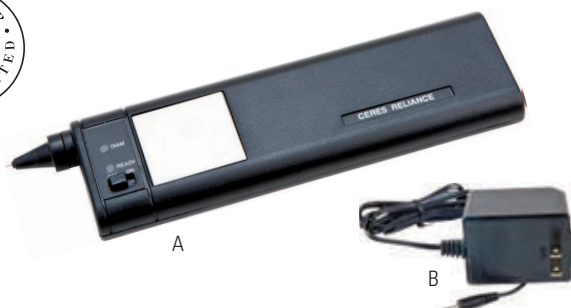

CERES RELIANCE DIAMOND TESTER

Limited warranty, does not cover tip, batteries, or adapter.

- Alkaline-battery powered
- Auto shut-off
- Spring-loaded tip
- Fast, 10-second warm up time
- Metal warning buzzer
- Requires three AA batteries
- Includes carrying case

Item	Order #	Description	1+
A	56-7804	Diamond Tester	\$135.00
B	56-7805	Adapter	\$21.15



CERES AC MODEL DIAMOND TESTER

Limited warranty, does not cover tip, batteries, or adapter.

- AC powered only, no battery
- Metal warning buzzer
- Spring-loaded tip
- Auto shut-off
- Fast, four-second, warm up time
- Loose stone holder
- Diamond/simulant test plate

Order #	Description	1+
56-7806	Reliance Diamond Tester	\$120.00



CERES CHECKPOINT DIAMOND TESTER

Limited warranty, does not cover tip, batteries, or the adapter.

- Hand-held, portable
- Spring-loaded tip
- User-replaceable, NI-CAD batteries
- Auto shut-off
- Fast, 10-second, warm up time
- Metal warning buzzer
- Audible/visual diamond indicator
- AC adapter
- Includes carrying case

Order #	Description	1+
56-7800	Checkpoint Diamond Tester	\$129.95



C3 MOISSANITE/DIAMOND TESTER

The C3 Tester is designed to differentiate between colorless and near colorless faceted diamonds and moissanite gemstones only after a thermal probe instrument test has given a "diamond" indication. The C3 Moissanite Tester is a precision fiber optic electronic instrument and must be used in a normal room environment. The C3 Tester can be wall-mounted or used on a counter surface. Operates on 120V, 60hz, and the current at 120V. AC is 0.16A.

Order #	Description	1+
56-7820	Moissanite/Diamond Tester	\$41.55

GEMORO® AURACLE AGT3 DIGITAL GOLD & PLATINUM TESTER

The NEW advanced digital AGT3 is the ultimate verification instrument for gold and platinum testing. This state-of-the-art portable handheld tester has exceptional precision, is simple to use and in seconds provides accurate results showing both the digital karat value and gold percentage

- Tests all colors of gold from 6K to 24K and tests platinum
- Alphanumeric LCD display shows both karat value and gold percentage
- Two test modes: Fast Test Yellow & Enhanced Mode
- Easy one-step calibration using either 14K or 18K yellow gold
- Scratch resistant, durable nickel plated stainless steel testing plate
- Auto-check pen probe function
- Sleek, contoured and ergonomic design
- Built-in storage compartment for pen probe
- Easy to read LCD display
- Automatic low battery indicator
- Follow easy steps to identify non-gold, gold plate and gold filled as NA
- Simply touch pen probe to filed gold or platinum and results are shown in seconds
- Replaceable pen probe provides thousands of tests with proper care
- Compact and portable
- Powered by included 9V alkaline battery or 100V-240V AC adaptor

INCLUDES: AGT3, pen probe, file, battery, AC adaptor and rubberized carrying case



Order #	Description	1+
56-7618	Digital Tester	\$549.00
56-7613	Replacement Pen	\$24.95

GEMORO AURACLE AGT-2 ELECTRONIC MOBILE GOLD AND PLATINUM TESTER

The revolutionary and best performing AuRACLE gold tester has evolved to a new generation in a mobile version that makes it faster, easier, and more convenient than ever before. Amazingly you may now use your favorite Apple iOS or Android device for testing gold and platinum!

- Works with iPhone, iPad, iPod Touch, and Android phones and tablets
- Mobile software application included
- One-touch easy pen probe calibration for consistent results
- Save results instantly for tracking testing history
- Optional downloadable iTunes or Android Apps available for increased productivity and screen customization
- World's most user-friendly, best performing handheld electronic gold tester with unmatched accuracy – PATENTED with Patents Pending
- Tests all colors of gold from 6kt to 24kt, and platinum
- Follow easy steps to identify non-gold, gold-plated and gold-filled as NA
- Simply touch pen probe to gold or platinum and read the test results on one of two dynamic displays
- Digital bar graph numerical readout, Analog meter readout
- Pen probe provides approximately 5,000 tests with proper care
- No messy gel. No staining chemicals. No dangerous acid.
- Compact and portable
- Small enough to easily fit into your pocket – No external power required
- Variable karat gold options may be used to calibrate this instrument

INCLUDES: pen probe, file, mobile device stand, testing plate, and easy to follow instructions (mobile device not included)



Order #	Description	1+
56-7602	Mobile Tester for Android/Windows Users	\$299.00
56-7602	Mobile Tester for Apple Users	\$299.00

Testers



GXL-24 PRO GOLD TESTER

State-of-the-art electronic gold testing technology that allows for the measurement of low to high karat gold products. Assures the buyer of gold content in the most critical gold alloys. UL listed. Three-year warranty. Operates on two 9-volt batteries (not included). Comes with instructional video.

Item	Order #	Description	W x L x H	1+
A	56-7630	GXL-24 Pro Gold Tester	12" x 10" x 3"	\$510.60



GT-4000 GOLD TESTER

Accurately measures white, yellow, pink, and green gold along with platinum, in a full range to 24 karat. Accurate to the nearest karat in the 6 to 18 range, plus 20, 22 and 24 karat readings. Ecologically safe, does not with not mix harmful chemicals. UL listed. Three-year warranty. - Operates on two 9-volt batteries. - Instructional video included.

Item	Order #	Description	W x L x H	1+
B	56-7635	GT-4000 Gold Tester	12" x 9" x 1¼"	\$344.80



GT-3000 GOLD TESTER

The most accurate low-cost tester available. Backed by dependable service, the GT-3000 measures white, yellow, pink, and green gold in a full range of values from 6 to 18 karat. No mixing of chemicals or fluids. UL Listed. Comes with instructional video.

Item	Order #	Description	W x L x H	1+
C	56-7640	GT-3000 Gold Tester	12" x 9" x 1¼"	\$227.15

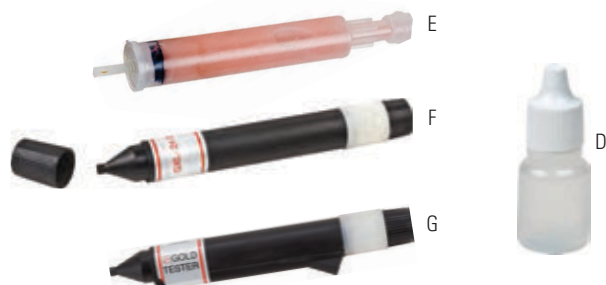

REPLACEMENTS

Item	Order #	Description	1+
D	56-7648	Pro Cleaning Solution	\$17.50
E	56-7647	Replacement Tester Gel Tube	\$21.35
F	56-7649	Replacement 24 Pro Sensor	\$59.75
G	56-7650	Replacement 4000 or 3000 Sensor	\$60.45

GXL-NEXT TESTER

The GXL-Next is the most complete electronic tester in the world. With the ability to test gold, silver, and platinum, it is the only tester you'll ever need. This tester has a full range of karat determination from 6 to 24 karats. The quick mode feature instantly test and measures yellow gold in 10, 14, 18, 20, 22, and 24 karats. Also the new mode allows for testing without the push of a button. the GXL-Next does require calibration with each use and is capable of 1000+ clear and cleaner cartridge. Our liquid testing solution is harmless and contains no toxic chemicals.

Item	Order #	Description	1+
A	56-7620	GXL-Next Tester	\$549.00
B	56-7621	Silver Testing Solution	\$18.40
C	56-7621	Gold Testing Solution	\$18.40
D	56-7622	AC/DC Power Supply	\$20.40
E	56-7622	Silver Sensor	\$51.00
F	56-7622	Sensor	\$51.00
G	56-7622	Sensor Cap	\$3.10
	56-7622	Test Wire Assembly	\$10.20
	56-7622	Plastic Test Plate with Tri Wire	\$20.40
	56-7622	Stainless Steel Test Plate with 2 Screws	\$15.30



MIZAR™ METAL TESTERS

These electronic gold testers accurately and quickly determine gold karat values of yellow, white, green and red gold shown on their LED display. These units can also help identify platinum and can distinguish non-gold or gold plate for the true karat gold. Mizar electronic gold testers are very reliable, safe, fast, portable and are very easy-to-use. Made in the USA.

- NOTE: For accuracy, all testers should be tested on a regular basis
- Uses 9 volt battery (not included)
- Sold with chemicals and has a six month shelf-life after initial opening

MIZAR™ M18A9

Determines gold karat values equal to or greater than 10kt, 14kt, 18kt gold, and helps identify platinum. The ET 18 uses a 9 volt battery and has a one-year limited manufacturer's warranty.

Item	Order #	Description	1+
H	56-7603	ET18 Gold Tester	\$114.70
J	56-7601	Replacement Chemical	\$29.15



MIZAR™ M24

Determines 9kt, 10kt, 12kt, 14kt, 16kt, 18kt, 20kt, 22kt and 24kt in seconds. Uses a 9 volt battery. Two-year limited manufacturer's warranty.

Item	Order #	Description	1+
K	56-7605	M24 Gold Tester	\$199.00
L	56-7606	Replacement Chemical	\$31.65



Testers



DELUXE TEST ACID KIT

A must for purchasing, appraising, and testing precious metals. Includes eight compartment wooden box, test acid for 10kt, 14kt, 18kt, 22kt, and silver. Also includes a gold testing star plate and a black glass testing stone.

Order #	Description	Container Volume	1+
56-0809	Deluxe Test Acid Kit		\$136.75
56-8010	10kt Gold	½ oz	\$2.70
56-8014	14kt Gold	½ oz	\$2.70
56-8018	18kt Gold	½ oz	\$2.70
56-8022	22kt Gold	½ oz	\$2.70
56-8030	Silver	½ oz	\$2.70



GOLD TESTING KIT

This scale and tester kit contains everything you need to buy and sell gold. Combine the most affordable, accurate trade legal scale on the market with a test acid kit for a lucrative profit center.

Order #	Description	1+
51-4085	A&D 1200i Scale and Metal Testing	\$319.00



GOLD TEST PRESENTATION BOX

Used to appraise and test gold, silver, platinum, brass, nickel, and German silver. Shipped in a wooden case which contains three acid bottles with ground-glass stoppers and applicators, test stones, and a set of five testing needles. Acids not included.

Item	Order #	Description	1+
A	56-0806	3 Bottle Test Kit	\$78.40
B	56-0807	8 Slot Box (only)	\$17.25
C	56-0805	Deluxe Slot Box	\$22.45



NEUTRALIZER SOLUTION

The JSP neutralizer will prepare a test stone for accurate testing and also help spare your fingers and clothes from burns and stains while using gold testing acid. Simply drop the formula onto the test stone and clean with a tissue to prevent cross contamination with previous tests. If test acid comes in contact with skin or other objects, rub the neutralizing solution on the spill to stop further damage.

Order #	Description	Container Volume	1+
56-8000	Neutralizer Solution	5 oz	\$10.10

ACID BOTTLES

Replacement bottles for holding chemicals used to test the accuracy of metals. Acids not included.

Item	Order #	Description	Container Volume	12+	6+	1+
A	56-9000	Square Acid Bottle	½ oz	\$5.43	\$5.66	\$5.90
B	56-9001	Round Acid Bottle	1½ oz	\$19.27	\$20.11	\$20.95



TEST STONES

Used for testing the karat value of gold. Rub the article to be tested and a test needle on the stone and apply a test solution to determine karat value.

Item	Order #	Description	W x L x Thickness	12+	6+	1+
C	56-7100	Stone	1½" x 2" x 1½"	\$12.92	\$13.68	\$15.20
D	56-7140	Genuine Arkansas	1½" x 2½" x ¼"	\$17.68	\$18.72	\$20.80
E	56-7101	Natural River Danube	1½" x 2½" x ¼"	\$11.22	\$11.88	\$13.20
F	56-7102	Black Glass	1½" x 2½" x ⅜"	\$4.68	\$4.95	\$5.50

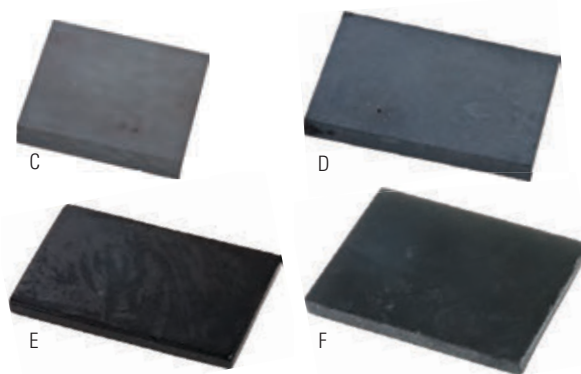

TEST STONES

Larger test stones used for determining the karat value of articles being tested.

Item	Order #	Description	W x L x Thickness	12+	6+	1+
G	56-7130	Glass Test Stone	3" x 6" x ⅜"	\$16.66	\$17.64	\$19.60
H	56-7131	Natural Test Stone	4" x 6" x ⅜"	\$23.80	\$25.20	\$28.00

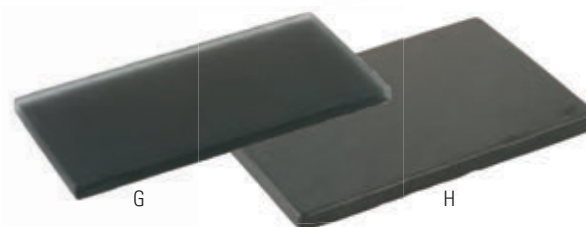

RARE EARTH MAGNET

Check for base metal (non-precious metals containing nickel or iron). Most items attracted by a magnet will not contain precious metal and most refiners will not accept them when you want to sell gold or silver. Neodymium magnets are brittle and can be broken or can splinter. One should wear gloves and protective glasses when handling these magnets. Magnets will lose their magnetic properties if heated above 175°F (80°C).

Order #	Description	W x L x H	12+	6+	1+
56-8001	Rare Earth Magnet	½" x 2" x ⅛"	\$9.35	\$9.90	\$11.00



6 PIECE TEST NEEDLE SET

Includes: 1- 8kt, 1- 10kt, 1- 12kt, 1- 14kt, 1- 18kt, 1- 999S. Test needle pricing can change with the metal market.

Order #	Description	1+
56-7006	Test Needle Set	\$47.00



GOLD TEST STAR PLATE

Solid gold tips that can be used to test for 10kt, 14kt, 18kt, 21kt, and 22kt gold as well as silver. Measures 2¼" in diameter and is provided in a fitted case.

Order #	Description	12+	6+	1+
56-7007	Test Plate	\$72.25	\$76.50	\$85.00





LAVAQUE HEAD AND SHANK TWEEZER

The LaVaque locking tweezer allows the user to accurately align the ring shank with the head. The heat resistant, replaceable glass allows the user to view all angles for perfect alignment. The glass is not intended for high heat, such as welding or platinum soldering.

Order #	Description	12+	6+	1+
57-6001	Head and Shank Tweezer	\$23.76	\$25.16	\$27.95
57-6002	Glass Lens for LaVaque Tweezer	\$6.16	\$6.53	\$7.25

ideal-tek



IDEAL-TEK STAINLESS STEEL LOCKING TWEEZERS

Made of stainless steel, these tweezers feature serrated tips and handles as well as a locking system.

Item	Order #	Tip	Length	12+	6+	1+
A	57-6188	Fine	6¼"	\$18.66	\$19.76	\$21.95
B	57-6189	Medium	6¼" Grooved	\$18.66	\$19.76	\$21.95
C	57-6190	Fine	6¼"	\$22.48	\$23.81	\$26.45
D	57-6191	Medium	6¼" Grooved	\$22.48	\$23.81	\$26.45
E	57-6192	Fine	6¼" Grooved	\$18.66	\$19.76	\$21.95
F	57-6193	Fine	6¼" Grooved	\$22.48	\$23.81	\$26.45

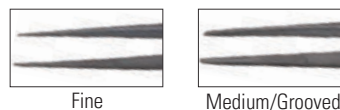

ideal-tek



IDEAL-TEK STAINLESS STEEL NON-LOCKING TWEEZERS

Made of stainless steel, these tweezers offer serrated tips and handles.

Item	Order #	Tip	Length	12+	6+	1+
G	57-6182	Fine	6¼"	\$14.83	\$15.71	\$17.45
H	57-6183	Fine	6¼" Grooved	\$14.83	\$15.71	\$17.45
J	57-6184	Medium	6¼"	\$14.83	\$15.71	\$17.45
K	57-6185	Medium	6¼" Grooved	\$17.72	\$18.77	\$20.85
L	57-6187	Medium	6¼" Grooved	\$18.66	\$19.76	\$21.95

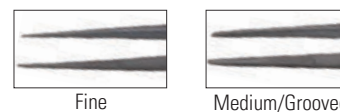

DUMONT DIAMOND TWEEZERS

The Swiss-made Dumont® Diamond tweezers have finely serrated jaws to hold stones and small objects firmly. They offer an improved locking system, a superb finish, and balance with the legendary Dumont® flexibility.

Item	Order #	Tip	Metal Type	Length	12+	6+	1+
A	57-6025	Fine	Stainless Steel	6½"	\$28.90	\$30.60	\$34.00
B	57-6026	Fine	Black Matte	6½"	\$28.90	\$30.60	\$34.00
C	57-6027	Medium	Stainless Steel	6½"	\$28.90	\$30.60	\$34.00
D	57-6028	Medium	Black Matte	6½"	\$26.35	\$27.90	\$31.00
E	57-6029	Fine Locking	Stainless Steel	6½"	\$30.60	\$32.40	\$36.00
F	57-6030	Fine Locking	Black Matte	6½"	\$33.41	\$35.37	\$39.30
G	57-6031	Medium Locking	Stainless Steel	6½"	\$34.68	\$36.72	\$40.80
H	57-6032	Medium Locking	Black Matte	6½"	\$33.41	\$35.37	\$39.30
J	57-6033	Medium w/ Groove	Stainless Steel	6½"	\$30.56	\$32.35	\$35.95



Fine



Medium/Grooved

**GENUINE SWISS DIAMOND TWEEZERS**

Self-locking tweezers. Available in black or matte stainless steel finishes.

Item	Order #	Tip	Metal Type	Length	12+	6+	1+
K	57-6050	Fine	Stainless Steel	6"	\$39.06	\$41.36	\$45.95
L	57-6060	Medium	Stainless Steel	6"	\$36.51	\$38.66	\$42.95

**TITANIUM DIAMOND TWEEZERS**

Superb quality with serrated points allows the handling of stones with ease. Very light and sensitive.

Item	Order #	Tip	Length	12+	6+	1+
M	57-6250	Medium	6"	\$50.41	\$53.37	\$59.30
N	57-6260	Fine	6"	\$49.51	\$52.43	\$58.25



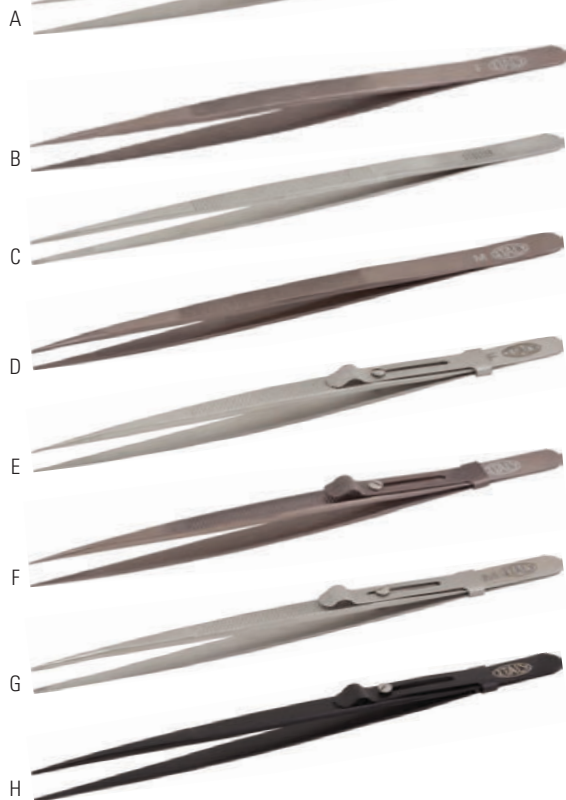

SWISS DIAMOND TWEEZERS

High quality reasonably priced diamond tweezers equal to the quality of more expensive brands. Available in black or matte stainless finish. Made in Italy.

Item	Order #	Tip	Metal Type	Length	12+	6+	1+
A	57-6052	Fine	Stainless Steel	6½"	\$10.41	\$11.03	\$12.25
B	57-6072	Fine	Black SS	6½"	\$11.48	\$12.15	\$13.50
C	57-6062	Medium	Stainless Steel	6½"	\$10.41	\$11.03	\$12.25
D	57-6082	Medium	Black SS	6½"	\$11.48	\$12.15	\$13.50
E	57-6085	Fine Locking	Stainless Steel	6½"	\$11.48	\$12.15	\$13.50
F	57-6086	Fine Locking	Black SS	6½"	\$13.18	\$13.95	\$15.50
G	57-6087	Medium Locking	Stainless Steel	6½"	\$11.48	\$12.15	\$13.50
H	57-6088	Medium Locking	Black SS	6½"	\$13.18	\$13.95	\$15.50



RUSHIT INOX TWEEZER

These tweezers are made of a lightweight steel making working with them comfortable for long periods of time. The tweezers feature finely grooved tips to enable a good grip on the diamonds when picking and holding them.

Item	Order #	Description	12+	6+	1+
J	57-6040	Extra-Fine Grip	\$7.23	\$7.65	\$8.50
K	57-6041	Fine Grip	\$7.23	\$7.65	\$8.50
L	57-6042	Medium-Fine Grip	\$9.78	\$10.35	\$11.50
M	57-6043	Large Grip	\$9.78	\$10.35	\$11.50



DIAMOND TWEezer WITH SCOOP

Fine serrated points, ribbed shanks.

Order #	Description	Length	12+	6+	1+
57-7660	Tweezers with Scoop	7"	\$3.36	\$3.56	\$3.95

ideal-tek

**IDEAL-TEK TITANIUM TWEEZERS (NON MAGNETIC)**

These tweezers are handcrafted to perfect tip symmetry and balance, with polished edges and superior no-scratch/antiglare satin finish. The right tweezers and material make for a successful application.

Item	Order #	Shape	Tip	Length	Style	12+	6+	1+
A	57-6150	Straight	Fine	4¾"	#1	\$24.44	\$25.88	\$28.75
B	57-6151	Extra Sharp	Fine	4¼"	#3C	\$24.44	\$25.88	\$28.75
C	57-6152	Sharp	Fine	5"	AA	\$16.11	\$17.06	\$18.95

**IDEAL-TEK PRECISION TWEEZERS**

Made of anti-magnetic, anti-acid stainless steel, these tweezers have strong, thick flat edges and a superior finish. Made of chromium, nickel, and molybdenum with low carbon content. Applications include watch making, jewelry, and moderate chemical environments.

STAINLESS STEEL

Item	Order #	Description	Tip	Length	Style	12+	6+	1+
D	57-6161	Strong Flat Edge		4¾"	#00	\$17.72	\$18.77	\$20.85
E	57-6163	Short		4¼"	#3C	\$17.72	\$18.77	\$20.85
F	57-6164		Extra Fine	4¼"	#5	\$18.66	\$19.76	\$21.95
G	57-6165	Curved	Extra Fine	4½"	#7	\$20.53	\$21.74	\$24.15
H	57-6160		Extra Fine	5½"	SS	\$17.72	\$18.77	\$20.85
J	57-6180	Anti-Magnetic/Anti-Acid		5"	AA	\$9.27	\$9.81	\$10.90
K	57-6181	Anti-Magnetic/Anti-Acid		5"	MM	\$9.27	\$9.81	\$10.90

INOX STEEL

Item	Order #	Description	Tip	Length	12+	6+	1+
L	57-6194	Diamond	Extra Fine	6¼"	\$20.61	\$21.83	\$24.25
M	57-6195	Diamond	Fine	6¼"	\$20.61	\$21.83	\$24.25
N	57-6196	Diamond	Medium	6¼"	\$20.61	\$21.83	\$24.25
P	57-6197	Diamond	Large	6¼"	\$20.61	\$21.83	\$24.25
Q	57-6198	Diamond	Extra Large	6¼"	\$20.61	\$21.83	\$24.25

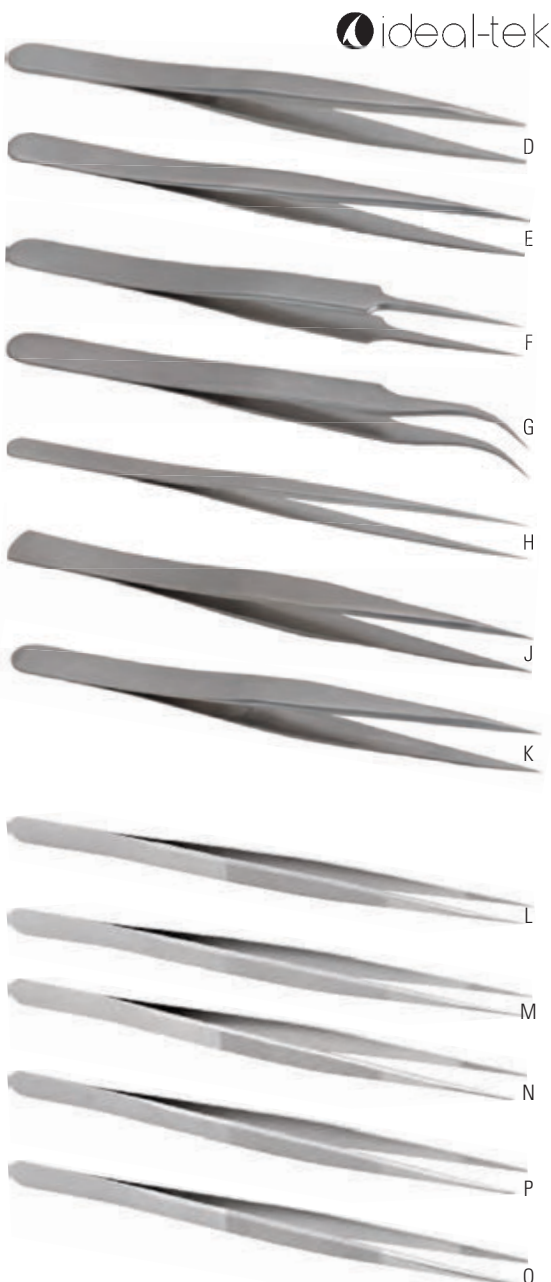



IDEAL-TEK SUPER ALLOY TWEEZERS

Made of chromium, nickel, and molybdenum super alloy, these tweezers offer strong, flat, accurate tips and a superior finish. Application includes aggressive chemical, salt, and acid environments.

- Excellent strength up to 800°C
- Excellent corrosion resistance to most chemicals
- Six times harder than anti-magnetic stainless steel
- Fully non-magnetic
- Very high, sharp extension

Item	Order #	Shape	Tip	Length	Style	12+	6+	1+
A	57-6171	Flat Edge		4¾"	#2A	\$27.16	\$28.76	\$31.95
B	57-6172	Flat Round		4¾"	#3C	\$27.16	\$28.76	\$31.95
C	57-6173	Extra Sharp	Fine	4¼"	#5	\$27.16	\$28.76	\$31.95
D	57-6174		Extra Fine	4¼"	SS	\$27.16	\$28.76	\$31.95
E	57-6170		Extra Fine	5½"	#1	\$27.16	\$28.76	\$31.95



IDEAL-TEK BRASS TWEEZERS

These tweezers offer strong, sharp tips. Made of a brass and copper zinc alloy. Good to excellent corrosion resistance. All copper alloys resist corrosion by fresh water and steam. Applications include handling scratch-sensitive parts and watch components.

Item	Order #	Tip	Length	Style	12+	6+	1+
F	57-6178	Fine	5"	#2	\$17.81	\$18.86	\$20.95
G	57-6179	Fine	4¾"	#27C	\$17.81	\$18.86	\$20.95

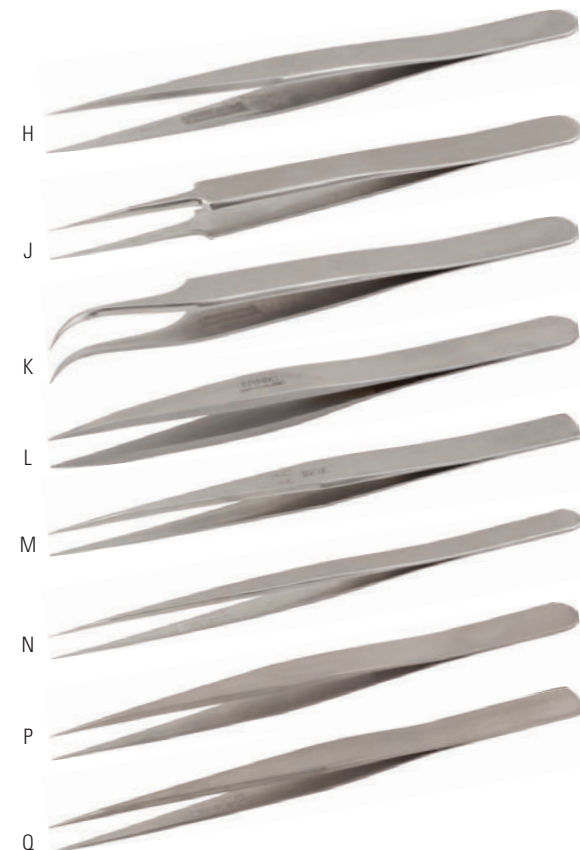

DUMONT TWEEZERS

Dumont – Finest Quality
Dumont II – Excellent Quality

Pattern #3C - Excellent for handling all miniature and micro-miniature parts. Shanks have tapered beveled edges with very sharp, honed points.

Pattern #5 - Ideal for handling microscopic parts. Needle-like shape and sharpness.

Pattern #7 - Excellent for handling all miniature and micro-miniature parts and components. Curved shanks have beveled edges and points are very sharp with a plain finish.

Pattern A - General utility tweezer used for assembly, inspection, and sorting. Thick shanks with flat edges enable the user to grip and hold the edge as well as the tip. Has plain points with wide blunt tips.

Pattern AA - Used for assembly, sorting, and soldering.

Pattern SS - Anti-acid, non-magnetic tweezer with fine, long narrow points.

Item	Order #	Description	Length	Style	12+	6+	1+
H	57-0400	Dumont® II Stainless Steel	4½"	#3C	\$30.35	\$32.13	\$35.70
J	57-5030	Dumont® II Stainless Steel	4¼"	#5	\$28.05	\$29.70	\$33.00
K	57-0420	Dumont® II Stainless Steel	4½"	#7	\$34.00	\$36.00	\$40.00
L	57-0430	Dumont® Stainless Steel	4½"	A	\$38.21	\$40.46	\$44.95
M	57-5010	Dumont® II Stainless Steel	4¾"	AA	\$22.53	\$23.85	\$26.50
N	57-0440	Dumont® Carbon Steel	4½"	SS	\$31.45	\$33.30	\$37.00
P	57-7635	Dumont® Titanium	4¾"	#3	\$32.73	\$34.65	\$38.50
Q	57-7636	Dumont® Titanium	4¾"	AA	\$30.18	\$31.95	\$35.50

SWISS PATTERN TWEEZERS SATIN FINISH

The satin soft touch provides a comfortable, non-slip grip. These tweezers provide symmetry and balance for shaping, adjusting, and finishing.

Item	Order #	Description	Length	Style	12+	6+	1+
A	57-0570	Orange Grip Non-Slip	5"	#3	\$20.19	\$21.38	\$23.75
B	57-0571	Orange Grip Non-Slip	5"	#0	\$20.19	\$21.38	\$23.75
C	57-0572	Orange Grip Non-Slip	5"	#2A	\$20.19	\$21.38	\$23.75
E	57-0573	Orange Grip Non-Slip	5"	#5	\$24.44	\$25.88	\$28.75
F	57-0574	Orange Grip Non-Slip	5"	#5A	\$24.44	\$25.88	\$28.75

**PEER VIGOR PATTERN TWEEZERS**

Boley-style tweezers are used for general utility work. Shanks are tapered and have beveled edges.

Pattern AM - Heavy brass version excellent for handling parts that scratch easily.

Pattern NN - A short tweezer for assembly, inspection, and sorting.

Pattern RR - Extra thick, heavy-duty tweezers.

Pattern AA - For assembly, inspection, sorting, soldering.

Pattern MM - Heavy-duty for assembly, sorting, and soldering.

Item	Order #	Description	Length	Style	12+	6+	1+
G	57-5035	Brass	5"	AM	\$25.50	\$27.00	\$30.00
H	57-5042	Nickel-Plated	4½"	NN	\$16.41	\$17.37	\$19.30
ECONOMY							
J	57-5015	Non-Magnetic	4¾"	AA	\$16.66	\$17.64	\$19.60
K	57-5025	Anti-Magnetic	5"	MM	\$9.35	\$9.90	\$11.00

**PEARL-HOLDING TWEEZERS**

Used to hold pearls. Tips are epoxy coated and will not damage pearls.

Order #	Description	Length	12+	6+	1+
57-6013	Holding Tweezers	5¾"	\$10.16	\$10.76	\$11.95

**BEADING TWEEZERS**

Fiber tips make these tweezers a must for handling pearls or beads. Tips will not scratch round objects being held or sorted.

Order #	Description	Length	12+	6+	1+
57-6018	Beading Tweezers	6"	\$5.53	\$5.85	\$6.50





"SOFTIE" STONE TWEEZERS

Never worry about damaging the edges of soft stones with our new "Softie" stone tweezer. It features nylon attached to a fine stainless steel shank that gives this stone handling tool a nice tooth.

Order #	Description	Length	12+	6+	1+
57-7530	Softie Stone	6½"	\$4.42	\$4.68	\$5.20



GEM HOLDER

Used to hold stones or other small items for examination. Four-prong jaws. Spring-loaded with contracting wire jaws.

Order #	Description	Length	12+	6+	1+
57-6350	Gem Holder	2¼"	\$3.36	\$3.56	\$3.95



STONE/DIAMOND POCKET HOLDER

Used to hold stones securely. Wire jaws contract into body, and plunger in end opens wire jaws. Small enough to fit in pocket.

Order #	Description	Length	12+	6+	1+
57-6015	Stone Pocket Holder	2"	\$4.76	\$5.04	\$5.60

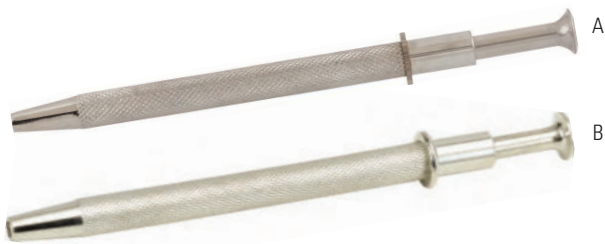

PRONGED HOLDING TWEEZERS

Used for gripping and holding small objects such as stones and diamonds. Plunger in handle opens wire jaws that contract into handle.

Item	Order #	Description	Length	12+	6+	1+
A	57-6016	3-Prong Holder	4¾"	\$4.76	\$5.04	\$5.60
B	57-6017	4-Prong Holder	4¾"	\$4.68	\$4.95	\$5.50



EASY LOOP GEM HOLDER

The Easy Loop Gem Holder gently holds delicate stones the correct way for viewing. The two prongs hold the stone by its girdle to prevent scratching.

Order #	Description	Length	12+	6+	1+
57-6021	Easy Loop Gem Holder	4½"	\$4.38	\$4.64	\$5.15



LONG SOLDER/UTILITY TWEEZERS

Heavy-duty tweezer, extra long with straight serrated points. Made of stainless steel.

Order #	Description	Length	12+	6+	1+
57-7505	Long Solder Tweezer	7"	\$4.89	\$5.18	\$5.75



SOLDERING TWEEZERS

Zirconia ceramic precision tips. Contamination-free, and high temperature (1500°C) wear and solder resistant. Stainless steel handles. Alignable replaceable tips system.

Item	Order #	Description	Length	12+	6+	1+
A	57-6200	Soldering Tweezers	4¾"	\$26.99	\$28.58	\$31.75
B	57-6201	Soldering Tweezers	4¾"	\$26.99	\$28.58	\$31.75

**HEAD AND SHANK SOLDERING TWEezer**

Slide-locking, stainless steel tweezers with a curved, grooved tip and a flat, serrated base. Design holds setting and shank in position for easy soldering.

Order #	Description	Length	12+	6+	1+
57-6000	Soldering Tweezers	5½"	\$7.61	\$8.06	\$8.95

**RING SOLDERING TWEEZERS**

Holds ring from inside for easy soldering. Also holds two rings being soldered together as a set, which makes it ideal for wedding band sets.

Order #	Description	Length	12+	6+	1+
48-2300	Ring Soldering Tweezers	4¼"	\$4.68	\$4.95	\$5.50

**HALF-SHANK TWEezer**

Made specifically for the difficult task of holding half or quarter shanks in place while soldering with no fumbling or misalignment. Made of stainless steel with a third-hand base. Top arm of the tweezer swings out of the way when not in use.

Item	Order #	Description	12+	6+	1+
C	57-7657	Half-Shank Tweezer with Base	\$18.70	\$19.80	\$22.00
D	57-7658	Half-Shank Tweezer	\$12.96	\$13.73	\$15.25

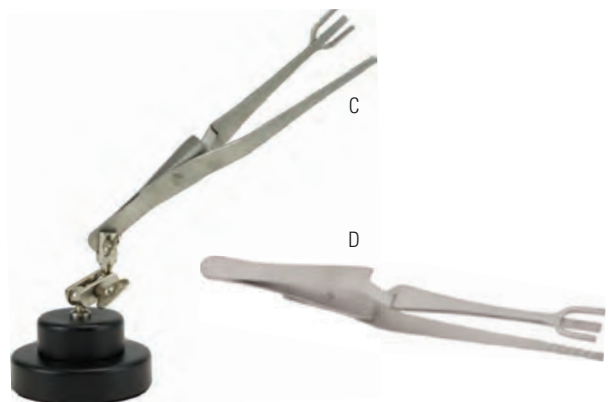
**COPPER TONGS**

Used for pickling and acid solutions. Will not contaminate solutions or corrode.

Item	Order #	Description	Length	12+	6+	1+
E	57-0690	Curved Tip	8½"	\$6.38	\$6.75	\$7.50
F	57-0691	Fishtail Tip	8½"	\$6.29	\$6.66	\$7.40





MAGNETIC THIRD-HAND BASE

Self-locking, soldering tweezers with fiber grip and heat-resistant handles.

Item	Order #	Description	Length	12+	6+	1+
A	57-7610	Curved Tweezers	6"	\$3.53	\$3.74	\$4.15
B	57-7600	Straight Soldering Tweezers	6"	\$4.68	\$4.95	\$5.50

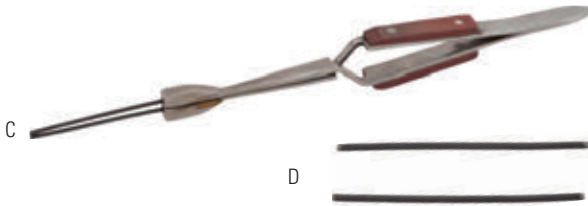

TUNGSTEN TIPPED TWEEZERS

Tungsten-tipped tweezers designed for platinum soldering. Crosslocking, fiber-grip tweezers with replaceable tungsten-carbide tips.

Item	Order #	Description	Length	12+	6+	1+
C	57-6280	Tungsten-Tipped Tweezers	8¾"	\$40.08	\$42.44	\$47.15
D	57-6281	Replacement Tips Set of 2	8¾"	\$8.29	\$8.78	\$9.75



CROSS-LOCKING REVERSE-ACTION TWEEZERS

Used to hold objects for soldering. Can also be used in a variety of general applications. When pressure is applied to the handles, tips open. Once pressure is released from the handles, tips automatically close. Made of nickel-plated steel. Excellent heat sink when soldering.

Item	Order #	Description	Length	12+	6+	1+
E	57-7615	Blunt/Serrated Points	6½"	\$4.00	\$4.23	\$4.70
F	57-7620	Sharp/Serrated Points	6½"	\$5.53	\$5.85	\$6.50
G	57-7625	Sharp Points	4¾"	\$3.83	\$4.05	\$4.50



5-PIECE SOLDER/UTILITY TWEezer KIT

Contains two self-closing general purpose tweezers and three utility/solder types in a deluxe pouch.

Order #	Description	12+	6+	1+
57-6038	Solder/Utility Kit	\$26.35	\$27.90	\$31.00



4-PIECE UTILITY TWEezer KIT

Four popular tweezers in a handy PVC pouch. The set features the following styles: 4¾" general purpose, 6½" insulated cross-locking, 6½" bent nose, and 4½" cross-locking tweezers.

Order #	Description	12+	6+	1+
57-6037	Utility Tweezer Kit	\$9.31	\$9.86	\$10.95

HEMOSTAT FORCEPS

Used as clamps when working with small articles. Made of stainless steel. Box-joint construction and serrated jaws allow firm holding. Contains three-position locking device.

Item	Order #	Description	Length	12+	6+	1+
A	46-4545	Straight Forceps	5"	\$5.74	\$6.08	\$6.75
B	46-4550	Curved Forceps	5"	\$5.53	\$5.85	\$6.50

**STEAMOSTAT**

Made of stainless steel, the Steamostat features PVC-covered tips for holding jewelry while steam cleaning.

Order #	Description	Length	12+	6+	1+
46-4555	Steamostat	8"	\$9.78	\$10.35	\$11.50

**ECONOMICAL STEAM TWEEZERS**

Chrome-plated. Chemical resistance is provided by the plastic coating on tips. Plastic coating may vary in color.

Order #	Description	Length	12+	6+	1+
57-9200	Steam Tweezers	10"	\$6.16	\$6.53	\$7.25

**COATED FORCEPS/STEAM TWEEZERS**

Used for handling items being steamed and/or cleaned in ultrasonics. Plastic coating on tips provide chemical resistance along with a firm grip for retrieving items without scratching. Made of nickel-plated steel. Plastic coating may vary in color.

Item	Order #	Description	Length	12+	6+	1+
C	57-7510	Cross-Locking	6½"	\$9.99	\$10.58	\$11.75
D	57-7515	Straight	8"	\$9.35	\$9.90	\$11.00
E	57-7516	Straight	10"	\$10.20	\$10.80	\$12.00

**BAMBOO TWEEZERS**

Tweezers made from bamboo have a gentle grip and will not damage small delicate objects. Bamboo tweezers are highly recommended for use in optical inspection and production environments. They have excellent insulation and are chemical-resistant.

Item	Order #	Description	Length	12+	6+	1+
F	57-7517	Small Pointed	6"	\$4.04	\$4.28	\$4.75
G	57-7518	Large Pointed	9¾"	\$4.21	\$4.46	\$4.95
H	57-7519	Large Flat Blunt	7"	\$4.89	\$5.18	\$5.75

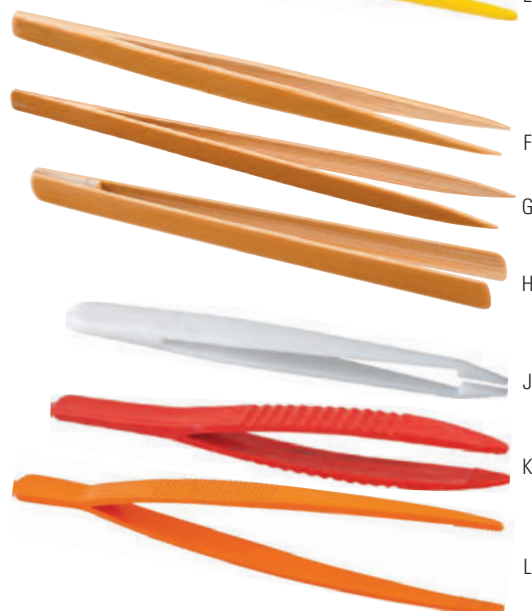
**PLASTIC TWEEZERS**

Plastic tweezers for handling watch batteries or electronic parts for watches.

Item	Order #	Color	Length	12+	6+	1+
J	57-7520	White	4½"	\$0.77	\$0.81	\$0.90
K	57-7522	Red	5"	\$1.23	\$1.31	\$1.45
L	57-7521	Orange	7"	\$1.27	\$1.35	\$1.50





SCREW-HOLDING TWEEZERS

Ideal for battery clamps and screws, the v-shaped notch makes it possible to hold the smallest screws for assembly.

Order #	Description	Length	12+	6+	1+
57-7525	Screw-Holding Tweezers	4 7/8"	\$9.35	\$9.90	\$11.00



SPLIT RING TWEEZERS

An easy-to-use tweezers for opening small to medium split rings. Just put the split ring under the claw and squeeze. The tweezers is made of stainless steel.

Order #	Description	Length	12+	6+	1+
57-7640	Split Ring Tweezers	4 1/2"	\$4.21	\$4.46	\$4.95



ECONOMY BOLEY STYLE TWEezer

General-utility tweezers for handling miniature parts. Heavier than style AA. Shanks are slightly longer, and the corner of the handle is rounded.

Order #	Description	Length	12+	6+	1+
57-5020	Boley Style Tweezer	5"	\$3.40	\$3.60	\$4.00



SMALL SOLDERING/UTILITY TWEezer

Heavy-duty tweezers with beveled edge. Points are sharp and beveled. Made of nickel-plated steel.

Order #	Description	Length	12+	6+	1+
57-7500	Soldering/Utility Tweezer	4 3/4"	\$4.59	\$4.86	\$5.40

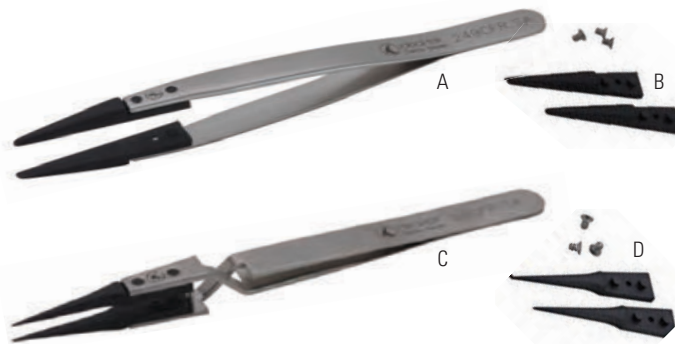

IDEAL-TEK ANTI-ACID STAINLESS TWEezer

Handcrafted to perfect tip symmetry and balance, polished edges, superior no-scratch/antiglare satin finish. The right tweezers and material for a successful application.

Item	Order #	Description	Length	12+	6+	1+
A	57-7302	Tweezer with Strong Tips	5"	\$18.57	\$19.67	\$21.85
B	57-7303	Replacement Tips for 57-7302		\$5.61	\$5.94	\$6.60
C	57-7304	Tweezer with Very Fine Tips	5"	\$21.68	\$22.95	\$25.50
D	57-7305	Replacement Tips for 57-7304		\$5.61	\$5.94	\$6.60



JEWEL PICKERS

The Jewel Picker is the ultimate tool for jewelry making, beading, stone setting, etc. This unique item was designed to replace sticky wax as a means to pick up stones to place them in a setting during the stone setting operation. The advantage of using this stick is that you can place your item with pin-point control. No more struggling with tweezers. When tip becomes dirty, just use steam, wash with warm water, or simply roll on adhesive tape to clean it up.

Item	Order #	Description	12+	6+	1+
E	57-0451	Small	\$8.20	\$8.69	\$9.65
F	57-0450	Medium	\$8.20	\$8.69	\$9.65



A



B



C



D

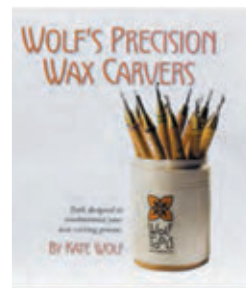

E

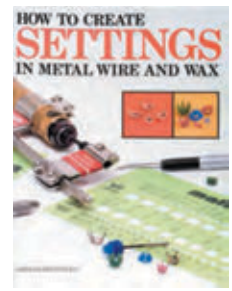

F

Item	Order #	Title/Description	1+
A	62-4511	Practical Clock Repairing. By Donald de Carle, FBHI. Deals with the usual faults likely to develop in each type of movement in general use, from grandfather to alarm clocks. All tools and equipment are described and illustrated, along with information on proper use. With 400 illustrations. Hardcover, 240 pages.	\$53.20
B	62-4514	Practical Watch Repairing. By Donald de Carle, FBHI. This book contains 550 illustrations describing the theories and processes of repairing and adjusting the modern watch precisely and with meticulous detail. Hardcover, 299 pages.	\$17.60
C	62-4513	Repairing Clocks & Watches. By Anthony Whiten. Geared for the less affluent collector. Concentrates on the more common timepieces available and how to deal with each component, suggesting original short cuts and ingenious ideas for making simple tools. Step-by-step sequences and complete movements with all important parts identified in position. High readability and originality. Hardcover, 296 pages.	\$50.95
D	62-4437	Ring Repair. By Alan Revere. This is the first of six books on jewelry repair based on Alan Revere's long running series in JCK Magazine. Follow 15 ring repairs ranging from a simple stretching job to installing a spring insert, enlarging a bi-color shank, replacing a platinum half-shank, adding an adjustable ring mechanism, and more. With 143 close-up color images, 91 sketches, and 125 pages, this book is essential for anyone doing repairs at the bench. Softcover, 125 pages.	\$70.80
E	21-0496	22-Page Instruction Booklet (only). Tools designed to revolutionize your wax carving process. Master modelmaker and educator Kate Wolf shares her 25 years of wax carving experience. Her wax carving tools are a must for you, the wax carver, to experience new techniques illustrated in her book. Softcover, 25 pages.	\$13.30
F	21-0276	Matt Creative Setting Kit. This book illustrates new and easy methods to create settings from wire and wax. This book also includes two templates for designing settings. Softcover, 33 pages.	\$35.50

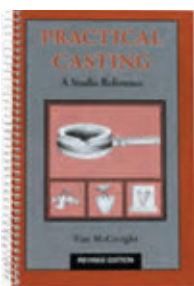

G

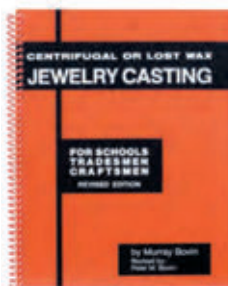

H



J



K



L



M

Item	Order #	Title/Description	1+
G	62-4440	Practical Casting. By Tim McCreight. A handy, bench reference for casters that thoroughly covers model making, spruing, investing, vacuum, and centrifugal and sand casting. It also covers unusual techniques such as steam and sling casting. A complete appendix includes charts and tables not available elsewhere. Softcover, 122 pages, spiral-bound book.	\$19.35
H	62-4432	Centrifugal or Lost Wax Jewelry Casting. By Murray Bovin. This well-illustrated book is a must for anyone who does professional work. Covers mold making, waxing, forming, investing, burnout, and casting. Also contains charts, tables, and descriptions. Softcover, 144 pages, spiral-bound book.	\$24.00
J	62-4454	Jewelry Wax Modeling. By Adolfo Mattiello. This book takes you step by step through all aspects of design, layout, and carving with Matt™ Tools. Clear instruction with more than 350 beautifully done black-and-white illustrations. This book is a must and a great value for wax designers. 161 pages.	\$59.10
K	62-4479	Wax Modeling. By Adolfo Mattiello. This is an instructional book that shows how to get the most out of the Matt-Gun and extruding technique. Softcover, 113 pages.	\$27.55
L	62-5502	Hinges and Hinge-Based Catches. Charles Lewton-Brain analyzes hinges and hinge-like mechanisms and focuses on the design of all types of pins for the many different hinges. His guiding prin ciples in each section touch on the basic hinge to the hard to make cast type hinge. Softcover, 112 pages with 200 line drawings.	\$39.55
M	62-4459	Experts Guide to Graver Sharpening. This DVD is sponsored by Sam Alfano. He will teach the professional jeweler with step-by-step close-ups of how to sharpen square, flat, and round gravers. Get the tips and tricks to engraving. DVD, 1 hour.	\$50.95

Videos and Books

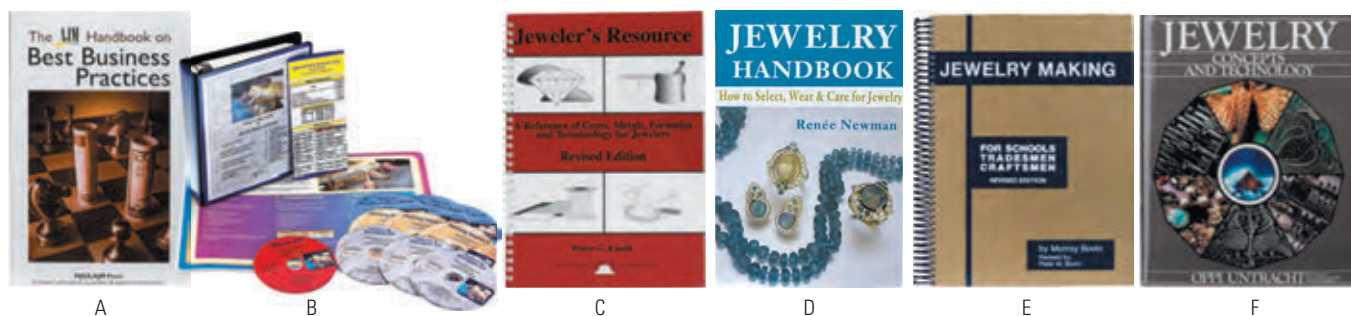

Item	Order #	Title/Description	1+
A	62-4498	<i>The AJM Handbook.</i> MJSA/AJM Press has printed expert advice on how to adapt business strategies that streamline financial control and create healthy profit margins. Softcover, 96 pages.	\$22.45
B	62-4388	<i>Gellars Blue Book Version 5.0.</i> This new Gellar's blue book set concentrates on jewelry repairs. How to set your price for repair prices and stay profitable with the sensitive customer. 1 package set.	\$423.30
C	62-4430	<i>Jewelers Resource.</i> A reference of gems, metals, formulas, and terminology for jewelers. A unique, practical tool that serves as the most complete counter reference available to the retail jeweler. Covers areas such as mathematical formulas, measurements, conversions, and comparison tables. The book offers extensive listing of gems and gem properties; diagrams of more than 40 gem-cutting styles; legal standards for diamond, gold, and silver marketing; numerous formulas and chemical preparations; and much more. Softcover, 112-page, spiral-bound book.	\$24.70
D	62-4590	<i>Jewelry Handbook.</i> Practical guide to selecting the right jewelry for your lifestyle, budget, and body type. You'll learn the benefits and drawbacks of various setting styles, mountings, chains, and metals.	\$22.45
E	62-4434	<i>Jewelry Making.</i> By Murray Bovin. Excellent book written in clear, easy to understand terms. Contains photographs and diagrams of fundamental processes and techniques such as enameling, plating, and etching. Softcover, 288-page, spiral-bound book.	\$32.15
F	62-4436	<i>Jewelry Concepts and Technology.</i> By Oppi Untracht. Excellent reference book for all jewelers. Contains 1,700 photographs that illustrate step-by-step instructions. Also contains measurement tables, conversion charts, refining procedures, quality control, plus a history of the origin of jewelry making. Hardcover, 864-page book.	\$135.00



Item	Order #	Title/Description	1+
G	62-4445	<i>The Jewelers Bench Reference.</i> This book by Harold O'Connor clearly and concisely explains all types of jewelry-making techniques. Instructions on the care and use of equipment. Contains vital information about fabricating, soldering, stone setting, plating, and casting. Could be considered a problem-solving handbook. Softcover, 67 page, spiral-bound book.	\$18.15
H	62-4463	<i>The Jewelers Bench Book.</i> In <i>The Jeweler's Bench Book</i> , acclaimed metalsmith Charles Lewton-Brain offers expert advice on how you can choose the bench that best meets your needs—then modify it for maximum efficiency. With plentiful full-color illustrations, <i>The Jeweler's Bench Book</i> covers everything from the basics of bench design to ingenious tips for tool storage and arrangement. It also includes real-life "tours" of how renowned jewelers have set up their own bench areas.	\$39.35
J	62-4482	<i>101 Bench Tips for Jewelers.</i> Bench Tips simply makes the jewelers life more productive. The tips or trade secrets cover soldering, stone setting, and final polishing. This is an everyday bench source. Softcover, 120 pages.	\$43.85
K	62-4475	<i>At The Bench.</i> By Stuller's very own experts: Gregg Todd and Greg Gilman. Double awardwinning book based on the popular AJM column of the same name, <i>At the Bench</i> offers step-by-step, illustrated instruction on the repair and fabrication of gold and silver jewelry, as well as insight into common alloys, bench preparation, safe practices for bench jewelers, and tips for taking in repairs. With more than 200 full-color photographs and countless tips, this book is destined to earn a spot near every jeweler's bench.	\$30.55
L	62-4396	<i>Adventures at the Bench.</i> Renowned platinumsmith Jurgen J. Maerz offers his best bench tricks from innovative uses for clothespins and table salt to ingenious homemade tools, as well as relates lessons learned from his earliest days as an apprentice. He also provides illustrated step-by-step guides on everything from the basics of fabricating platinum sheet, alloy, and chain to using the jeweler's newest best friend, the laser. "This book is full of clever tips, shortcuts, and homemade tools: Read through this book, and see if you aren't amazed at the information it holds," says Alan Revere, noted designer, author, and founder of the Revere Academy of Jewelry Arts.	\$39.55



A

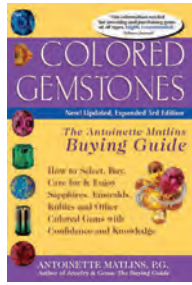

B



C

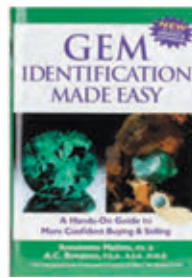

D



E

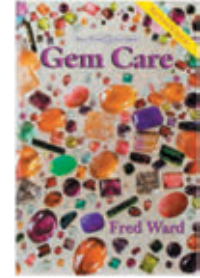

F

Item	Order #	Title/Description	1+
A	62-4465	Gemstone Buying Guide. By Renee Newman, GG. Written for both consumers and professionals in an easy-to-read format, this guide features more than 150 colored photos. A comprehensive guide to evaluating, identifying, selecting, and caring for a variety of colored gemstones. 148 pages.	\$24.50
B	62-4499	Colored Gemstone Guide Edition 3. The author, Antoinette Matlins, also wrote, <i>Jewelry & Gems</i> . This buying guide has been updated and expanded on how to select, buy, care for, and enjoy colored gems. Softcover, 199 pages.	\$24.70
C	62-4497	Working with Gemstones. Author's Arthur Skuratowicz and Julie Nash share their insights on how to work on gem-set jewelry. The book discusses the various gemstones that react to heat and pressure, mountings modifications, and what tools to use for the different characteristics of the gemstones being mounted. Softcover.	\$37.25
D	62-4467	Gem Identification Made Easy. By Antoinette L. Matlins & A.C. Bonanno. This book explains in nontechnical terms how to use pocket, portable, and laboratory instruments to identify diamonds and colored gems. It also shows how to separate real gems from imitations and look-a-likes. Hardcover, 270 pages.	\$37.70
E	62-4500	Gemstone Weight Estimation. By Charles I. Carmona, G.G. This handbook gives you all of the formulas and tables necessary to help you learn to confidently and accurately estimate the weights of all mounted gemstones. This handbook is a must for the workbench, desktop, and/or library of anyone related to the jewelry trade. Softcover, 400 pages.	\$63.75
F	62-4486	Gem Care Book. Fred Ward's revised edition illustrates that gems have different characteristics, hardnesses, toughnesses, and their susceptibility to heat, light, and acids. The author's tips help with keeping your gems safe. Softcover, 33 pages.	\$0.00

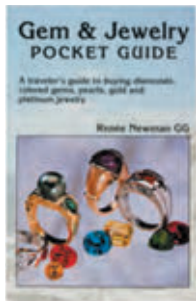

G



H



J

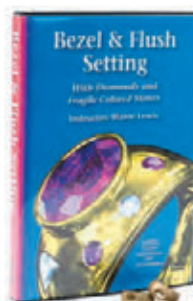

K



L

M

N

P

Q

R

S

Item	Order #	Title/Description	1+	
G	62-4464	Gem & Jewelry Pocket Guide. By Renee Newman, GG. The Gem & Jewelry Pocket Guide provides a concise overview of gems, gold, and platinum. Renee Newman's gem and jewelry books are used throughout the world as consumer guides, salestraining tools, and references for jewelry professionals. 160 pages.	\$14.50	
H	62-4460	The Dealer's Book of Gems & Diamonds. By M. Severdmish and A. Mashian. This is a unique reference work that belongs in every office in the gem and diamond business, and is a treasure house of vital knowledge for the diamond and gem dealer, jeweler, and gemologist. More than 300 color photos and 450 black-and-white illustrations. 1,004 pages, two-volume set.	\$113.55	
J	62-4550	Pursuit of Precious Stones. This exceptional series of 12 documentaries invites you to travel the world in search for the gemstone treasures on the planet earth. The accomplished gemologist, Mr. Patrick Voillet, takes you on an adventure and leads us on the journey to find rare gemstones. Three 52-minute documentaries; 156 minutes.	\$45.80	
K	62-4389	Bezel & Flush Setting. By Blaine Lewis. This two-tape DVD set guides you step by step in bezel and flush setting diamonds and colored stones. Blaine Lewis, master jeweler, uses the latest microscopic DVD and animation techniques to share his expertise with you. It's like being in a live classroom. The DVD set comes with two practice mountings, two sets of practice stones, one GRS® hard steel point, burnisher, and templates. Running time: 150 minutes (total).	\$181.60	
		Turn your DVD player into your private instructor. These DVDs enable you to learn and improve your craft by watching, listening, and allowing you to review each step as needed.	\$25.50	
	L	62-4540 Basic Setting	M	62-4541 Oval Setting
	N	62-4542 Pear Setting	P	62-4543 Marquise Setting
	Q	62-4544 Princess Cut Setting	R	62-4545 Emerald Cut Setting
	S	62-4546 Bezel Setting		

Videos and Books

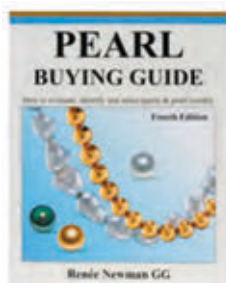

A

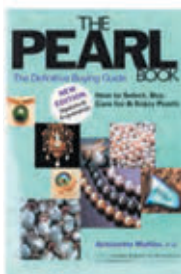

B



C



D



E

Item	Order #	Title/Description	1+
A	62-4466	<i>The Pearl Buying Guide.</i> By René Newman, GG. An indispensable guide with details on judging pearl quality and value. Written in easy-to-read, everyday English by consumer author René Newman, a gemologist with broad experience in pricing, evaluating, and selling gemstones and jewelry. 156 pages.	\$25.70
B	62-4478	<i>The Pearl Book.</i> By Antoinette Matlins. This revised and updated third edition is a comprehensive, authoritative guide that tells readers everything they need to know about pearls to fully understand and appreciate them, and avoid any unexpected—and costly—disappointments, now and in future generations. 232 pages.	\$24.50
C	62-4413	<i>Pearl & Bead Stringing.</i> Excellent step-by-step video by Henrietta Virchick teaches you how to make a beautiful mother of pearl necklace and bracelet. It includes various techniques for creating genuine, precious and semi-precious high-fashion jewelry. Video is very useful for beginners or experienced craftsmen. Running time: 50 minutes.	\$35.20
D	62-4476	<i>Diamond Buying Guide.</i> By Antoinette Matlins. This comprehensive guide, from diamond expert and best-selling author Antoinette Matlins, is the "unofficial bible" for all diamond buyers who want to get the most for their money. 220 pages.	\$19.90
E	62-4455	<i>Straight Talk on Diamonds.</i> By Barry Ellin. Straight Talk on Diamonds is a short course on diamonds, explaining diamond quality in a clear and concise manner. The book and CD set stresses how the different quality factors affect value. The book contains dozens of pictures and diagrams that are easy to follow. This book and CD set is a valuable learning tool and is perfect for salespeople at jewelry stores or anyone new to the field of diamonds.	\$87.75

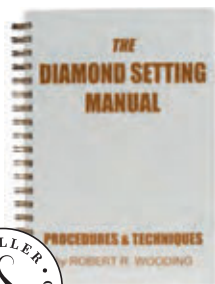

F

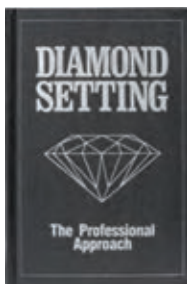

G

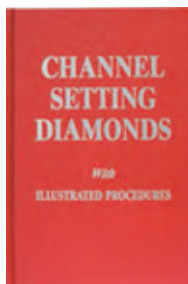

H

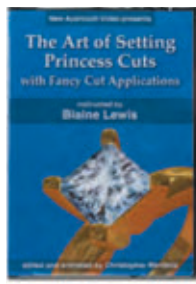

J



K



L

Item	Order #	Title/Description	1+
F	62-4427	<i>Diamond Setting Manual.</i> By Robert R. Wooding. This manual is an incredible source for common diamond setting procedures. It is intended for experienced professional diamond setters, as well as students under the supervision of a qualified, diamond setting instructor. The text is divided into 17 units of instruction and presented in step-by-step sequence. This manual will help diamond setters to progress to high echelons of diamond setting. Softcover, 223 pages, spiral-bound book.	\$40.75
G	62-4421	<i>Diamond Setting.</i> By Robert R. Wooding. The most complete, diamond setting book available. Basic enough to be understood by an apprentice who has little jewelry background. It is also sufficient in depth to benefit an experienced diamond setter. Teaches basic and advanced diamond setting with complete step-by-step details for a variety of procedures. Contains illustrated line drawings of necessary tool preparation, techniques, and procedures. Alternative methods to setting diamonds are also included. Hardcover, 178 pages.	\$30.55
H	62-4423	<i>Channel Setting Diamonds.</i> By Robert R. Wooding. The most advanced, instructional book for channelsetting diamonds. Book is divided into two general sections. The first describes each phase of the channel-setting procedure in-depth. The second describes a variety of complete channel-setting procedures illustrated. Topics covered include: inspection, layout, cutting channels, cutting bearings, inlaid channels, finishing, basic closed channel, basic open channel, curved channels, tapered channels, angular channels, and securing diamonds. Hardcover, 136 pages.	\$32.15
J	62-4395	<i>The Art of Setting Princess Cuts.</i> Hundreds of tips for the stone setter to set princess-cut and fancy-cut stones in standard and V-prong settings. DVD, two hours, 30 minutes.	\$181.60
K	62-4422	<i>Bead-Setting Diamonds with Pavé Applications.</i> By Robert R. Wooding. Step-by-step instruction book on bead setting from a simple operation with one stone to pavé setting many stones. Provides more than 250 close-up photographs of bead-setting tasks supported by detailed line drawings where necessary, to clarify each phase of bead setting. Presented in-depth is tool preparation required to raise beads from plate metal and bright cutting. Hardcover, 192 pages.	\$30.55
L	62-4391	<i>Bead and Bright-Cut Diamond Setting DVD.</i> This video focuses on bead and bright-cut diamond setting. These skills are regarded as a necessary part of advanced bench work. You will learn how to bead-set stones and set multiple small stones in an easy-to follow sequence. From drilling and sizing the stone seats to raising each bead through final bright cuts, and you will see how to exactly do it. Running time: 2 hours.	\$30.55



A



B



C



D



E

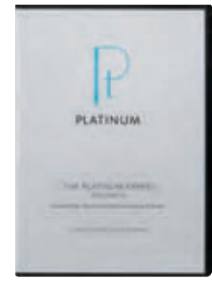

F

Item	Order #	Title/Description	1+
A	62-4447	<i>Moods in Wire</i> . By Ed Sinclair. This book, with several hundred illustrations and 111 pages of explanation, provides a clear introduction to wire wrapping. Learn to make simple and fancy rings, bracelets, earrings, crosses, stick pins, and pendants. Softcover, 112 pages, spiral-bound book.	\$30.55
B	62-4435	<i>The Art of Engraving</i> . By James B. Meek. A magnificent book that includes text, photographs, and drawings ranging from design and layout to selecting proper tools and equipment. This book offers a detailed introduction in layman's terms. The main focus is on gun engraving, but the techniques can be universally applied. Hardcover, 196 pages.	\$47.60
C	62-4453	<i>Jewelry Engravers Manual</i> . This book concentrates on jewelry engraving with special emphasis on lettering, monogramming, and ring engraving. Use of tools and proper work techniques are clearly described. Softcover, 143 pages.	\$9.70
D	62-4397	<i>Successful Jewelry Engraving</i> . Sam Alfano presents this instructional video designed to get you up to speed in the jewelry engraving field quickly. Learn basic to advanced techniques that local stores and manufacturers demand. Learn high-end techniques of relief engraving, sculpting, bright-cut leaf borders, and more. Enjoy 120 minutes of close-up video focusing on ring engraving.	\$54.10
E	62-4393	<i>Engraving Methods and Techniques DVD</i> . This two-DVD set puts years of engraving experience into a four-hour video presentation. Three of the world's most popular engraving methods are shown: hand engraving, chasing hammer engraving, and powerassisted hand engraving.	\$40.75
F	62-4399	<i>The Platinum Expert Vol. IV</i> . The popularity of platinum jewelry has created a demand for accurate information for the bench jeweler. Explore how to work and fabricate platinum jewelry. DVD; 60 minutes.	\$0.00



G

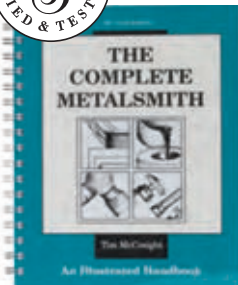

H



J



J

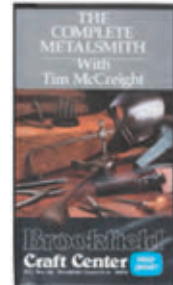

K

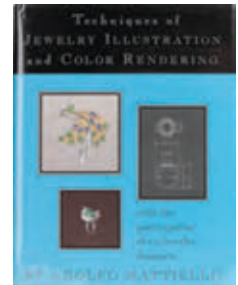

L

Item	Order #	Title/Description	1+
G	62-4433	<i>Silversmithing and Art Metal</i> . By Murray Bovin. Excellent reference guide for all who do metalsmithing. Contains step-by-step text, detailed diagrams, and photographs of metal working, forming techniques, and the decorative process. Softcover, 184-page book.	\$25.50
H	62-4471	<i>The Complete Metalsmith</i> . By Tim McCreight. An illustrated handbook describing everything from metals and their properties to tools and how to use them. Easy-to-follow index makes the answers easy to find. Softcover, 150 pages.	\$21.40
J	62-4488	<i>Student Edition</i> . This Student Edition (160pgs) is perfect for hobbyists, students, and others who are just getting started in metalworking. It covers the basics including a section on metal clay. This Professional Edition (312pgs) covers the same material but goes into greater depth with expanded information for serious artists.	\$15.90
J	62-4488	<i>Professional Edition</i> . This Student Edition (160pgs) is perfect for hobbyists, students, and others who are just getting started in metalworking. It covers the basics including a section on metal clay. This Professional Edition (312pgs) covers the same material but goes into greater depth with expanded information for serious artists.	\$31.80
K	62-4401	<i>The Complete Metalsmith Video</i> . A video encyclopedia that covers basic jewelry-making techniques. Some of the processes included are elements of joining, cutting, forming, and surface techniques. Also included is a section illustrating techniques for making three pieces of jewelry. Running time: 70 minutes.	\$33.50
L	21-0541	<i>Matt Techniques of Jewelry Illustration and Color Rendering Kit</i> . This book provides a splendid array of methods and styles of jewelry illustrations. It includes a method of quick sketching based on the use of templates to guide the beginner as well as the advanced student in the production of precise renderings. Hardcover, 150 pages.	\$44.90

WATCHBAND SELLING SYSTEMS

Selling watchbands couldn't be easier. Our selling systems include spinners, folders, and a space-saving cabinet. Each interchangeable system conveniently displays our best-selling bands and bracelets, giving your customer a multitude of choices. Customize a combination that works for your store.

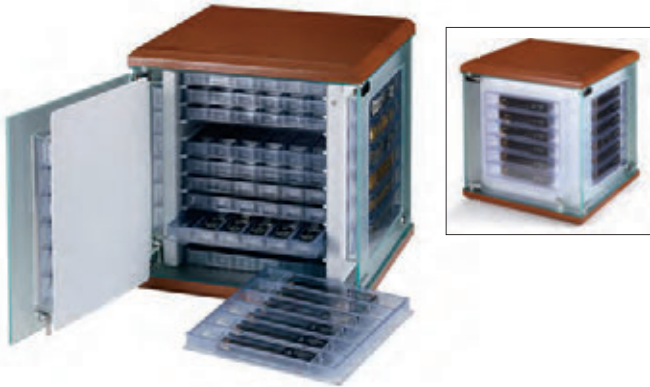

SINGLE SPINNER

Houses 84 straps or bracelets and 14 trays. One tray in each face of the spinner and 10 trays in center storage. Measures 13" x 13" x 12" closed.

61-5403 Leather/Metal Spinner with 48 straps, 30 metal bracelets; 14 trays

61-5408 Metal Spinner with 54 metal bracelets and 14 trays

61-5407 Leather Spinner with 84 leather straps and 14 trays

Order #	Description	1+
61-5403	Single Leather/Metal Watchstrap Spinner	\$649.00
61-5408	Single Metal Watchstrap Spinner	\$599.00
61-5407	Single Leather Watchstrap Spinner	\$549.00



DOUBLE SPINNER

Houses 168 straps or bracelets and 28 trays. Two trays in each face of the spinner and 20 trays in center storage. Measures 13" x 13" x 22"

61-6491 Leather/Metal Spinner with 75 straps, 30 metal bracelets, and 16 center storage trays

61-6493 Metal Spinner with 72 bracelets and 16 storage trays

61-6494 Leather Spinner with 120 watchbands and 16 center storage trays

Order #	Description	1+
61-6491	Double Leather/Metal Watchstrap Spinner	\$899.00
61-6493	Double Metal Watchstrap Spinner (Ladies' and Men's)	\$849.00
61-6494	Double Leather Watchstrap Spinner (Ladies' and Men's)	\$799.00



COUNTERTOP CABINET

Wood countertop cabinet with storage for up to 60 straps or bracelets. Measures 10¾" x 12½" x 22¾".

61-5413 Contains 36 straps and 24 metal bracelets; 10 extra storage trays

61-5412 Contains 60 metal bracelets; 10 extra storage trays

61-5411 Contains 60 leather straps; 10 extra storage trays

Order #	Description	1+
61-5413	Leather and Metal Watchstrap Cabinet	\$529.00
61-5412	Metal Watchstrap Cabinet	\$649.00
61-5411	Leather Watchstrap Cabinet	\$449.00



LIBRARY STYLE WATCH STRAP STORAGE

Our two-gate and four-gate watchband folders make a perfect library-style storage system that conserves precious counter space. See our complete folder collection, including Select straps, at Stuller.com/WatchStraps.

GIFT SET FOLDER FOR STRAPS

Perfect for travel, our black padded leatherette folder has room for three bands and extra compartments for buckles. The lined cover protects the crystal from scratches while changing bands. Measures 5¼" x 10¾" closed.



Order #	Description	1+
LA-505	Gift Set Folder	\$12.95

Watch Tools and Supplies

LEATHER WATCHSTRAP FOUR-GATE FOLDER

Black, padded leatherette folder holds 40 watchbands. Removable universal trays fit into spinners and storage cabinets. Measures 14" x 6½" x 3" closed.



Order #	Description	1+
LA-501	Men's Leather Folder Assortment	\$239.00
LA-503	Ladies' Leather Folder Assortment	\$239.00
LA-500	Folder Only	\$24.95

METAL BRACELET TWO-GATE FOLDER

Black, padded leatherette folder holds 12 metal bracelets or straps. Removable universal trays fit into spinners and storage cabinets. Measures 9¼" x 10¼" x 1¾" closed.



Order #	Description	1+
LA-502	Men's Metal Bracelet Assortment	\$125.00
LA-504	Ladies' Metal Bracelet Assortment	\$125.00
LA-499	Folder Only	\$19.99

Innovative features and quality designs make Stuller watchbands the best on the market. Simplify your business with next-day delivery and no minimum purchase.

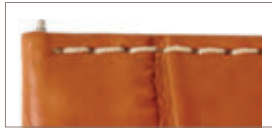

SPRING

All leather straps are packaged with replacement spring bars, eliminating the worries of stocking the proper size spring bars.



EZ – EASY CHANGE

No longer is a specialized tool needed to change your straps. Keep up with current fashions or just match today's wardrobe with the simple sliding of a bar.



MP – MULTI-END PIECE

Our multiple end piece system allows you to order a single metal bracelet to fit multiple sizes—straight or curved. Our metal bands give you complete customization options with reduced inventory costs.



WY – WHITE AND YELLOW BUCKLE

Both gold color options are available and come packaged with each leather strap purchased. Each individual buckle lets you meet a variety of customer needs.



SS – STULLER SELECT

With elegant color match stitching, superior craftsmanship, and distinct padding, this new collection has European style down to the buckle. You can easily identify our new Select line of watchstraps by the silver highlighted packaging.

LEATHER STRAPS

Our selection of 100% premium-grade leather straps are the most durable and highest quality available. Made from an elegant assortment of hides and certified exotic skins, and in a variety of popular styles and eye-catching colors, this collection is always fashionable.



METAL BRACELETS

Using all stainless steel construction, our expansion and link model metal bracelets are the perfect accessories. Our Multi-End design allows you to fit nearly any style watch in any size with ease.



DIVER BANDS

Durability and comfort are what can always be expected from our polyurethane diver and silicone rubber sport bands. What may surprise you, however, is the new assortment of vibrant colors now being made available in this bold style.



WATCH BUCKLES



LADIES' BUCKLE WITH STINGRAY PATTERN

Order #	Metal Quality	Outside Diameter	1+
28171	14kt	8mm	\$150.64
28171	14kt	10mm	\$184.74
28171	18kt	8mm	\$207.80
28171	18kt	10mm	\$253.85
28171	Sterling Silver	8mm	\$45.81
28171	Sterling Silver	10mm	\$47.65



LADIES' DESIGNER WATCH BUCKLE

Order #	Metal Quality	Outside Diameter	1+
28096	14kt	8mm	\$115.03
28096	14kt	10mm	\$228.05
28096	14kt	12mm	\$228.55
28096	14kt	14mm	\$281.27
28096	14kt	16mm	\$340.75
28096	18kt	8mm	\$159.33
28096	18kt	12mm	\$310.10
28096	18kt	14mm	\$391.21
28096	18kt	16mm	\$499.56
28096	Sterling Silver	8mm	\$32.84
28096	Sterling Silver	10mm	\$35.44
28096	Sterling Silver	12mm	\$39.23
28096	Sterling Silver	14mm	\$42.47
28096	Sterling Silver	16mm	\$44.69



MEN'S BUCKLE WITH STINGRAY PATTERN

Order #	Metal Quality	Outside Diameter	1+
28145	14kt	12mm	\$211.54
28145	14kt	14mm	\$269.79
28145	14kt	16mm	\$344.42
28145	18kt	12mm	\$281.26
28145	18kt	14mm	\$388.20
28145	18kt	16mm	\$500.00
28145	Sterling Silver	12mm	\$49.11
28145	Sterling Silver	14mm	\$53.19
28145	Sterling Silver	16mm	\$57.45



MEN'S BUCKLE WITH BEZEL ACCENT

Order #	Metal Quality	Outside Diameter	1+
28134	14kt	8mm	\$145.18
28134	14kt	10mm	\$181.13
28134	14kt	12mm	\$237.77
28134	14kt	14mm	\$284.41
28134	14kt	16mm	\$374.26
28134	18kt	8mm	\$199.61
28134	18kt	10mm	\$248.80
28134	18kt	12mm	\$325.49
28134	18kt	14mm	\$410.22
28134	18kt	16mm	\$544.76
28134	Sterling Silver	8mm	\$45.52
28134	Sterling Silver	10mm	\$47.46
28134	Sterling Silver	12mm	\$50.74
28134	Sterling Silver	14mm	\$54.04
28134	Sterling Silver	16mm	\$59.16

EZ CHANGE SPRING BAR KITS AND REFILLS

This 84-piece Spring Bar Kit includes 12 pieces of each per vial: 10mm, 12mm, 14mm, 16mm, 18mm, 20mm, and 22mm. Refills may be ordered by size.

Order #	Description	12+	6+	1+
59-2050	84-Piece Kit	\$32.00	\$34.70	\$38.55
59-2051	Refills (order by size 12 piece per vial)	\$6.76	\$7.61	\$8.45



Enlarged to Show Detail
Tool Length: 3/8"-7/8"





12

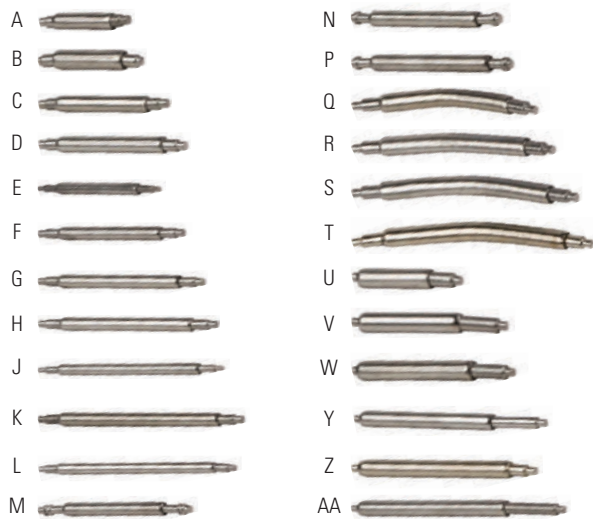

STAINLESS STEEL DOUBLE SHOULDER SPRING BARS

Kit consists of 288 pieces total. Color of holding case may vary.

Item	Order #	Description	12+	6+	1+
	59-2020	Spring Bar Assortment Kit (288-Pieces)	\$15.64	\$16.32	\$17.00
A	59-1300	1/4" Shoulder Thin BTL #1	\$0.64	\$0.68	\$0.75
B	59-1301	5/16" Shoulder Thin BTL #2	\$0.64	\$0.68	\$0.75
C	59-1302	3/8" Shoulder Thin BTL #3	\$0.64	\$0.68	\$0.75
D	59-1303	7/16" Shoulder Thin BTL #4	\$0.64	\$0.68	\$0.75
E	59-1304	1/2" Shoulder Thin BTL #5	\$0.64	\$0.68	\$0.75
F	59-1305	5/16" Shoulder Thin BTL #6	\$0.64	\$0.68	\$0.75
G	59-1306	5/8" Shoulder Thin BTL #7	\$0.64	\$0.68	\$0.75
H	59-1307	1 1/16" Shoulder Thin BTL #8	\$0.64	\$0.68	\$0.75
J	59-1308	3/4" Shoulder Thin BTL #9	\$0.64	\$0.68	\$0.75
K	59-1309	1 3/16" Shoulder Thin BTL #10	\$0.64	\$0.68	\$0.75
L	59-1310	1 5/16" Shoulder Thin BTL #11	\$0.64	\$0.68	\$0.75
M	59-1311	5/8" Stainless Double Flange Short Tip BTL #12	\$0.64	\$0.68	\$0.75
N	59-1312	1/2" Stainless Double Flange Short Tip BTL #13	\$0.64	\$0.68	\$0.75
P	59-1313	1 1/16" Stainless Double Flange Short Tip BTL #14	\$0.64	\$0.68	\$0.75
Q	59-1314	3/16" Double Shoulder Curved BTL #15	\$0.64	\$0.68	\$0.75
R	59-1315	5/8" Double Shoulder Curved BTL #16	\$0.64	\$0.68	\$0.75
S	59-1316	1 1/16" Double Shoulder Curved BTL #17	\$0.64	\$0.68	\$0.75
T	59-1317	3/4" Double Shoulder Curved BTL #18	\$0.64	\$0.68	\$0.75
U	59-1318	1/4" - 5/16" Telescopic BTL #19	\$0.64	\$0.68	\$0.75
V	59-1319	3/8" - 7/16" Telescopic BTL #20	\$0.64	\$0.68	\$0.75
W	59-1320	1/2" - 5/16" Telescopic BTL #21	\$0.64	\$0.68	\$0.75
Y	59-1321	5/8" - 1 1/16" Telescopic BTL #22	\$0.64	\$0.68	\$0.75
Z	59-1322	1 1/16" - 3/4" Telescopic BTL #23	\$0.64	\$0.68	\$0.75
AA	59-1323	1 3/16" - 7/8" Telescopic BTL #24	\$0.64	\$0.68	\$0.75



20

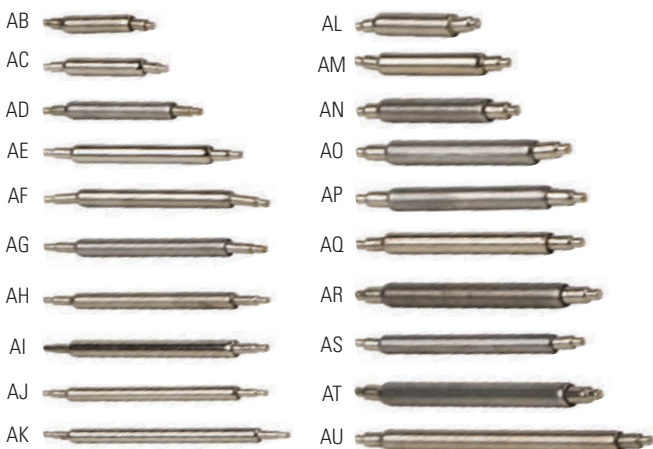

SEMI-STAINLESS STEEL DOUBLE SHOULDER SPRING BARS

Kit consists of 400 semi-stainless pieces of the most commonly used spring bars. 200 pieces are extra thin and 200 pieces are regular. Made of semi-stainless steel.

Item	Order #	Description	12+	6+	1+
	59-2030	Spring Bar Assortment Kit (400-Pieces)	\$13.66	\$14.26	\$14.85
AB	59-1344	1/4" Extra-Thin BTL #1	\$0.68	\$0.72	\$0.80
AC	59-1345	5/16" Extra-Thin BTL #2	\$0.68	\$0.72	\$0.80
AD	59-1346	3/8" Extra-Thin BTL #3	\$0.68	\$0.72	\$0.80
AE	59-1347	7/16" Extra-Thin BTL #4	\$0.68	\$0.72	\$0.80
AF	59-1348	1/2" Extra-Thin BTL #5	\$0.68	\$0.72	\$0.80
AG	59-1349	5/8" Extra-Thin BTL #6	\$0.68	\$0.72	\$0.80
AH	59-1350	5/8" Extra-Thin BTL #7	\$0.68	\$0.72	\$0.80
AI	59-1351	1 1/16" Extra-Thin BTL #8	\$0.68	\$0.72	\$0.80
AJ	59-1352	3/4" Extra-Thin BTL #9	\$0.68	\$0.72	\$0.80
AK	59-1353	1 3/16" Extra-Thin BTL #10	\$0.68	\$0.72	\$0.80
AL	59-1354	5/16" Regular BTL #11	\$0.68	\$0.72	\$0.80
AM	59-1355	3/8" Regular BTL #12	\$0.68	\$0.72	\$0.80
AN	59-1356	7/16" Regular BTL #13	\$0.68	\$0.72	\$0.80
AO	59-1357	1/2" Regular BTL #14	\$0.68	\$0.72	\$0.80
AP	59-1358	5/8" Regular BTL #15	\$0.68	\$0.72	\$0.80
AQ	59-1359	5/8" Regular BTL #16	\$0.68	\$0.72	\$0.80
AR	59-1360	1 1/16" Regular BTL #17	\$0.68	\$0.72	\$0.80
AS	59-1361	3/4" Regular BTL #18	\$0.68	\$0.72	\$0.80
AT	59-1362	1 3/16" Regular BTL #19	\$0.68	\$0.72	\$0.80
AU	59-1363	1 5/16" Regular BTL #20	\$0.68	\$0.72	\$0.80

DOUBLE SHOULDER SPRING BAR KIT

Includes: 700 regular pieces total.

- 100 5/16" (.90mm)
- 100 3/8" (1.10mm)
- 100 7/16" (1.20mm)
- 100 1/2" (1.50mm)
- 100 5/8" (1.80mm)
- 100 11/16" (1.90mm)
- 100 3/4" (2.10mm)



Order #	Description	1+
59-1500	Spring Bar Kit (700-Pieces)	\$15.55

EXTRA-THIN SEMI-STAINLESS SPRING BAR KIT

Includes: 200 semi-stainless pieces total.

- 20 (1/4") - #1
- 20 (5/16") - #2
- 20 (3/8") - #3
- 20 (7/16") - #4
- 20 (1/2") - #5
- 20 (9/16") - #6
- 20 (5/8") - #7
- 20 (11/16") - #8
- 20 (3/4") - #9
- 20 (13/16") - #10



Order #	Description	12+	6+	1+
59-2010	Spring Bar Kit (200-Pieces)	\$11.86	\$12.56	\$13.95

EXTRA-THIN SPRING BAR ASSORTMENT KIT

Includes: 200 semi-stainless pieces total.

- 20 (1/4") - #1
- 20 (5/16") - #2
- 20 (3/8") - #3
- 20 (7/16") - #4
- 20 (1/2") - #5
- 20 (9/16") - #6
- 20 (5/8") - #7
- 20 (11/16") - #8
- 20 (3/4") - #9
- 20 (13/16") - #10



Order #	Description	12+	6+	1+
59-2000	Spring Bar Kit (200-Pieces)	\$14.41	\$15.26	\$16.95

COTTER PIN ASSORTMENT

Five pieces each in 33 different lengths: 4.5mm to 20.50mm in 0.5mm increments. All in 0.9mm diameter, being the most commonly used.

Order #	Description	Length (mm)	12+	6+	1+
58-2503	Cotter Pin Assortment		\$25.08	\$26.55	\$29.50
58-2505	Refills (by size, 10 pieces per vial)	4.5–22.0	\$2.51	\$2.66	\$2.95





STAINLESS STEEL STRAIGHT BRACELET PIN ASSORTMENT

60-piece assortment offering six each of 10 diameters (0.8mm through 1.8mm in 0.1mm increments). 30mm length.



Order #	Description	12+	6+	1+
58-2502	Bracelet Pin Assortment	\$8.50	\$9.00	\$10.00



STAINLESS STEEL STAMPED END BRACELET PINS ASSORTMENT

One end is stamped for a tight friction fit. 27mm length with five different diameters (0.8mm, 0.9mm, 1.0mm, 1.1mm, and 1.2mm). Each pin size comes with a heavy and light stamp.

Order #	Description	12+	6+	1+
58-2501	60-Piece Pin Assortment	\$8.50	\$9.00	\$10.00

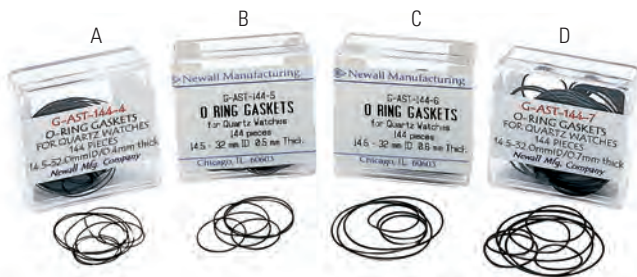

GASKET ASSORTMENT

A wide selection of popular sizes, meticulously separated by thickness. Four pieces each of 36 different diameters (14.5 to 32.0mm). Fits Seiko®, Citizen®, and most modern quartz watches.



Item	Order #	Thickness	12+	6+	1+
A	59-1050	.04 mm	\$7.04	\$7.68	\$8.00
B	59-1052	.05 mm	\$7.04	\$7.68	\$8.00
C	59-1054	.06 mm	\$7.04	\$7.68	\$8.00
D	59-1056	.07 mm	\$7.04	\$7.68	\$8.00



66-PIECE THIN O-RING ASSORTMENT

Three each of 22 popular numbers.

Order #	Description	12+	6+	1+
59-1062	Thin O-Ring Gasket Assortment	\$20.70	\$21.60	\$22.50



OPTICAL SCREWS

Assorted yellow and white screws for eyeglasses.



Order #	Description	12+	6+	1+
58-2500	Optical Screw Assortment	\$13.56	\$14.36	\$15.95

90-PIECE O-RING GASKET ASSORTMENT

Three each of 30 popular numbers.

Order #	Description	12+	6+	1+
59-1061	O-Ring Gasket Assortment	\$20.47	\$21.36	\$22.25



90-PIECE FLAT GASKET ASSORTMENT

Three each of 30 popular numbers.

Order #	Description	12+	6+	1+
59-1060	Flat Gasket Assortment	\$45.91	\$47.90	\$49.90



105-PIECE ROLEX® CASEBACK GASKET ASSORTMENT

Three each of 35 sizes, flat and round.

Order #	Description	12+	6+	1+
59-1065	Caseback Gasket Assortment	\$59.80	\$62.40	\$65.00



54-PIECE FLAT-CASEBACK GASKET ASSORTMENT

Three each of 18 popular numbers.

Order #	Description	12+	6+	1+
59-1064	Flat Gasket Assortment	\$22.95	\$23.95	\$24.95



UV LIGHT BOX

This UV light box is designed to speed up the curing time for all UV glues.

Order #	Description	12+	6+	1+
12-2054	UV Light Box	\$36.13	\$38.25	\$42.50



7½" L x 3½" H



"UV" CLEAR GLASS ADHESIVE

Creates a crystal clear bond. Expose to UV light to cure in seconds. Use for bonding glass to metal. Can also be used for bonding light colored stained glass, but it is not recommended for deep colored stained glass. 3cc syringe.

Order #	Description	12+	6+	1+
12-2053	Clear Glass Adhesive	\$6.53	\$6.82	\$7.10



SUC ROCKET CRYSTAL CEMENT

Highly adhesive, quality cement ensures greater holding power. Can be used on any unbreakable crystal or foil-back jobs. Needlepoint tube ensures proper use and does not permit the cement to solidify in the nozzle.

Order #	Description	12+	6+	1+
12-2100	Crystal Cement (20 second curing time)	\$6.12	\$6.38	\$6.65



COMPOUND 7 SILICONE WATCH SEALANT

Silicone compound withstands high pressures and vacuums. No leaking in water or air even under the most drastic conditions. Unaffected by temperatures - 280°F to 485°F. Will not evaporate, vaporize, harden, break down, and will not effect watch oils.

Order #	Description	12+	6+	1+
58-2557	Silicone Watch Case Sealant	\$6.50	\$6.89	\$7.65



"RE-NEW-ALL" PLASTIC RENEWER

Makes any plastic watch crystal look brand new. Wheel is charged with compound, and plastic crystal is gently buffed.

Order #	Description	Size	12+	6+	1+
47-3100	Crystal Polisher	6 oz bar	\$5.20	\$5.42	\$5.65



SILICONE SEALANT BOX

Keep watch gaskets lubricated and flexible with the silicone sealant box. Sponges are impregnated with silicone grease. Simply insert your gaskets, close the lid, and twist for a gasket with a tighter, longer seal.

Order #	Description	12+	6+	1+
64-5112	Silicone Sealant Box	\$4.97	\$5.18	\$5.40



RODICO® CLEANING COMPOUND

Special watchmaker's product for removing fingerprints, stains, and excess oil. Soft and pliable, it comes with two sticks per box.

Order #	Description	Size	12+	6+	1+
58-2805	Rodico Cleaning Compound	16 oz	\$14.75	\$15.62	\$17.35

MICRO-LUBE 2, SYRINGE

Stem and winding gear lubricant in a 5cc syringe with one tip.

Order #	Description	Size	12+	6+	1+
58-2556	Gear Lubricant in Syringe	5 cc	\$6.58	\$6.86	\$7.15



MICRO-LUBE 2, JAR

Stem and winding gear lubricant extra-fine grease exceptional for stem and winding gears. Will not run or spread. Perfect for chronographs.

Order #	Description	Size	12+	6+	1+
58-2558	Gear Lubricant	1 oz jar	\$4.00	\$4.18	\$4.35



POLYWATCH® SCRATCH REMOVER

Removes scratches from plastic watch crystals. Simply polish scratch area with a piece of wool for 2 to 3 minutes and renew the luster of that worn-out crystal.

Order #	Description	Size	12+	6+	1+
64-5100	Scratch Remover	5 grams	\$5.48	\$5.81	\$6.45



DIP OILER SET

Non-rolling handles are color-coded for quick identification. Oilers are 3/4" overall; shaft, 2 1/4". Comes with 1 each of green, red, blue and black dips.

Order #	Description	12+	6+	1+
58-2555	Dip Oiler Set (4 piece set)	\$8.93	\$9.45	\$10.50



QUICKEN® LUBE

NanoLube contains NanoDiamonds, which act as ball bearings and eliminate friction and wear. NanoDiamonds are 0.1-4 nanometer synthetic diamond ball bearings that never wear out. On average, it takes 80,000 NanoLube particles to span the width of a human hair—and all particles are spherical, synthetic diamond.

Item	Order #	Description	Size	1+
A	58-2540	NanoLube for Clock	2 ml jar	\$27.00
B	58-2541	NanoLube for Watch	2 ml jar	\$27.00
C	58-2542	NanoLube for Multi-Purpose Watch	2 ml jar	\$27.00



MOEBIUS WATCH AND CLOCK OIL

Efficient and reliable high-quality lubricants for wrist watches, pocket watches, and small and large clocks. Very good adherence, non-toxic, and good viscosity. Range of application: -36°C to +80°C.

Item	Order #	Description	Size	1+
D	58-2550	Quartz Watch Oil	20 ml jar	\$38.55
E	58-2551	Wrist Watch Oil	20 ml jar	\$40.00
F	58-2552	Pocket Watch Oil	20 ml jar	\$20.15
G	58-2553	Clock Oil	20 ml jar	\$20.45

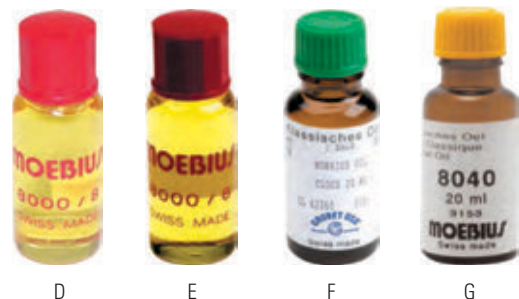

Detachable

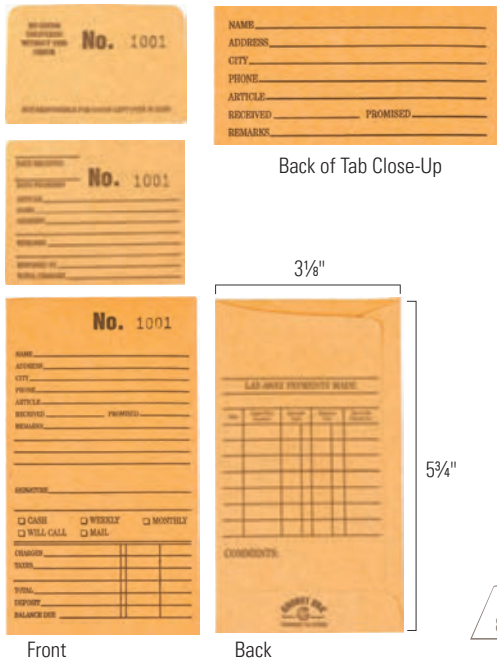

TRIPLE-DUTY REPAIR ENVELOPES

Each numbered envelope has two detachable stubs with corresponding numbers; one for the customer and one for filing. Printed on standard kraft paper. Measures 3 1/8" x 5 3/4". Sold in packs of 1,000.



Order #	Description	Envelope #	12+	6+	1+
61-1510	Repair Envelope	1-1000	\$36.98	\$38.25	\$42.50
61-1520	Repair Envelope	1001-2000	\$36.98	\$38.25	\$42.50
61-1530	Repair Envelope	2001-3000	\$36.98	\$38.25	\$42.50
61-1540	Repair Envelope	3001-4000	\$36.98	\$38.25	\$42.50
61-1550	Repair Envelope	4001-5000	\$36.98	\$38.25	\$42.50
61-1555	Repair Envelope	5001-6000	\$36.98	\$38.25	\$42.50
61-1556	Repair Envelope	6001-7000	\$36.98	\$38.25	\$42.50
61-1557	Repair Envelope	7001-8000	\$36.98	\$38.25	\$42.50
61-1558	Repair Envelope	8001-9000	\$36.98	\$38.25	\$42.50
61-1559	Repair Envelope	9001-9999	\$36.98	\$38.25	\$42.50

Watch Tools and Supplies



5 3/4" W x 10 1/4" L x 1 1/4" Thickness

ORGANIZATION TRAYS AND VIALS

Paper-covered trays with magnetic closure and clear view lid.

Vials have swing-top lids.

Small Bottle: 6mm hole (1/2" W x 1 1/2" H)

Large Bottle: 10mm hole (1/2" H)

Item	Order #	Description	12+	6+	1+
A	59-2115	Black Tray (24 lime green vials)	\$22.49	\$22.98	\$24.45
B	59-2105	Black Tray (36 black vials)	\$17.31	\$17.91	\$19.90
C	59-2110	Large Plastic Vial with Lime Green Lid	\$0.83	\$0.86	\$0.95
D	59-2100	Small Plastic Vial with Black Lid	\$0.52	\$0.54	\$0.60



6" W x 9 1/2" L x 1" Thickness



1/2" H



1/2" W x 1 1/2" H



MOVEMENT TRAYS

Stackable round five compartment trays.



Order #	Description	W x H	12+	6+	1+
15-2074	Movement Trays (set of 6)	3 1/4" x 3 1/4"	\$11.18	\$11.66	\$12.15

ROUND TIN CANS

Made of tin and perfect for storing watch parts, stones, or findings.



Order #	Description	W x H	12+	6+	1+
15-2075	Tin Cans (pack of 12)	2" x 3/4"	\$12.33	\$13.37	\$14.85

WATCH REPAIR TRAY WITH COVER

Six-compartment tray with clear cover. Stackable trays.



Order #	Description	W x L x H	12+	6+	1+
15-2073	Repair Tray with Cover	9 1/2" x 4 3/8" x 3/4"	\$15.26	\$16.16	\$17.95

CLEAR GLASS WITH KNOB

Edges of cover and cup are ground to form a tight seal, keeping dust from entering.



Order #	Description	W x H	12+	6+	1+
58-2705	Movement Cover and Tray	4" x 2 1/4"	\$17.98	\$19.04	\$21.15

NO-LINT, ANTI-TARNISH TISSUES

Best quality. Made in the USA.



Order #	Description	W x L	12+	6+	1+
23-5550	Anti-Tarnish Tissue (box of 1,000)	4" x 4"	\$5.52	\$5.72	\$6.35

GLASS ALCOHOL CUP

Plain alcohol cup for benzene or other solutions. Edges of covers and cups are ground to form a tight seal, keeping dust from entering and protecting solutions from evaporation.



4" diameter x 2 3/4" H

Order #	Description	Size	12+	6+	1+
64-5116	Alcohol Cup	8 oz jar	\$21.04	\$22.28	\$24.75



WATCHMAKER'S BENCH

Our Stuller custom Watchmaker's bench is made in the USA with a solid Gibraltar top that is routed along the edge to prevent parts from rolling away. This red oak fully skirted bench features a 15" steel lined catch drawer with a removable leather insert. Eight graduated drawers include one lockable and dividable small parts drawer, with six bank drawers, one 6" D x 2 7/8" H tool holder, and also includes one center roll out work surface. Large satin nickel pulls give it a modern look while improving function. This bench comes equipped with a quality version of the classic watchmakers vise suitable for precision work. Only the base secures into the bench surface. This vise can be quickly removed from its mounting base by sliding a lever back that reattaches quickly by sliding the lever forward. The European arm rests are tilted, adjustable, upholstered, and padded in brown imitation leather to keep you really comfortable. Special ergonomic shape prevents fatigue at the bench and makes it really easy to work. Inlaid bushing for Dazor® lamps on either side of the bench. Ships completely assembled by truck freight.

Order #	Description	W x D x H	1+
13-0441	Watchmaker's Bench	60" x 24" x 44"	\$3,800.00



Removable vise

Liner

Steel-lined drawer

Adjustable arm rests

Dazor light bushing



DELUXE BATTERY TOOL KIT (EVEREADY® TOOL KIT)

Contains the tools you need to change a battery in a convenient, faux-leather pouch. Has a zipper and elastic bands to keep tools securely in place. Shipped with a complete list of tools for easy replacement.

Order #	Description	1+
59-2500	Battery Tool Kit	\$31.15



Find added video content on Stuller.com.

WATCH TOOL KIT

This watch kit is specifically designed for watch battery replacement of all brand name watches. The tools included will allow you to open the watch back, remove the old watch battery, safely handle all components, replace your watch batteries, size or replace your watch band, replace or adjust watch band clasp, or remove watch band links.

- Pocket case opener
- Yellow case opener
- Aluminum spring bar tool
- Watchmakers hammer
- Blue band opener
- Bracelet holding block
- 1.6mm screwdriver
- Case holder
- 2.0mm screwdriver
- Multi-function watch band remover
- Plastic tweezers

Order #	Description	1+
59-2600	Watch Tool Kit	\$40.80

CLOCK AND INSTRUMENT CLEANING BRUSHES

Bristles are available in varying degrees of hardness for cleaning and dusting clocks, instruments, and parts. Bristles measure 4½" (114mm) long and 5⁄8" (16mm) deep. Overall length 10¼" (260mm).

Half-Hard Cleaning Brushes: For general cleaning

Half-Soft Cleaning Brushes: For more delicate parts

Soft Cleaning Brushes: For removing dust



Item	Order #	Description	12+	6+	1+
A	58-2700	Half-Hard Cleaning Brushes	\$6.29	\$6.66	\$7.40
B	58-2701	Half-Soft Cleaning Brushes	\$6.50	\$6.89	\$7.65
C	58-2702	Soft Cleaning Brushes	\$7.10	\$7.52	\$8.35

"THE ORIGINAL" FLORIDA PITHWOOD

Box of selected button pith, ideal for holding small parts for inspection and cleaning oil from parts. Assorted pieces.



Order #	Description	12+	6+	1+
58-2704	Florida Pithwood	\$5.61	\$5.94	\$6.60

IMPORTED PEGWOOD

Selected orangewood for cleaning pivot holes and various other uses. Approximately 18-24 sticks per bundle.



Order #	Diameter	Length	12+	6+	1+
58-2703	2mm	5¾"	\$7.44	\$7.88	\$8.75

SNAP-BACK CASE OPENER

Snap-Back case opener opens watch cases quickly and easily. The blade is reversible for multiple uses.



Item	Order #	Description	1+
D	59-0482	Snap-Back Case Opener	\$101.40
E	59-0483	Replacement Blades (sold in pairs)	\$33.00

CASE OPENERS

These case openers accept medium and large watches that are found in today's market. It will securely hold watch cases without marring or scratching the watch case.

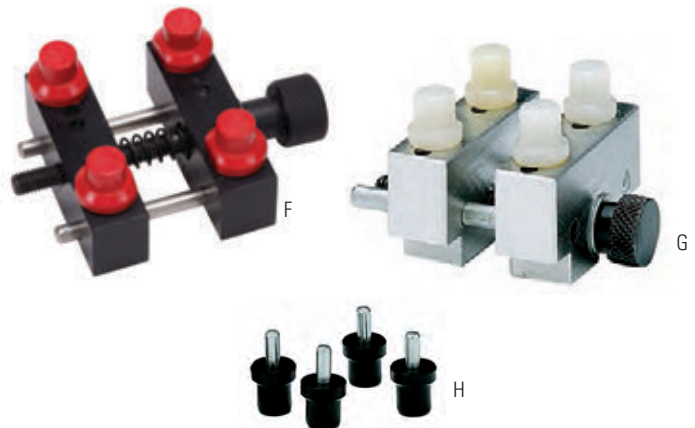

Item	Order #	Description	12+	6+	1+
F	64-4080	Large Case Opener	\$14.03	\$14.85	\$16.50
G	64-4077	Medium Case Opener	\$6.46	\$6.84	\$7.60
H	64-4078	Replacement Pins (4)	\$5.61	\$5.94	\$6.60



BERGEON ROLEX® CASE OPENER SET

For opening Rolex® Oyster® waterproof watches. Unit comes with six milled rings (18.5, 20.2, 22.5, 26.5, 28.3, and 29.5mm). Made in Switzerland.

Order #	Description	1+
59-0645	Watch Case Opener	\$185.00



CASE OPENER

Six-piece ring set with key for opening and closing waterproof watch cases. Includes 18.5mm, 20.2mm, 22.5mm, 26.5mm, 28.5mm, and 29.5mm.

Order #	Description	1+
59-0646	Watch Case Opener	\$69.50



POCKET-SIZED CASE OPENER

Wrench used for opening waterproof cases. Compact and convenient. Tempered pins and adjusting wheel.

Order #	Description	W x H x D	12+	6+	1+
59-0487	Case Opener	2 5/8" x 1/2" x 1 1/8"	\$3.91	\$4.14	\$4.60



WATCH CASE OPENER SET

Watch case opener in wooden box, complete with set of pins. (max opening dimensions - 36.5 mm)

Order #	Description	1+
59-0562	Watch Case Opener with Pins	\$11.00



WATERPROOF CASE OPENER

Case wrench modeled after the famous Jaxa. This version offers exceptional value while still meeting quality standards. Comes complete with set of pins. (max opening dimensions - 36 mm)

Item	Order #	Description	Length	1+
A	59-0560	Watch Case Opener with Pins	5 1/2"	\$9.45
	59-0561	12-Piece Replacement Pins		\$1.75



WATCH CASE OPENER

High quality waterproof watch case wrench is a new, larger style of watch case back openers. (max opening dimensions - 54.5 mm)

Order #	Description	1+
59-0565	Watch Case Opener with Pins	\$27.50

WATER PROOF TESTER

This tester serves multiple purposes. Its main use is for testing the water resistance of a watchcase. It provides a one to ten bar waterproof test in atmospheric pressure. In addition, it will also help you locate any leaks on a watchcase.



Order #	Description	1+
59-3005	Pressure Tester	\$575.00

LG OPENALL WATERPROOF CASE WATCH SET

Specially designed to open Rolex® Oyster® Cases. The six tempered rings accurately interlock with the edges on genuine Rolex® cases. Sturdy cast frame fits any bench vise. Built-in, adjustable case holder fits all size watches. Ring sizes are 18.5, 20.5, 22.5, 26.5, 28.3, 29.5 millimeters. Made in the USA.

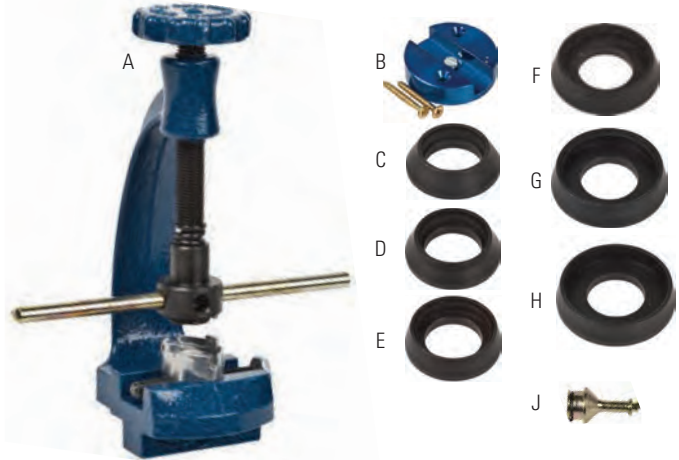

Item	Order #	Description	Gauge Size	12+	6+	1+
A	59-0650	Case Wrench Set	18.5-29.5 mm	\$65.03	\$68.85	\$76.50

REPLACEMENTS

B	59-0651	LG Openall Base		\$13.60	\$14.40	\$16.00
C	59-0652	Replacement Rings	18.5 mm	\$8.37	\$8.87	\$9.85
D	59-0659	Replacement Rings	20.2 mm	\$8.37	\$8.87	\$9.85
E	59-0653	Replacement Rings	22.5 mm	\$8.37	\$8.87	\$9.85
F	59-0654	Replacement Rings	26.5 mm	\$8.37	\$8.87	\$9.85
G	59-0655	Replacement Rings	28.3 mm	\$8.37	\$8.87	\$9.85
H	59-0656	Replacement Rings	29.5 mm	\$8.37	\$8.87	\$9.85
J	59-0657	Center Pin		\$3.83	\$4.05	\$4.50

WATCH CASE-CLOSING PLIERS

Provides safe and dependable closing of watch cases. Jaws close parallel with circular, rubber-padded, hinged discs.

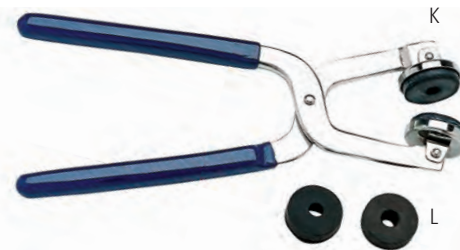

Item	Order #	Description	Length	12+	6+	1+
K	46-8050	Closing Pliers	7½"	\$11.22	\$11.88	\$13.20
L	46-8055	Set of Replacement Pads		\$1.70	\$1.80	\$2.00

STAINLESS STEEL CASE OPENER

This new opener is made for screw-back watch cases. The 4½" handle provides enough leverage to open those stubborn watch case backs. (max opening dimensions - 57 mm)



Order #	Description	12+	6+	1+
59-0564	Case Opener	\$18.91	\$20.02	\$22.25

STAINLESS STEEL CASE OPENER V-STYLE

This universal watch case opener will remove various types of screw-on case backs. (max opening dimensions - 35.5 mm)



Order #	Description	12+	6+	1+
59-0563	V-Style Case Opener	\$28.26	\$29.93	\$33.25



CASE OPENER

Suction-type case opener. Great for lifting the case back off of screwback and waterproof watches after back has been loosened. Rubber end does not scratch cases or crystals. Made in Switzerland.

Order #	Description	12+	6+	1+
59-0472	Case Opener	\$3.83	\$4.05	\$4.50



WATCH CASE OPENER

Easy-to-use watch case opener for snap-type case backs.

Order #	Description	12+	6+	1+
59-0411	Watch Case Opener	\$4.89	\$5.18	\$5.75



SNAPPY CASE OPENER

Designed to make opening watch cases easier. Just position the point between the case back and the case, then slowly push. The blade pops under the back and the watch case easily opens.

Order #	Description	12+	6+	1+
59-0473	Snappy Case Opener	\$9.27	\$9.81	\$10.90

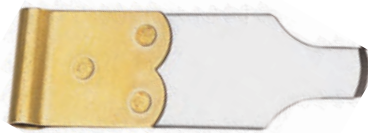

POCKET-SIZED CASE OPENER

Handy, pocket-sized case opener.

Order #	Description	W x L	12+	6+	1+
59-0410	Case Opener	2 3/8" x 5/8"	\$3.87	\$4.10	\$4.55



CRYSTAL LIFT AND PLATE

Removes and inserts 10 to 45 mm unbreakable crystals without dismantling the watch. Simple turning action opens and closes the brass jaws. Made in Switzerland.

Order #	Description	12+	6+	1+
64-5104	Bergeon Crystal Lift/Plate	\$73.31	\$77.63	\$86.25
64-5105	Economy Lift/Plate	\$18.49	\$19.58	\$21.75



BERGEON CASE CUSHION

Held together firmly with a sturdy metal ring, this vinyl pad will hold crystals comfortably without scratching. Ideal for supporting watches while opening or closing cases.

Order #	Description	Diameter	12+	6+	1+
64-5102	Case Cushion	2"	\$49.30	\$52.20	\$58.00

CASE KNIFE

Sturdy German-made case knife with a comfortable red, cushion grip PVC handle. The blade has a single bevel edge for removing case backs. Knife is made from well-tempered tool steel.

Order #	Description	Length	12+	6+	1+
59-0476	Case Knife	4½"	\$15.34	\$16.25	\$18.05



BLADE-STYLE WATCHCASE OPENER

Used for opening friction-fit cases. Universally popular shape gives the watchmaker the small handle necessary to obtain the proper grip when trying to open watch case backs. Blade is made of tempered steel set in a hardwood, non-roll handle.

Order #	Description	Length	12+	6+	1+
59-0470	Watch Case Opener	4½"	\$4.55	\$4.82	\$5.35



WATCH CASE KNIFE

Easy-to-use watch case opener for snap-type case backs.

Order #	Description	Length	12+	6+	1+
59-0475	Watch Case Opener	3½"	\$3.74	\$3.96	\$4.40



FIBERBOARD BENCH PLATE

This enameled fiberboard will not warp and features grooved edges to prevent parts from rolling off.

Order #	Description	W x L x H	12+	6+	1+
13-3805	Fiberboard Bench Plate	9" x 16" x ¼"	\$8.93	\$9.45	\$10.50



SCREW-HOLDING TWEEZERS

Ideal for battery clamps and screws, the v-shaped notch makes it possible to hold the smallest screws for assembly.

Order #	Description	Length	12+	6+	1+
57-7525	Screw-Holding Tweezers	4¾"	\$9.35	\$9.90	\$11.00



ANTI-STATIC BENCH MAT

Flexible mat used for organizing tools and projects.

Order #	Description	W x L	12+	6+	1+
59-0488	Light Green Mat	14" x 9½"	\$11.50	\$12.00	\$12.50



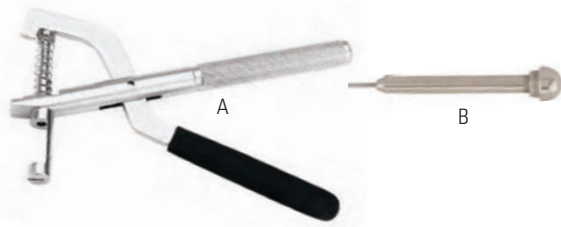

BRACELET PIN REMOVING PLIERS

Quickly remove pins from watchband with these easy-to-use pliers. Non-slip handles provide excellent leverage to handle even the most stubborn pins.

Item	Order #	Description	Pin Size	12+	6+	1+
A	64-5003	Economy Pin Pliers		\$19.64	\$20.79	\$23.10
B	64-5004	Replacement Pin	.80 mm	\$2.13	\$2.25	\$2.50
	64-5004	Replacement Pin	1.0 mm	\$2.13	\$2.25	\$2.50



WATCHBAND LINK REMOVER

Easily adjust watchbands using this tool. Perfect for removing clip springs in link watchbands.

Order #	Description	Length	12+	6+	1+
64-5000	Link Remover	5"	\$9.35	\$9.90	\$11.00

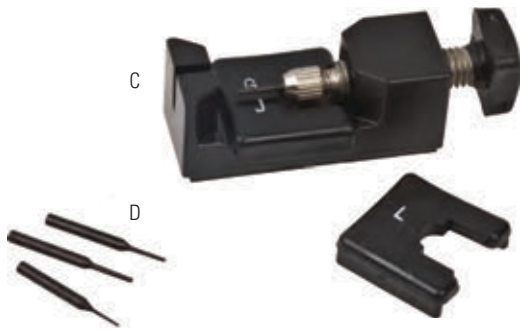

LINK PIN REMOVER

Used to remove pins from metal link bands. Made of Keltec II glass-filled nylon. Includes two extra spacers to accommodate all bracelet sizes. Pusher pin is made of hardened tool steel. Will not scratch or mar gold or silver. Four pins included; two 1.0mm, one .65mm, and one .85mm.

Item	Order #	Description	12+	6+	1+
C	59-0800	Link Pin Remover	\$11.01	\$11.66	\$12.95
D	59-0813	Replacement Pins	\$3.19	\$3.38	\$3.75

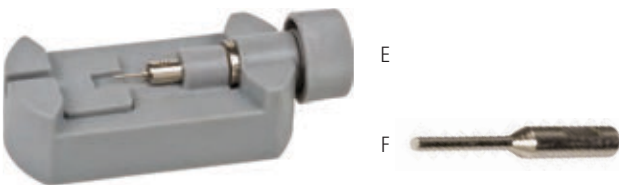

DELUXE BRACELET PIN REMOVING SET

Another handy tool to remove these tough watchband pins.

Item	Order #	Description	12+	6+	1+
E	64-5008	Bracelet Pin Remover	\$18.91	\$20.02	\$22.25
F	64-5009	Replacement Pin	\$1.91	\$2.03	\$2.25

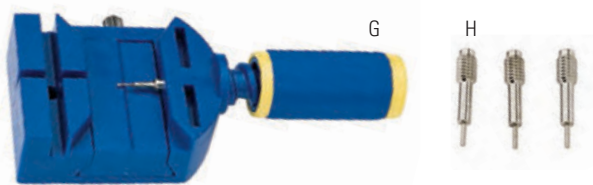

MULTI-FUNCTION WATCH TOOL

This handy tool is perfect for removing watchband pins. Comes with one .80mm pin. The .70mm pin works great for removing links from our Ceramic Couture watches.

Item	Order #	Description	Per Pack	12+	6+	1+
G	59-0807	Multi-Function Watch Tool		\$8.93	\$9.45	\$10.50
H	59-0815	.70mm Replacement Pin Set	(3 pack)	\$5.06	\$5.36	\$5.95
	59-0808	.80mm Replacement Pin Set	(3 pack)	\$5.06	\$5.36	\$5.95

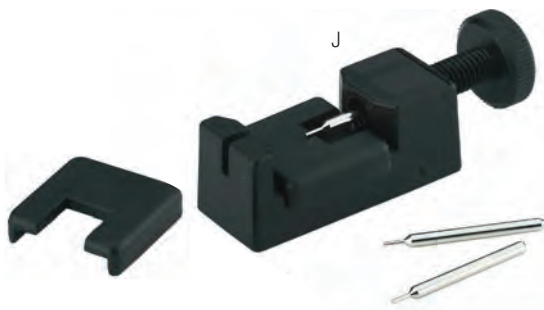

LINK PIN REMOVER

Essential for removing pins from metal link bands. Made of Keltec II glass-filled nylon, this unit includes two extra spacers to accommodate all bracelet sizes and two extra push pins.

Item	Order #	Description	Tip Size	12+	6+	1+
J	59-0810	Link Pin Remover		\$14.41	\$15.26	\$16.95

REPLACEMENT PARTS

	59-0811	Standard Pusher Pin	4 mm	\$2.51	\$2.66	\$2.95
	59-0812	Medium Pusher Pin	7 mm	\$2.51	\$2.66	\$2.95

DELUXE SPRING BAR TOOL

With replaceable stainless steel screw end tips. Used for removal of spring bars from watches.

Item	Order #	Description	12+	6+	1+
A	47-8900	Deluxe Spring Bar Tool	\$4.76	\$5.04	\$5.60
B	47-8910	Pointed Tip	\$1.91	\$2.03	\$2.25
C	47-8911	Forked Tip	\$1.91	\$2.03	\$2.25



BERGEON GAUGE

Handy gauge used to measure crowns and the lengths of spring bars and also to quickly determine width of watchbands.

Item	Order #	Description	12+	6+	1+
D	64-4090	Bergeon Gauge	\$38.25	\$40.50	\$45.00

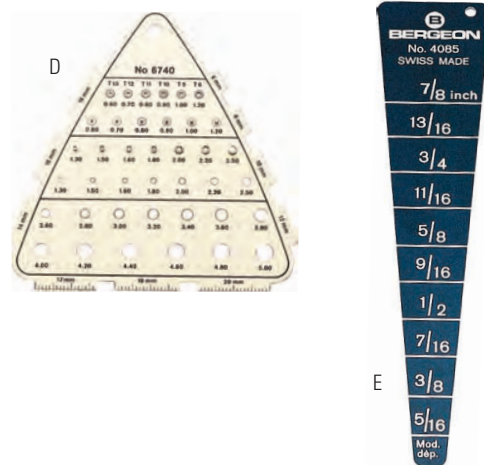

BERGEON SPRING BAR GAUGE

Specially designed tool to gauge the space between case ends in order to select proper size spring bar.

Item	Order #	Description	12+	6+	1+
E	64-4085	Spring Bar Gauge	\$9.31	\$9.86	\$10.95

PIN PUSHER

Tempered steel blade.

Order #	Description	12+	6+	1+
59-0300	Pin Pusher	\$4.55	\$4.82	\$5.35



SPRING BAR TOOL

Used to change spring bars. Features a millimeter scale on handle with screw-in tips.

Item	Order #	Description	12+	6+	1+
F	47-8920	Spring Bar Tool	\$5.06	\$5.36	\$5.95
G	47-8921	Round Tip	\$0.85	\$0.90	\$1.00
H	47-8922	Forked Tip	\$0.85	\$0.90	\$1.00



CASE PRESS WITH METAL DIES

Combination case closer/crystal press features 14 reversible, turned aluminum dies with 28 sizes. Dies screw onto the upper and lower parts so that they can be inverted for case closing or crystal fitting. Cast metal body with angled leverage arm for proper closure.

Order #	Description	12+	6+	1+
59-0797	Combination Case Press	\$38.34	\$40.59	\$45.10





SETTING TOOL FOR WATCH HAND

The professional watchmaker's tool for setting watch hands in face. There are three placers for hour, minute and second hands; works with wrist and pocket watches of all sizes. Also with eight interchangeable hand-holder tips to fit most watch brands and hand styles. The construction of this tool is solid aluminum base and jig, and three spring-loaded chromed-steel placer rods. You will prevent watch damage by using the proper tool for delicate operation. 3¾" L x 2" W x 4½" H

Order #	Description	12+	6+	1+
59-0900	Watch Hand Setting Tool	\$28.90	\$30.60	\$34.00



WIDELY BEZEL OPENER

This bezel opener tool is made of metal and steel and works for watches up to 60mm. It has two pairs of mirror polished blades and an anti-skid case holder mounted on a spring. This Bezel opener has sharply tapered edges, precisely controlled by a large knurled knob. Also special grooves on each side for placing watch. This is a high quality crafted superiorly for allowing you to grip the watch bezel precisely and securely with the flanges on your bench, and then the knob gives you complete control over how you open the bezel, preventing scratching or marring. Great for use on gold watch cases and bezels.

Order #	Description	12+	6+	1+
59-0902	Bezel Opener	\$136.51	\$144.54	\$160.00



BEZEL OPENER

This bezel opener tool works for watches up to 40mm. It has two pairs of mirror polished blades and an anti-skid case holder mounted on a spring. Now you can easily remove watch bezels without risk of damaging them. This bezel remover is ideal for use on gold cases and bezels. The four flanges of the bezel remover have sharply tapered edges, and are controlled by a large knurled knob.

Order #	Description	12+	6+	1+
59-0904	Bezel Opener	\$127.16	\$134.64	\$149.60



CASE OPENER TOOL

The case opener tool is used for removing snap-on case backs. This case opener allows a precise adjustment with an anti-skid case holder mounted on a spring. It comes with two sets of hardened steel blades in sizes 2mm and 4mm, and one delrin die.

Order #	Description	12+	6+	1+
59-0903	Case Opener	\$142.12	\$150.48	\$167.20

MULTI-PURPOSE WATCH STRAP PRESS

Complete system for removing screw-type case bars, band pins, and friction link pins. Made in Switzerland.

Includes:

- One screwdriver with blade
- Nylon case protector
- Pin holder
- Band holder with eight slots
- (2.5mm, 2.75mm, 3.0mm, 3.25mm, 3.5mm, 4.0mm, 4.5mm, 5.0mm)
- Set of seven pins (0.4mm, 0.6mm, 0.7mm, 0.8mm, 1.0mm, 1.5mm, 2.0mm)

Item	Order #	Description	12+	6+	1+
A	59-0805	Watch Strap Press	\$22.10	\$23.40	\$26.00
B	59-0806	Replacement Pins (6 sizes)	\$14.88	\$15.75	\$17.50



LEVERS FOR WATCH HAND

These watch hand removers made of non-magnetic stainless steel. This watch hand remover works as a lever, you put the ends either side and under the hands then just lever off the hands.

Order #	Description	12+	6+	1+
59-0901	Watch Hand Lever	\$12.33	\$13.05	\$14.50



TRANSPARENT DUST COVER

This transparent dust cover will keep your watch parts free of dust. The blue color tray with 6 storage compartments (3 small, 2 large & center round) for easy separation and division. With a durable plastic cover better than the old time glass one. Compact size 4" x 3".

Order #	Description	12+	6+	1+
59-0905	Dust Cover	\$6.55	\$6.93	\$7.70



SCEWDRIVER SET WITH STAND

Eight piece screwdriver set and aluminum stand. The screwdrivers are color coded for quick selection. The set comes complete with replacement blades.

Order #	Description	12+	6+	1+
59-0906	8-Piece Screwdriver Set	\$101.15	\$107.10	\$119.00





DOUBLE SCREW CASE PRESS WITH 24 DIES

This high quality case press will help you with all of your watch repair needs. Reattach the watch backs without worrying about breaking the crystal. Choose from 24 nylon dies to match any watch back.

Order #	Description	1+
59-0793	Watch Case Press	\$279.95



B



C



A

CASE PRESS WITH PLASTIC DIES

The press features 16 reversible dies that include four square dies. Use this tool to close a case back or install a crystal.

Item	Order #	Description	12+	6+	1+
A	59-0796	Combination Case Press with 16 Dies	\$25.46	\$26.96	\$29.95
B	59-0799	Square Dies (set of 4)	\$9.78	\$10.35	\$11.50
C	59-0798	Nylon Round Dies (set of 12)	\$9.78	\$10.35	\$11.50



E



D

CASE PRESS WITH NYLON DIES

D. Made of cast metal to ensure strength. Contains an assortment of nylon dies that will not scratch or mar crystals. Dies snap on and off easily. Configuration is face down which allows the repair person to see the back being closed. Includes 14 dies (7 sizes: 18, 20, 24, 28, 30, 32, and 36 mm).

E. Larger snap-on nylon dies to fit our 59-0795:132008:T. This set is designed for larger oversized watches that are very popular and most have snap-on case backs. There are a total of six pieces three flat on both sides 35 40 and 45mm and three double sided concave that are 40/42.5 45/47.5 and 50/52.5mm concave.

Item	Order #	Description	12+	6+	1+
D	59-0795	Case Press	\$24.65	\$26.10	\$29.00
E	59-0790	Large Nylon Dies	\$15.90	\$16.83	\$18.70



WATCH BRACELET SCREW REMOVER

This great new tool is the only way to go when removing double-ended screws. Made of nearly unbreakable, high-impact glass-filled nylon, this tool features one fixed screwdriver blade and one turnable blade. Blades are tempered steel and both are held fast and perfectly aligned to make removing stubborn screws easy.

Order #	Description	12+	6+	1+
64-5010	Screw Remover	\$16.58	\$17.55	\$19.50

WATCH BAND TOOL KIT

This well-made system is for removing and fitting pins. Constructed with a heavy, plastic band holder and a sturdy wooden base (90 x 80 mm) 5 1/8 x 3 1/4". Includes band holder with eight slots, pin holder with knurled handle (5 mm), a set of six pins (0.4mm, 0.6mm, 0.8mm, 1.0mm, 1.5mm, 2.0mm), and a wooden base. Made in Switzerland.

Order #	Description	12+	6+	1+
59-0804	Watch Band Tool Kit	\$27.16	\$28.76	\$31.95



DELUXE WATCHBAND TOOL SET

Excellent tool for all size watchbands and includes extra pins (0.8mm and 1.0mm) with hand tools.

Item	Order #	Description	12+	6+	1+
A	59-0809	Watch Band Tool	\$23.42	\$24.80	\$27.55

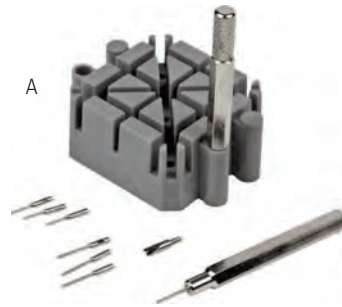

PIN REMOVING KIT

Practical and economical kit for removing friction pins from watch bracelets. Hammer included.

Item	Order #	Description	12+	6+	1+
B	59-0402	Pin Removing Kit	\$16.15	\$17.10	\$19.00



REPLACEMENT PIN PUNCH

Replacement pins for 59-0402 and 59-0809. Can be used with both kits.

Item	Order #	Description	Pin Size	12+	6+	1+
C	59-0405	Replacement Pin Punch	.80 mm	\$4.17	\$4.41	\$4.90
D	59-0406	Replacement Pin Punch	1.0 mm	\$4.17	\$4.41	\$4.90



WOODEN CASE VISE

Will securely hold, and not mar, any waterproof case while the back is being unscrewed.

Order #	Description	12+	6+	1+
64-4079	Wooden Case Vise	\$5.01	\$5.31	\$5.90



SLOT ANVIL

Used as a base for staking, riveting, and drilling small parts. V-Slot is handy for removing pinions and similar items. Case hardened and ground flat and smooth. Has nine graduated holes, with one size for stumps, and five milled slots.

Order #	Description	W x L x H	12+	6+	1+
12-3115	Slot Anvil	1 5/8" x 1 3/4" x 3/4"	\$12.75	\$13.50	\$15.00



HEXAGON ANVIL

Used as a base for staking, riveting, and drilling small parts. Case-hardened and ground flat and smooth. Has 15 holes, graduated from 3/64" to 1/4", and five milled slots.

Order #	Description	W x H	12+	6+	1+
12-3117	Hexagon Anvil	1 5/8" x 3/4"	\$15.90	\$16.83	\$18.70





BERGEON PLASTIC BLOWER

Large capacity, tough plastic air reservoir. Ridges on body preventing rolling. Plastic washer in body is treated to prevent drying out.

Order #	Description	Length	12+	6+	1+
59-0484	Plastic Blower	4½"	\$25.80	\$27.32	\$30.35



DUST BLOWER

Rubber blower that is compact, high quality, and handy to use.

Order #	Description	W x L	12+	6+	1+
23-0900	Dust Blower	1¼" x 3½"	\$4.59	\$4.86	\$5.40



L&R DRYER FOR MOVEMENTS AND PARTS

Place parts or movements directly onto the perforated stainless steel plate, heat will then evaporate the liquid without hurting the mechanism. Drying area is 5½" square. 110V fan motor, and a 300-watt heater. One-year limited manufacturer's warranty.

Order #	Description	W x L x H	1+
58-2650	L&R Dryer	6" x 10" x 4"	\$360.00

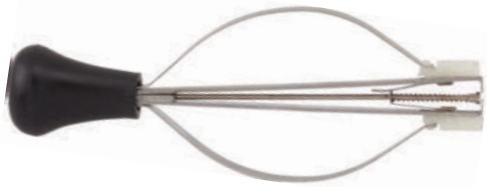

ECONOMY WATCH HAND REMOVER

Removes hands on bracelet watches and small instruments.

Order #	Description	12+	6+	1+
58-2799	Watch Hand Remover	\$6.12	\$6.48	\$7.20

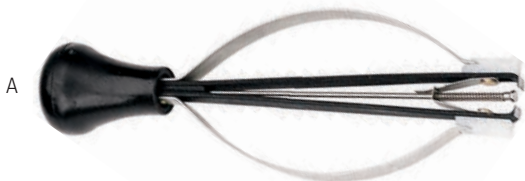

BERGEON PRESTO REMOVER

A. Pusher blocks have fiber tips that will not mar the dial. Jaws retract when side springs are passed. Center plunger holds the hands firmly.

B. Remove both small and sweep second hands from watches. Thin, curved dials and narrow jaws reach down into countersunk dials.



Item	Order #	Description	12+	6+	1+
A	58-2800	#1 Hand Remover	\$58.61	\$62.06	\$68.95
B	58-2801	#6 Second Hand Remover	\$65.03	\$68.85	\$76.50

The online community created
SPECIFICALLY FOR YOU AND YOUR WORLD.



Discover your own global workbench, just a swivel and a click away at BenchJeweler.com. We aim to be the tool you can always count on and the one you will never misplace.

TOP 5 MEMBER BENEFITS

1
FORUMS

2
MEMBERS-ONLY
SALES

3
EDUCATION: VIDEOS
AND ARTICLES

4
EXPERT
TOOLS TEAM

5
PROJECT
GALLERIES

BenchJEWELER.com

powered by  STULLER

HOW TO ORDER

In the continental U.S., orders placed before 5:00 pm (4:00 pm Pacific time) will be shipped the same day. Canadian accounts must place orders by 3:00 pm Canada local time for same day shipping. International accounts must place orders by 2:00 pm CST for same-day shipping. Place orders toll-free by phone, fax, email sales@stuller.com, or on stuller.com.

U.S. and CANADA	INTERNATIONAL
24/7-HOUR FAX: 800-444-4741	24/7-HOUR FAX: 337-981-1655
PHONE: 800-877-7777, and press:	PHONE: 337-262-7700, and press:

- "1" for ordering and pricing
- "2" to establish an account
- "3" for customer services or order tracking
- "4" for account information
- "5" for diamond specialist
- "6" for gemstone specialist
- "8" for Spanish speaking customers (oprime "8" para el español)

To ensure accuracy when placing orders for an item, be prepared to give the following information: account number, account name, your name, complete series number, karat, color, size, quantity, conditional sale number (if applicable).

STULLER.COM

Take advantage of quick and easy ordering and enjoy the following benefits:

- Check current pricing and availability on more than 200,000 SKUs — 24/7, 365 days a year.
- Place orders quickly and accurately.
- Track shipments, view previous orders, and print any of your invoices.
- Use Schedule Order and add to your cart all day and submit your order automatically at your predetermined time.
- Live, text-based chat is available to assist you Monday through Friday, 9:00 am to 6:00 pm CST.
- For WEB ASSISTANCE call 877-619-2174.

Click SIGN UP at the top of stuller.com to create your online account. We'll verify your information and send an email confirmation that your login/password is ready for use. Go to stuller.com, click Login and enter it for full access to the site. Use the Quick Order feature on the home page when you know exactly what you want to order.

SHIPPING INFORMATION

Most items in this catalog are available for same-day shipping, next-day delivery. Ground delivery and motor freight service is available for items that are too large or too heavy for overnight delivery to be cost effective. Your sales consultant will discuss alternative shipping options with you when you order. Freight and insurance are billed at the time of shipment.

• TRUCK SHIPMENTS/UPS/FEDEX

All carriers are responsible and liable for any damages that occur during transit. If you suspect any damage or shortage caused during transit, do not sign freight bill or receipt without making a notation on the freight bill. Retain all packing material and shipping cartons until the carrier has made an inspection. File a claim directly with the carrier within 15 days. Stuller CANNOT file a claim for you. Additional charges for inside delivery, lift gate and COD.

• HAZARDOUS MATERIALS SHIPPING

The Department of Transportation (DOT) governs the labeling, packaging, and handling of certain materials. These standards increase costs from shipping companies for handling (currently an additional \$20–\$30 to each separate package or chemical). Some of your packaging amounts may change. We continually update our shipping policies and try to minimize the DOT charges where possible. Material Safety Data Sheets are sent with all required items and contain important, safety recommendations and emergency procedures. Additional copies are available by contacting Tools Customer Service. Keep on file for quick reference. No returns on hazardous. Must be hazmat certified to return.

CANCELLATIONS AND RETURNS

When ordering online, we encourage you to use the "Schedule Order" feature, which will allow you to make changes to your order prior to it being submitted at your cutoff time.

Once an order has been submitted online, by telephone or fax, you will need to contact a sales associate to determine whether your order can be changed or cancelled.

WHERE AND HOW TO RETURN

We want you to be happy with everything you purchase from us. If you are not satisfied and need to return merchandise, we will give you full credit, provided you follow these procedures (Excludes special ordered, non-returnable items.).

- Return merchandise in its original condition and packaging; including envelopes, bags and boxes. Merchandise should be securely packaged and insured. Stuller is not responsible for returns that are damaged in transit.
- Send the completed Merchandise Return Form or a copy of the original invoice with the returned items. Please include the REASON for return. Merchandise returned without this form or a copy of the invoice may be charged a service fee of \$10.00, or we may return the merchandise to you at your expense.

Product Category	Return Period from Invoice Date
Red Box Diamonds®	10 days
Black Box Gemstones®	10 days
Finished jewelry	10 days
Tools, supplies and packaging	15 days
All other product	30 days
Special orders (Change and Create)	Non-returnable
Stuller Overstock product	Non-returnable
Used tools	Non-returnable
Books, CDs and DVDs	Non-returnable
Custom Imprint Orders	Non-returnable

Customers returning merchandise outside of this time frame will be charged a 15% restocking fee.

Return, insured for full value to:

**Stuller, Inc., Attn: Customer Service
302 Rue Louis XIV, Lafayette, LA 70508**

All returns must be shipped prepaid (no CODs).

Upon receiving your return, we will exchange, replace or credit. You will receive credit in the same manner as you paid for the merchandise.

Stuller is not responsible for returns that are damaged in transit. Items with manufacturing defects may be returned for exchange. Items that were altered, cut or manufactured to your specifications cannot be accepted for credit or exchange. Please keep this in mind when placing your order. For exchanges, we will do an exchange transaction, along with any exchange fee. Be aware that normal shipping charges do apply to the exchange order.

Except for specific Stuller programs that make provisions for "conditional sale" merchandise (finished jewelry, large diamonds and gemstones), products cannot be ordered for review. Such returns will be charged a 15% restocking fee. A 15% restocking fee may also be charged for all returns from accounts that consistently abuse the return privilege.

Refused, undeliverable or merchandise returned that was not purchased from Stuller will be charged for the shipping costs of returning it to you.

Stuller may not be responsible for returned merchandise if these procedures are not properly followed. Thank you for adhering to these policies. If you have any questions concerning the return of merchandise, or credit for the return of merchandise, please contact our Customer Service Department at **800-877-7777**, press 3 or info@stuller.com. Or view stuller.com/returns for further assistance and forms.



Beginning in 2012, the United States and several additional countries around the globe will transition to GHS. Many other regions such as the EU and Japan have already adopted it. What is GHS, and why should you care? To put it simply, **GHS is a standardized system of classifying and labeling hazardous chemicals.** This ground breaking effort will have major implications on the safety, welfare, and environment for the entire world working with chemicals.

JUST THE FACTS ABOUT GHS

What is GHS?

GHS Globally Harmonized System of Classification and Labeling Chemicals

is a standard system for labeling and classifying the hazards in chemicals and for conveying that information in health/data sheets for common global use. GHS was developed by international hazard communication experts.

Why do we need GHS?



Without GHS, every country has a different system for communicating chemical-hazard information, with little or no consistency among the systems. GHS is needed to:



Make all systems consistent for workers handling hazardous chemicals



Reduce costs to governments and companies complying with different systems



Enable better communication of chemical information



Protect workers



Increase international trade

What are the end goals of GHS?

The basic goal of GHS is to standardize the classification rules for hazards, as well as safety data sheets (SDS) and chemical labels.



The aim is to create a system that can be utilized as needed by countries using a building-block approach, or a la carte style.

GLOBAL ADOPTION



Adoption of GHS began back in 1992 when UNICED required a standard practice for labeling chemicals. After 20 years of research, committee meetings, and public hearings, a three-year implementation is scheduled to begin in the US in 2012.

ADOPTION IN THE U.S.

The United States is busily preparing to start transition to GHS in

2012 GHS



Number of Safety Documents Affected



1,000,000 documents for about 1,000,000 chemicals

Number of Companies Affected



5 million+ workplaces

Number of People Affected

40 million+ workers



Number of Years to Transition

3 years from final ruling year - However, training must be completed in 2 yrs



Cost of Adoption

\$97M per year (total)



\$44M - Implementation and Oversight
\$42M - Training
\$11M - SDS Preparation

Safety Outcomes



Prevention of 43 fatalities and 585 injuries and illnesses per year.



Money saved from these reductions = \$266 million per year

Cost Savings

Cost reductions + productivity improvements = **\$585 million per year**



OSHA estimates a net annual savings of **\$754 million per year** from proposed revisions.

What does all this mean? It means that implementing this program only costs **12.8% of the savings per year.**



WHAT'S CHANGING? 5 Areas Affected by Change





1 The new SDS will contain the following 16 sections:

- | | | | |
|--|---|--|---|
| 01  Identification | 02  Hazard(s) identification | 03  Composition/information on ingredients | 04  First-aid measures |
| 05  Fire-fighting measures | 06  Accidental release measures | 07  Handling and storage | 08  Exposure controls/personal protection |
| 09  Physical and chemical properties | 10  Stability and reactivity | 11  Toxicological information | 12  Ecological information |
| 13  Disposal considerations | 14  Transport information | 15  Regulatory information | 16  Other information |

2 Classifications

Label ratings are inverted

OLD

- 1  In current NFPA or HMIS rating systems, "4" is the worst rating, and "1" is the best.
- 2 
- 3 
- 4 

NEW

- 1  However, in GHS nomenclature, "category 1" is the worst.
- 2 
- 3 
- 4 



This can cause confusion during training, which may draw the process out.

3 Labels

There are two signal words in the GHS system: **danger** and **warning**. These signal words are used to communicate the level of hazard on both the label and the SDS.



P&H phrases **Hazard**
Precautionary Statements

Name

MSDS → **SDS**
MSDS is now SDS (Safety Data Sheet)

Classifications

CATEGORY II
CATEGORY III Acute Toxicity
Skin Corrosion RESPIRATORY
CATEGORY IV
CATEGORY I

Standardized GHS pictograms developed -shown with example hazard-









4 Communication/Distribution



5 Training



HOW CAN COMPANIES PREPARE FOR A SUCCESSFUL GHS TRANSITION?

-  **1** Get prepared and be on the lookout for new GHS information.
-  **2** Check implementation dates in your country, plus any you do business with.
-  **3** Create a transition plan for your company.
-  **4** Perform a chemical inventory to validate the chemicals actually present.
-  **5** Put together a plan to acquire, update, and manage the new incoming SDS documents.
-  **6** Update workplace labels according to new regulations.
-  **7** Schedule employee training on new GHS approaches.

NEED MORE INFO?

Visit SiteHawk to stay up to date on all the current GHS information: www.sitehawk.com



Brought to you by:



WEIGHTS AND MEASURES

TO CONVERT	MULTIPLY BY	TO OBTAIN
Centimeters	0.3937	Inches
Cubic Centimeters	0.06102	Cubic Inches
Cubic Inches	16.39	Cubic Centimeters
Cubic Feet	28.32	Cubic Centimeters
Feet	30.48	Centimeters
Feet	0.3048	Meters
Grams	0.64301	Pennyweights (DWT)
Grams	0.03527	Ounces, Avoir
Grams	0.03215	Ounces, Troy
Inches	2.54	Centimeters
Inches	25.4	Millimeters
Kilograms	35.274	Ounces, Avoir
Kilograms	32.1507	Ounces, Troy
Kilograms	643.014	Pennyweights ((DWT))
Kilograms	2.205	Pounds, Avoir
Liters	1.057	Quarts (Liquid)
Meters	3.281	Feet
Meters	39.37	Inches
Meters	1.094	Yards
Millimeters	0.03937	Inches
Ounces, Avoir	28.35	Grams
Ounces, Avoir	.9115	Ounces, Troy
Ounces, Avoir	18.2291	Pennyweights ((DWT))
Ounces, Troy	20	Pennyweights ((DWT))
Ounces, Troy	0.0311	Kilograms
Ounces, Troy	1.0971	Ounces, Avoir
Ounces, Troy	31.1035	Grams
Pennyweights ((DWT))	1.5552	Grams
Pennyweights ((DWT))	0.001555	Kilograms
Pennyweights ((DWT))	0.05486	Ounces, Avoir
Pennyweights (DWT)	0.05	Ounces, Troy
Pounds, Avoir	0.4536	Kilograms
Pounds, Avoir	16	Ounces, Avoir
Pounds, Avoir	14.5833	Ounces, Troy
Pounds, Troy	12	Ounces, Troy
Square Centimeters	0.155	Square Inches
Square Feet	144	Square Inches
Square Inches	6.452	Square Centimeters
Square Inches	645.2	Square Millimeters
Square Millimeters	0.00155	Square Inches
Yard	0.9144	Meters

GRAM WEIGHT

1 gram	=	15.43 grains Troy
1 grain	=	0.0648 grams
1.555 grams	=	1 pennyweight (DWT)
1 grain	=	64.80 milligrams
31.104 grams	=	1 ounce Troy
1 milligram	=	.015432 grams
28.35 grams	=	1 ounce Avoir
1 gram	=	.035274 Avoir oz
1 gram	=	.032151 Troy oz

TROY WEIGHT

Used in weighing precious metals

24 grains	=	1 pennyweight (DWT)
1 kilogram	=	2.68 pounds
20 DWT	=	1 ounce Troy
1 kilogram	=	32.15 Troy ozs
12 ounces	=	1 pound Troy
1 kilogram	=	2.2046 lbs. Avoir
5,760 grains	=	1 pound Troy
1 kilogram	=	35.2740 oz. Avoir
480 grains	=	1 Troy oz
1 kilogram	=	15,432 grains
Troy oz	=	1.0972 Avoir oz

AVOIRDUPOIS WEIGHT

Used in weighing base metals

16 drams (or drachms)	=	1 oz Avoir
1 pound Avoir	=	14.5833 Troy oz
16 ounces	=	1 pound Avoir
1 ounce Avoir	=	0.914 Troy oz
16 ounces	=	7,000 grains
1 pound Avoir	=	7,000 grains
28 pounds	=	1 quarter English
1 ounce Avoir	=	437.5 grains
4 quarters	=	1 hundredweight (cwt.)
1 pound Avoir	=	.4359 kilo
20 hundredweight	=	1 ton Avoir

CIRCLES AND SQUARES CIRCUMFERENCES/AREAS

Rules relating to circles and squares

The circumference of a circle is the diameter times 3.1416. The area of a circle is the radius squared times 3.1416.

The area of a square is the length of one side squared.

SIZE IN INCHES	CIRCUMFERENCE OF CIRCLE (IN)	AREA OF CIRCLE	AREA OF SQUARE
1	3.142	.7854	1.000
2	6.283	3.142	4.000
3	9.425	7.069	9.000
4	12.57	12.57	16.00
5	15.71	19.64	25.00
6	18.85	28.27	36.00
7	21.99	38.48	49.00
8	25.13	50.27	64.00
9	28.28	63.62	81.00
10	31.42	78.54	100.00
11	34.56	95.03	121.00

TEMPERATURE CONVERSION

Conversion Formulas °F = (9/5 x °C) + 32° °C = 5/9 (°F - 32°)

°F	°C	°F	°C	°F	°C	°F	°C	°F	°C	°F	°C
600	316	830	443	1120	604	1410	766	1640	893	1930	1054
610	321	840	449	1130	610	1420	771	1650	899	1940	1060
620	327	850	454	1140	616	1430	777	1660	904	1950	1066
630	332	860	460	1150	621	1440	782	1670	910	1960	1071
640	338	870	466	1160	627	1450	788	1680	916	1970	1077
650	343	880	471	1170	632	1460	793	1690	921	1980	1082
660	349	890	477	1180	638	1470	799	1700	927	1990	1088
670	354	900	482	1190	643	1480	804	1710	932	2000	1093
680	360	910	488	1200	649	1490	810	1720	938	2010	1099
690	366	920	493	1210	654	1500	816	1730	943	2020	1104
700	371	930	499	1220	660	1510	821	1800	982	2030	1110
710	377	1000	538	1230	666	1520	827	1810	988	2040	1116
720	382	1010	543	1240	671	1530	832	1820	993	2050	1121
730	388	1020	549	1250	677	1540	838	1830	999	2060	1127
740	393	1030	554	1260	682	1550	843	1840	1004	2070	1132
750	399	1040	560	1270	688	1560	849	1850	1010	2080	1138
760	404	1050	566	1280	693	1570	854	1860	1016	2090	1143
770	410	1060	571	1290	699	1580	860	1870	1021	2100	1149
780	416	1070	577	1300	704	1590	866	1880	1027	2110	1154
790	421	1080	582	1310	710	1600	871	1890	1032	2120	1160
800	427	1090	588	1320	716	1610	877	1900	1038	2130	1166
810	432	1100	593	1330	721	1620	882	1910	1043		
820	438	1110	599	1400	760	1630	888	1920	10		

Conversion Charts

GAUGES TO INCHES TO MILLIMETERS

B & S GAUGE	INCH DECIMAL	MILLIMETER	INCH FRACTION
2	.0258	6.543	—
—	0.250	6.350	1/4
—	0.234	5.953	15/64
3	0.229	5.827	—
—	0.219	5.556	7/32
4	0.204	5.189	—
—	0.203	5.154	11/64
—	0.188	4.762	3/16
5	0.182	4.621	—
—	0.172	4.366	11/64
6	0.162	4.115	—
—	0.156	3.969	5/32
7	0.144	3.664	—
—	0.141	3.572	9/64
8	0.128	3.263	—
—	0.125	3.175	1/8
9	0.114	2.906	—
—	0.109	2.778	7/64
10	0.102	2.588	—
—	0.094	2.381	3/32
11	0.091	2.304	—
12	0.081	2.052	—
—	0.078	1.984	5/64
13	0.072	1.828	—
14	0.064	1.628	—
—	0.063	1.588	1/16
15	0.057	1.449	—

B & S GAUGE	INCH DECIMAL	MILLIMETER	INCH FRACTION
16	0.051	1.291	—
—	0.047	1.191	3/64
17	0.045	1.149	—
18	0.040	1.024	—
19	0.036	0.912	—
20	0.032	0.812	—
—	0.031	0.795	1/32
21	0.028	0.723	—
22	0.025	0.644	—
23	0.023	0.573	—
24	0.020	0.511	—
25	0.018	0.455	—
26	0.016	0.405	—
—	0.016	0.396	1/64
27	0.014	0.360	—
28	0.013	0.321	—
29	0.011	0.286	—
30	0.010	0.255	—
31	0.009	0.226	—
32	0.008	0.200	—
33	0.007	0.180	—
34	0.006	0.160	—
35	0.006	0.142	—
36	0.005	0.130	—
37	0.005	0.114	—
38	0.004	0.100	—

<p>ABRASIVES 4-35</p> <p>Bands Inside Ring Polisher Grinder Rolls Shells Sticks Paper Pads Sponges Unitized Wheels Cut-Off Discs Snap-On Discs Pinhole Discs MOUNTED Abrasive Stones Diamond Impregnated Stones Ceramic Dressing Stones MOUNTED Abrasive Stones Diamond Impregnated Stones Ceramic Dressing Stones MOUNTED Silicon Wheels UNMOUNTED Silicon Wheels Rubber Polishers Acrylic Polishers Air flex Polishers MX Polishers Flap Wheels Platinum Polishers Gold Polishers Gem Polishers Titanium Polishers Steel Polishers Ceramic Polishers Pumice Polishers Miniature Mandrels Sanding Mandrels Wheel Arbor Mandrels Bushing Mandrels</p>	<p>Thank you Envelopes Watch Forms Jewelry Forms</p>	<p>Cutters Spiral Maker Counters Easy Ear Wire Lamps Beading Kits Utility Boxes Trays Bead Boards Mats Thread Burner Knotter</p>	<p>Diamond Burs and Discs Flywheels Inside Ring Burs Cup Burs Wax Burs</p>
<p>ADHESIVE 36-39</p> <p>Super Glue Epoxy Stringing Glue Acetone Dissolving Compound</p>	<p>BATTERIES 44-52</p> <p>Cell <i>Watch</i> <i>AA</i> <i>AAA</i> <i>C</i> <i>D</i> <i>9V</i></p> <p>Hearing Aid <i>Easy Change</i></p> <p>Rechargeable <i>AA</i> <i>AAA</i> <i>C</i> <i>D</i> <i>9V</i></p> <p>Chargers <i>Battery</i> <i>Phone</i> <i>iPad</i></p> <p>Battery Kits Flashlights Testers Analyzers Parts Pads Checkers</p>	<p>BENCHES AND BENCH TOOLS 78-98</p> <p>Benches Tool Holder Benchmate Systems Clamps Holders Bench Pins Rollers Lifters Pushers Knives Scrapers Burnishers Bench Blocks Chasing Tools Beading Milgrain Tools Setting Compounds Anvils Vises</p>	<p>CASTING 134-191</p> <p>Milling Wax Carving Wax Forming Wax Componentry Wax Wax Wire Repair Wax Wax Solvent Curing Lamps Sprue Wax Injection Wax Matt Wax tools Wolf Wax Tools Wax Templates Wax Files Dividers Mandrels Wax Pens Mold Rubber 2-Part Silicone Kits Mold Frames Sprue Burnishers & Formers Sprue Base Flask and Extenders Sprue Sleeves Investment Vac-U-Cast Vacuum Pumps Mixing Bowls Investment Scales Furnaces Controllers Electro Melts Fume Hood Torches Flashback Arrestors Crucibles String Rods Ingot Molds Flux Safety Glasses Casting Grain Bead Blasters Glass Beads</p>
<p>BAGS AND ENVELOPES 40-43</p> <p>Red-Line Bags Green-Line Bags Write-On Bags Corrosion Free Bags and Strips Repair Envelopes Job Envelopes</p>	<p>BEADING AND STRINGING SUPPLIES 53-77</p> <p>Bead Cord Wire Needles Artistic Wire Memory Wire Cable Crimp Beads Crimp Tubes Scrimps End Caps Bead Tips Wire Guardian Bead Bumpers Silk Cord Spools Awls Bead Tweezers Reamers Shears Pliers Scissors</p>	<p>BRUSHES 99-107</p> <p>MOUNTED Bristle Brushes UNMOUNTED Bristle Brushes Wire Bristle End Brushes Wood Metal Hub Brushes Spindle Adaptors Mandrels Red Sable Scratch Flux Brushes Brass Stainless Steel Bench Multi-Purpose Brushes</p>	<p>BURS 108-133</p> <p>Panther Bur Kits and Individuals Busch Bur Kits and Individuals Bur Holders</p> <p>CLEANING 192-209</p> <p>Hand Cleaners Jewelry Cleaners</p>

CLEANING continued

Drain Traps
 Steam Tweezers
 Racks
 Diamond Wash Jar
 Steamers
 Steamer Additives
 Ultrasonics
 Solutions
 Holders and Baskets
 Sinks

**DRILLS AND PUNCHES
 210-219**

Titanium
 Tungsten Carbide Twist Drills
 Cobalt Twist Drills
 Diamond Coated Core Drills
 Diamond Drill Press
 Diamond Drill Vise
 Center Punches
 Lubricants
 Pen Vises
 Preform Kits
 Pearl Drills
 Pearl Holders
 Pearl Drilling Machine

**ENGRAVING
 220-251**

Laser Engraving
 Computerized Engraving
 Inside/ Flat Engraving
 Dials/Blocks/Script Lettering
 Power Gravers
 Compressors
 Bench Microscopes
 Microscope Accessories
 Engraving Blocks
 Block Accessories
 Practice Rings/Sheets
 Shellac Holders
 Shellac/Cements
 Tracers
 Scribes
 Sharpening Systems
 Graver Trays/Holders
 Graver Templates
 Gravers
 High Speed
 Quick Change
 Carbon-Steel Gravers
 Muller High Speed/Straight Line
 Square/Flat Gravers
 Magna Gravers
 Graver Handles
 Graver Lube
 Bench Stones
 Sharpeners

FILES

252-265
 Rotary Files
 Hand Files
 Needle Files
 Escapement Files
 Single Cut Needle Files
 File Cleaner
 Wax Files
 File Sets
 Double-Ended Files
 Diamond Files
 Utility Files/Broaches
 File Handles

**FLEX SHAFTS
 266-279**

Foredom Motor Kits
 Motors Only
 Foredom Motor Parts/Hangers
 Grobet Motor Kits
 Grobet Handpieces/Hangers
 Handpieces
 Air Scribe
 Compressor/Hook-up Kits
 Wolf Belt Sander/Sanding Belts
 Micromotors
 Allset Kits
 Brill Presses
 Vises

**GAUGES AND MANDRELS
 280-292**

Dial/Digital Stone Gauges
 Calipers
 Dividers
 Sliding Gauges
 Rulers
 Stone Gauges
 Diamond Sieves/Holders
 Bracelet Gauges
 Ring Finger Gauges
 Ring Mandrels
 Specialty Mandrels
 Bezel Mandrels
 Bracelet/Wood Mandrels
 Miniature/Expandable Mandrels

**GEMOLOGICAL
 INSTRUMENTS
 293-303**

GIA Microscopes
 Dazor SpeakFINDER
 Polariscope/Dichroscoppe
 Spectroscope
 Chelsea Colour Filter Loupe
 Gemoro Scopes
 LED Lamp
 Color CZ Set
 Diamond Colorimeter

Grading Light
 Display Rings
 Sorting Trays
 Stone Papers/Trays
 Parcel Containers

**HAMMERS
 304-311**

Fretz Hammers and Anvils
 Planishing
 Embossing
 Raising
 Ball Peen
 Goldsmith Hammers
 Brass
 Nylon
 Chasing Hammers
 Mallets
 Forming Stakes

**LAMPS
 312-317**

Bench
 LED
 Desk Lamps
 Magnification Lamps
 Light Boxes

**LOUPES AND MAGNIFIERS
 318-329**

loupe Cords
 Lighted Loupes
 Triplet Loupes
 Diamond Stone Loupes
 Magnifier
 Visors
 Reading Magnifiers

**METALS
 330-373**

Grain
 Casting Alloy
 Sheet
 Strip
 Wire
 Flat Sizing Stock
 Triangle Sizing Stock
 Bezel Stock
 Twist Wire
 Pattern Wire
 Tubing
 Solder
 Stamping

**METAL DRAWING
 AND FORMING
 374-386**

Rolling Mills
 Stands
 Draw Tools

Bench
 Plates
 Jewelry Marking
 Stamps
 Stamp Anvils
 Dapping Tools
 Punches
 Forming Blocks
 Copola Sets
 Tap and Die Sets
 Bezel Blocks/Punches

**PLATING
 387-402**

Plating Kits
 Hoods
 Plating Solutions
 Rhodium Solutions
 Pen Solutions
 Palladium Solutions
 Rectifiers
 Anodes
 Beakers
 Test Kits
 Carbon Treatment Kit
 Hot Plates
 Plating Racks
 Thermometer
 Plating Wire
 Electro Cleaner
 Activator
 Pen Plating Systems
 Antiquing Solution
 Lacquer Solution
 Alcohol
 Acid Neutralizer
 Gloves
 Aprons
 Post Protectors
 Ceramic
 U-Name!

**PLIERS, CUTTERS,
 AND SHEARS
 403-429**

Tronix Pliers
 Teborg Pliers
 Ideal-Tek Pliers
 Lindstrom Pliers
 Reverse Pliers
 Slim-Line Pliers
 Xuron Pliers
 Stuller Pliers
 Specialty Pliers
 Forming Pliers
 Plier Tool kits
 Parallel Pliers
 Bending
 Gem Setting
 Opening

<p>Lifting Closing Pliers Setting Pliers Hole Punch Pliers Ring Cutters Sprue Cutters Wire Cutters and Shears Scissors Snips Guillotine's</p>	<p>Welding Glasses Ear Plugs Sweatbands Welding Gloves Latex Gloves Kevlar Gloves Nitrile Gloves Respirators Filters Cartridges Aprons Skin Protection Ring Guards Slide Ring Eye Wash Signs Eye Wash Stations Finger Tape Finger Protection</p>	<p>Caddy Kits Casting Torches Torch Tips Hose Connectors Check Valves Arrestors Soldering Pads Soldering Stations Ring Stands Tripod with Screen Annealing Pans Torch Lighters Tweezers Clamps Fingers Third Hands Binding Wire Solder Picks Torch Stands Flux Bottles Firescoff Magic Flame Boric Acid Borax Powder Pickling Flux Solder Dip Solder Chemical Shields Pickle Liquids/Granular Pickle Pots Solder Fume Systems Hydro flux Welders Safety Glasses Aprons Gloves Laser Welders Laser Accessories Spot Welders Solder Sheet Laser Wire</p>	<p>Cyber Threm Tip Tweezers Ring Soldering Tweezers Plastic Tweezers Copper Tongs Steam Tweezers Split Ring Tweezers Diamond Holding Tweezers</p>
<p>POLISHING 430-471 Polishing Workstation Double and Single Polishing Units Polishing Unit Accessories Bench-top Polishers Dust Collection Units Polishing Accessories Collection Units Lap Machines Lap Wheels Polishing Motors Spindles Mandrels Adaptors Chucks Rouge Bufs Buff and Rouge Kits Felt Wheels Felt Bufs Specialty Bufs Satin Finish Bufs Finger Tape Pads Guards Respirators Polishing Cloths Gloves Tumblers Steel Shot Liquid Compound Conditioner Polishing Media</p>	<p>SAW BLADES AND FRAMES 482-487 Saw Blades Flat Blades Spiral Blades Diamond Blades Jig Cutters Metal Saw Bench Holder Tub Cutter Saw Frames</p>	<p>TESTERS 530-537 Gemlogis Testers Gemoro Testers Ceres Testers Metal Testers AGT Testers</p>	<p>VIDEO AND BOOKS 549-553 Beading Casting Design Educational Engraving Gemological Metal Smithing Pearls Setting Watch Repair Wax</p>
<p>RING SIZERS AND STRECHERS 472-473 Ring Stretchers/Reducers Ring Roller Ring Bender Ring Cutter</p>	<p>SCALES 488-495 Diamond Weighing Scales Gold Scales Scales Charts Info A&D Scales Ohaus Scales Citizen Scales Gemoro Scales Tinita Scales Weights</p>	<p>TWEEZERS 538-548 Ideal-Tek Tweezers Dumont Tweezers Non-Magnetic Tweezers Diamond Tweezers Inox Tweezers Pattern Tweezers Utility Tweezers Solder Tweezers Cross Locking Tweezers Pearl and Beading Tweezers</p>	<p>WATCH TOOLS AND SUPPLIES 554-579 Gasket Assortment Adhesives Crystal Compounds Crystal Repair Kits Watch Cleaning Solutions Stem and Gear Lubricants Oiler/Blower/Brushes Dryers/Lint Tissues Parts Holder Movement Trays Optical Screws Demagnetizers Screwdriver Sets Anvils Bench Plate Watch Bench Bench Knives Case Openers Case Closers Watch Pen Removing Tools Cotter Pin Assortment Bracelet Pin Assortment EZ Change Pins Watch Hand Removing Tools Spring Bar Tools Gauges Spring Bar Kits Individual Bars</p>
<p>SAFETY SUPPLIES 474-481 Safety Glasses Goggles Ring Cracker Shields</p>	<p>SCREWDRIVERS 496-499 Screwdriver Sets Individuals Multi-Purpose Sets Mini Sets Sharpeners Holders</p> <p>SOLDERING SUPPLIES AND TORCHES 500-529 Torch Kits Regulators Hoses Welding Tanks</p>		

Series Index

BEZEL	354	2770	506	23384	506	10-6090	6	10-7105	18	10-8164	14
BEZEL	358	3113	366	23406	506	10-6091	6	10-7106	18	10-8165	14
EBAT	44	3125	368	23701	62	10-6092	6	10-7107	18	10-8166	14
EBAT	46	3133	370	23752	64	10-6093	6	10-7108	18	10-8167	14
EBAT1.5V	48	3161	370	23753	64	10-6094	6	10-7120	18	10-8168	14
EBAT101	48	3164	368	23754	64	10-6095	6	10-7121	18	10-8173	14
EBAT12V	48	3251	368	23822	66	10-6100	4	10-7122	18	10-8174	14
EBAT9V	48, 50	3251	370	23 850	66	10-6102	4	10-7125	18	10-8175	14
EBATAA	48, 50	3252	370	23853	66	10-6103	4	10-7130	276	10-8176	14
EBATAAA	48, 50	3288	368	23857	66	10-6104	4	10-7140	18	10-8177	14
EBATAAAA	48	3291	370	23858	66	10-7000	16	10-8071	264	10-8178	14
EBATBASIC	44	3297	370	23860	66	10-7001	16	10-8075	4	10-8181	32
EBATC	48, 50	3332	368	24034	62	10-7002	16	10-8076	4	10-8182	32
EBATCHARGER	50	3382	370	24035	62	10-7005	16	10-8077	4	10-8183	32
EBATD	48, 50	3385	370	24036	66	10-7006	16	10-8078	4	10-8188	104
EBATHA	48	3388	368	24038	66	10-7007	16	10-8079	4	10-8190	34
EBATPAD	48	3390	370	24039	66	10-7010	16	10-8081	4	10-8191	34
EBATSP	44	3395	370	24055	64	10-7011	16	10-8082	4	10-8192	34
GRAIN	330, 332	3396	370	24056	64	10-7012	16	10-8090	4	10-8193	34
LA-499	554	3397	370	24057	62	10-7015	16	10-8091	4	10-8208	32, 442
LA-500	554	3398	370	24058	62	10-7016	16	10-8092	4	10-8270	34
LA-501	554	3423	366	24059	62	10-7017	16	10-8093	4	10-8272	34
LA-502	554	3449	366	24143	62	10-7020	16	10-8094	4	10-8274	34
LA-503	554	3452	366	24213	64	10-7021	16	10-8100	4	10-8275	34
LA-504	554	3455	366	24283	64	10-7022	16	10-8101	4	10-8320	14
LA-505	554	3471	366	24313	64	10-7025	16	10-8102	4	10-8321	34
PATTERN WIRE	358	3479	366	24314	64	10-7026	16	10-8103	4	10-8322	34
RBAT	46	3483	366	24359	62	10-7027	16	10-8104	4	10-8324	212
RBAT101	46	3487	368	24360	62	10-7030	18	10-8105	4	10-8325	212
RD1	66	3496	368	24904	64	10-7031	18	10-8106	4	10-8326	212
RD2	66	3507	368	24905	64	10-7032	18	10-8107	4	10-8330	212
RD3	66	3521	368	24908	64	10-7033	18	10-8108	4	10-8331	212
RING BLANK	356	3522	368	24912	64	10-7034	18	10-8109	4	10-8340	10
SHEET	334	3526	368	24913	64	10-7035	18	10-8110	4	10-8342	10
SIZING STOCK	348, 350,	3527	368	24914	64	10-7036	18	10-8111	4	10-8343	10
	352, 354	3537	368	24915	64	10-7037	18	10-8112	4	10-8344	10
SLIT COIL	356, 358	3545	368	28096	556	10-7038	18	10-8113	4	10-8407	4
SOLDER	358, 360	3732	370	28134	556	10-7039	18	10-8114	4	10-8408	4
	362, 364	3733	370	28145	556	10-7040	18	10-8115	4	10-8409	4
SPEEDWIRE	348	3734	370	28171	556	10-7041	18	10-8116	4	10-8410	4
SR5	66	3736	370	28293	64	10-7042	18	10-8117	4	10-8415	8
SR5.5	66	3737	370	28294	64	10-7043	18	10-8120	34	10-8416	8
SR6	66	3739	370	28506	64	10-7044	18	10-8121	34	10-8417	8
SR7	66	3742	370	10-1077	18	10-7050	18, 32	10-8122	6	10-8418	8
STRIP	340	3787	370	10-1078	18	10-7060	32	10-8123	6	10-8420	4
TUBING	354, 356	3788	366	10-1079	18	10-7061	32	10-8124	6	10-9098	16
WIRE	342, 344,	3902	370	10-4080	28	10-7062	32	10-8125	6	10-9099	16
	346, 348	3903	370	10-4203	240	10-7063	32	10-8126	6	10-9100	16
	350, 352,	3904	370	10-4204	240	10-7064	32	10-8127	32	10-9101	16
	358	20312	62	10-4210	240	10-7065	32	10-8128	32	10-9102	16
34	276	20313	62	10-4500	240	10-7070	34, 458	10-8131	6	10-9103	16
94	64	20342	62	10-4510	240	10-7071	34, 458	10-8132	6	10-9104	14
101	64	20999	64	10-4550	10	10-7072	34, 458	10-8140	14	10-9104	500
102	64	21459	506	10-4551	10	10-7073	34, 458	10-8141	14	10-9105	16
109	64	21460	506	10-4552	10	10-7074	34, 458	10-8142	14	10-9106	16
262	62	21461	506	10-4553	10	10-7075	34, 458	10-8143	14	10-9107	16
263	62	22467	66	10-4554	10	10-7076	34, 458	10-8150	6	10-9108	16
863	64	22470	64	10-4555	240	10-7080	452	10-8151	6	10-9109	16
864	64	22485	64	10-5510	240	10-7090	452	10-8152	6	10-9110	16
865	64	22532	64	10-5520	240	10-7100	18	10-8153	6	10-9111	16
866	64	22629	64	10-6000	4	10-7101	18	10-8155	6	10-9112	16
867	64	22630	64	10-6008	240	10-7102	18	10-8160	34	10-9113	16
2305	506	23040	2	10-6010	240	10-7103	18	10-8161	34	10-9114	16
2306	506	23373	64	10-6015	240	10-7104	18	10-8162	34	10-9115	14

10-9116	14	11-0904	130	11-3526	8	11-6026	20	11-6126	24	11-6221	30
10-9117	14	11-0906	130	11-3527	8	11-6027	20	11-6127	24	11-6222	30
10-9130	16	11-0907	130	11-3528	8	11-6028	20	11-6128	24	11-6223	30
10-9131	16	11-0908	130	11-3529	8	11-6029	20	11-6129	24	11-6244	30
10-9132	16	11-0909	130	11-3540	278	11-6030	20	11-6130	24	11-6245	30
10-9133	16	11-0910	130	11-3541	278	11-6031	20	11-6131	24	11-6246	30
10-9134	16	11-0915	130	11-4260	28	11-6032	20	11-6135	24	11-6247	30
10-9135	16	11-0916	130	11-4261	28	11-6033	20	11-6136	24	11-6248	30
10-9136	16	11-2203	6	11-4270	28	11-6034	20	11-6137	24	11-6249	30
10-9140	16	11-2204	6	11-4271	28	11-6040	20	11-6138	24	11-6250	34
10-9141	16	11-2205	6	11-4280	28	11-6041	20	11-6139	24	11-6251	34
10-9142	16	11-2660	6	11-4281	28	11-6042	20	11-6140	24	11-6252	34
10-9143	16	11-3008	32	11-4290	28	11-6043	20	11-6141	24	11-6253	34
10-9144	16	11-3009	32	11-4291	28	11-6044	20	11-6145	24	11-6255	34
10-9145	16	11-3010	32	11-4300	28	11-6045	20	11-6146	24	11-6256	34
10-9146	16	11-3060	6	11-4301	28	11-6046	20	11-6147	24	11-6257	34
10-9162	16, 442	11-3100	6	11-4310	28	11-6047	20	11-6148	24	11-6260	28
10-9163	16, 442	11-3101	6	11-4311	28	11-6048	20	11-6149	24	11-6261	28
11-0651	40	11-3102	6	11-4320	28	11-6049	20	11-6150	24	11-6262	30
11-0652	40	11-3103	6	11-4321	28	11-6052	20	11-6151	24	11-6263	30
11-0700	10	11-3110	6	11-4330	28	11-6060	22	11-6155	24	11-6264	30
11-0701	10	11-3200	6	11-4331	28	11-6061	22	11-6156	24	11-6265	30
11-0702	10	11-3201	6	11-4340	28	11-6062	22	11-6157	24	11-6266	30
11-0703	10	11-3202	6	11-4341	28	11-6063	22	11-6158	24	11-6267	30
11-0704	10	11-3203	6	11-4350	28	11-6064	22	11-6159	24	11-6268	30
11-0705	10	11-3204	6	11-4351	28	11-6065	30	11-6160	24	11-6269	30
11-0706	10	11-3205	6	11-4360	28	11-6072	30	11-6165	24	11-6270	30
11-0707	10	11-3206	6	11-4361	28	11-6074	30	11-6166	24	11-6271	30
11-0708	10	11-3330	6	11-4370	28	11-6080	22	11-6167	24	11-6272	30
11-0709	10	11-3390	8	11-4371	28	11-6081	22	11-6168	24	11-6273	30
11-0710	10	11-3391	8	11-4380	28	11-6082	22	11-6169	24	11-6274	30
11-0711	10	11-3392	8	11-4381	28	11-6083	22	11-6171	24	11-6275	30
11-0720	12	11-3400	8	11-4390	28	11-6084	22	11-6172	26	11-6276	30
11-0721	12	11-3401	8	11-4391	28	11-6085	22	11-6175	24	11-6277	30
11-0722	12	11-3402	8	11-4400	28	11-6086	22	11-6176	24	11-6280	30
11-0723	12	11-3403	8	11-4401	28	11-6087	22	11-6177	24	11-6281	30
11-0724	12	11-3404	8	11-5100	18	11-6088	22	11-6178	24	11-6282	30
11-0725	12	11-3405	8	11-5102	18	11-6090	26	11-6179	24	11-6283	30
11-0726	12	11-3406	8	11-5103	18	11-6091	26	11-6181	24	11-6290	30
11-0730	12	11-3408	8	11-5104	18	11-6092	26	11-6185	24	11-6291	30
11-0731	12	11-3420	10	11-5105	18	11-6093	26	11-6186	24	11-6292	30
11-0732	12	11-3421	10	11-5106	18	11-6094	26	11-6187	24	11-6293	30
11-0736	12	11-3422	10	11-5107	18	11-6095	26	11-6188	24	11-6294	30
11-0737	12	11-3423	10	11-6000	20	11-6096	26	11-6189	24	11-6295	30
11-0739	12	11-3424	10	11-6001	20	11-6100	20	11-6190	24	11-6296	30
11-0740	12	11-3425	10	11-6002	20	11-6101	20	11-6191	24	11-6297	30
11-0741	12	11-3426	10	11-6003	20	11-6102	20	11-6192	24	11-6300	28
11-0745	12	11-3427	10	11-6004	20	11-6103	20	11-6193	26	11-6301	28
11-0746	12	11-3428	10	11-6005	20	11-6105	20	11-6194	24	11-6302	28
11-0747	12	11-3429	10	11-6006	20	11-6106	20	11-6195	26	11-6303	28
11-0750	12	11-3430	8	11-6007	20	11-6107	20	11-6196	26	11-6304	28
11-0751	12	11-3431	8	11-6008	20	11-6108	20	11-6197	26	11-6305	28
11-0752	12	11-3500	8	11-6009	20	11-6110	20	11-6198	26	11-6307	28
11-0753	12	11-3501	8	11-6012	20	11-6111	20	11-6199	26	11-6308	28
11-0754	12	11-3502	8	11-6013	20	11-6112	20	11-6200	30	11-6310	28
11-0755	12	11-3503	8	11-6014	20	11-6113	20	11-6201	30	11-6312	28
11-0756	12	11-3504	8	11-6015	20	11-6115	20	11-6202	30	11-6313	28
11-0757	12	11-3505	8	11-6016	20	11-6116	20	11-6203	30	11-6315	28
11-0758	10	11-3520	8	11-6017	20	11-6117	20	11-6204	30	11-6316	28
11-0800	12	11-3521	8	11-6018	20	11-6118	20	11-6210	30	11-6317	28
11-0900	130	11-3522	8	11-6019	20	11-6120	20	11-6211	30	11-6318	28
11-0901	130	11-3523	8	11-6020	20	11-6121	24	11-6212	30	11-6320	28
11-0902	130	11-3524	8	11-6021	20	11-6124	24	11-6213	30	11-6322	28
11-0903	130	11-3525	8	11-6025	20	11-6125	24	11-6220	30	11-6324	22

Series Index

11-6325	22	11-8045	12	12-2053	562	13-1721	314	14-0021	508	14-0769	184, 514
11-6326	22	11-8098	276	12-2054	560	13-1723	314	14-0022	508	14-0770	184, 514
11-6327	22	11-8100	20	12-2056	38	13-1792	312	14-0024	508	14-0771	514
11-6328	22	11-8110	20	12-2080	246	13-1798	314	14-0025	508	14-0772	514
11-6329	22	11-8114	22	12-2100	562	13-1799	312	14-0090	508, 512	14-0777	516
11-6330	22	11-8116	22	12-2111	36	13-1800	312	14-0092	512	14-0778	516
11-6331	22	11-8118	22	12-2112	36	13-1801	312	14-0110	500	14-0779	516
11-6333	22	11-8120	22	12-2113	36	13-1802	312	14-0115	500	14-0780	516
11-6334	22	11-8122	22	12-2114	36	13-1803	312	14-0116	500	14-0781	516
11-6335	22	11-8124	22	12-2115	38	13-1805	312	14-0117	500	14-0782	514, 516
11-6336	22	11-8126	22	12-2117	36	13-1806	312	14-0120	500	14-0806	506
11-6350	26	11-8134	22	12-2118	36	13-1808	312	14-0121	500	14-0811	502
11-6351	26	11-8136	22	12-2120	36	13-1810	312	14-0122	500	14-1002	504
11-6353	26	11-8138	22	12-2121	38	13-1814	312	14-0123	500	14-1015	508
11-6354	26	11-8140	22	12-2124	70	13-1817	312	14-0124	500	14-1016	508
11-6356	26	11-8142	22	12-2127	70	13-1818	316	14-0125	500	14-1017	508
11-6357	26	11-8144	22	12-2131	38	13-1819	316	14-0127	500	14-1024	508
11-6360	26	11-8146	22	12-2132	38	13-1820	312	14-0128	500	14-1025	508
11-6361	26	11-8148	22	12-2135	38	13-1821	312	14-0129	500	14-1026	508
11-6362	26	11-8150	22	12-2136	36	13-1823	78	14-0130	500	14-1220	508
11-6363	26	11-8152	22	12-2137	36	13-1823	312	14-0132	500	14-1300	508
11-6364	26	11-8154	22	12-2138	36	13-1824	312	14-0133	500	14-1301	508
11-6366	26	11-8156	22	12-2270	94, 244	13-1825	312	14-0135	500	14-1302	508
11-6367	26	11-8158	22	12-2280	94, 246	13-1826	312	14-0136	500	14-1303	508
11-6368	26	11-8162	22	12-2281	94	13-1828	292	14-0140	502	14-1306	508
11-6369	26	11-8164	32	12-2288	94, 246	13-1829	312	14-0141	502	14-1307	508
11-6370	26	11-8166	32	12-2292	94	13-1831	312	14-0143	502	14-1308	508
11-6371	26	11-8168	32	12-2300	246	13-1832	312	14-0145	502	14-1309	508
11-6372	26	11-8170	32	12-3010	96	13-1833	312	14-0146	220	14-1402	508
11-6373	26	11-8172	22	12-3015	96	13-1834	312	14-0147	220	14-1403	508
11-6374	26	11-8174	22	12-3050	96	13-1840	296	14-0148	220	14-1404	508
11-6375	26	11-8180	28	12-3107	96	13-2010	314	14-0149	220	14-1500	504
11-6376	26	11-8182	28	12-3109	96	13-2016	314	14-0150	220	14-1501	504
11-6520	24	11-8184	28	12-3110	96	13-2030	292	14-0151	220	14-1502	504
11-6521	24	11-8186	28	12-3115	96, 576	13-2031	292	14-0153	220	14-1503	504
11-6522	24	11-8190	16	12-3117	96, 576	13-2032	292	14-0154	220	14-1504	504
11-6523	24	11-8192	16	13-0430	78	13-2033	292	14-0155	220	14-1505	504
11-6524	24	11-8194	16	13-0434	82	13-3000	86	14-0160	502	14-1506	504
11-6525	24	11-8196	16	13-0436	82	13-3001	86	14-0200	220	14-1507	504
11-6530	26	11-8197	16	13-0438	82	13-3002	86	14-0410	516	14-1508	504
11-6531	26	11-8198	16	13-0441	78, 566	13-3030	88	14-0420	516	14-1509	504
11-6532	26	11-8200	128	13-0442	78	13-3200	86	14-0522	516	14-1510	504
11-6533	26	11-8204	16	13-0445	80	13-3205	86	14-0523	516	14-1511	504
11-6534	26	11-8205	16	13-0446	80	13-3207	86	14-0524	516	14-1600	512
11-6535	26	11-8206	14, 16	13-0447	80	13-3760	82	14-0525	516	14-1601	512
11-6540	26	11-8207	14	13-0448	80	13-3765	82	14-0526	516	14-1602	512
11-6541	26	11-8210	128	13-0449	80	13-3766	82	14-0527	510	14-1603	512
11-6542	26	11-8211	128	13-0460	82	13-3771	82	14-0600	508	14-1607	514
11-6543	26	11-8212	128	13-0510	84, 86	13-3800	82	14-0601	508	14-1609	514
11-6544	26	11-8220	128	13-0511	84	13-3805	570	14-0602	508	14-1610	514
11-6545	26	11-8230	128	13-0512	84	13-4000	314	14-0603	508	14-1620	514
11-6600	32	11-8235	128	13-0515	86	13-4100	316	14-0604	508	14-1621	514
11-6601	32	11-8240	16	13-0516	84	13-4200	316	14-0605	508	14-1622	514
11-6602	32	11-8242	16	13-0517	84	13-4300	316	14-0606	508	14-1623	514
11-6603	32	11-8244	16	13-0530	78	13-8122	316	14-0607	508	14-1624	514
11-6620	28	11-8246	16	13-1000	312	13-8123	314	14-0751	510	14-1625	514
11-7100	34	11-8278	14, 456	13-1698	296	14-0008	506	14-0753	510	14-1626	514
11-7101	34	11-8279	14, 456	13-1699	296	14-0009	506	14-0755	514	14-1628	502
11-7102	134	11-8280	14, 456	13-1699	296	14-0012	508	14-0756	512	14-1630	512
11-8040	12	11-8281	14, 456	13-1701	314	14-0013	508	14-0758	512	14-1631	512
11-8041	12	12-0451	36	13-1708	296	14-0014	508	14-0759	512	14-1632	512
11-8042	12	12-2030	246	13-1709	314	14-0015	508	14-0760	512	14-1659	510
11-8043	12	12-2050	36	13-1719	314	14-0016	508	14-0761	512	14-1660	184, 512
11-8044	12	12-2051	38	13-1720	314	14-0017	508	14-0765	514	14-1661	184, 512

14-1662	184, 512	15-0520	192	16-2602	106	16-5992	100	17-0746	402, 478	17-3454	8
14-1663	184, 512	15-0521	192	16-2603	106	16-5993	100	17-0747	402, 478	17-3455	8
14-1664	184, 512	15-0522	192	16-2604	106	16-5994	100	17-0749	454	17-3456	8
14-1665	184, 512	15-0524	192	16-2605	106	16-5995	100	17-0750	454	17-3458	8
14-1667	510	15-0525	192	16-2606	106	16-5996	100	17-0751	454	17-3459	8
14-1790	184, 514	15-0526	146	16-2607	106	16-5997	100	17-0752	454	17-3519	456
14-1795	184, 514	15-0530	192	16-2701	106	16-5998	100	17-0760	460	17-3520	456
14-1840	516	15-0531	192	16-3100	106	16-5999	100	17-0762	460	17-3559	456
14-1845	516	15-0580	200	16-3111	106	16-6000	100	17-0763	460	17-3560	456
14-1850	516	15-1000	194	16-3112	106	16-6001	100	17-0764	460	17-3599	456
14-1855	516	15-1005	194	16-3980	104	16-6002	100	17-0765	460	17-3600	456
14-2010	516	15-1105	194	16-3981	104	16-6003	100	17-0770	460	17-3639	456
14-2011	516	15-1106	194	16-3982	104	16-6004	100	17-0775	460	17-3640	456
14-2030	516	15-1109	194	16-3983	104	16-6006	100	17-0776	460	17-3659	456
14-2032	516	15-1110	194	16-3984	104	16-6007	100	17-0800	460	17-3660	456
14-2040	516	15-1111	192	16-3985	104	16-6008	100	17-0801	460	17-3679	456
14-2050	514, 516	15-1112	194	16-3986	104	16-6009	100	17-0802	460	17-3680	456
14-2055	516	15-1116	194	16-3987	104	16-6010	100	17-0803	460	17-3681	456
14-2350	514	15-2006	194	16-3988	104	16-6011	98	17-0820	460	17-3711	456
14-2865	164	15-2008	194	16-3989	104	16-6012	98	17-0846	402	17-3720	456
14-3120	520	15-2058	70	16-3990	104	16-6013	98	17-0846	478	17-3769	456
14-3125	520	15-2059	70	16-3991	104	16-6014	98	17-0905	454	17-3770	456
14-4492	228, 276	15-2060	70	16-3992	104	16-6016	98	17-1000	460	17-4499	456
14-4493	228, 276	15-2061	70	16-4000	104	16-6017	98	17-1020	454	17-4500	456
14-4494	228, 276	15-2062	70	16-4001	104	16-6018	98	17-1105	456	17-4501	456
14-4495	228, 276	15-2064	70	16-4005	104	16-6019	98	17-1106	456	17-4502	456
14-4496	228, 276	15-2066	70	16-4006	104	16-6021	98	17-1107	456	17-4503	456
14-4497	228, 276	15-2067	70	16-4007	104	16-6022	98	17-1108	456	17-4505	456
14-4498	228	15-2068	70	16-4008	104	16-6023	98	17-1109	456	17-4506	456
14-4999	228, 276	15-2069	70	16-4402	100	16-6024	98	17-1110	454	17-4507	456
14-5000	228, 276	15-2070	70	16-4412	100	16-6026	98	17-1111	454	17-4508	456
14-5001	228, 276	15-2071	70	16-4454	100	16-6027	98	17-1201	456	17-4510	456
14-5002	228, 276	15-2073	564	16-4464	100	16-6028	98	17-1202	456	17-4511	456
14-5004	228, 276	15-2074	564	16-4562	100	16-6029	98	17-1203	456	17-4512	456
14-5005	228, 276	15-2075	564	16-4572	100	16-6052	98	17-1204	456	17-4513	456
14-5010	508	15-5050	264	16-4614	100	16-6053	98	17-1207	456	17-4514	456
14-5015	508	15-5055	264	16-4624	100	16-6054	98	17-1210	450	17-4516	456
14-5020	508	15-5060	264	16-5965	100	16-6055	98	17-1250	450	17-4517	456
14-5030	516	16-0510	106	16-5966	100	16-6056	98	17-1260	450	17-4518	456
14-5034	516	16-0520	106	16-5967	100	16-6057	98	17-1270	450	17-4839	456
14-5060	184, 514	16-0530	106	16-5968	100	16-6058	98	17-1383	452	17-4890	456
14-5062	184, 514	16-0540	106	16-5969	100	16-6059	98	17-1384	452	17-4900	456
14-5063	184, 514	16-0550	106	16-5970	100	16-6070	98	17-1385	452	17-4902	456
14-5064	184, 514	16-0551	106	16-5971	100	16-6071	98	17-2005	452	17-4904	456
14-5065	184	16-0552	106	16-5972	100	16-6072	98	17-2006	452	17-4906	456
15-0009	192	16-0560	106	16-5973	100	16-7000	100	17-2007	452	17-4908	456
15-0012	192	16-0565	106	16-5974	100	16-7001	100	17-3150	458	17-4910	456
15-0501	192	16-0570	106	16-5975	100	16-7002	100	17-3153	458	17-4912	456
15-0502	192	16-0575	106	16-5976	100	16-7003	100	17-3154	458	17-4914	456
15-0503	192	16-0580	106	16-5977	100	16-7007	100	17-3155	458	17-4916	456
15-0504	192	16-0585	106	16-5978	100	16-7008	100	17-3315	458	17-4918	456
15-0505	192	16-0590	106	16-5979	100	16-7009	100	17-3320	458	17-4920	456
15-0506	192	16-0595	106	16-5980	100	16-7010	100	17-3325	458	17-5000	436
15-0509	192	16-0598	106	16-5981	100	16-7050	102	17-3400	458	17-5011	436
15-0510	192	16-0599	106	16-5982	100	16-7051	102	17-3401	458	17-5013	436
15-0511	192	16-2250	104	16-5983	100	16-7052	102	17-3410	458	17-5025	436
15-0512	192	16-2255	104	16-5984	100	16-7053	102	17-3413	458	17-5026	436
15-0513	192	16-2256	104	16-5985	100	16-7054	102	17-3414	458	17-5027	436
15-0514	192	16-2257	104	16-5986	100	16-7055	102	17-3448	8	17-5028	436
15-0515	192	16-2597	104	16-5987	100	16-7056	102	17-3449	8	17-5029	436
15-0516	192	16-2598	106	16-5988	100	16-7530	100	17-3450	8	17-5030	436
15-0517	192	16-2599	106	16-5989	100	16-7535	100	17-3451	8	17-5533	450
15-0518	192	16-2600	106	16-5990	100	16-7540	100	17-3452	8	17-5544	450
15-0519	192	16-2601	106	16-5991	100	17-0745	402, 478	17-3453	8	17-5545	450

Series Index

17-5546	450	17-7258	450	18-1725	120	18-2078	124	18-4012	124	18-5019	122, 124
17-5560	450	17-7510	452	18-1730	120	18-2079	124	18-4014	124	18-5020	122
17-5565	450	17-7513	452	18-1735	120	18-2080	124	18-4015	124	18-5021	122
17-5566	450	17-7515	452	18-1740	120	18-2160	124	18-4016	124	18-5022	122, 124
17-5603	450	17-7516	452	18-1750	120	18-2161	124	18-4018	124	18-5023	122
17-5604	450	17-7517	452	18-1760	120	18-2162	124	18-4021	124	18-5024	122, 124
17-5605	450	17-7519	452	18-1770	120	18-2163	124	18-4023	124	18-5025	122
17-5606	450	17-7610	452	18-1780	120	18-2164	124	18-4025	124	18-5026	122
17-5607	450	17-7719	452	18-1790	120	18-2165	124	18-4027	124	18-5027	122
17-5608	450	17-7722	452	18-1810	120	18-2166	124	18-4029	124	18-5028	122
17-5609	450	17-7726	452	18-1811	120	18-2167	124	18-4031	124	18-5029	122
17-5610	450	17-8700	458	18-1812	120	18-2168	124	18-4050	122	18-5031	122
17-5611	450	17-8710	458	18-1813	120	18-2169	124	18-4051	122	18-5033	122
17-5612	450	17-8720	458	18-1814	120	18-2170	124	18-4052	122	18-5035	122, 124
17-5713	452	17-8732	458	18-1815	120	18-2171	124	18-4053	122	18-5037	122
17-5714	452	17-8734	458	18-1816	120	18-2172	124	18-4054	122	18-5040	122, 124
17-5715	452	17-9001	458	18-1817	120	18-2173	124	18-4055	122	18-5042	122, 124
17-6150	456	17-9002	458	18-1818	120	18-2174	124	18-4056	122	18-5045	122
17-6151	456	17-9003	458	18-1819	120	18-2174	124	18-4057	122	18-5047	122, 124
17-6152	456	17-9004	458	18-1821	120	18-2592	122	18-4058	122	18-5050	122
17-6153	456	17-9460	436	18-1822	120	18-2593	122	18-4059	122	18-5052	122
17-6154	456	17-9470	436	18-1823	120	18-2594	122	18-4060	122	18-5057	122
17-6156	456	17-9480	436	18-1824	120	18-2595	122	18-4061	122	18-5089	128
17-6157	456	17-9490	436	18-1825	120	18-2596	122	18-4062	122	18-5337	122
17-6235	452	17-9550	458	18-1826	120	18-2597	122	18-4063	122	18-5338	122, 124
17-6243	452	17-9552	458	18-1827	120	18-2598	122	18-4064	122	18-5339	122
17-6245	452	17-9560	436	18-1829	120	18-2599	122	18-4065	122	18-5340	122, 124
17-6255	452	17-9562	436	18-1831	120	18-2600	122	18-4066	122	18-5341	122
17-6256	452	17-9570	436	18-1833	120	18-2601	122	18-4067	122	18-5342	122, 124
17-6257	452	17-9580	436	18-1835	120	18-2602	122	18-4068	122	18-5343	122, 124
17-6265	452	17-9590	436	18-1837	120	18-2603	122	18-4069	122	18-5344	122
17-6266	452	18-0500	90	18-1840	120	18-2604	122	18-4070	122	18-5345	122, 124
17-6430	452	18-0502	90	18-1842	120	18-2605	122	18-4075	122	18-5346	122
17-6431	452	18-0504	132	18-1845	120	18-2606	122	18-4110	120	18-5347	122
17-6432	452	18-0505	132	18-1847	120	18-2607	122	18-4111	120	18-5348	122, 124
17-6433	452	18-0506	132	18-1850	120	18-2608	122	18-4112	120	18-5349	122, 124
17-7100	454	18-0507	132	18-1855	120	18-2609	122	18-4113	120	18-5351	122, 124
17-7101	454	18-0509	132	18-1860	120	18-2611	122	18-4114	120	19-2311	108
17-7102	454	18-0510	90	18-1865	120	18-3010	124	18-4115	120	19-2313	108
17-7103	454	18-0515	90	18-1870	120	18-3012	124	18-4116	120	19-2315	108
17-7104	454	18-0516	90	18-1875	120	18-3014	124	18-4117	120	19-2317	108
17-7105	454	18-0517	90	18-1880	120	18-3015	124	18-4118	120	19-2319	108
17-7106	454	18-0518	90	18-1885	120	18-3016	124	18-4119	120	19-2321	108
17-7107	454	18-0519	90	18-1886	120	18-3018	124	18-4120	120	19-2323	108
17-7160	452	18-0520	90, 246	18-1894	122, 124	18-3021	124	18-4121	120	19-2325	108
17-7162	452	18-0521	90, 246	18-1895	122, 124	18-3023	124	18-4122	120	19-2327	108
17-7163	452	18-0522	90, 246	18-1896	122, 124	18-3380	122	18-4123	120	19-2329	108
17-7164	452	18-0525	90	18-1897	122, 124	18-3390	122	18-4124	120	19-2331	108
17-7165	452	18-0526	90	18-1898	122, 124	18-3400	122	18-4125	120	19-2332	108
17-7166	452	18-0530	90	18-1899	122, 124	18-3410	122	18-4126	120	19-2335	108
17-7170	452	18-0531	90	18-1960	122, 124	18-3420	122	18-4127	120	19-2340	108
17-7175	452	18-0532	90	18-1961	122, 124	18-3430	122	18-4128	120	19-2345	108
17-7200	450	18-0533	90	18-1962	122, 124	18-3460	122	18-5001	120	19-2350	108
17-7203	450	18-0535	90	18-1963	122, 124	18-3480	122	18-5005	120	19-2352	108
17-7224	450	18-0536	90	18-1964	122, 124	18-3500	122	18-5006	120	19-2356	108
17-7227	450	18-0537	90	18-1965	122, 124	18-3520	122	18-5009	122, 124	19-2363	108
17-7245	452	18-0538	90	18-2070	124	18-3540	122	18-5010	122, 124	19-2372	108
17-7250	450	18-0539	90	18-2071	124	18-3560	122	18-5012	122, 124	19-2380	108
17-7251	450	18-0540	90	18-2072	124	18-3570	122	18-5013	122	19-2396	108
17-7252	450	18-0541	90	18-2073	124	18-3580	122	18-5014	122	19-2397	108
17-7253	450	18-0542	90	18-2074	124	18-3610	122	18-5015	122	19-2717	108
17-7254	450	18-0543	90	18-2075	124	18-3611	122	18-5016	122	19-2723	108
17-7255	450	18-0545	90	18-2076	124	18-4009	124	18-5017	122	19-2733	108
17-7257	450	18-1530	124	18-2077	124	18-4010	124	18-5018	122	19-2747	108

19-2763	108	20-1201	130	21-0231	156	21-0430	156	21-0540	158	21-0896	162
19-2780	108	20-1202	130	21-0232	156	21-0431	156	21-0541	158, 552	21-0900	162
19-2863	108	20-1203	130	21-0233	156	21-0432	156	21-0542	158	21-0955	158
19-2880	108	20-1204	130	21-0234	156	21-0433	156	21-0544	160	21-0956	158
19-2881	108	20-1205	126	21-0235	156	21-0434	156	21-0545	160	21-0957	158
19-3152	108	20-1206	126	21-0238	156	21-0435	156	21-0546	160	21-0958	158
19-3160	108	20-1207	126	21-0239	156	21-0440	152	21-0547	160	21-0960	130
19-3185	108	20-1208	126	21-0240	176	21-0441	152	21-0548	158	21-1000	160
19-3220	118, 120	20-1209	126	21-0245	156	21-0442	152	21-0620	150	21-1010	160
19-3860	108	20-1210	126	21-0246	156	21-0443	152	21-0621	150	21-1100	160
19-5000	128	20-1211	126	21-0247	156	21-0444	152	21-0622	150	21-1120	160
19-5001	128	20-2820	126	21-0248	156	21-0445	152	21-0623	150	21-1125	160
19-5002	128	20-2821	126	21-0249	156	21-0446	152	21-0624	150	21-1127	160
19-5006	128	20-2822	126	21-0250	160	21-0447	152	21-0625	150	21-1128	162, 284
19-5008	128	20-2823	126	21-0255	160	21-0448	152	21-0626	150	21-1140	160
19-5009	128	20-2920	126	21-0256	160	21-0449	152	21-0627	150	21-1150	160
19-5010	128	20-2922	126	21-0257	156	21-0452	6	21-0628	150	21-1200	28
19-5014	128	20-2924	126	21-0258	156	21-0453	6	21-0630	150	21-1201	28
19-5015	128	20-2930	126	21-0260	152	21-0455	154	21-0631	150	21-1202	28
19-5017	128	20-2932	126	21-0261	152	21-0456	154	21-0632	150	21-1203	28
19-5020	128	20-2934	126	21-0262	152	21-0460	176	21-0633	150	21-1204	28
19-5021	128	21-0003	6	21-0263	152	21-0465	278	21-0634	150	21-1205	28
19-5023	128	21-0011	162	21-0264	152	21-0470	154	21-0640	150	21-1206	28
19-5026	128	21-0016	174	21-0265	152	21-0474	154	21-0641	150	21-1207	28
19-5027	128	21-0022	162	21-0266	156	21-0476	154	21-0642	150	21-1208	28
19-5028	128	21-0025	162, 284	21-0267	156	21-0478	154	21-0643	150	21-1209	28
19-5029	128	21-0052	162	21-0268	156	21-0480	154	21-0650	150	21-1210	28
19-5030	128	21-0053	162	21-0269	158	21-0482	154	21-0651	150	21-1211	28
19-5031	128	21-0080	162	21-0275	158	21-0484	154	21-0652	150	21-1305	176
19-6000	128	21-0081	162	21-0276	158, 548	21-0486	154	21-0653	150	21-1306	176
19-6001	128	21-0082	162	21-0277	158	21-0488	154	21-0660	150	21-1307	176
19-6002	128	21-0083	162	21-0278	158	21-0489	154	21-0661	150	21-1308	176
19-6003	128	21-0084	162	21-0279	158	21-0490	154	21-0662	150	21-1330	176
19-6004	128	21-0087	162	21-0308	148	21-0491	278	21-0663	150	21-1331	176
19-6005	128	21-0160	164	21-0309	148	21-0492	278	21-0664	150	21-1332	176
19-6010	128	21-0162	164	21-0320	148	21-0493	278	21-0670	150	21-1338	176
19-6011	128	21-0180	164	21-0321	148	21-0494	278	21-0671	150	21-1339	176
19-6012	128	21-0181	164	21-0322	148	21-0495	154	21-0672	150	21-1340	148
19-6013	128	21-0183	164	21-0323	148	21-0496	154, 548	21-0673	150	21-1341	148
19-9250	130	21-0184	164	21-0324	152	21-0498	6	21-0674	150	21-1342	148
19-9252	130	21-0186	164	21-0325	152	21-0499	278	21-0680	150	21-1345	148
19-9260	132	21-0187	164	21-0326	152	21-0501	278	21-0681	150	21-1346	148
19-9270	130	21-0188	164	21-0327	152	21-0508	154	21-0682	150	21-1347	148
19-9272	130	21-0189	164	21-0328	152	21-0519	156	21-0683	150	21-1350	148
19-9273	130	21-0207	148	21-0329	152	21-0520	156	21-0684	150	21-1351	148
19-9275	132	21-0208	148	21-0382	152	21-0521	156	21-0710	152	21-1352	148
19-9276	132	21-0209	148	21-0383	152	21-0522	156	21-0711	152	21-1355	148
19-9277	132	21-0210	164	21-0390	158	21-0523	156	21-0712	152	21-1356	148
19-9280	132	21-0215	156	21-0392	152	21-0524	156	21-0713	152	21-1357	148
20-1040	122, 124	21-0216	156	21-0393	152	21-0525	156	21-0714	152	21-1358	148
20-1041	122, 124	21-0217	156	21-0394	152	21-0526	156	21-0715	152	21-1359	148
20-1042	122, 124	21-0218	156	21-0395	176	21-0527	156	21-0716	152	21-1360	148
20-1043	122, 124	21-0219	156	21-0396	176	21-0528	156	21-0717	152	21-1361	148
20-1044	122, 124	21-0220	156	21-0397	176	21-0529	156	21-0718	152	21-1362	148
20-1045	122, 124	21-0221	156	21-0400	174	21-0530	156	21-0719	152	21-1363	148
20-1046	122, 124	21-0222	156	21-0401	174	21-0531	156	21-0720	152	21-1364	148
20-1047	122, 124	21-0223	156	21-0402	174	21-0532	156	21-0721	152	21-1365	148
20-1048	122, 124	21-0224	156	21-0403	174	21-0533	156	21-0722	152	21-1366	148
20-1049	122, 124	21-0225	156	21-0410	174	21-0534	156	21-0723	152	21-1367	148
20-1050	122, 124	21-0226	156	21-0420	176	21-0535	156	21-0724	152	21-1368	148
20-1051	122, 124	21-0227	156	21-0421	176	21-0536	156	21-0725	152	21-1369	148
20-1052	122, 124	21-0228	156	21-0422	176	21-0537	156	21-0726	152	21-1370	148
20-1053	122, 124	21-0229	156	21-0427	176	21-0538	156	21-0727	152	21-1371	148
20-1200	126	21-0230	156	21-0429	176	21-0539	156	21-0740	108	21-1372	148

Series Index

21-1383	176	21-7005	178	21-9001	150	22-1051	144	22-4727	14, 178	22-5941	172
21-1411	154	21-7006	178	21-9010	182	22-1052	144	22-4729	178	22-5950	172
21-1412	154	21-7007	178	21-9050	146	22-1053	144	22-4731	180	22-6006	170
21-1413	154	21-7008	178	21-9099	148	22-1055	144	22-4738	180	22-6007	170
21-1414	154	21-7009	178	21-9101	148	22-1056	144	22-4739	180	22-6008	170
21-1415	154	21-7010	178	21-9102	148	22-1057	144	22-4740	180	22-6009	170
21-1416	154	21-7011	178	21-9103	148	22-1060	144	22-4750	180	22-7403	174
21-1417	154	21-7012	178	21-9104	148	22-1061	144	22-4761	182	22-7424	174
21-1418	154	21-7013	178	21-9114	148	22-1062	144	22-4771	180	22-7425	174
21-1419	154	21-7014	178	21-9115	148	22-1070	144	22-4772	180	22-7426	174
21-1420	154	21-7015	178	21-9116	148	22-1071	144	22-4773	180	22-7427	174
21-1421	154	21-7040	188	21-9117	148	22-1072	144	22-4776	180	22-7428	174
21-1422	154	21-7043	188	21-9118	148	22-1100	146	22-4778	180	22-7431	174
21-1423	154	21-7044	188	21-9120	148	22-1101	144	22-5506	170	22-7432	174
21-1424	154	21-7045	188	21-9121	148	22-1102	144	22-5507	170	22-7435	168
21-1425	154	21-7046	188	21-9122	148	22-1110	146	22-5509	170	22-7436	168
21-1426	154	21-7047	182	21-9137	150	22-1112	146	22-5600	170	22-7437	174
21-1427	154	21-7048	182	21-9138	150	22-1113	146	22-5620	170	22-7438	174
21-1778	182	21-7049	182	21-9139	150	22-1123	144	22-5621	170	22-7439	174
21-2002	162	21-7049	188	21-9140	150	22-1124	144	22-5622	170	22-7440	174
21-2003	162	21-7050	186	21-9141	150	22-1150	142	22-5700	170	22-7500	478
21-2510	160	21-7051	186	21-9142	150	22-1152	142	22-5701	170	22-7502	478
21-2520	160	21-7052	186	21-9143	150	22-1153	142	22-5702	170	22-7503	478
21-2600	162	21-7053	188	21-9144	150	22-1170	142	22-5703	170	22-7506	478
21-2601	162	21-7054	188	21-9145	150	22-1180	142	22-5800	170	22-7508	402, 478
21-2602	162	21-7055	188	21-9146	150	22-1185	142	22-5811	168	22-7511	478
21-2603	68	21-7056	188	21-9147	150	22-1200	142	22-5811	188	22-7900	178
21-2604	162	21-7057	182	21-9148	150	22-1201	142	22-5840	168	22-7910	142, 184
21-2800	160	21-7058	182	21-9149	150	22-1300	140	22-5844	168	22-7911	142, 184
21-2812	160	21-7059	182, 188	21-9150	150	22-1301	140	22-5845	168	22-7912	142, 184
21-2817	160	21-7060	182, 188	21-9151	150	22-1302	140	22-5849	168	22-7913	184
21-2822	160	21-7400	182	21-9152	150	22-1303	140	22-5850	166	22-7913KIT	184
21-2835	158	21-7401	182	21-9153	150	22-1304	140	22-5855	166	22-7914	184
21-2880	160	21-7602	182	21-9154	150	22-1600	146	22-5856	166	22-7914KIT	184
21-2895	158	21-7603	182	21-9159	150	22-2110	146	22-5860	166	22-7930	184
21-4995	142	21-7604	182	21-9160	152	22-2111	146	22-5865	166	22-7931	184
21-4996	142	21-7605	182	21-9161	150	22-2112	146	22-5869	166	22-7932	184
21-4999	142	21-7605	188	21-9162	152	22-2160	136	22-5870	168	22-7933	184
21-5000	142	21-7606	182	21-9163	152	22-2170	138	22-5871	168	22-7937	184
21-5001	142	21-7607	182	21-9165	152	22-2180	138	22-5880	166	22-7938	184
21-5002	142	21-7608	182	21-9166	152	22-2190	138	22-5885	166	22-7942	184
21-5003	142	21-7609	182	21-9167	150	22-2200	136	22-5889	168	22-7943	184
21-5004	142	21-7700	182	22-0085	164	22-3600	140	22-5896	166	22-7944	184
21-5005	142	21-7701	182	22-0088	164	22-3602	140	22-5900	166	22-7946	184
21-5006	142	21-7705	182	22-0089	164	22-3603	140	22-5901	166	22-8000	184
21-5007	142	21-7710	182	22-0090	164	22-3604	140	22-5902	166	22-8150	184
21-6550	160	21-7720	182	22-0091	164	22-3700	186	22-5903	166	22-8152	184
21-6925	178	21-7721	182	22-0092	164	22-3702	186	22-5904	166	22-8700	186
21-6930	178	21-7827	178	22-0093	164	22-3703	186	22-5905	166	22-8701	186
21-6935	178	21-7828	178	22-0094	164	22-4610	186	22-5906	166	22-8702	186
21-6940	178	21-7829	178	22-0095	164	22-4612	186	22-5907	166	22-8710	186
21-6945	178	21-7830	178	22-0096	164	22-4620	140, 186	22-5908	166	22-8711	186
21-6950	178	21-7831	178	22-0097	164	22-4624	186	22-5915	166	22-8712	186
21-6955	178	21-7832	178	22-0133	164	22-4631	186	22-5916	166	22-8770	186
21-6960	178	21-7833	178	22-0510	186	22-4634	186	22-5922	170	22-8771	186
21-6965	178	21-7834	178	22-1000	144	22-4700	186	22-5923	170	22-8772	186
21-6966	178	21-7835	178	22-1005	144	22-4701	186	22-5924	170	22-9001	146
21-6967	178	21-7836	178	22-1008	144	22-4702	186	22-5925	170	22-9002	146
21-6970	178	21-7970	178	22-1028	146	22-4703	186	22-5926	172	23-0039	188
21-7000	178	21-7975	178	22-1029	146	22-4704	186	22-5927	172	23-0043	188
21-7001	178	21-7976	178	22-1035	146	22-4719	178	22-5928	172	23-0043	478
21-7002	178	21-7976	178	22-1038	146	22-4720	178	22-5929	172	23-0044	188
21-7003	178	21-7980	178	22-1045	144	22-4722	178	22-5930	172	23-0047	188
21-7005	142	21-9000	150	22-1047	144	22-4725	178	22-5940	172	23-0048	188

23-0049	190	23-6020	192, 208	26-2010	242	26-4009	226	26-4129	242	28-0540	210
23-0050	190	23-6021	192, 208	26-2601	302	26-4011	226	26-4130	242	28-0550	210
23-0051	190	23-6022	208	26-2602	302	26-4013	228	26-4131	242	28-0551	210
23-0052	190	23-6023	208	26-2603	302	26-4014	248	26-4133	242	28-0552	210
23-0053	190	23-6200	196	26-2604	302	26-4015	248	26-4134	242	28-0554	210
23-0054	190	23-6204	204	26-3660	244	26-4016	248	26-4135	238, 250	28-0555	210
23-0055	188	23-6205	204	26-3750	224	26-4017	248	26-4136	238	28-0557	210
23-0057	190	23-6206	204	26-3760	224	26-4018	248	26-4137	238, 250	28-0558	210
23-0058	190	23-6208	200	26-3762	224	26-4019	248	26-4138	250	28-0559	210
23-0059	190	23-6209	196	26-3770	224	26-4026	226	26-4139	242	28-0560	210
23-0061	188	23-6210	196	26-3780	224	26-4030	228	26-4140	238	28-0561	210
23-0062	188	23-6500	200	26-3781	224	26-4035	228	26-4144	98	28-0562	210
23-0065	206	23-6501	198, 200	26-3840	220	26-4036	226	26-4145	518	28-0563	210
23-0073	190	23-6502	198, 200	26-3850	224	26-4036	226	26-4146	518	28-0564	210
23-0074	190	23-6610	200	26-3854	224	26-4037	226	26-4147	244	28-0565	210
23-0075	190	23-6611	200	26-3855	224	26-4038	226	26-4148	86	28-0566	210
23-0076	190	23-6612	200	26-3856	224	26-4039	218	26-4149	244	28-0567	210
23-0077	190	24-1006	134	26-3857	224	26-4040	248	26-4150	472	28-0568	210
23-0078	190	24-1008	134	26-3858	224	26-4041	248	26-4151	244	28-0569	210
23-0080	190	25-0440	380	26-3859	224	26-4042	248	26-4152	244	28-0570	210
23-0900	578	25-0444	380	26-3870	220	26-4043	248	26-4154	244	28-0571	210
23-1000	196	25-0445	380	26-3871	220	26-4050	228	26-4155	98	28-0572	210
23-1010	196	25-0446	428	26-3872	220	26-4055	276	26-4156	242	28-0573	210
23-1012	196	25-0449	386	26-3873	220	26-4056	276	26-4157	242	28-0574	210
23-1015	196	25-0550	380	26-3874	220	26-4057	276	26-4158	86	28-0575	210
23-1020	196	25-0565	384	26-3875	220	26-4059	230	26-4159	86	28-0576	210
23-1030	204	25-0566	384	26-3879	216	26-4073	228	26-4160	248	28-0577	210
23-1032	204	25-0570	380	26-3881	220	26-4076	230	26-4161	248	28-0578	210
23-1034	204	25-0571	380	26-3883	220	26-4079	230	26-4162	242	28-0579	210
23-2000	204	25-0572	96	26-3884	220	26-4080	228	26-4163	242	28-0580	210
23-2400	460	25-0573	386	26-3885	220	26-4081	230	26-4165	244	28-0601	210
23-2401	460	25-0574	378	26-3887	220	26-4082	228	26-4166	244	28-0602	210
23-2402	460	25-0575	384	26-3894	220	26-4083	228	26-4167	242, 500	28-0603	210
23-2403	460	25-0580	380	26-3900	224	26-4084	230	26-4168	94, 246	28-0604	210
23-2404	460	25-0581	380	26-3909	224	26-4085	230	26-4169	94, 246	28-0605	210
23-2500	460, 500	25-0600	386	26-3910	224	26-4086	230	26-4180	250	28-0606	210
23-2501	460	25-0602	386	26-3911	224	26-4089	228	26-4181	250	28-0607	210
23-5550	564	25-1228	384	26-3912	224	26-4094	230	26-4182	86	28-0608	210
23-5710	198	25-1229	384	26-3914	224	26-4098	230	26-4185	230	28-0609	210
23-5712	198	25-1230	384	26-3915	224	26-4099	86	26-4194	230	28-0610	210
23-5850	198	25-1233	384	26-3917	224	26-4100	86	26-4196	228	28-0611	210
23-5851	198	25-1234	384	26-3919	222	26-4101	86	26-4197	86, 484	28-0612	210
23-5854	198	25-1235	384	26-3919S	222	26-4102	86	26-4205	94, 244	28-0613	210
23-5858	198	25-1236	384	26-3920	222	26-4103	86	26-4215	94, 244	28-0614	210
23-5859	198	25-1237	384	26-3921	222	26-4105	242	26-4216	94, 244	28-0615	210
23-5872	200	25-1240	386	26-3922	222	26-4106	242	26-5000	244	28-0616	210
23-5874	200	25-1241	386	26-3923	222	26-4107	86, 242	26-5001	244	28-0617	210
23-5900	204	25-1341	386	26-3924	222	26-4108	242	26-5118	518	28-0618	210
23-5901	200	25-1347	90	26-3930	226	26-4112	246	26-5119	518	28-0619	210
23-5904	200	25-1350	380	26-3985	236	26-4113	244	26-5400	244	28-0620	210
23-5905	204	25-1352	380	26-3986	240	26-4114	86	26-6000	92	28-0621	210
23-5915	196	25-1353	380	26-3989	248	26-4115	518	26-6001	92	28-0622	210
23-5920	196	25-1354	380	26-3990	248	26-4116	518	26-6002	92	28-0623	210
23-5928	196	25-1370	484	26-3991	248	26-4117	518	26-6003	92	28-0624	210
23-5929	196	25-2001	380	26-3992	248	26-4118	518	26-6006	94	28-0625	210
23-5931	196	25-2002	378	26-3993	248	26-4119	518	26-6008	298	28-0626	210
23-5936	196	25-2003	378	26-3994	248	26-4120	86	26-6009	38	28-0627	210
23-5938	196	26-1000	108, 244	26-3995	248	26-4121	88	26-6010	38	28-0628	210
23-5940	196	26-1002	244	26-3996	248	26-4122	518	28-0422	376	28-0629	210
23-5942	196	26-1003	216	26-3997	248	26-4123	518	28-0423	376	28-0630	210
23-5950	196	26-1600	244	26-3999	248	26-4124	518	28-0425	376	28-0631	210
23-6011	208	26-1700	230	26-4000	248	26-4125	86	28-0440	376	28-0681	210, 212
23-6012	208	26-2000	242	26-4001	248	26-4126	86	28-0460	376	28-0682	210
23-6015	192, 208	26-2004	242	26-4002	248	26-4128	242	28-0472	376	28-0683	212

Series Index

28-0684	212	28-3010	214	29-0101	480	29-4708	322	29-6010	318	29-7503	326
28-0686	216	28-3011	214	29-0102	480	29-4709	322	29-6012	318	29-7504	326
28-0688	210, 212	28-3012	214	29-0103	480	29-4710	322	29-6013	318	29-7505	326
28-0700	218	28-3013	214	29-0200	302	29-4711	322	29-6014	318	29-7600	328
28-0705	218	28-3014	214	29-1300	320	29-4714	322	29-6015	318	29-7601	328
28-0710	218	28-3015	214	29-1301	320	29-4715	322	29-6016	322	29-7602	328
28-0711	218	28-4000	210, 212	29-1302	320	29-4720	322	29-6017	322	29-7603	328
28-0712	218	28-5040	210	29-1303	320	29-4721	322	29-6018	322	29-7605	328
28-0713	218	28-5870	214	29-1304	320	29-4725	328	29-6020	318	29-7700	328
28-0714	218	28-5871	214	29-1310	324	29-4726	328	29-6021	318	29-7701	328
28-0715	218	28-5872	214	29-1311	324	29-4727	328	29-6022	318	29-7702	328
28-0716	218	28-5873	214	29-1312	324	29-4728	328	29-6023	318	29-7703	328
28-0717	218	28-5874	214	29-1313	324	29-4730	324	29-6024	318	29-7704	328
28-0718	218	28-5875	214	29-1400	326	29-4731	322	29-6025	322	29-7705	328
28-0719	218	28-5876	214	29-1401	326	29-4732	322	29-6026	322	31-0271	252
28-0720	218	28-5877	214	29-1402	326	29-4738	324	29-6027	322	31-0280	252
28-0721	218	28-5878	214	29-1403	326	29-4739	324	29-6028	322	31-0291	252
28-0722	218	28-5879	214	29-1404	326	29-4740	294	29-6030	318	31-0302	252
28-0723	218	28-5880	214	29-1405	326	29-4741	294	29-6031	318	31-0314	252
28-0724	218	28-5881	214	29-1406	326	29-4742	296	29-6032	318	31-0590	254
28-0725	218	28-5882	214	29-1407	326	29-4743	296	29-6035	318	31-0602	254
28-0730	218	28-6001	18	29-1408	326	29-4744	294	29-6036	318	31-0614	254
28-0731	218	28-6005	18	29-1499	302	29-4745	296	29-6037	318	31-0680	254
28-0732	218	28-6006	18	29-1501	292	29-4746	296	29-6040	320	31-0690	254
28-0733	218	29-0003	476	29-1502	292	29-4749	294	29-6041	320	31-0702	254
28-0734	218	29-0004	476	29-1503	292	29-4755	294	29-6042	320	31-0714	254
28-0736	218	29-0005	476	29-1504	292	29-4758	302	29-6043	320	31-1110	252
28-0737	218	29-0006	476	29-1505	292	29-4759	302	29-6044	320	31-1120	252
28-0738	218	29-0007	476	29-1506	292	29-4763	328	29-6045	320	31-1131	252
28-0739	218	29-0008	476	29-1510	292	29-4764	328	29-6047	318	31-1142	252
28-0740	218	29-0009	474	29-1511	292	29-4769	322	29-6048	318	31-1153	252
28-0741	218	29-0010	474	29-1512	292	29-4776	312	29-6049	318	31-1164	252
28-0751	218	29-0012	474	29-1602	294	29-4777	312	29-6050	320	31-1176	252
28-0752	218	29-0013	474	29-1605	296	29-4778	312	29-6051	320	31-1271	252
28-0753	218	29-0014	474	29-1652	294	29-4779	326	29-6052	320	31-1280	252
28-0754	218	29-0015	474	29-1805	326	29-4780	296	29-6060	318	31-1291	252
28-0755	218	29-0016	474	29-1806	326	29-4781	324	29-6070	318	31-1302	252
28-0757	218	29-0017	476	29-1807	326	29-4782	296	29-6071	318	31-1313	252
28-0758	218	29-0019	476	29-1809	326	29-4783	296	29-6072	318	31-1324	252
28-0759	218	29-0021	476	29-1810	326	29-4787	320	29-6073	318	31-1431	254
28-1000	214	29-0022	476	29-2500	298	29-4788	320	29-6074	318	31-1440	254
28-1991	376	29-0026	476	29-2501	314	29-4790	316	29-6075	318	31-1451	254
28-1992	374	29-0027	476	29-2502	314	29-4791	326	29-6080	314	31-1462	254
28-1993	374	29-0028	476	29-2503	316	29-4792	326	29-6081	314	31-1473	254
28-1994	376	29-0029	476	29-2601	320	29-4793	328	29-6082	314	31-1484	254
28-1996	374	29-0030	474	29-2602	320	29-4797	328	29-6083	314	31-1496	254
28-1997	374	29-0031	476	29-2603	320	29-4798	328	29-6084	314	31-2117	254
28-1998	374	29-0032	474	29-2605	318	29-4799	328	29-6100	322	31-2118	254
28-2002	374	29-0035	478	29-2606	318	29-4800	328	29-6105	324	31-2120	254
28-2003	374	29-0040	474	29-2710	298	29-4801	328	29-6110	324	31-2121	254
28-2004	374	29-0045	476	29-2711	298	29-4802	328	29-6111	324	31-2122	254
28-2005	374	29-0046	476	29-2712	298	29-4803	328	29-6112	324	31-2123	254
28-2006	376	29-0047	476	29-2713	298	29-4811	328	29-6113	324	31-2124	254
28-2007	374	29-0048	476	29-2714	298	29-4812	328	29-6115	324	31-2125	254
28-2008	374	29-0049	476	29-3002	296	29-4840	294	29-6500	322	31-2126	254
28-2009	376	29-0050	474	29-3005	296	29-4841	294	29-6505	298, 320	31-2128	254
28-2040	76	29-0058	474	29-4600	326	29-4842	294	29-6509	322	31-2129	254
28-2041	428	29-0059	474	29-4700	322	29-4848	294	29-6770	318	31-2131	256
28-2042	388	29-0063	474	29-4702	322	29-4855	294	29-6775	318	31-2132	252
28-2043	76	29-0065	474	29-4703	322	29-5610	324	29-7000	320	31-2133	256
28-2114	270, 272	29-0067	474	29-4704	322	29-6000	320	29-7201	322	31-2135	256
28-2115	218	29-0068	474	29-4705	322	29-6002	318	29-7202	322	31-2136	256
28-2116	218	29-0069	474	29-4706	322	29-6003	318	29-7500	326	31-2137	254
28-2118	218	29-0100	480	29-4707	322	29-6005	318	29-7502	326	31-2138	254

31-2139	254	31-5642	258	31-8004	256	34-1012	276	34-2267	268	34-6114	278
31-2140	254	31-5654	258	31-8006	256	34-2000	440	34-2268	270	34-6115	278
31-2141	258	31-5901	260	31-8008	256	34-2001	440	34-2270	268	34-6116	278
31-2142	258	31-5910	260	31-8010	256	34-2002	440	34-2271	268	34-6300	216
31-2143	258	31-5932	260	31-8012	256	34-2008	440	34-2273	268	34-6301	96
31-2430	252	31-5954	260	31-8014	256	34-2010	440	34-2274	268	34-6301	216
31-2440	252	31-5966	260	31-8016	256	34-2012	440	34-2275	268	34-6302	216
31-2451	252	31-5970	258	31-8018	256	34-2013	34, 104, 440	34-2276	268	35-0140	284
31-2462	252	31-5982	258	31-8020	256	34-2014	34, 104, 440	34-2277	268	35-0200	284
31-2473	252	31-5994	258	31-8022	256	34-2015	440	34-2279	266, 268	35-0300	284
31-2484	252	31-6191	260	31-8024	256	34-2016	440	34-2280	268	35-0425	286
31-2496	252	31-6200	260	31-8026	256	34-2100	270	34-2281	268	35-0705	282
31-2870	254	31-6222	260	31-8028	256	34-2100	272	34-2283	268	35-0800	162, 284
31-2880	254	31-6244	260	31-8030	256	34-2103	270	34-2286	266, 268	35-0802	162, 284
31-2891	254	31-6256	260	31-8032	256	34-2110	272	34-2289	268	35-0805	162, 284
31-2902	254	31-6371	260	31-8034	256	34-2113	272	34-2293	266	35-0806	162, 284
31-2913	254	31-6380	260	31-8036	256	34-2114	272	34-2294	266	35-1094	290
31-2924	254	31-6402	260	31-8038	256	34-2115	272	34-2295	268	35-1200	280
31-3710	254	31-6424	260	31-8040	256	34-2130	266, 272	34-2297	268	35-1202	280
31-3720	254	31-6436	260	31-8042	256	34-2131	266, 272	34-2298	272	35-1203	280
31-3731	254	31-6450	258	31-8044	256	34-2132	272	34-2299	270	35-1234	278
31-3742	254	31-6472	258	31-8046	256	34-2135	130, 272	34-2303	270	35-1235	278
31-3754	254	31-6494	258	31-8048	256	34-2138	130, 272	34-2304	270	35-1520	282
31-3802	254	31-6506	258	31-8050	256	34-2139	130, 272	34-2305	440	35-1522	282
31-3803	254	31-6790	262	31-8052	256	34-2156	266, 268	34-2307	266, 268	35-1524	282
31-3804	254	31-6802	262	31-8054	256	34-2157	266, 268	34-2308	268	35-1526	282
31-3840	252	31-6814	262	31-8056	254	34-2158	266, 268	34-2309	268	35-1528	282
31-3850	252	31-6828	262	31-8058	254	34-2159	268	34-2310	270	35-1529	282
31-4581	260	31-6840	264	31-8060	254	34-2190	276	34-2319	268	35-1796	282
31-4590	260	31-6852	264	31-8062	254	34-2207	270	34-2325	268	35-1797	282
31-4612	260	31-7000	260	31-8064	254	34-2208	270	34-2327	268	35-1798	282
31-4634	260	31-7012	260	31-8066	254	34-2209	270	34-2346	268	35-1812	280
31-4646	260	31-7034	260	31-8068	254	34-2210	270	34-2347	268	35-1813	280
31-4660	258	31-7046	260	31-8070	254	34-2211	272	34-2351	268, 272	35-1814	280
31-4682	258	31-7050	260	31-8072	254	34-2212	272	34-2352	272	35-1815	280
31-4704	258	31-7142	260	31-8074	254	34-2213	266, 270	34-2353	272	35-1817	280
31-4900	260	31-7154	260	31-8076	254	34-2214	270	34-2354	270	35-1818	280
31-4912	260	31-7166	260	31-8078	254	34-2215	266, 272	34-2355	270	35-1830	282
31-4924	260	31-7202	260	31-9910	264	34-2216	130, 272	34-2356	270	35-2301	280
31-4936	260	31-7214	260	33-6029	126	34-2217	272	34-2360	270	35-2605	286
31-4940	258	31-7240	260	33-6032	126	34-2218	272	34-2361	270	35-2606	286
31-4952	258	31-7252	260	33-6350	126	34-2219	270	34-2370	272	35-2607	286
31-4964	258	31-7274	260	33-6355	126	34-2220	272	34-2375	266, 270	35-2610	286
31-5051	258	31-7286	260	33-8301	262	34-2224	226	34-2376	270	35-2611	288
31-5060	258	31-7290	260	33-8302	262	34-2229	250	34-2377	270	35-2612	286
31-5082	258	31-7336	262	33-8305	262	34-2231	250	34-2380	274	35-2613	288
31-5104	258	31-7420	260	33-9220	252	34-2232	250	34-2381	274	35-2614	286
31-5116	258	31-7432	260	33-9221	252	34-2233	226, 250	34-2382	274	35-2615	288
31-5120	258	31-7454	260	33-9222	252	34-2234	226, 250	34-2383	274	35-2618	288
31-5132	258	31-7466	260	33-9223	252	34-2240	266	34-2384	274	35-2620	288
31-5144	258	31-7470	260	33-9224	252	34-2241	266	34-2385	274	35-2621	288
31-5241	258	31-7526	260	33-9225	252	34-2242	266	34-2386	274	35-2622	288
31-5250	258	31-7576	262	33-9226	252	34-2243	266	34-2387	274	35-2625	286
31-5272	258	31-7600	262	33-9235	264	34-2250	272	34-2396	274	35-2626	286
31-5294	258	31-7612	262	33-9240	252	34-2251	268	34-2397	274	35-2650	286
31-5306	258	31-7624	262	33-9500	264	34-2254	268	34-2398	274	35-2800	288
31-5310	258	31-7625	262	33-9501	264	34-2255	266	34-2399	274	35-2801	288
31-5332	258	31-7626	262	33-9502	264	34-2257	266	34-2402	270	35-2802	288
31-5354	258	31-7627	262	33-9503	264	34-2259	268	34-2403	276	35-2803	288
31-5580	260	31-7629	262	33-9504	264	34-2260	266, 268	34-3000	278	35-2810	292
31-5592	260	31-7636	262	33-9505	264	34-2261	268	34-3002	278	35-2820	288
31-5614	260	31-7637	262	33-9810	254	34-2262	268	34-6110	268	35-2840	288
31-5626	260	31-8000	256	34-1000	440	34-2263	268	34-6112	268	35-2860	288
31-5630	258	31-8002	256	34-1010	276	34-2266	270	34-6113	278	35-2880	288

Series Index

35-2900	290	36-1556	244	36-2635	234	36-3513	234	36-3607	234	37-1553	304
35-2902	288	36-2540	236	36-2636	234	36-3514	234	36-3608	234	37-1554	304
35-2903	288	36-2541	236	36-2640	236	36-3515	234	36-3609	234	37-1555	304
35-2904	290	36-2542	236	36-2641	236	36-3516	234	36-3610	234	37-1556	274, 306
35-2905	290	36-2543	236	36-2642	236	36-3517	234	36-3611	234	37-1557	274, 306
35-2907	290	36-2545	236	36-2643	236	36-3518	234	36-3612	234	37-1558	274, 306
35-2908	290	36-2546	236	36-2644	236	36-3519	234	36-3613	234	37-1559	304
35-2909	290	36-2547	236	36-2645	236	36-3523	234	36-3614	234	37-1560	274, 304
35-2910	290	36-2548	236	36-2646	236	36-3524	234	36-3615	234	37-1561	274, 304
35-2912	288	36-2549	236	36-2647	236	36-3525	234	36-3619	234	37-2150	310
35-2914	288	36-2550	232	36-2648	236	36-3526	234	36-3620	234	37-2160	310
35-2915	288	36-2551	232	36-2649	236	36-3527	234	36-3621	234	37-2169	308
35-2916	290	36-2552	232	36-2650	236	36-3528	234	36-3622	234	37-2170	308
35-2918	290	36-2553	232	36-2700	232	36-3529	234	36-6500	234	37-2171	308
35-2920	290	36-2554	232	36-2701	232	36-3530	234	36-6501	234	37-2172	308
35-2921	290	36-2555	232	36-2702	232	36-3531	234	36-6502	234	37-2180	310
35-2922	290	36-2556	232	36-2703	232	36-3532	234	36-6510	234	37-3030	310
35-2923	290	36-2557	232	36-2704	232	36-3535	234	36-6511	234	37-5300	308
35-2924	290	36-2558	232	36-2705	232	36-3536	234	36-6512	234	37-5310	308
35-2925	292	36-2559	232	36-2706	232	36-3537	234	36-6513	234	37-5315	308
35-2926	292	36-2560	232	36-2707	232	36-3538	234	36-6514	234	37-5320	310
35-2927	292	36-2561	232	36-2708	232	36-3542	234	36-6520	234	37-5321	310
35-2928	292	36-2562	232	36-2709	232	36-3543	234	36-6521	234	37-5360	308
35-2929	290	36-2563	232	36-2710	232	36-3544	234	36-6522	234	37-5400	308
35-2930	290	36-2564	232	36-2711	232	36-3548	234	36-6530	234	37-5401	308
35-2940	292	36-2565	232	36-2712	232	36-3549	234	36-6531	234	37-5402	304, 306, 308
35-2941	292	36-2566	232	36-2713	232	36-3550	234	36-6532	234	37-5403	306, 308
35-2942	292	36-2567	232	36-2714	232	36-3551	234	36-6533	234	37-5404	306, 308
35-2945	288	36-2570	232	36-2715	232	36-3552	234	36-6534	234	37-5500	308
35-2947	288	36-2571	232	36-2716	232	36-3553	234	36-6540	234	37-5502	308
35-2964	292	36-2572	232	36-2717	232	36-3554	234	36-6541	234	37-5840	308
35-2980	290	36-2573	232	36-2718	232	36-3555	234	36-6542	234	37-5900	308
35-2981	290	36-2574	232	36-2719	232	36-3556	234	36-6550	234	37-5902	308
35-2982	290	36-2580	232	36-2720	232	36-3557	234	36-6551	234	37-7000	310
35-2983	290	36-2581	232	36-2721	232	36-3558	234	36-6560	234	37-7001	310
35-2998	288	36-2582	232	36-2722	232	36-3559	234	36-6570	234	37-7002	310
35-2999	288	36-2585	232	36-2723	232	36-3560	234	36-8000	240	37-7003	310
35-5100	282	36-2590	232	36-2724	232	36-3561	234	36-8630	240	37-7004	310
35-5104	282	36-2591	232	36-2725	232	36-3565	234	36-8800	238	37-7070	310
35-5106	282	36-2592	232	36-2726	232	36-3566	234	36-8800	238	37-7071	310
35-5115	282	36-2595	238	36-2727	232	36-3567	234	36-8801	238	37-7072	310
35-5117	286	36-2596	238	36-2728	232	36-3568	234	36-8840	238	37-7073	310
35-5510	284	36-2597	238	36-2729	232	36-3569	234	36-8840	238	37-7600	442
35-5515	286	36-2600	232	36-2730	232	36-3570	234	37-0363	310	37-7601	442
35-5550	286	36-2601	232	36-2731	232	36-3571	234	37-0364	310	37-7640	92
35-5600	286	36-2602	232	36-2732	232	36-3572	234	37-0365	310	37-7846	264
35-5602	286	36-2603	232	36-2733	232	36-3573	234	37-0366	310	37-7850	264
35-5609	282	36-2604	232	36-2734	232	36-3574	234	37-0367	310	37-7851	264
35-5610	286	36-2605	232	36-2735	232	36-3575	234	37-0409	308	37-7852	264
35-5615	284	36-2606	232	36-2736	232	36-3579	234	37-0410	310	37-7856	264
35-5617	284	36-2607	232	36-2737	232	36-3580	234	37-0411	310	37-8330	264
35-5628	280	36-2609	238	36-2738	232	36-3581	234	37-0412	310	37-8336	264
35-5629	280	36-2610	234	36-2739	232	36-3582	234	37-1202	308	37-8500	238
35-5630	280	36-2611	234	36-2740	232	36-3583	234	37-1220	308	37-8501	238
35-5635	282	36-2612	234	36-2741	232	36-3584	234	37-1230	306	37-8502	238
35-5700	158	36-2613	234	36-3500	234	36-3585	234	37-1231	306	37-8503	238
36-1200	234	36-2614	234	36-3501	234	36-3586	234	37-1240	306	37-8504	238
36-1201	234	36-2620	234	36-3502	234	36-3590	234	37-1241	306	37-8505	238
36-1202	234	36-2621	234	36-3503	234	36-3591	234	37-1250	306	37-8506	238
36-1203	234	36-2622	234	36-3504	234	36-3592	234	37-1255	306	37-8507	238
36-1204	234	36-2623	234	36-3505	234	36-3593	234	37-1256	306	37-8508	238
36-1205	234	36-2624	234	36-3506	234	36-3594	234	37-1550	304	37-8509	238
36-1206	234	36-2630	234	36-3511	234	36-3605	234	37-1551	304	37-8510	238
36-1207	234	36-2631	234	36-3512	234	36-3606	234	37-1552	304	37-8600	238

37-8601	238	38-4003	52	38-4069	52	38-5051	52	38-7006	56	38-7164	62
37-8602	238	38-4004	52	38-4070	52	38-5052	52	38-7007	56	38-7165	62
37-8603	238	38-4005	52	38-4071	52	38-5053	52	38-7010	62	38-7166	62
37-8790	264	38-4006	52	38-4072	52	38-5054	52	38-7011	62	38-7167	62
37-8792	264	38-4007	52	38-4073	52	38-5055	52	38-7012	62	38-7170	62
37-8794	264	38-4008	52	38-4074	52	38-5056	52	38-7013	62	38-7171	62
37-9000	218	38-4009	52	38-4076	52	38-5057	52	38-7014	62	38-7172	62
38-0000	60	38-4010	52	38-4078	52	38-5058	52	38-7015	62	38-7184	60
38-0001	60	38-4011	52	38-4082	52	38-5059	52	38-7016	62	38-7185	60
38-0003	60	38-4012	52	38-4084	52	38-5060	52	38-7017	62	38-7186	60
38-0004	60	38-4013	52	38-4086	52	38-5061	52	38-7050	56	38-7187	60
38-0005	58	38-4014	52	38-4088	52	38-5062	52	38-7052	56	38-7188	54
38-0006	58	38-4015	52	38-4092	52	38-5063	52	38-7060	56	38-7189	54
38-0007	58	38-4016	52	38-4093	52	38-5064	52	38-7062	56	38-7190	58
38-0008	58	38-4017	52	38-4094	52	38-5065	52	38-7070	56	38-7191	54
38-0009	60	38-4018	52	38-4096	52	38-5066	52	38-7071	56	38-7192	54
38-0010	60	38-4019	52	38-4098	52	38-5067	52	38-7085	58	38-7193	54
38-0011	60	38-4020	52	38-4099	54	38-5068	52	38-7086	58	38-7194	54
38-0012	60	38-4021	52	38-5001	52	38-5069	52	38-7087	58	38-7195	54
38-0100	56	38-4022	52	38-5002	52	38-5070	52	38-7088	58	38-7196	54
38-0101	56	38-4023	52	38-5003	52	38-5071	52	38-7090	56	38-7197	54
38-0102	56	38-4024	52	38-5004	52	38-5072	52	38-7091	56	38-7198	54
38-0106	56	38-4025	52	38-5005	52	38-5073	52	38-7092	56	38-7200	64
38-0107	56	38-4026	52	38-5006	52	38-5074	52	38-7093	56	38-7201	64
38-0108	56	38-4027	52	38-5008	52	38-5075	52	38-7096	58	38-7202	64
38-0115	56	38-4028	52	38-5009	52	38-5076	52	38-7097	58	38-7203	64
38-0116	56	38-4029	52	38-5012	52	38-5077	52	38-7098	58	38-7204	64
38-0117	56	38-4030	52	38-5013	52	38-5078	52	38-7099	58	38-7205	64
38-0118	56	38-4031	52	38-5014	52	38-5079	52	38-7100	58	38-7206	64
38-0119	56	38-4032	52	38-5015	52	38-5080	52	38-7101	58	38-7207	64
38-0180	68	38-4033	52	38-5016	52	38-5082	52	38-7104	58	38-7208	64
38-0188	58	38-4034	52	38-5018	52	38-5084	52	38-7105	58	38-7209	64
38-0189	58	38-4035	52	38-5019	52	38-5086	52	38-7108	58	38-7210	64
38-0190	68	38-4036	52	38-5020	52	38-5088	52	38-7109	58	38-7211	64
38-0192	68	38-4038	52	38-5021	52	38-5092	52	38-7110	58	38-7212	64
38-0193	68	38-4039	52	38-5022	52	38-5093	52	38-7111	58	38-7213	64
38-0194	68	38-4040	52	38-5023	52	38-5094	52	38-7112	58	38-7214	64
38-0907	56	38-4041	52	38-5024	52	38-5096	52	38-7113	58	38-8010	60
38-0908	56	38-4042	52	38-5025	52	38-5098	52	38-7114	56	38-8012	60
38-0909	56	38-4043	52	38-5026	52	38-6030	54	38-7116	58	38-9006	70
38-1000	298	38-4044	52	38-5027	52	38-6031	54	38-7117	58	38-9008	70
38-1001	68	38-4045	52	38-5028	52	38-6032	54	38-7118	58	38-9019	72
38-1002	298	38-4046	52	38-5029	52	38-6033	54	38-7120	54	38-9020	68
38-1003	298	38-4048	52	38-5030	52	38-6034	54	38-7121	58	38-9022	66
38-1005	66	38-4049	52	38-5031	52	38-6035	54	38-7122	58	38-9023	62
38-1006	68	38-4050	52	38-5032	52	38-6036	54	38-7125	58	38-9024	58, 60
38-1007	66	38-4051	52	38-5033	52	38-6037	54	38-7126	58	38-9025	58, 60
38-1008	66	38-4052	52	38-5034	52	38-6038	54	38-7130	54	39-0626	90
38-1009	66	38-4053	52	38-5035	52	38-6050	60	38-7131	54	39-1800	90
38-1010	66	38-4054	52	38-5036	52	38-6051	60	38-7133	54	39-1820	160
38-1011	66	38-4055	52	38-5037	52	38-6052	60	38-7134	54	39-1830	126, 130
38-1012	66	38-4056	52	38-5038	52	38-6053	60	38-7140	60	39-1831	126
38-1014	66	38-4057	52	38-5039	52	38-6054	60	38-7141	60	39-1832	126
38-1015	66	38-4058	52	38-5040	52	38-6060	60	38-7142	60	39-1833	126
38-1016	66	38-5049	52	38-5041	52	38-6061	60	38-7143	60	39-2500	170
38-1017	68	38-4060	52	38-5042	52	38-6062	60	38-7144	60	39-2560	170
38-1018	68	38-4061	52	38-5043	52	38-6063	60	38-7154	60	39-2561	170
38-3100	72	38-4062	52	38-5044	52	38-6064	60	38-7155	62	39-2565	170
38-3101	72	38-4063	52	38-5045	52	38-7000	62	38-7156	62	39-2570	170
38-3102	72	38-4064	52	38-5046	52	38-7001	62	38-7157	62	39-2575	170
38-3250	38	38-4065	52	38-5047	52	38-7002	62	38-7160	62	39-2580	170
38-3300	72	38-4066	52	38-5048	52	38-7003	62	38-7161	62	39-2585	170
38-4001	52	38-4067	52	38-5049	52	38-7004	62	38-7162	62	39-2590	170
38-4002	52	38-4068	52	38-5050	52	38-7005	62	38-7163	62	39-2595	170

Series Index

41-4150	398, 438	45-0327	386	45-4058	386, 390,	45-8048	394	46-0047	404	46-0549	416
41-4155	398	45-0330	390		392	45-8050	394	46-0048	404	46-0550	410
41-4160	398	45-0332	390	45-4061	392	45-8051	394	46-0049	404	46-0551	410
41-4165	398	45-0334	390	45-4063	392	45-8052	394	46-0050	404	46-0552	410
43-0500	292	45-0400	392	45-4067	392	45-8060	394	46-0051	404	46-0553	410
43-0501	292	45-0402	392	45-4068	392	45-8061	394	46-0052	404	46-0554	410
43-0502	292	45-0403	392	45-4069	392	45-8062	394	46-0053	404	46-0555	410
43-0540	292	45-0500	390	45-4070	392	45-8063	394	46-0054	404	46-1000	410
43-0600	92	45-0501	390	45-4100	390	45-8064	394	46-0055	404	46-1020	410
43-0606	454	45-1207	528	45-4140	396	45-8065	394	46-0056	404	46-1040	410
43-0610	454	45-1208	528	45-4141	396	45-8066	394	46-0057	420	46-1060	410
43-1260	4	45-2010	398	45-4142	396	45-8067	394	46-0058	418	46-1080	410
43-1261	4	45-2020	398	45-4143	396	45-8068	394	46-0059	420	46-1100	410
43-1262	4	45-2030	398	45-4145	396	45-8800	394	46-0062	416	46-1140	410
43-1264	4	45-2040	398	45-4146	396	45-8801	394	46-0063	416	46-1200	410
43-1265	4	45-2060	396	45-4147	396	45-8802	394	46-0064	414	46-1260	410
43-1266	4	45-2080	396	45-4148	396	45-8804	394	46-0066	416	46-1500	408
43-1267	4	45-2100	396	45-4149	396	46-0000	422	46-0067	416	46-1503	408
43-1272	4	45-2120	396	45-4150	396	46-0001	402	46-0068	416	46-1520	410
43-1273	4	45-2140	396	45-4152	396	46-0002	402	46-0070	424	46-1521	410
43-1274	4	45-2160	396	45-4153	396	46-0003	402	46-0071	424	46-1522	410
43-1275	4	45-2180	398	45-4154	396	46-0004	402	46-0170	410	46-1523	410
43-1276	4	45-2200	396	45-4155	398	46-0005	402	46-0175	410	46-1524	410
43-1277	4	45-2230	400	45-4160	392	46-0006	402	46-0180	410	46-1525	410
43-1278	4	45-2231	400	45-4161	392	46-0007	402	46-0380	420	46-1526	410
43-1279	4	45-2232	400	45-4162	392	46-0008	402	46-0399	408	46-2080	416
43-1280	18, 28, 32, 98,100	45-2233	400	45-4163	392	46-0009	402	46-0400	408	46-2081	416
		45-2234	400	45-4179	398	46-0010	402	46-0401	408	46-2082	416
43-1281	32	45-2235	400	45-4190	396	46-0011	402	46-0402	408	46-2083	416
43-1282	16, 32, 98	45-2236	400	45-4191	396	46-0012	402	46-0403	408	46-2084	416
43-1283	14, 28, 32	45-2240	396	45-4194	396	46-0013	402	46-0404	422	46-2085	416
43-1284	32	45-2260	396	45-4195	396	46-0014	402	46-0405	422	46-2086	416
43-1286	32	45-2500	396	45-4997	398	46-0015	402	46-0406	414	46-2087	416
43-1288	28, 32	45-2510	396	45-4998	398	46-0016	402	46-0500	424	46-2088	416
43-1289	28, 32	45-2520	396	45-5000	398	46-0017	402	46-0501	424	46-2089	416
43-1300	24, 32	45-2530	396	45-5002	398	46-0018	402	46-0502	424	46-2090	416
43-1301	24, 32	45-3003	528	45-5004	398	46-0019	404	46-0503	424	46-2091	416
43-1302	16, 32	45-3006	528	45-6400	390	46-0020	404	46-0504	76, 424	46-2092	416
43-1303	32	45-3007	528	45-6401	390	46-0021	404	46-0507	424	46-2093	416
43-1304	32	45-3015	528	45-6402	390	46-0022	404	46-0508	76, 424	46-2400	378
43-1305	32	45-4000	390	45-6404	390	46-0023	404	46-0509	424	46-2410	378
43-1306	32	45-4001	390	45-6405	390	46-0024	404	46-0513	76, 424	46-2430	420
43-5120	392	45-4002	390	45-6409	386	46-0025	404	46-0515	74, 412	46-2600	408
43-5121	392	45-4005	390	45-6410	390	46-0026	404	46-0516	74, 412	46-2610	408
43-5122	392	45-4006	390	45-6411	390	46-0027	404	46-0520	410	46-2620	408
43-6380	522	45-4007	390	45-6412	390	46-0028	404	46-0522	410	46-2630	408
43-6400	522	45-4019	386, 394	45-6420	402	46-0029	404	46-0524	410	46-2640	408
43-6410	522	45-4020	386	45-7119	388	46-0030	404	46-0526	410	46-2650	408
43-6420	522	45-4021	386, 394	45-7120	388	46-0031	404	46-0528	410	46-2690	408
43-6421	392	45-4023	386	45-7990	398	46-0032	404	46-0530	410	46-2700	408
43-6422	392	45-4027	388	45-7995	398	46-0033	404	46-0535	408	46-2710	408
43-6423	392	45-4028	388	45-8000	394	46-0034	404	46-0536	408	46-2720	408
43-6424	392	45-4030	388	45-8001	394	46-0035	404	46-0537	408	46-2730	408
45-0130	398	45-4037	388	45-8003	394	46-0036	404	46-0538	408	46-2740	408
45-0132	398	45-4040	390	45-8009	394	46-0037	404	46-0539	412	46-2750	408
45-0135	398	45-4044	388	45-8013	394	46-0038	404	46-0540	412	46-2790	408
45-0150	388	45-4050	392	45-8016	394	46-0039	404	46-0541	412	46-2850	414
45-0312	398	45-4052	392	45-8019	394	46-0040	404	46-0542	416	46-2900	416
45-0320	390	45-4053	392	45-8024	394	46-0041	404	46-0543	416	46-2905	416
45-0321	390	45-4054	392	45-8041	394	46-0042	404	46-0544	416	46-3000	416, 428
45-0322	390	45-4055	392	45-8043	394	46-0043	404	46-0545	416	46-3002	416
45-0323	390	45-4056	392	45-8045	394	46-0044	404	46-0546	416	46-3004	416
45-0324	390	45-4057	386, 390,	45-8046	394	46-0045	404	46-0547	416	46-3006	416
45-0326	390		392	45-8047	394	46-0046	404	46-0548	416	46-3030	420

46-3050	422	46-6011	406	46-9006	414	47-3235	444	47-4069	388	47-4217	430, 434
46-3057	422	46-6012	406	46-9010	414	47-3236	444	47-4085	182	47-4218	432
46-3060	420	46-6013	406	47-2304	440	47-3241	448	47-4086	388	47-4220	434
46-3070	66, 412	46-6014	406	47-2305	440	47-3242	448	47-4087	182, 388	47-4221	430
46-3080	414	46-6015	406	47-2308	440	47-3243	448	47-4088	182	47-4222	430
46-3085	412	46-6016	406	47-2309	440	47-3244	448	47-4089	506	47-4223	430
46-3480	420	46-7000	406	47-2560	34, 104	47-3245	448	47-4090	388	47-4240	434
46-3482	418	46-7001	406	47-2580	104, 442	47-3246	444	47-4091	388, 506	47-4245	432
46-3483	418	46-7002	406	47-2590	104, 442	47-3247	444	47-4092	388	47-4250	432
46-3990	420	46-7003	406	47-2600	104, 442	47-3250	442	47-4093	388, 506	47-4251	432
46-3995	74	46-7004	406	47-2605	442	47-3255	442	47-4094	432, 506	47-4252	432
46-3998	74	46-7005	406	47-2608	104, 442	47-3257	442	47-4095	432	47-4253	432
46-3999	74	46-7006	406	47-2610	104, 442	47-3260	448	47-4096	432	47-4254	432
46-4000	420	46-7007	406	47-2700	438	47-3261	448	47-4098	506	47-4255	432
46-4002	426	46-7008	406	47-2701	438	47-3262	448	47-4099	506	47-4256	432
46-4004	420	46-7009	406	47-2708	440	47-3263	448	47-4101	182, 388	47-4399	434
46-4005	74	46-7010	406	47-2710	440	47-3264	448	47-4104	432	47-4400	434
46-4006	76	46-7011	406	47-2712	440	47-3265	448	47-4106	430	47-4401	434
46-4006	412	46-7012	406	47-2713	440	47-3266	444	47-4108	430	47-4402	434
46-4007	74	46-7013	406	47-2714	440	47-3267	448	47-4109	432	47-4403	434
46-4008	74	46-7014	406	47-2715	440	47-3270	444	47-4111	430	47-4404	434
46-4009	418	46-7015	406	47-2716	440	47-3271	444	47-4122	86	47-4405	434
46-4010	424	46-7016	406	47-2717	440	47-3274	444	47-4127	436	47-4406	434
46-4011	418	46-7017	406	47-2718	440	47-3275	444	47-4128	436	47-4407	434
46-4013	76, 426	46-7018	406	47-2719	440	47-3276	444	47-4129	436	47-4408	434
46-4014	76, 426	46-7019	406	47-2720	440	47-3280	442	47-4130	434	47-4409	434
46-4015	414	46-7020	406	47-2721	440	47-3281	442	47-4131	434	47-4752	430, 432
46-4016	414	46-7021	406	47-2722	430, 440	47-3282	442	47-4132	434	47-4753	432
46-4017	76	46-7190	408	47-2723	430, 440	47-3285	442	47-4133	434	47-4764	164
46-4018	74	46-7291	408	47-2725	440	47-3290	442	47-4140	436	47-4769	436
46-4020	426	46-7490	408	47-3060	480	47-3291	442	47-4141	436, 440	47-4780	434
46-4025	426	46-7590	408	47-3065	480	47-3297	442	47-4142	436, 440	47-4790	434
46-4026	428	46-7892	408, 500	47-3066	480	47-3299	444	47-4143	434, 440	47-4993	436
46-4028	426	46-7893	408	47-3067	480	47-3300	444	47-4144	434, 440	47-4994	436
46-4029	426	46-7894	408	47-3068	402, 480	47-3301	444	47-4145	436	47-4995	436
46-4030	428	46-7895	404	47-3085	388	47-3302	444	47-4146	436	47-4996	434
46-4035	416	46-7896	404	47-3087	388	47-3380	444	47-4147	436, 438	47-4997	434
46-4040	58	46-7897	404	47-3088	388	47-3385	444	47-4148	436, 438	47-4999	430
46-4545	204, 546	46-7898	404	47-3100	562	47-3970	432	47-4149	438	47-5000	430
46-4550	204, 546	46-7900	1, 408	47-3120	448	47-3971	432	47-4150	434, 438	47-5002	432
46-4555	204, 546	46-7901	408	47-3130	448	47-3972	432	47-4160	164	47-5003	464
46-5000	426	46-8000	410	47-3140	448	47-3973	432	47-4161	164	47-5004	464
46-5005	424, 426	46-8001	410	47-3150	448	47-3974	432	47-4162	164	47-5007	462
46-5015	426	46-8002	410	47-3151	448	47-3975	432	47-4163	164	47-5008	462
46-5016	426	46-8003	410	47-3152	448	47-3990	434	47-4164	164	47-5009	462
46-5017	426	46-8004	410	47-3153	448	47-4008	438	47-4165	164	47-5012	462
46-5018	426	46-8005	410	47-3154	448	47-4019	438	47-4166	164	47-5013	462
46-5020	426	46-8006	410	47-3155	448	47-4020	438	47-4172	434	47-5014	462
46-5060	414	46-8007	410	47-3156	448	47-4021	438	47-4176	434	47-5015	462
46-5100	414	46-8050	568	47-3200	444	47-4023	438	47-4182	432	47-5020	448
46-5120	414	46-8055	568	47-3205	444	47-4024	438	47-4183	432	47-5021	462
46-5140	414	46-8100	420	47-3210	444	47-4025	438	47-4195	434	47-5022	462
46-5160	414	46-8140	408	47-3211	444	47-4027	438	47-4196	434	47-5023	462
46-5200	414	46-8142	408	47-3215	444	47-4033	430, 432	47-4197	434	47-5024	462
46-5320	428	46-8150	408	47-3221	446	47-4039	432	47-4198	434	47-5028	462
46-6001	406	46-8152	408	47-3222	444	47-4040	432	47-4201	432	47-5029	462
46-6002	406	46-8160	408	47-3223	446	47-4043	432	47-4208	434	47-5030	448
46-6003	406	46-8160	500	47-3224	446	47-4044	434	47-4209	432	47-5032	466
46-6004	406	46-8162	408	47-3225	446	47-4046	432	47-4210	430	47-5033	466
46-6005	406	46-8163	426	47-3226	446	47-4048	432	47-4213	430	47-5034	466
46-6006	406	46-8164	428	47-3227	446	47-4049	432, 434	47-4214	430	47-5036	130
46-6007	406	46-8170	408	47-3228	446	47-4057	506	47-4215	430	47-5037	468
46-6008	406	46-9003	76, 412	47-3229	446	47-4063	432	47-4216	388, 430,	47-5038	468
46-6010	406	46-9005	414	47-3230	444	47-4064	432	506	47-5039	468	

Series Index

47-5041	462	47-5324	438	49-1005	482	49-6008	484	50-4202	482	51-4073	486, 488
47-5042	462	47-5325	438	49-1006	482	49-6010	484	50-4203	482	51-4074	486, 488
47-5043	462	47-6010	386, 388	49-1007	482	49-6011	484	50-4204	482	51-4075	486, 488
47-5044	462	47-6011	388	49-1008	482	49-6012	484	50-4205	482	51-4076	486, 488
47-5045	462	47-7000	436	49-1010	482	49-6013	484	50-4206	482	51-4080	486, 488
47-5046	462	47-7001	436	49-1011	482	49-6014	484	50-4207	482	51-4081	488
47-5047	466	47-7006	436	49-1012	482	49-6016	484	50-4208	482	51-4082	486, 488
47-5048	466	47-8002	216	49-1013	482	49-6018	484	50-4209	482	51-4083KIT	488
47-5049	468	47-8014	216	49-1014	482	49-7200	486	50-4220	482	51-4084	486, 488
47-5051	468	47-8900	572	49-1015	482	49-7210	486	50-4221	482	51-4085	536
47-5052	468	47-8910	572	49-1016	482	49-7211	486	50-4222	482	51-4090	486, 488
47-5053	466	47-8911	572	49-1018	482	49-7212	486	50-4223	482	52-0902	498
47-5054	466	47-8920	572	49-1020	482	49-7213	486	50-4224	482	52-0903	498
47-5055	462	47-8921	572	49-1022	482	49-7220	486	50-4225	482	52-0904	498
47-5057	468	47-8922	572	49-3002	484	49-7221	486	50-4226	482	52-0905	498
47-5058	462	48-0502	472	49-3003	484	49-7230	486	50-4227	482	52-0906	498
47-5061	468	48-0515	472	49-3004	484	49-7235	486	51-0000	494	52-0907	498
47-5070	464	48-0516	472	49-3006	484	49-7240	486	51-0001	494	52-0908	498
47-5075	464	48-1000	88	49-3008	484	49-7245	486	51-0560	284	52-0909	498
47-5100	464	48-1010	88	49-4001	482	49-7246	486	51-0565	284	52-0910	498
47-5105	464	48-1020	88	49-4002	482	49-7247	486	51-0569	284	52-1011	498
47-5115	464	48-1032	88	49-4003	482	49-7248	486	51-0570	284	52-1012	160, 498
47-5160	464	48-1034	88	49-4004	482	49-7249	486	51-0950	298	52-1025	498
47-5164	464	48-1035	88	49-4005	482	49-7250	486	51-0951	298	52-1026	498
47-5215	470	48-1036	218	49-4006	482	49-7251	486	51-0952	298	52-1027	498
47-5216	470	48-1041	88	49-4008	482	50-1000	482	51-0957	298	52-1028	498
47-5219	470	48-1043	218	49-4010	482	50-1001	482	51-1000	192, 208	52-1029	498
47-5220	470	48-1044	218	49-4020	482	50-1002	482	51-2005	486, 494	52-1030	498
47-5222	470	48-1045	218	49-4030	482	50-1003	482	51-2012	486, 490	52-1031	498
47-5223	470	48-1046	218	49-4040	482	50-1004	482	51-2034	492	52-1032	498
47-5224	470	48-1047	218	49-4050	482	50-1005	482	51-2036	492	52-1033	498
47-5229	470	48-1048	218	49-4060	482	50-1006	482	51-2037	492	52-1034	498
47-5230	470	48-1050	88	49-4070	482	50-1007	482	51-2040	486, 490	52-1035	498
47-5231	470	48-1060	88	49-4080	482	50-1008	482	51-2041	486, 490	52-1036	498
47-5235	470	48-1065	88	49-4100	482	50-1010	482	51-2042	486, 490	52-1037	496
47-5236	470	48-1067	88	49-4120	482	50-1011	482	51-2043	486, 490	52-1038	496
47-5237	470	48-1350	86	49-4140	482	50-1012	482	51-2060	486, 490	52-1039	496
47-5240	470	48-1800	422	49-4200	482	50-1013	482	51-2062	486, 490	52-1040	496
47-5241	470	48-1801	422	49-4201	482	50-1014	482	51-2064	486, 490	52-1041	496
47-5260	460	48-1802	422	49-4202	482	50-1015	482	51-2075	486, 494	52-1042	496
47-5261	460	48-1803	422	49-4203	482	50-1016	482	51-2076	486, 494	52-1043	496
47-5262	460	48-1804	422	49-4204	482	50-1018	482	51-2077	486, 490	52-1045	496
47-5263	460	48-1806	422	49-4205	482	50-1020	482	51-2089	486, 490	52-1046	496
47-5264	460	48-2300	544	49-4206	482	50-1022	482	51-2094	486, 492	52-1054	496
47-5265	460	48-3000	510	49-4207	482	50-4001	482	51-2095	486, 492	52-1055	496
47-5266	460	48-4000	88	49-4208	482	50-4002	482	51-2096	486, 492	52-1056	496
47-5267	460	48-7510	472	49-4209	482	50-4003	482	51-2097	486, 492	52-1057	496
47-5268	460	48-7512	472	49-4220	482	50-4004	482	51-2098	486, 492, 494	52-1058	496
47-5269	460	48-7520	472	49-4221	482	50-4005	482	51-2102	486, 492	52-1059	496
47-5296	438	48-7525	288	49-4222	482	50-4006	482	51-2105	486, 490	52-1060	496
47-5299	438	48-7526	288	49-4223	482	50-4008	482	51-2106	486, 490	52-1065	496
47-5300	438	48-7530	472	49-4224	482	50-4010	482	51-2108	486, 490	52-1066	496, 498
47-5301	438	48-7535	472	49-4225	482	50-4020	482	51-2109	486, 490	52-1070	496
47-5304	438	48-7540	472	49-4226	482	50-4030	482	51-2110	486, 490	52-5140	498
47-5305	438	48-7550	472	49-4227	482	50-4040	482	51-2111	486, 490	52-5400	496
47-5306	438	49-0995	484	49-4300	484	50-4050	482	51-2112	490	52-5401	496
47-5307	438	49-0996	484	49-6000	484	50-4060	482	51-2300	492	52-5406	496
47-5308	438	49-0997	484	49-6001	484	50-4070	482	51-4060	486, 494	52-5408	496
47-5309	438	49-0998	484	49-6002	484	50-4080	482	51-4061	486, 494	52-5410	496
47-5310	438	49-1000	482	49-6003	484	50-4100	482	51-4062	486, 494	52-5412	496
47-5311	438	49-1001	482	49-6004	484	50-4120	482	51-4068	486, 488	52-5414	496
47-5312	438	49-1002	482	49-6005	484	50-4140	482	51-4069	486, 488	52-5416	496
47-5313	438	49-1003	482	49-6006	484	50-4200	482	51-4070	486, 488	52-5420	496
47-5319	438	49-1004	482	49-6007	484	50-4201	482	51-4072	486, 488	52-5425	496

52-5430	496	53-1203	218	54-1818	522	54-4413	188, 524	54-8000	38	55-2559	378
52-5440	498	53-1206	218	54-1819	522	54-4414	188, 524	54-8020	524	55-2560	378
52-5445	498	53-1207	218	54-1880	518	54-4415	526	54-8021	524	55-2561	378
52-5450	498	53-1208	218	54-1881	518	54-4416	524	54-8025	164	55-2562	378
52-5470	496	53-1209	218	54-1882	518	54-4417	524	54-8026	164	55-2622	378
52-5500	496	53-1210	218	54-1888	520	54-4418	524	54-8027	164	55-2623	378
52-5501	496	53-1211	218	54-1890	518	54-4419	182	54-8030	524	55-2722	378
52-5502	496	53-1212	218	54-1891	518	54-4425	194	54-8031	524	55-2723	378
52-5503	496	53-1213	218	54-1892	518	54-4427	164	54-8035	524	55-2922	378
52-5504	496	53-1216	218	54-1894	520	54-4430	194	54-8036	524	55-2923	378
52-5505	496	53-1400	88	54-1895	520	54-4431	528	54-8040	164, 398	55-3022	378
52-5506	496	53-1402	88	54-1896	520	54-4432	188	54-8041	164, 398	55-3023	378
52-5507	496	53-1406	88	54-1900	518	54-4432	524	54-8042	164, 398	55-3122	378
52-5508	496	53-1409	94	54-1901	518	54-4433	188, 524	54-8043	164, 398	55-3123	378
52-9500	162, 246	53-1412	94	54-1902	518	54-4435	528	54-8070	524	55-3222	378
52-9501	246	53-1425	94	54-1904	518	54-4439	202	54-8071	524	55-3223	378
52-9502	246	53-1425	94	54-1905	518	54-4444	206	54-8072	524	55-3230	378
52-9504	246	53-1440	88	54-1906	518	54-4445	164	54-8075	526	55-3322	378
52-9505	246	53-1442	88	54-1910	518	54-4447	202	54-8076	526	55-3335	378
52-9506	246	53-1725	92	54-1911	518	54-4450	200	54-8077	526	55-3336	378
52-9507	246	53-1726	92	54-1912	518	54-4451	200	54-8078	526	55-3340	378
52-9660	162, 246	53-1901	94	54-2520	188	54-4452	200	54-8080	526	56-0805	536
53-0200	72	53-1905	272	54-4000	526	54-4453	470	54-8081	526	56-0806	536
53-0201	72	53-1905	272	54-4002	526	54-4455	200	54-8082	526	56-0807	536
53-0202	72	53-2800	76, 422	54-4004	526	54-4458	202	54-8083	526	56-0809	536
53-0203	72	53-2801	76	54-4006	526	54-4462	206, 478	54-8089	526	56-7006	536
53-0215	72	53-6200	76, 422	54-4008	526	54-4463	470	54-8090	526	56-7007	536
53-0601	84	53-6201	424	54-4010	364, 526	54-4468	206	54-8100	342	56-7100	536
53-0603	84	53-8000	426	54-4011	526	54-4470	206	54-8102	342	56-7101	536
53-0700	238	53-8030	426	54-4015	522	54-4474	518	54-8104	342	56-7102	536
53-1000	92	53-8060	424	54-4020	524	54-4476	202	54-8106	342	56-7130	536
53-1001	92	53-8070	422	54-4022	524	54-4478	206	54-8108	342	56-7131	536
53-1002	92	53-9309	428	54-4024	524	54-4479	206	54-9000	142	56-7140	536
53-1003	92	53-9310	428	54-4026	526	54-4490	206	54-9002	142	56-7600	534
53-1004	92	53-9326	428	54-4030	526	54-4491	206	54-9010	164	56-7601	534
53-1005	92	54-0500	506	54-4031	526	54-4492	206	54-9012	164	56-7602	532
53-1006	92	54-0801	518	54-4034	526	54-4493	206	54-9029	206	56-7603	534
53-1007	92	54-0802	520	54-4035	522	54-4520	206	54-9030	206	56-7605	534
53-1008	92	54-1100	520	54-4036	164, 522	54-4535	184, 512	54-9031	206	56-7606	534
53-1009	92	54-1101	520	54-4037	164, 522	54-4536	184, 512	54-9032	206	56-7607	392
53-1010	92	54-1104	522	54-4038	164, 522	54-4537	184, 512	54-9033	206	56-7608	532
53-1011	92	54-1105	522	54-4039	392, 528	54-4538	184, 512	54-9034	206	56-7609	532
53-1012	92	54-1108	520	54-4050	524	54-4545	528	54-9035	206	56-7610	532
53-1013	92	54-1109	520	54-4055	528	54-4560	518	54-9036	206	56-7611	534
53-1014	92	54-1112	520	54-4060	528	54-4567	506	54-9037	206	56-7612	534
53-1015	92	54-1113	520	54-4102	478	54-4568	506	55-2401	378	56-7613	532
53-1021	92	54-1115	506	54-4200	292	54-4569	506	55-2402	378	56-7618	532
53-1022	92	54-1116	506	54-4391	202	54-4571	506	55-2403	378	56-7620	534
53-1023	92	54-1117	506	54-4392	202	54-4580	510	55-2407	378	56-7621	534
53-1024	92	54-1118	506	54-4393	202	54-4581	510	55-2522	378	56-7622	534
53-1025	92	54-1119	506	54-4394	202	54-4600	510	55-2523	378	56-7630	534
53-1026	92	54-1120	522	54-4395	202	54-5005	398	55-2540	378	56-7635	534
53-1027	92	54-1121	506	54-4396	200	54-5020	528	55-2541	378	56-7640	534
53-1028	92	54-1122	506	54-4397	202	54-5022	528	55-2542	378	56-7647	534
53-1029	92	54-1200	510, 522	54-4400	202	54-5030	398	55-2543	378	56-7648	534
53-1030	92	54-1201	510, 522	54-4401	202	54-5031	398	55-2550	378	56-7649	534
53-1031	92	54-1784	520	54-4402	202	54-5033	398	55-2551	378	56-7650	534
53-1032	92	54-1785	520	54-4403	202	54-5500	526	55-2552	378	56-7711	530
53-1033	92	54-1791	520	54-4404	202	54-5602	168	55-2553	378	56-7712	530
53-1034	92	54-1800	520	54-4405	202	54-5605	168	55-2554	378	56-7713	530
53-1035	92	54-1805	522	54-4407	202	54-5801	172	55-2555	378	56-7800	532
53-1040	92	54-1810	522	54-4408	202	54-5802	172	55-2556	378	56-7804	532
53-1200	218	54-1815	522	54-4409	342	54-5803	172	55-2557	378	56-7805	532
53-1201	218	54-1817	522	54-4411	188	54-7000	522	55-2558	378	56-7806	532

Series Index

56-7807	532	57-6033	538	57-6350	544	58-2462	484	59-0653	568	59-1320	558
56-7820	532	57-6037	546	57-7300	548	58-2465	484	59-0654	568	59-1321	558
56-7830	530	57-6038	546	57-7301	548	58-2470	484	59-0655	568	59-1322	558
56-7831	530	57-6039	548	57-7302	548	58-2500	560	59-0656	568	59-1323	558
56-7832	530	57-6040	540	57-7303	548	58-2501	560	59-0657	568	59-1344	558
56-7833	530	57-6041	540	57-7304	548	58-2502	560	59-0659	568	59-1345	558
56-7835	530	57-6042	540	57-7305	548	58-2503	558	59-0790	576	59-1346	558
56-7836	530	57-6043	540	57-7306	548	58-2505	558	59-0793	576	59-1347	558
56-7837	530	57-6050	538	57-7307	548	58-2540	562	59-0794	576	59-1348	558
56-7840	534	57-6052	540	57-7310	548	58-2541	562	59-0795	576	59-1349	558
56-8000	536	57-6060	538	57-7401	544	58-2542	562	59-0796	576	59-1350	558
56-8001	536	57-6062	540	57-7402	544	58-2550	562	59-0797	572	59-1351	558
56-8010	536	57-6070	538	57-7403	544	58-2551	562	59-0798	576	59-1352	558
56-8014	536	57-6072	540	57-7404	544	58-2552	562	59-0799	576	59-1353	558
56-8018	536	57-6080	538	57-7500	548	58-2553	562	59-0800	572	59-1354	558
56-8022	536	57-6082	540	57-7505	544	58-2554	198	59-0804	576	59-1355	558
56-8030	536	57-6085	540	57-7510	204, 546	58-2555	562	59-0805	574	59-1356	558
56-9000	536	57-6086	540	57-7515	204, 546	58-2556	562	59-0806	574	59-1357	558
56-9001	536	57-6087	540	57-7516	204, 546	58-2557	562	59-0807	572	59-1358	558
57-0400	542	57-6088	540	57-7517	204, 546	58-2558	562	59-0808	572	59-1359	558
57-0410	540	57-6130	540	57-7518	204, 546	58-2559	182	59-0809	576	59-1360	558
57-0411	540	57-6140	540	57-7519	204, 546	58-2603	578	59-0810	572	59-1361	558
57-0420	74, 542	57-6150	540	57-7520	546	58-2650	578	59-0811	572	59-1362	558
57-0430	542	57-6151	540	57-7521	546	58-2700	566	59-0812	572	59-1363	558
57-0440	542	57-6152	540	57-7522	546	58-2701	566	59-0813	572	59-1500	558
57-0450	548	57-6160	540	57-7525	548, 570	58-2702	566	59-0815	572	59-2000	558
57-0451	548	57-6161	540	57-7530	544	58-2703	566	59-0900	574	59-2010	558
57-0455	538	57-6162	540	57-7600	518, 546	58-2704	566	59-0901	574	59-2020	558
57-0560	376	57-6163	540	57-7610	546	58-2705	564	59-0902	574	59-2030	558
57-0570	542	57-6164	540	57-7615	518, 546	58-2799	578	59-0903	574	59-2050	556
57-0571	542	57-6165	540	57-7620	546	58-2800	578	59-0904	574	59-2051	556
57-0572	542	57-6170	542	57-7625	438, 546	58-2801	578	59-0905	574	59-2051	556
57-0573	542	57-6171	542	57-7630	546	58-2805	562	59-0906	574	59-2100	70, 564
57-0574	542	57-6172	542	57-7635	542	59-0280	52	59-1000	52	59-2105	70, 564
57-0580	376	57-6173	542	57-7636	542	59-0300	572	59-1039	30	59-2110	70, 564
57-0581	376, 428	57-6174	542	57-7640	66, 548	59-0402	576	59-1050	560	59-2115	70, 564
57-0680	178	57-6178	542	57-7657	544	59-0405	576	59-1052	560	59-2500	50, 566
57-0690	528, 544	57-6179	542	57-7658	544	59-0406	576	59-1054	560	59-2600	50, 566
57-0691	528, 544	57-6180	540	57-7660	74, 540	59-0410	570	59-1056	560	59-3000	52
57-5010	542	57-6181	540	57-7770	506	59-0411	570	59-1060	560	59-3002	52
57-5015	542	57-6182	538	57-9200	204, 546	59-0470	570	59-1061	560	59-3005	568
57-5020	548	57-6183	538	58-1030	98	59-0472	570	59-1062	560	60-7073	564
57-5025	542	57-6184	538	58-1400	216	59-0473	570	59-1064	560	60-7074	564
57-5030	74, 542	57-6185	538	58-1412	376	59-0475	570	59-1065	560	60-7075	564
57-5035	542	57-6186	538	58-2200	216	59-0476	570	59-1300	558	60-7076	564
57-5042	542	57-6187	538	58-2400	216	59-0477	570	59-1301	558	61-0281	132
57-5046	542	57-6188	538	58-2410	216	59-0482	566	59-1302	558	61-0283	132
57-6000	544	57-6189	538	58-2422	98	59-0483	566	59-1303	558	61-0299	132
57-6001	538	57-6190	538	58-2423	98	59-0484	578	59-1304	558	61-0517	300
57-6002	538	57-6191	538	58-2424	98	59-0487	568	59-1305	558	61-0518	300
57-6013	74, 542	57-6192	538	58-2430	96	59-0488	52, 570	59-1306	558	61-0519	300
57-6015	544	57-6193	538	58-2432	96	59-0550	568	59-1307	558	61-0535	300
57-6016	544	57-6194	540	58-2434	96	59-0555	568	59-1308	558	61-0536	300
57-6017	544	57-6195	540	58-2434	216	59-0560	568	59-1309	558	61-0537	300
57-6018	74, 542	57-6196	540	58-2436	78	59-0561	568	59-1310	558	61-0538	300
57-6021	544	57-6197	540	58-2436	96	59-0562	568	59-1311	558	61-0540	300
57-6025	538	57-6198	540	58-2437	96	59-0563	568	59-1312	558	61-0544	300
57-6026	538	57-6200	544	58-2438	98	59-0564	568	59-1313	558	61-0546	300
57-6027	538	57-6201	544	58-2439	244	59-0565	568	59-1314	558	61-0547	298
57-6028	538	57-6250	538	58-2440	422, 474	59-0645	568	59-1315	558	61-0548	298
57-6029	538	57-6260	538	58-2450	216	59-0646	568	59-1316	558	61-0552	300
57-6030	538	57-6270	538	58-2452	216	59-0650	568	59-1317	558	61-0554	300
57-6031	538	57-6280	546	58-2454	216	59-0651	568	59-1318	558	61-1331	40
57-6032	538	57-6281	546	58-2456	216	59-0652	568	59-1319	558	61-1332	40

61-1333	40	62-1246	300	62-4542	550	77-1019	110	77-1145	110	77-1414	112
61-1334	40	62-1247	300	62-4543	550	77-1020	110	77-1147	110	77-1415	112
61-1335	40	62-1248	300	62-4544	550	77-1021	110	77-1150	110	77-1416	112
61-1336	40	62-4385	550	62-4545	550	77-1022	110	77-1197	110	77-1417	112
61-1510	42, 564	62-4388	550	62-4546	550	77-1023	110	77-1198	110	77-1418	112
61-1520	42, 564	62-4389	550	62-4550	550	77-1024	110	77-1199	110	77-1419	112
61-1530	42, 564	62-4391	552	62-4590	550	77-1025	110	77-1209	110	77-1420	112
61-1540	42, 564	62-4393	552	62-4591	550	77-1026	110	77-1210	110	77-1421	112
61-1550	42, 564	62-4395	552	62-4592	550	77-1027	110	77-1211	110	77-1422	112
61-1555	42, 564	62-4396	550	62-4600	552	77-1028	110	77-1212	110	77-1423	112
61-1556	42, 564	62-4397	552	62-4601	552	77-1029	110	77-1213	110	77-1424	112
61-1557	42, 564	62-4399	552	62-4602	550	77-1030	110	77-1214	110	77-1425	112
61-1558	42, 564	62-4401	552	62-4603	550	77-1031	110	77-1215	110	77-1427	112
61-1559	42, 564	62-4403	68	62-4621	550	77-1033	110	77-1216	110	77-1429	112
61-1560	42	62-4403	550	62-5100	504	77-1035	110	77-1217	110	77-1430	112
61-1595	42	62-4409	550	62-5502	548	77-1037	110	77-1218	110	77-1431	112
61-1596	42	62-4413	552	64-4010	204	77-1040	110	77-1219	110	77-1433	112
61-1597	42	62-4421	552	64-4077	566	77-1042	110	77-1220	110	77-1435	112
61-1598	42	62-4422	552	64-4078	566	77-1045	110	77-1221	110	77-1437	112
61-1599	42	62-4423	552	64-4079	576	77-1047	110	77-1222	110	77-1440	112
61-1600	42	62-4427	552	64-4080	566	77-1050	110	77-1223	110	77-1442	112
61-1601	42	62-4428	550	64-4085	572	77-1055	110	77-1225	110	77-1445	112
61-1602	42	62-4430	550	64-4090	572	77-1060	110	77-1227	110	77-1447	112
61-1603	42	62-4432	548	64-5000	572	77-1065	110	77-1229	110	77-1450	112
61-1604	42	62-4433	552	64-5003	572	77-1070	110	77-1231	110	77-1460	112
61-1630	42	62-4434	550	64-5004	572	77-1075	110	77-1233	110	77-1470	112
61-1635	42	62-4435	552	64-5008	572	77-1080	110	77-1235	110	77-1480	112
61-1640	42	62-4436	550	64-5009	572	77-1085	110	77-1237	110	77-1497	112
61-1645	42	62-4437	548	64-5010	576	77-1090	110	77-1245	110	77-1498	112
61-1646	42	62-4440	548	64-5100	562	77-1095	110	77-1247	110	77-1499	112
61-1647	42	62-4442	150	64-5102	570	77-1096	110	77-1299	110	77-1506	108
61-1648	42	62-4445	550	64-5104	570	77-1097	110	77-1309	112	77-1507	108
61-1649	300	62-4446	550	64-5105	570	77-1098	110	77-1310	112	77-1508	108
61-1655	42, 300	62-4447	552	64-5106	52	77-1099	110	77-1311	112	77-1509	108
61-1660	42	62-4449	552	64-5107	52	77-1105	110	77-1312	112	77-1510	108
61-1700	42	62-4453	552	64-5112	562	77-1106	110	77-1313	112	77-1512	108
61-1710	300	62-4454	548	64-5116	564	77-1107	110	77-1314	112	77-1514	108
61-1740	294	62-4455	552	64-6496	428	77-1108	110	77-1315	112	77-1515	108
61-1741	294	62-4459	548	69-1101	460	77-1109	110	77-1316	112	77-1516	108
61-1742	294	62-4460	550	69-1102	460	77-1110	110	77-1317	112	77-1518	108
61-1743	294	62-4463	550	69-1103	460	77-1111	110	77-1318	112	77-1521	108
61-3000	298	62-4464	550	69-1104	460	77-1112	110	77-1319	112	77-1523	108
61-3010	298	62-4465	550	77-1001S	118	77-1113	110	77-1320	112	77-1525	108
61-3020	298	62-4466	552	77-1002S	118	77-1114	110	77-1322	112	77-1527	108
61-3030	298	62-4467	550	77-1003	110	77-1115	110	77-1323	112	77-1529	108
61-5403	554	62-4471	552	77-1003S	118	77-1116	110	77-1325	112	77-1531	108
61-5407	554	62-4475	550	77-1004	110	77-1117	110	77-1327	112	77-1533	108
61-5408	554	62-4476	552	77-1005	110	77-1118	110	77-1330	112	77-1535	108
61-5411	554	62-4478	552	77-1005S	118	77-1119	110	77-1331	112	77-1537	108
61-5412	554	62-4479	548	77-1006	110	77-1120	110	77-1333	112	77-1540	108
61-5413	554	62-4482	550	77-1006S	118	77-1121	110	77-1335	112	77-1542	108
61-5415	554	62-4486	550	77-1007	110	77-1122	110	77-1337	112	77-1545	108
61-6491	554	62-4488	552	77-1007S	118	77-1123	110	77-1340	112	77-1547	108
61-6493	554	62-4497	550	77-1008	110	77-1124	110	77-1345	112	77-1550	108
61-6494	554	62-4498	550	77-1009	110	77-1125	110	77-1350	112	77-1560	108
61-9424	460	62-4499	550	77-1010	110	77-1127	110	77-1370	112	77-1608	108
62-0040	300	62-4500	550	77-1011	110	77-1129	110	77-1380	112	77-1609	108
62-0044	300	62-4503	550	77-1012	110	77-1130	110	77-1390	112	77-1610	108
62-1240	300	62-4507	550	77-1013	110	77-1131	110	77-1396	112	77-1612	108
62-1241	300	62-4511	548	77-1014	110	77-1133	110	77-1398	112	77-1614	108
62-1242	300	62-4513	548	77-1015	110	77-1135	110	77-1409	112	77-1616	108
62-1243	300	62-4514	548	77-1016	110	77-1137	110	77-1410	112	77-1618	108
62-1244	300	62-4540	550	77-1017	110	77-1140	110	77-1412	112	77-1620	108
62-1245	300	62-4541	550	77-1018	110	77-1142	110	77-1413	112	77-1621	108

Series Index

77-1622	108	77-2212	114	77-2901	92	77-5113	114	77-6223	214
77-1623	108	77-2213	114	77-2902	92	77-5114	114	77-6306	116
77-1625	108	77-2214	114	77-2903	92	77-5115	114	77-6308	116
77-1627	108	77-2215	114	77-2904	92	77-5116	114	77-6309	116
77-1629	108	77-2216	114	77-2905	92	77-5117	114	77-6310	116
77-1630	108	77-2218	114	77-2906	92	77-5118	114	77-6312	116
77-1631	108	77-2221	114	77-2907	92	77-5119	114	77-6314	116
77-1640	108	77-2223	114	77-2908	92	77-5120	114	77-6316	116
77-1706	112	77-2225	114	77-2909	92	77-5121	114	77-6408	114, 116
77-1707	112	77-2240	114	77-2910	92	77-5122	114	77-6409	114, 116
77-1708	112	77-2310	110	77-2911	92	77-5123	114	77-6412	114, 116
77-1709	112	77-2312	110	77-2912	92	77-5212	114	77-6509	116
77-1710	112	77-2506	212	77-2913	92	77-5214	114	77-6510	116
77-1712	112	77-2507	212	77-2914	92	77-5216	114	77-6512	116
77-1714	112	77-2508	214	77-2915	92	77-5308	114	77-6516	116
77-1716	112	77-2509	214	77-2916	92	77-5309	114	77-6521	116
77-1718	112	77-2510	214	77-2917	92	77-5310	114	77-6709	114
77-1721	112	77-2512	214	77-2918	92	77-5409	114, 116	77-6710	114
77-1723	112	77-2514	214	77-2919	92	77-5410	114, 116	77-6712	114
77-1725	112	77-2605	214	77-2920	92	77-5412	114, 116	77-6714	114
77-1727	112	77-2606	214	77-2921	92	77-5414	114, 116	77-6810	114
77-1728	112	77-2607	214	77-2922	92	77-5416	114, 116	77-6812	114
77-1740	112	77-2608	214	77-2930	92	77-5421	114, 116	77-6816	114
77-1806	112	77-2609	214	77-2931	92	77-5509	114, 116	77-6909	116
77-1807	112	77-2610	214	77-2940	92	77-5510	114, 116	77-6910	116
77-1808	112	77-2611	214	77-3008	118	77-5512	114, 116	80-0000	50
77-1809	112	77-2612	214	77-3010	118	77-5516	114, 116	80-0001	50
77-1810	112	77-2613	214	77-3012	124	77-5709	114, 116	80-0002	50
77-1812	112	77-2614	214	77-3014	124	77-5710	114, 116	80-0003	50
77-1814	112	77-2615	214	77-3016	118	77-5810	114, 116	90-0000	40
77-1816	112	77-2616	214	77-3018	118	77-5812	114, 116	90-0100	40
77-1818	112	77-2617	214	77-3108	118	77-5816	114, 116	90-0200	40
77-1821	112	77-2618	214	77-3109	118	77-5908	116	90-0300	40
77-1823	112	77-2620	214	77-3110	118	77-5909	116	90-1000	40
77-1825	112	77-2621	214	77-3111	118	77-5910	116		
77-1827	112	77-2622	214	77-3112	118	77-5912	116		
77-1829	112	77-2623	214	77-3113	118	77-5914	116		
77-1840	112	77-2699	214	77-3114	118	77-5916	116		
77-1915	112	77-2808	118	77-3115	118	77-5918	116		
77-1920	112	77-2809	118	77-3116	118	77-6108	116		
77-2023	112	77-2810	118	77-3117	118	77-6109	116		
77-2029	112	77-2811	118	77-3118	118	77-6110	116		
77-2035	112	77-2812	118	77-3121	118	77-6112	116		
77-2040	112	77-2813	118	77-3123	118	77-6114	116		
77-2106	114	77-2814	118	77-3240	114	77-6116	116		
77-2107	114	77-2815	118	77-3250	114	77-6118	116		
77-2108	114	77-2816	118	77-3260	114	77-6205	214		
77-2109	114	77-2817	118	77-3270	114	77-6206	214		
77-2110	114	77-2818	118	77-3280	114	77-6207	214		
77-2112	114	77-2819	118	77-3340	114	77-6208	214		
77-2114	114	77-2820	118	77-3350	114	77-6209	214		
77-2116	114	77-2821	118	77-4123	126	77-6210	214		
77-2118	114	77-2823	118	77-4131	126	77-6211	214		
77-2121	114	77-2825	118	77-4151	126	77-6212	214		
77-2123	114	77-2827	118	77-5103	114	77-6213	214		
77-2125	114	77-2829	118	77-5104	114	77-6214	214		
77-2127	114	77-2830	118	77-5105	114	77-6215	214		
77-2140	114	77-2835	118	77-5106	114	77-6216	214		
77-2206	114	77-2840	118	77-5107	114	77-6217	214		
77-2207	114	77-2845	118	77-5108	114	77-6218	214		
77-2208	114	77-2850	118	77-5109	114	77-6219	214		
77-2209	114	77-2898	118	77-5110	114	77-6220	214		
77-2210	114	77-2899	118	77-5111	114	77-6221	214		
77-2211	114	77-2900	92	77-5112	114	77-6222	214		



Stuller.com | 800 877 7777